



US00D707384S

(12) **United States Design Patent**
Hulse

(10) **Patent No.:** **US D707,384 S**
(45) **Date of Patent:** **** Jun. 17, 2014**

(54) **REFLECTOR**

(71) Applicant: **SoundOff Signal, Inc.**, Hudsonville, MI
(US)

(72) Inventor: **George Robert Hulse**, Hudsonville, MI
(US)

(73) Assignee: **SoundOff Signal, Inc.**, Hudsonville, MI
(US)

(**) Term: **14 Years**

(21) Appl. No.: **29/462,918**

(22) Filed: **Aug. 9, 2013**

(51) **LOC (10) Cl.** **26-99**

(52) **U.S. Cl.**
USPC **D26/118**

(58) **Field of Classification Search**
USPC D26/63, 120, 118, 113, 119, 121, 122,
D26/123, 65, 66, 68, 124, 125, 72, 76, 1, 2,
D26/128, 69, 74, 88, 89, 87, 61, 92, 98, 93,
D26/86; 362/158, 240, 260, 235, 249.02,
362/249.11, 294, 364, 335; D13/179, 180
See application file for complete search history.

(56) **References Cited**

U.S. PATENT DOCUMENTS

D203,405 S * 1/1966 Crawford D26/90
D206,021 S * 10/1966 Carter D26/121
D316,301 S * 4/1991 Michael D26/24
D405,209 S * 2/1999 Walz D26/86

D447,272 S * 8/2001 Smith D26/118
6,705,746 B2 * 3/2004 Perlo et al. 362/290
D492,438 S * 6/2004 O'Tierney D26/80
D597,705 S * 8/2009 Mitani et al. D26/122
D644,784 S * 9/2011 Monteix et al. D26/138
D652,559 S * 1/2012 Beghelli D26/74
D659,895 S * 5/2012 Maxik et al. D26/118
D667,987 S * 9/2012 Cai D26/122
D668,378 S * 10/2012 Cai D26/122

* cited by examiner

Primary Examiner — Kevin Rudzinski

(74) *Attorney, Agent, or Firm* — McGarry Bair PC

(57) **CLAIM**

The ornamental design for a reflector, as shown and described.

DESCRIPTION

FIG. 1 is a bottom, front, right perspective view of a reflector which embodies my design;
FIG. 2 is a top right front perspective view thereof;
FIG. 3 is a front view thereof;
FIG. 4 is a rear view thereof;
FIG. 5 is a right side view thereof, the left side view is a mirror image thereof;
FIG. 6 is a sectional view along lines 6-6 of FIG. 3.
FIG. 7 is a top view thereof; and,
FIG. 8 is a bottom view thereof.
The environmental structure shown in broken lines forms no part of the claimed design. All portions shown in broken lines that do not include surface shading form no part of the claimed design.

1 Claim, 4 Drawing Sheets

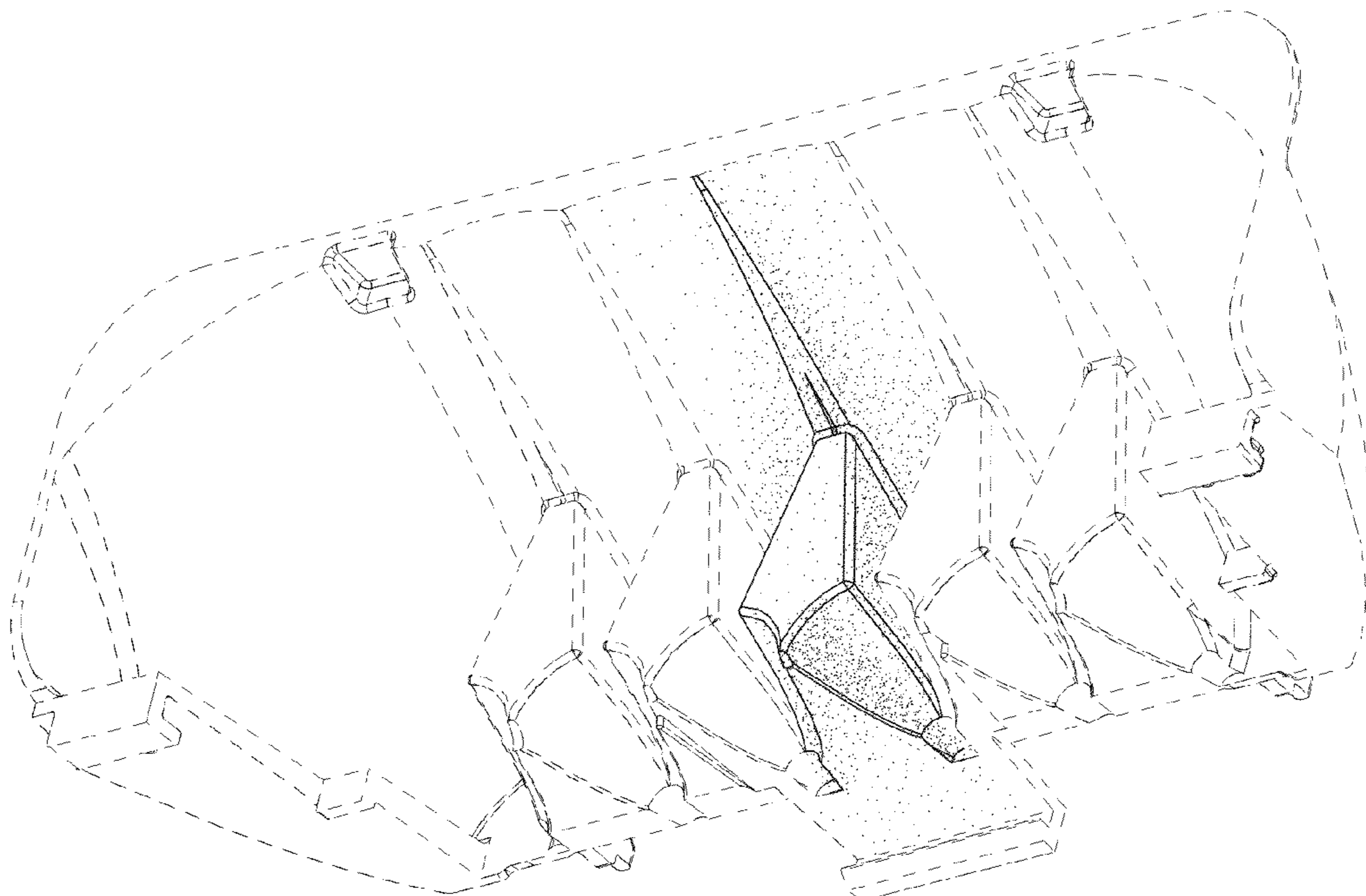

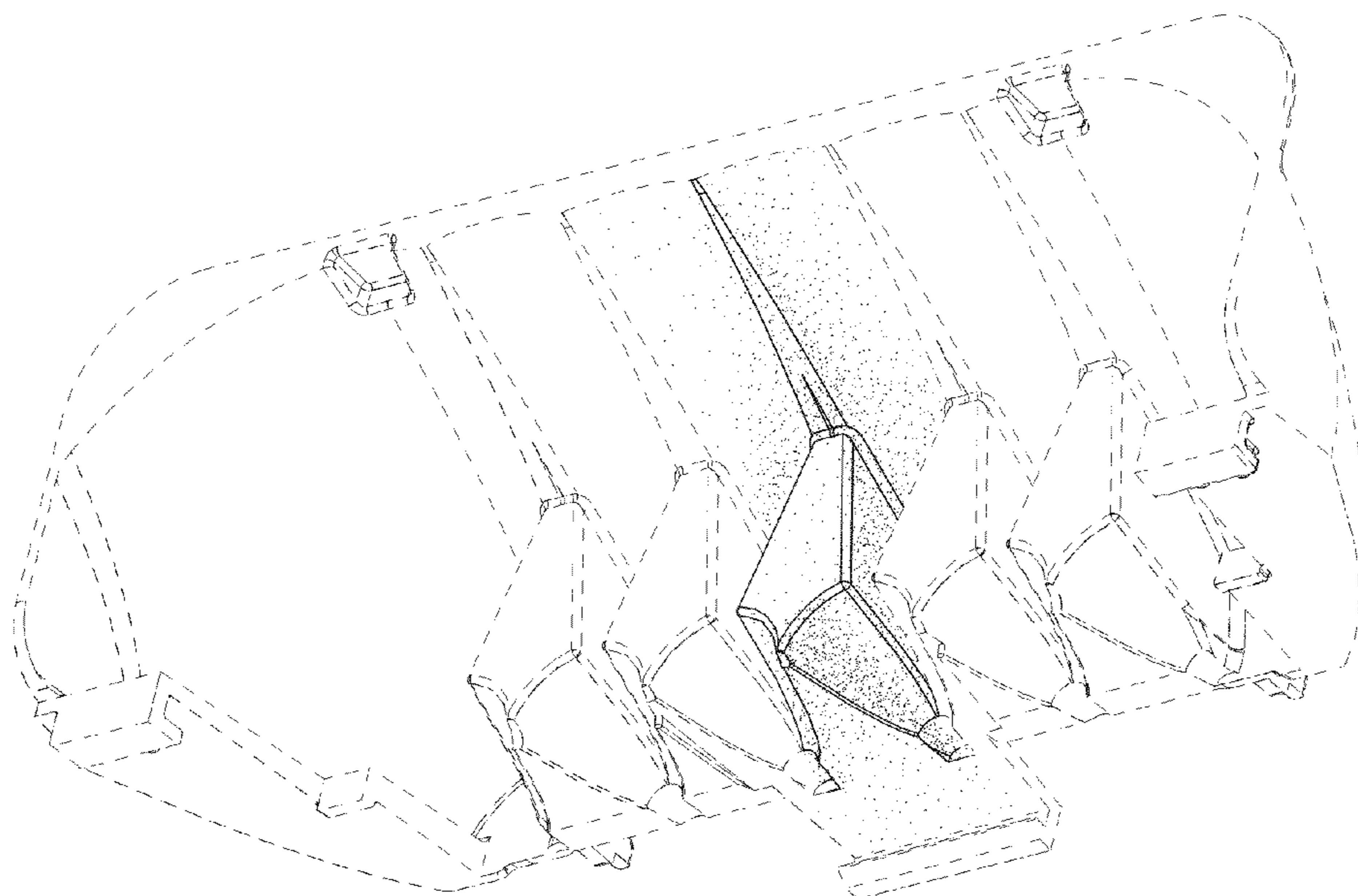

FIG. 1

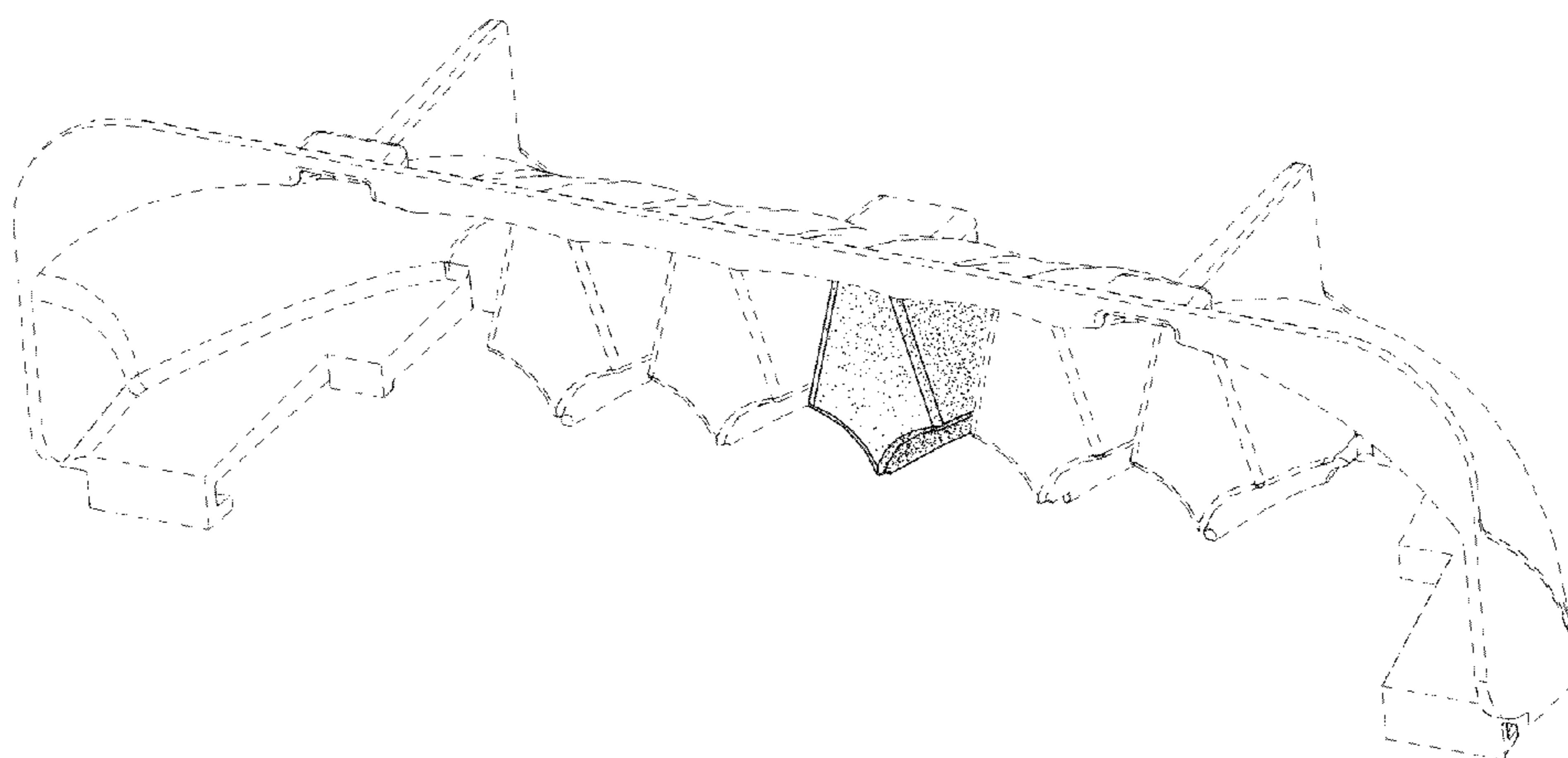

FIG. 2

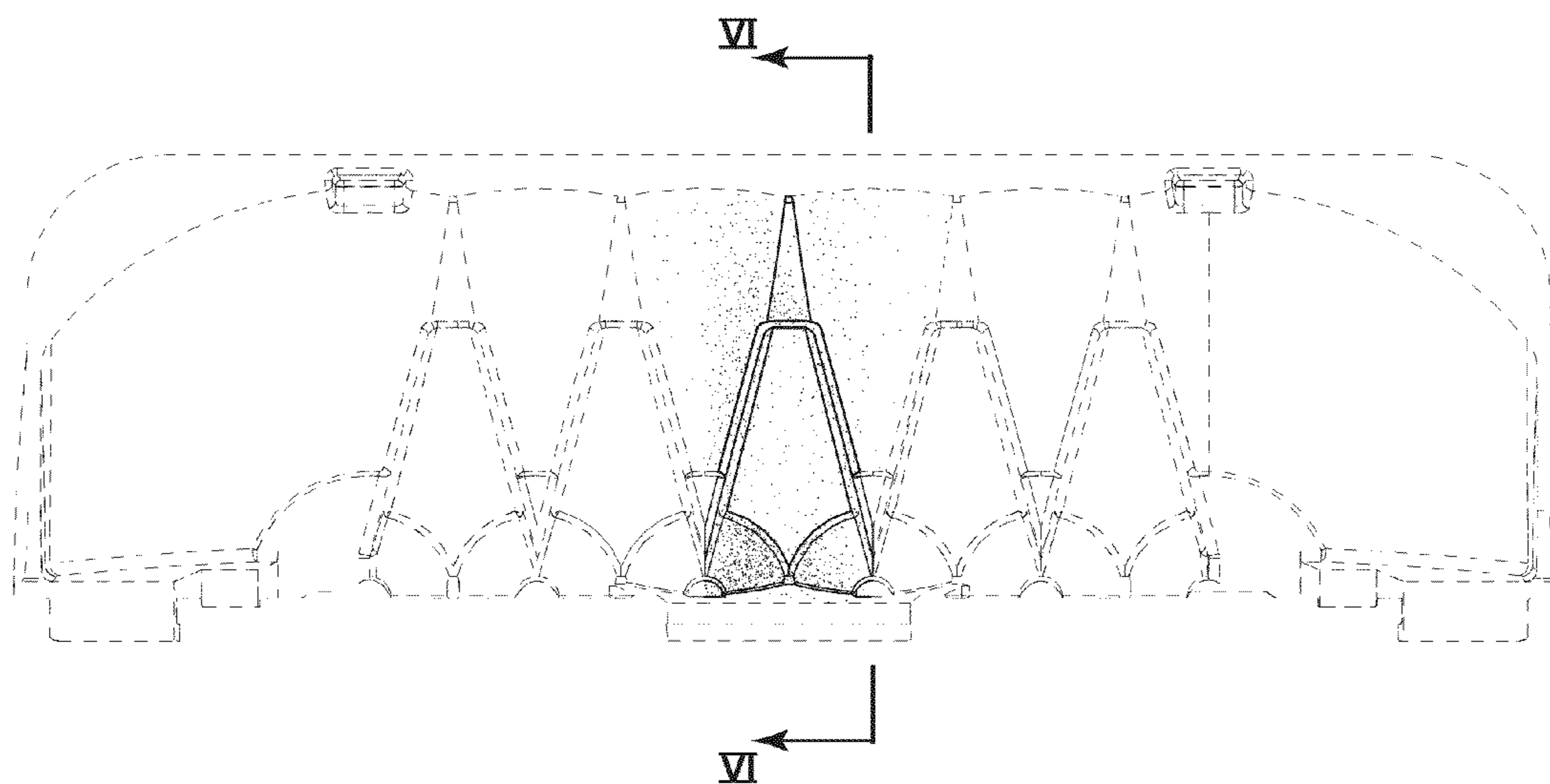

FIG. 3

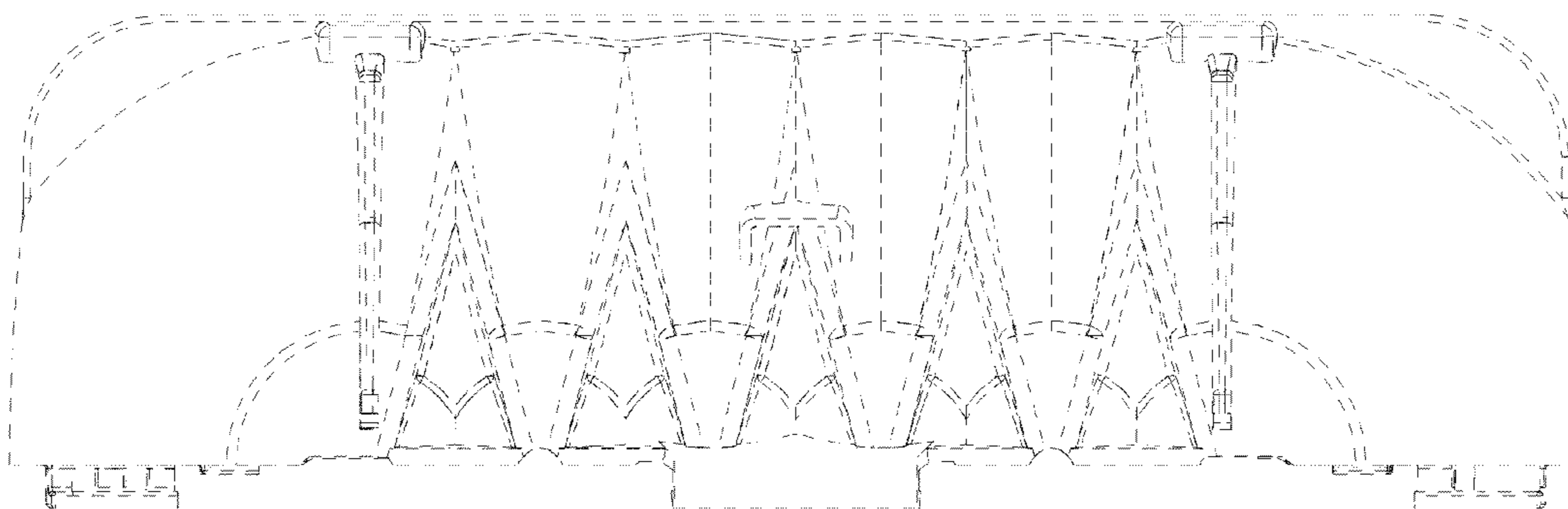

FIG. 4

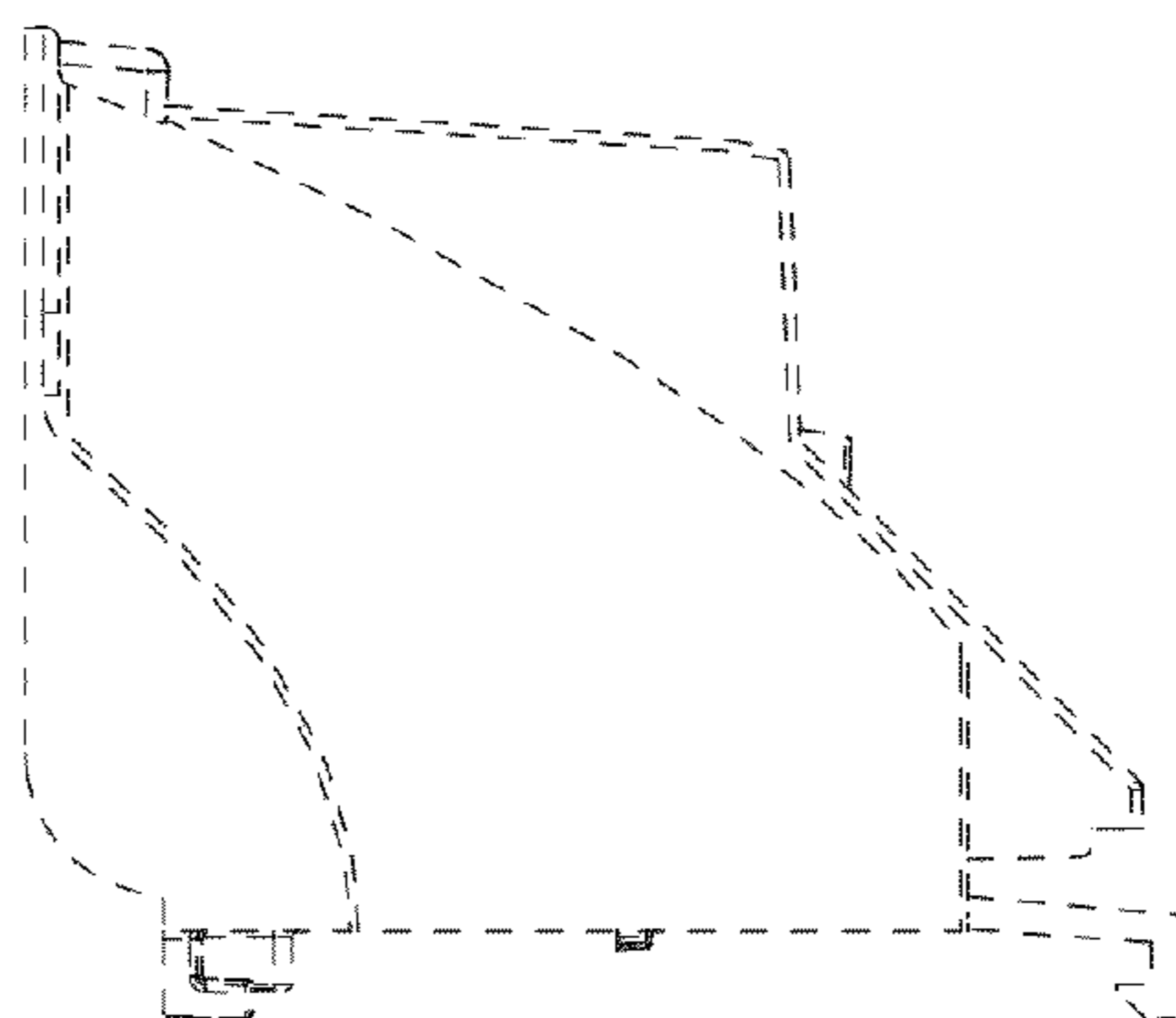

FIG. 5

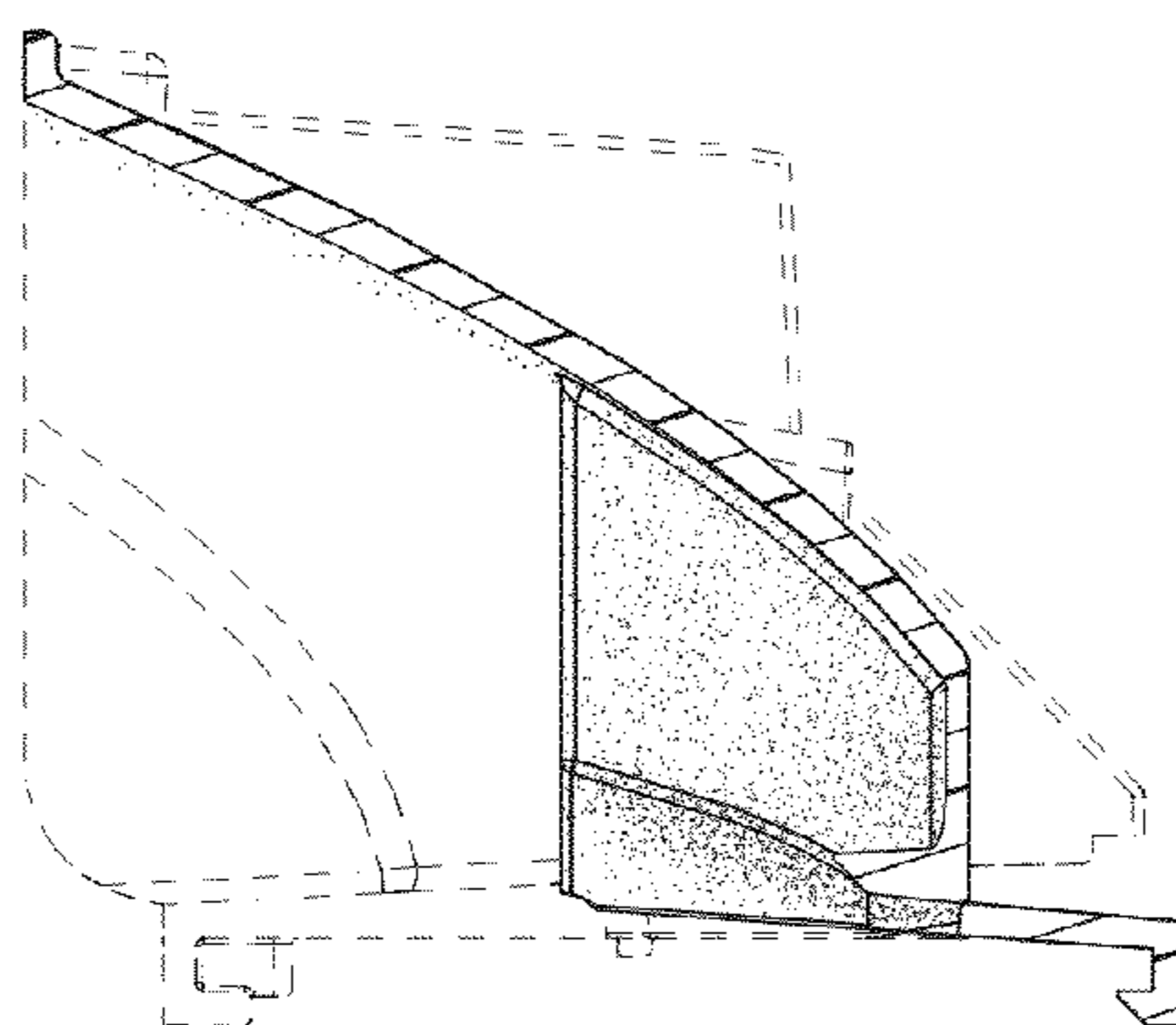

FIG. 6

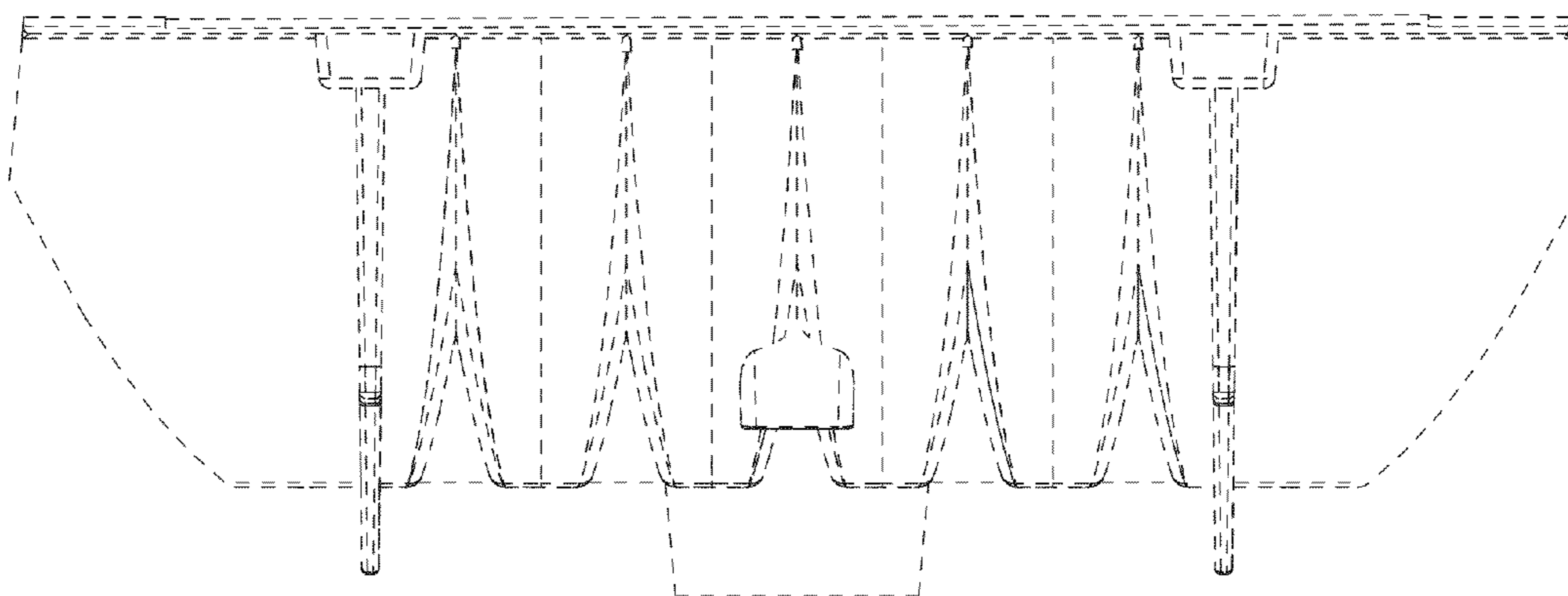

FIG. 7

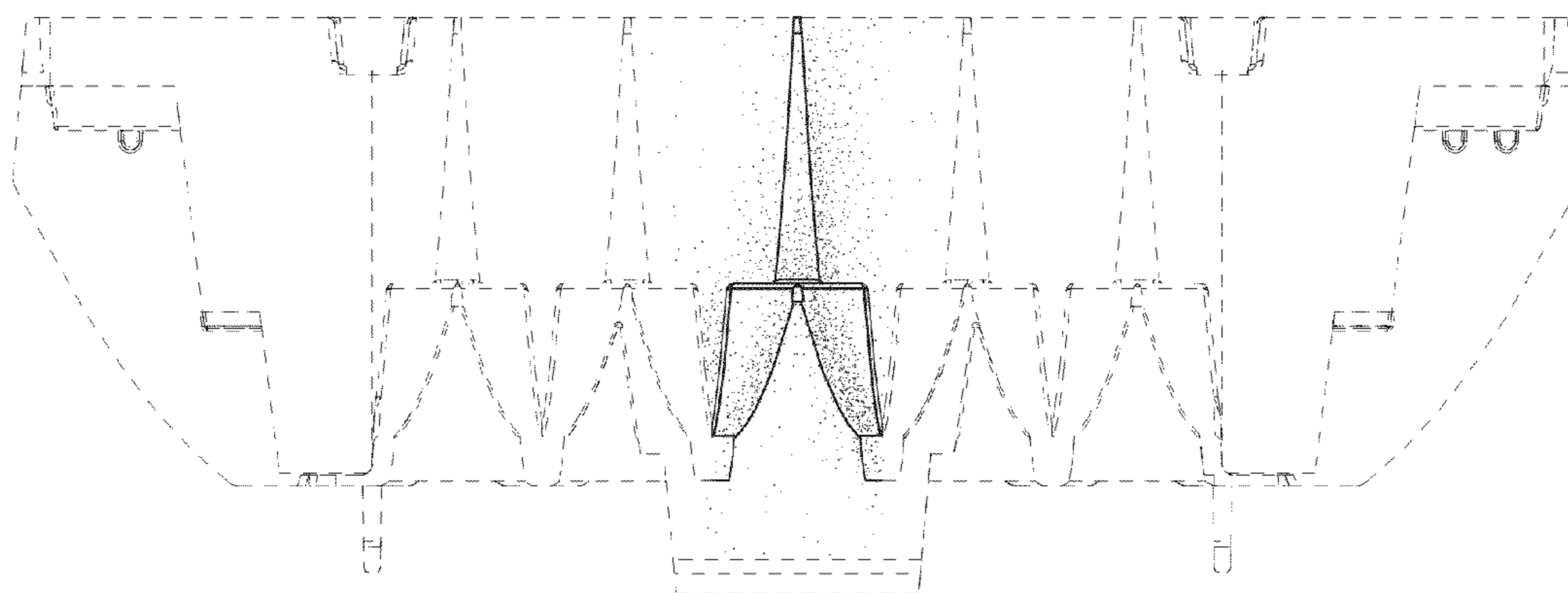

FIG. 8