



US00D707350S

(12) **United States Design Patent**
Woodard et al.

(10) **Patent No.:** **US D707,350 S**
(45) **Date of Patent:** **** Jun. 17, 2014**

- (54) **HANDHELD WATER FLOSSER**
- (71) Applicant: **Water Pik, Inc.**, Fort Collins, CO (US)
- (72) Inventors: **Brian J. Woodard**, Boulder, CO (US);
Hyunchul Kim, Chicago, IL (US);
Taiwon Choi, Glenview, IL (US)
- (73) Assignee: **Water Pik, Inc.**, Fort Collins, CO (US)

3,209,956 A 10/1965 McKenzie
 3,216,619 A 11/1965 Richards et al.
 3,225,759 A 12/1965 Drapen et al.

(Continued)

FOREIGN PATENT DOCUMENTS

CA 851479 9/1970
 CH 655237 4/1987

(Continued)

OTHER PUBLICATIONS

US RE27,274, 01/1972, Mattingly (withdrawn).

(Continued)

- (**) Term: **14 Years**
- (21) Appl. No.: **29/434,319**

(22) Filed: **Oct. 11, 2012**

(51) **LOC (10) Cl.** **24-02**

(52) **U.S. Cl.**
USPC **D24/111**

(58) **Field of Classification Search**
 USPC D24/152, 108, 111-114, 176-177;
 601/160, 162, 165; 433/80, 82, 83-84,
 433/88, 89
 See application file for complete search history.

(56) **References Cited**

U.S. PATENT DOCUMENTS

555,588 A	3/1896	Spencer
1,278,225 A	9/1918	Schamberg
1,498,267 A	6/1924	Hachman
1,650,686 A	11/1927	Binks
1,681,320 A	8/1928	Bergl et al.
1,933,454 A	10/1933	Sidney
2,107,686 A	2/1938	Bramsen et al.
2,669,233 A	2/1954	Friend
2,794,437 A	6/1954	Tash
2,783,919 A	3/1957	Ansell
2,984,452 A	5/1961	Hooper
3,089,490 A	5/1963	Goldberg
3,096,913 A	7/1963	Jousson
3,144,867 A	8/1964	Trupp et al.

Primary Examiner — Wan Laymon

(74) *Attorney, Agent, or Firm* — Dorsey & Whitney LLP

(57) **CLAIM**

We claim the ornamental design for a handheld water flosser, substantially as shown and described.

DESCRIPTION

FIG. 1 is a front, right isometric view of a handheld water flosser.

FIG. 2 is a front elevation view of the handheld water flosser of FIG. 1.

FIG. 3 is a rear elevation view of the handheld water flosser of FIG. 1.

FIG. 4 is a right side elevation view of the handheld water flosser of FIG. 1.

FIG. 5 is a left side elevation view of the handheld water flosser of FIG. 1.

FIG. 6 is a top plan view of the handheld water flosser of FIG. 1; and,

FIG. 7 is a bottom plan view of the handheld water flosser of FIG. 1.

The broken lines shown in FIGS. 3 and 7 represent portions of the handheld water flosser that form no part of the claimed design.

1 Claim, 6 Drawing Sheets

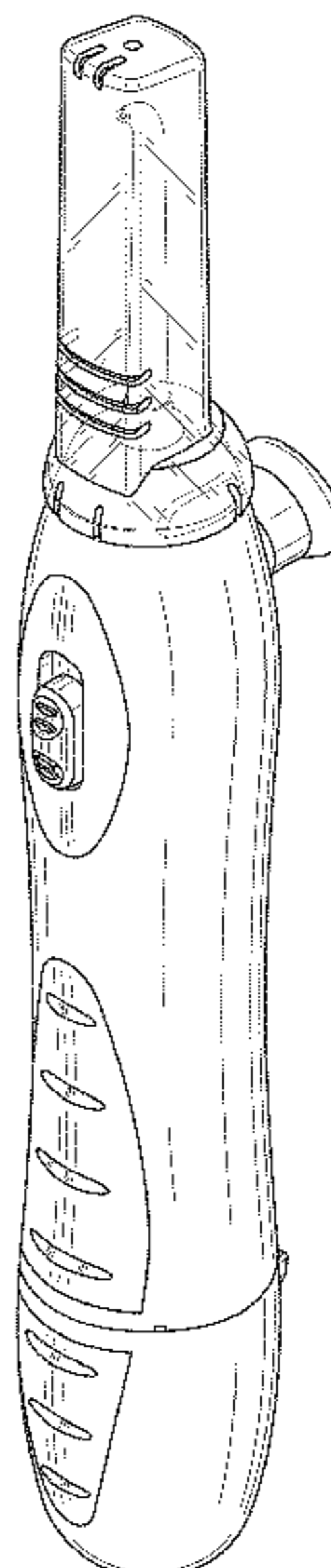

(56)

References Cited

U.S. PATENT DOCUMENTS

3,227,158 A	1/1966	Mattingly	4,276,880 A	7/1981	Malmin
3,297,558 A	1/1967	Hillquist	4,302,186 A	11/1981	Cammack et al.
D208,778 S	10/1967	Koch	4,303,064 A	12/1981	Buffa
D209,395 S	11/1967	Gilbert	4,303,070 A	12/1981	Ichikawa et al.
3,370,214 A	2/1968	Aymar	4,315,741 A	2/1982	Reichl
3,391,696 A	7/1968	Woodward	4,319,568 A	3/1982	Tregoning
3,400,999 A	9/1968	Goldstein	4,331,422 A	5/1982	Heyman
3,418,552 A	12/1968	Holmes	4,337,040 A	6/1982	Cammack et al.
3,420,228 A	1/1969	Kalbfeld	4,340,365 A	7/1982	Pisanu
3,453,969 A	7/1969	Mattingly	4,340,368 A	7/1982	Lococo
3,465,751 A	9/1969	Powers	D266,117 S	9/1982	Oberheim
3,487,828 A	1/1970	Troy	4,363,626 A	12/1982	Schmidt et al.
3,489,268 A	1/1970	Meierhoefer	4,365,376 A	12/1982	Oda et al.
3,496,933 A	2/1970	Lloyd	4,370,131 A	1/1983	Banko
3,499,440 A	3/1970	Gibbs	4,374,354 A	2/1983	Petrovic et al.
3,500,824 A *	3/1970	Gilbert 601/165	4,382,167 A	5/1983	Maruyama et al.
3,501,203 A	3/1970	Falk	4,382,786 A	5/1983	Lohn
3,502,072 A	3/1970	Stillman	D270,000 S	8/1983	Ketler
3,517,669 A	6/1970	Buono et al.	4,412,823 A	11/1983	Sakai et al.
D218,270 S	8/1970	Soper	4,442,830 A	4/1984	Markau
3,522,801 A	8/1970	Robinson	4,442,831 A	4/1984	Trenary
3,536,065 A	10/1970	Moret	4,452,238 A	6/1984	Kerr
3,537,444 A	11/1970	Garn	4,454,866 A	6/1984	Fayen
3,538,950 A	11/1970	Porteners	4,512,769 A	4/1985	Kozam et al.
3,547,110 A	12/1970	Balamuth	4,517,962 A	5/1985	Heckele
3,561,433 A *	2/1971	Kovach 601/162	4,531,912 A	7/1985	Schuss et al.
3,572,375 A	3/1971	Rosenberg	4,531,913 A	7/1985	Taguchi
3,578,884 A	5/1971	Jacobson	4,534,340 A	8/1985	Kerr et al.
3,583,609 A	6/1971	Oppenheimer	4,552,130 A	11/1985	Kinoshita
3,590,813 A	7/1971	Roszyk	D283,374 S	4/1986	Cheuk-Yiu
3,608,548 A	9/1971	Lewis	4,585,415 A	4/1986	Hommann
3,636,947 A	1/1972	Balamuth	4,591,777 A	5/1986	McCarty et al.
3,651,576 A	3/1972	Massa	4,592,728 A	6/1986	Davis
3,669,101 A	6/1972	Kleiner	4,602,906 A	7/1986	Grunenfelder
3,703,170 A	11/1972	Ryckman, Jr.	4,607,627 A	8/1986	Leber et al.
3,747,595 A	7/1973	Grossan	4,613,074 A	9/1986	Schulze
3,768,472 A	10/1973	Hodosh et al.	4,619,612 A	10/1986	Weber et al.
3,783,364 A	1/1974	Gallanis et al.	4,629,425 A	12/1986	Detsch
3,809,977 A	5/1974	Balamuth et al.	4,636,198 A	1/1987	Stade
3,820,532 A	6/1974	Eberhardt et al.	4,644,937 A	2/1987	Hommann
3,827,147 A	8/1974	Condon	4,645,488 A	2/1987	Matukas
3,840,795 A	10/1974	Roszyk et al.	4,647,831 A	3/1987	O'Malley et al.
3,854,209 A	12/1974	Franklin et al.	4,648,838 A	3/1987	Schlachter
3,874,506 A	4/1975	Hill et al.	4,650,475 A	3/1987	Smith et al.
3,912,125 A	10/1975	Acklin	4,655,198 A	4/1987	Hommann
3,943,628 A	3/1976	Kronman et al.	4,669,453 A	6/1987	Atkinson et al.
3,973,558 A	8/1976	Stouffer et al.	4,672,953 A	6/1987	DiVito
4,001,526 A	1/1977	Olson	4,673,396 A	6/1987	Urbaniak
4,004,302 A	1/1977	Hori	D291,354 S	8/1987	Camens
4,007,739 A	2/1977	Bron et al.	4,716,352 A	12/1987	Hurn et al.
D246,667 S	12/1977	Mackay et al.	4,770,632 A	9/1988	Ryder et al.
4,060,870 A	12/1977	Cannarella	4,783,321 A	11/1988	Spence
4,075,761 A	2/1978	Behne et al.	4,787,845 A	11/1988	Valentine
4,078,558 A	3/1978	Woog et al.	4,787,847 A	11/1988	Martin et al.
4,108,167 A	8/1978	Hickman et al.	4,798,292 A	1/1989	Hauze
4,108,178 A	8/1978	Betush	4,803,974 A	2/1989	Powell
4,109,650 A	8/1978	Peclard	4,804,364 A	2/1989	Dieras et al.
4,135,501 A *	1/1979	Leunissan 433/80	4,818,229 A	4/1989	Vasile
4,141,352 A	2/1979	Ebner et al.	4,820,152 A	4/1989	Warrin et al.
4,144,646 A	3/1979	Takemoto et al.	4,821,923 A	4/1989	Skorka
4,149,315 A	4/1979	Page, Jr. et al.	4,824,368 A	4/1989	Hickman
4,154,375 A	5/1979	Bippus	4,826,431 A	5/1989	Fujimura et al.
4,160,383 A	7/1979	Rauschenberger	4,832,683 A	5/1989	Idemoto et al.
4,182,038 A	1/1980	Fleer	4,854,869 A	8/1989	Lawhorn
4,201,200 A	5/1980	Hubner	4,861,340 A	8/1989	Smith et al.
4,215,476 A	8/1980	Armstrong	4,862,876 A	9/1989	Lih-Sheng
4,219,618 A	8/1980	Leonard	4,869,720 A	9/1989	Chernack
4,227,878 A	10/1980	Lohn	4,880,382 A	11/1989	Moret et al.
4,229,634 A	10/1980	Hickman et al.	4,886,452 A	12/1989	Lohn
4,236,889 A	12/1980	Wright	4,900,252 A	2/1990	Liefke et al.
4,248,589 A	2/1981	Lewis	4,902,225 A	2/1990	Lohn
4,249,899 A	2/1981	Davis	4,903,687 A	2/1990	Lih-Sheng
4,262,799 A	4/1981	Perrett	4,906,187 A	3/1990	Amadera
4,266,934 A	5/1981	Pernot	4,907,744 A	3/1990	Jousson
4,276,023 A	6/1981	Phillips et al.	4,925,450 A	5/1990	Imonti et al.
			4,928,675 A	5/1990	Thornton
			4,930,660 A	6/1990	Porteous
			4,941,459 A	7/1990	Mathur
			4,950,159 A	8/1990	Hansen

(56)

References Cited

U.S. PATENT DOCUMENTS

4,958,629	A	9/1990	Peace et al.	5,380,201	A	1/1995	Kawata
4,958,751	A	9/1990	Curtis et al.	D356,864	S	3/1995	Woog
4,961,698	A	10/1990	Vlock	5,399,089	A	3/1995	Eichman et al.
4,966,551	A	10/1990	Betush	D358,883	S	5/1995	Vos
4,969,874	A	11/1990	Michel et al.	5,456,672	A	10/1995	Diederich et al.
4,973,247	A	11/1990	Varnes et al.	5,465,445	A	11/1995	Yeh
4,973,250	A	11/1990	Milman	5,468,148	A	11/1995	Ricks
4,975,054	A	12/1990	Esrock	5,470,305	A	11/1995	Arnett et al.
4,979,503	A	12/1990	Chernack	5,474,450	A	12/1995	Chronister
4,979,504	A	12/1990	Mills	5,474,451	A	12/1995	Dalrymple et al.
4,989,590	A	2/1991	Baum et al.	5,476,379	A	12/1995	Disel
4,998,880	A	3/1991	Nerli	5,484,281	A	1/1996	Renow et al.
5,013,241	A	5/1991	Von Gutfeld et al.	5,487,877	A	1/1996	Choi
5,014,884	A	5/1991	Wunsch	5,490,779	A	2/1996	Malmin
5,019,054	A	5/1991	Clement et al.	5,505,916	A	4/1996	Berry, Jr.
5,027,798	A	7/1991	Primiano	D369,656	S	5/1996	Vos
5,029,576	A	7/1991	Evans, Sr.	5,525,058	A	6/1996	Gallant et al.
5,033,961	A	7/1991	Kankler et al.	5,526,841	A	6/1996	Detsch et al.
D318,918	S	8/1991	Hartwein	5,540,587	A	7/1996	Malmin
5,046,486	A	9/1991	Grulke et al.	5,547,374	A	8/1996	Coleman
5,049,071	A	9/1991	Davis et al.	D373,631	S	9/1996	Maeda et al.
5,060,825	A	10/1991	Palmer et al.	5,554,025	A	9/1996	Kinsel
5,062,795	A	* 11/1991	Woog 433/80	5,556,001	A	9/1996	Weissman et al.
5,064,168	A	11/1991	Raines et al.	5,564,629	A	10/1996	Weissman et al.
D322,314	S	* 12/1991	Ohbayashi D24/113	5,564,629	A	10/1996	Weissman et al.
5,082,443	A	1/1992	Lohn	5,616,028	A	4/1997	Hafele et al.
5,086,756	A	2/1992	Powell	5,634,791	A	6/1997	Matsuura et al.
5,095,893	A	3/1992	Rawden, Jr.	5,636,987	A	6/1997	Serfaty
5,098,291	A	3/1992	Curtis et al.	5,640,735	A	6/1997	Manning
5,125,835	A	6/1992	Young	5,653,591	A	8/1997	Loge
5,127,831	A	7/1992	Bab	5,667,483	A	9/1997	Santos
5,142,723	A	9/1992	Lustig et al.	5,683,192	A	11/1997	Kilfoil
5,150,841	A	9/1992	Silvenis et al.	5,685,829	A	11/1997	Allen
5,172,810	A	12/1992	Brewer	5,685,851	A	11/1997	Murphy et al.
5,173,273	A	12/1992	Brewer	5,697,784	A	12/1997	Hafele et al.
5,183,035	A	2/1993	Weir	5,709,545	A	1/1998	Johnston et al.
5,197,458	A	3/1993	Ito et al.	5,716,007	A	2/1998	Nottingham et al.
5,197,460	A	3/1993	Ito et al.	5,718,668	A	2/1998	Arnett et al.
5,199,871	A	4/1993	Young	5,746,595	A	5/1998	Ford
5,203,697	A	4/1993	Malmin	5,749,726	A	5/1998	Kinsel
5,203,769	A	4/1993	Clement et al.	5,759,502	A	6/1998	Spencer et al.
5,204,004	A	4/1993	Johnston et al.	5,779,654	A	7/1998	Foley et al.
5,208,933	A	5/1993	Lustig et al.	5,795,153	A	8/1998	Rechmann
5,218,956	A	6/1993	Handler et al.	5,836,030	A	11/1998	Hazeu et al.
5,220,914	A	6/1993	Thompson	5,851,079	A	12/1998	Horstman et al.
5,228,646	A	7/1993	Raines	D403,511	S	1/1999	Serbinski
5,230,624	A	7/1993	Wolf et al.	D406,334	S	3/1999	Rosenthal et al.
5,232,687	A	8/1993	Geimer	5,876,201	A	3/1999	Wilson et al.
5,235,968	A	8/1993	Woog	5,901,397	A	5/1999	Häfele et al.
5,241,714	A	9/1993	Barry	5,934,902	A	8/1999	Abahusayn
5,246,367	A	9/1993	Ito et al.	D413,975	S	9/1999	Maeda
5,252,064	A	10/1993	Baum et al.	D417,082	S	11/1999	Classen et al.
5,257,933	A	11/1993	Jousson	5,993,402	A	11/1999	Sauer et al.
D341,943	S	12/1993	Si-Hoe	6,030,215	A	2/2000	Ellion et al.
5,267,586	A	12/1993	Jankavaara	6,039,180	A	3/2000	Grant
5,269,684	A	12/1993	Fischer	D425,615	S	5/2000	Bachman et al.
5,281,137	A	1/1994	Jousson	D425,981	S	5/2000	Bachman et al.
5,281,139	A	1/1994	Frank et al.	6,056,710	A	5/2000	Bachman et al.
5,282,745	A	2/1994	Wiltrout et al.	D426,633	S	6/2000	Bachman et al.
5,286,192	A	2/1994	Dixon	6,089,865	A	7/2000	Edgar
5,286,201	A	2/1994	Yu	6,124,699	A	9/2000	Suzuki et al.
5,297,962	A	3/1994	O'Connor et al.	D434,500	S	11/2000	Pollock et al.
D346,212	S	4/1994	Hosl	6,159,006	A	12/2000	Cook et al.
5,302,123	A	4/1994	Bechard	6,164,967	A	12/2000	Sale et al.
5,317,691	A	5/1994	Traeger	D435,905	S	1/2001	Bachman et al.
5,321,865	A	6/1994	Kaeser	6,193,512	B1	2/2001	Wallace
5,331,704	A	7/1994	Rosen et al.	6,193,932	B1	2/2001	Wu et al.
5,344,317	A	9/1994	Pacher et al.	6,199,239	B1	3/2001	Dickerson
5,346,677	A	9/1994	Risk	D439,781	S	4/2001	Spore
D351,892	S	10/1994	Wolf et al.	6,217,835	B1	4/2001	Riley et al.
5,360,338	A	11/1994	Waggoner	D441,861	S	5/2001	Haffliger
5,368,548	A	11/1994	Jousson	6,233,773	B1	5/2001	Karge et al.
5,370,534	A	12/1994	Wolf et al.	6,234,205	B1	5/2001	D'Amelio et al.
D354,168	S	1/1995	Hartwein	6,237,178	B1	5/2001	Krammer et al.
5,378,149	A	1/1995	Stropko	6,247,929	B1	6/2001	Bachman et al.
				6,293,792	B1	9/2001	Hanson
				D449,884	S	10/2001	Tobin et al.
				6,363,565	B1	4/2002	Paffrath
				6,468,482	B1	10/2002	Frieze et al.
				6,475,173	B1	11/2002	Bachman et al.

(56)

References Cited

U.S. PATENT DOCUMENTS

6,485,451 B1 11/2002 Roberts et al.
 6,497,572 B2 12/2002 Hood et al.
 6,502,584 B1 1/2003 Fordham
 D470,660 S 2/2003 Schaber
 6,558,344 B2 5/2003 McKinnon et al.
 6,561,808 B2 5/2003 Neuberger et al.
 D475,346 S 6/2003 McCurrach et al.
 6,589,477 B1 7/2003 Frieze et al.
 6,602,071 B1 8/2003 Ellion et al.
 6,632,091 B1 10/2003 Cise et al.
 D482,451 S 11/2003 Page et al.
 6,640,999 B2 11/2003 Peterson
 6,647,577 B2 11/2003 Tam
 6,659,674 B2 12/2003 Carlucci et al.
 6,669,059 B2 12/2003 Mehta
 D486,573 S 2/2004 Callaghan et al.
 6,689,078 B1 2/2004 Rehkemper et al.
 6,699,208 B2 3/2004 Bachman et al.
 6,719,561 B2 4/2004 Gugel et al.
 D489,183 S 5/2004 Akahori et al.
 6,739,782 B1 5/2004 Rehkemper et al.
 6,740,053 B2 5/2004 Kaplowitz
 D490,899 S 6/2004 Gagnon
 D491,728 S 6/2004 Jimenez
 D492,996 S 7/2004 Rehkemper et al.
 6,761,324 B2 7/2004 Chang
 6,766,549 B2 7/2004 Klupt
 D495,142 S 8/2004 Berde
 D495,143 S 8/2004 Berde
 6,779,216 B2 8/2004 Davies et al.
 6,783,004 B1 8/2004 Rinner
 6,783,505 B1 8/2004 Lai
 6,796,796 B2 9/2004 Segal
 6,814,259 B1 11/2004 Foster et al.
 D499,885 S 12/2004 Xi
 6,835,181 B2 12/2004 Hippensteel
 6,837,708 B2 * 1/2005 Chen et al. 433/80
 6,884,069 B2 4/2005 Goldman
 6,907,879 B2 6/2005 Drinan et al.
 D509,585 S 9/2005 Kling et al.
 D513,638 S 1/2006 Pan
 7,080,980 B2 7/2006 Klupt
 D530,010 S 10/2006 Luetgen et al.
 7,117,555 B2 10/2006 Fattori et al.
 D533,720 S 12/2006 Vu
 7,147,468 B2 12/2006 Snyder et al.
 D538,474 S 3/2007 Sheppard et al.
 D548,334 S 8/2007 Izumi
 D550,097 S 9/2007 Lepoitevin
 7,276,035 B2 10/2007 Lu
 7,314,456 B2 1/2008 Shaw
 D565,175 S 3/2008 Boyd et al.
 7,344,510 B1 3/2008 Yande
 7,367,803 B2 5/2008 Egeresi
 7,455,521 B2 11/2008 Fishburne, Jr.
 7,469,440 B2 12/2008 Boland et al.
 7,500,584 B2 3/2009 Schutz
 D601,697 S 10/2009 Sobeich et al.
 D603,708 S 11/2009 Handy
 7,670,141 B2 3/2010 Thomas et al.
 7,677,888 B1 3/2010 Halm
 7,814,585 B1 10/2010 Reich
 D629,884 S 12/2010 Stephens
 7,862,536 B2 1/2011 Chen et al.
 7,878,403 B2 2/2011 Hennick et al.
 7,959,597 B2 6/2011 Baker et al.
 8,113,832 B2 2/2012 Snyder et al.
 D670,373 S 11/2012 Taylor et al.
 8,403,665 B2 * 3/2013 Thomas et al. 433/80
 2003/0098249 A1 5/2003 Rollock
 2003/0204155 A1 10/2003 Egeresi
 2003/0213075 A1 11/2003 Hui et al.
 2004/0045107 A1 3/2004 Egeresi
 2004/0076921 A1 4/2004 Gofman et al.
 2004/0122377 A1 6/2004 Fischer et al.

2004/0209222 A1 10/2004 Snyder et al.
 2005/0049620 A1 3/2005 Chang
 2005/0101894 A1 5/2005 Hippensteel
 2005/0271531 A1 12/2005 Brown et al.
 2006/0008373 A1 1/2006 Schutz
 2006/0021165 A1 2/2006 Boland et al.
 2006/0026784 A1 2/2006 Moskovich et al.
 2006/0057539 A1 3/2006 Sodo
 2006/0078844 A1 4/2006 Goldman et al.
 2006/0079818 A1 4/2006 Yande
 2007/0082316 A1 4/2007 Zhadanov et al.
 2007/0113360 A1 5/2007 Tsai
 2007/0202459 A1 8/2007 Boyd et al.
 2007/0203439 A1 8/2007 Boyd et al.
 2007/0254260 A1 11/2007 Alden
 2008/0008979 A1 1/2008 Thomas et al.
 2009/0070949 A1 3/2009 Sagel et al.
 2009/0082706 A1 3/2009 Shaw
 2009/0124945 A1 5/2009 Reich et al.
 2009/0163839 A1 6/2009 Alexander
 2009/0281454 A1 11/2009 Baker et al.
 2010/0015566 A1 1/2010 Shaw
 2010/0190132 A1 7/2010 Taylor et al.
 2010/0209870 A1 8/2010 Thomas et al.
 2010/0239998 A1 9/2010 Snyder et al.
 2010/0261134 A1 10/2010 Boyd et al.
 2010/0261137 A1 10/2010 Boyd et al.
 2010/0266980 A1 10/2010 Boyd et al.
 2010/0326536 A1 12/2010 Nan
 2010/0330527 A1 12/2010 Boyd et al.
 2011/0027749 A1 2/2011 Syed
 2011/0097683 A1 4/2011 Boyd et al.
 2011/0139826 A1 6/2011 Hair et al.
 2011/0144588 A1 6/2011 Taylor et al.
 2011/0184341 A1 7/2011 Baker et al.
 2012/0021374 A1 1/2012 Cacka et al.
 2012/0045730 A1 2/2012 Snyder et al.
 2012/0077145 A1 3/2012 Tsurukawa
 2012/0141952 A1 6/2012 Snyder et al.
 2012/0277677 A1 11/2012 Taylor et al.
 2012/0277678 A1 11/2012 Taylor et al.
 2012/0295220 A1 11/2012 Thomas et al.

FOREIGN PATENT DOCUMENTS

DE 1466963 5/1969
 DE 2409752 9/1975
 DE 2545936 4/1977
 DE 2910982 2/1980
 EP 0023672 7/1980
 FR 2556954 6/1985
 FR 2654627 5/1991
 GB 1182031 2/1970
 GB 2018605 10/1979
 JP 2-134150 4/1990
 JP 2009-39455 2/2009
 WO WO95/16404 6/1995
 WO WO2004/021958 3/2004
 WO WO2004/039205 5/2004

OTHER PUBLICATIONS

The Right Tool, Electron Fusion Devices, Inc., 2 pages, at least as early as Feb. 1991.
 Japanese Packaging, 2 pages, at least as early as Dec. 2002.
 Japanese Instruction Brochure, 20 pages, at least as early as Dec. 2002.
 Brochure: Woog International, "You have a 98% chance of getting gum disease. Unless you read this.", Lancaster, Pennsylvania, 5 pages, Feb. 1987.
 Brochure: Woog International, "We put the control of home dental care back into the hands of the professional", Lancaster, Pennsylvania, 2 pages, Feb. 1987.
 Brochure: Woog International, "Products at a Glance: Home Dental Care System" Woog Orajet, 3 pages, at least as early as Dec. 18, 1998.
 Website: http://www.just4teeth.com/product/Panasonic/Panasonic_Portable_Irrigator.htm, 2 pages, at least as early as Jun. 20, 2003.

(56)

References Cited

OTHER PUBLICATIONS

Website: http://www.videodirectstore.com/store/merchant.mv?Screen=PROD&Product_Code=EW1. . . , 2 pages, at least as early as Jun. 20, 2003.

Website: <http://www.products.consumerguide.com/cp/family/review/index.dfm/id/18742>, 2 pages, at least as early as Jun. 20, 2003.

Website: <http://www.racekarteng.com/images/walbroparts.gif> and <http://www.muller.net/mullermachine/docs/walbro1.html>, 4 pages, at least as early as Jun. 20, 2003.

Waterpik SinuSense Website: <http://www.insightsbyapril.com/2012/03/waterpik-natural-remedy-for-sinus.html>, 8 pages, retrieved on May 31, 2012.

* cited by examiner

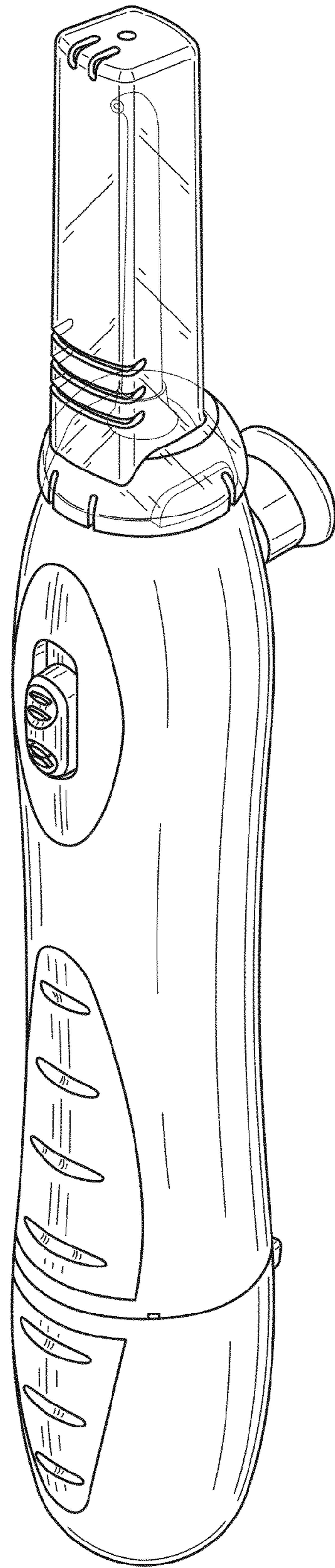

FIG.1

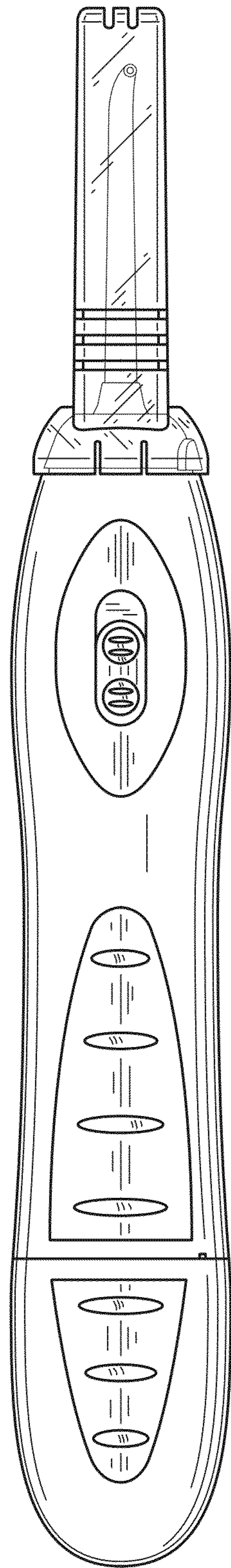

FIG.2

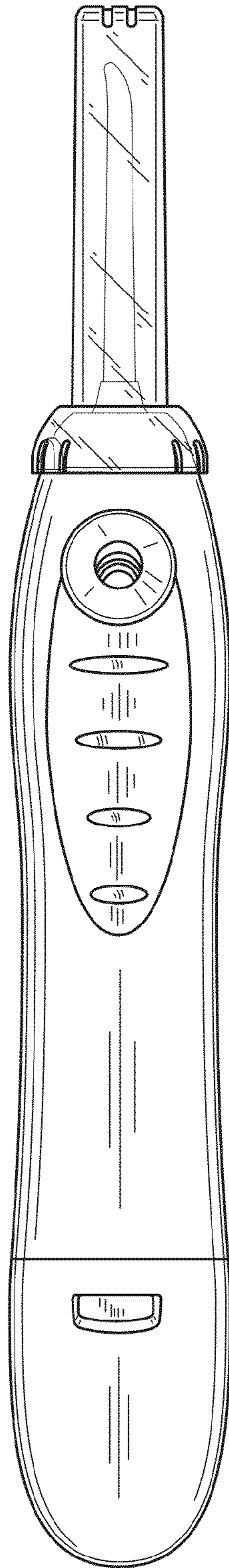

FIG.3

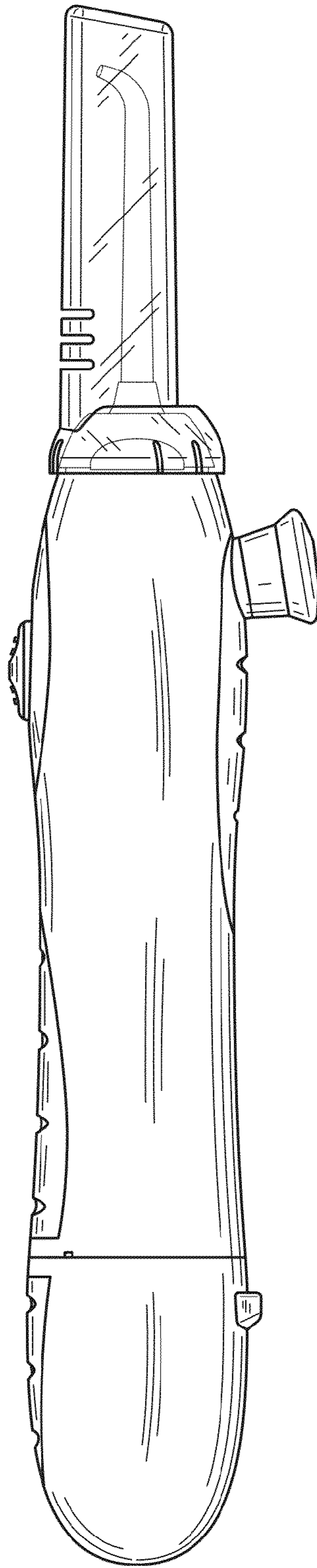

FIG.4



FIG.5

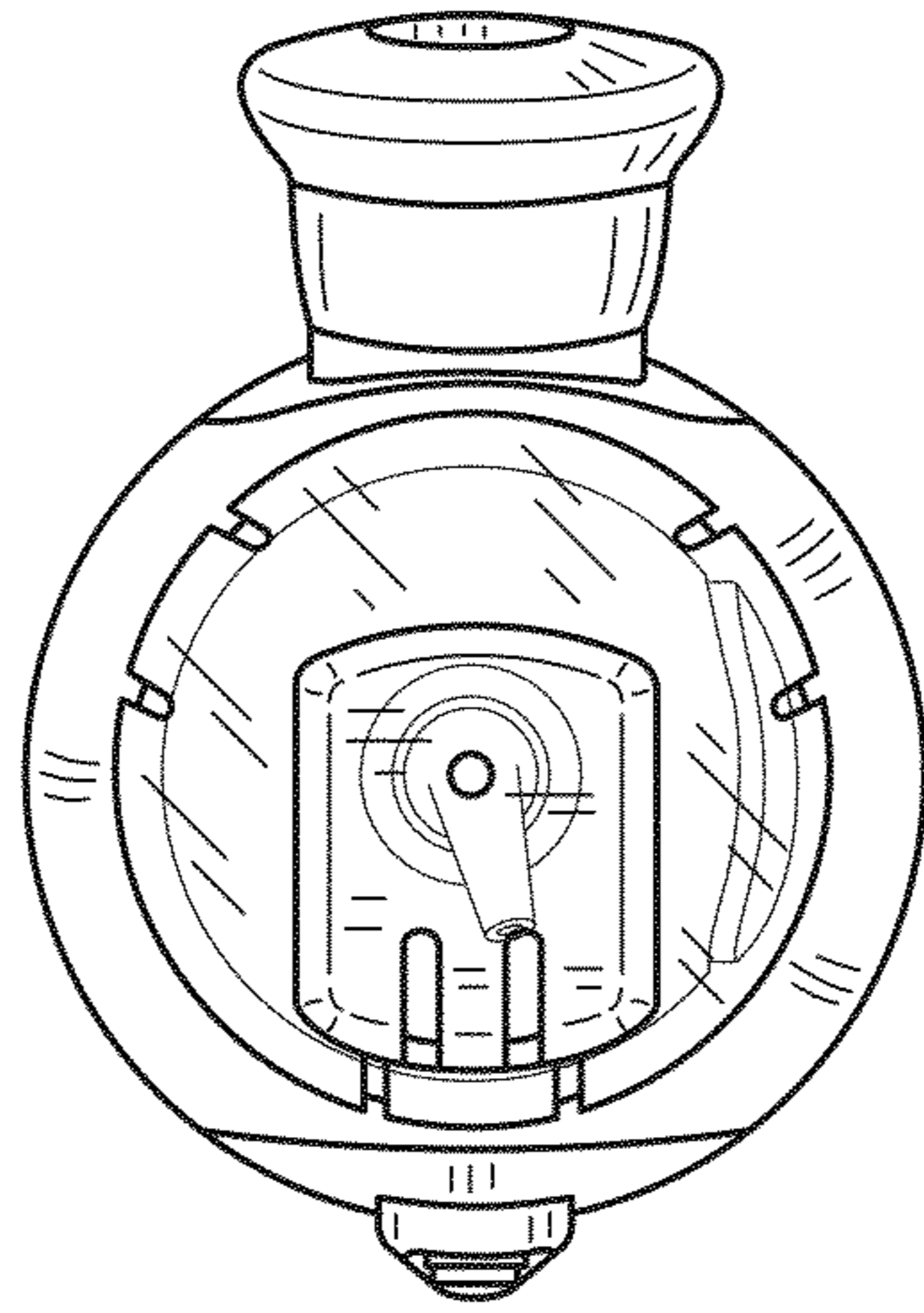

FIG. 6

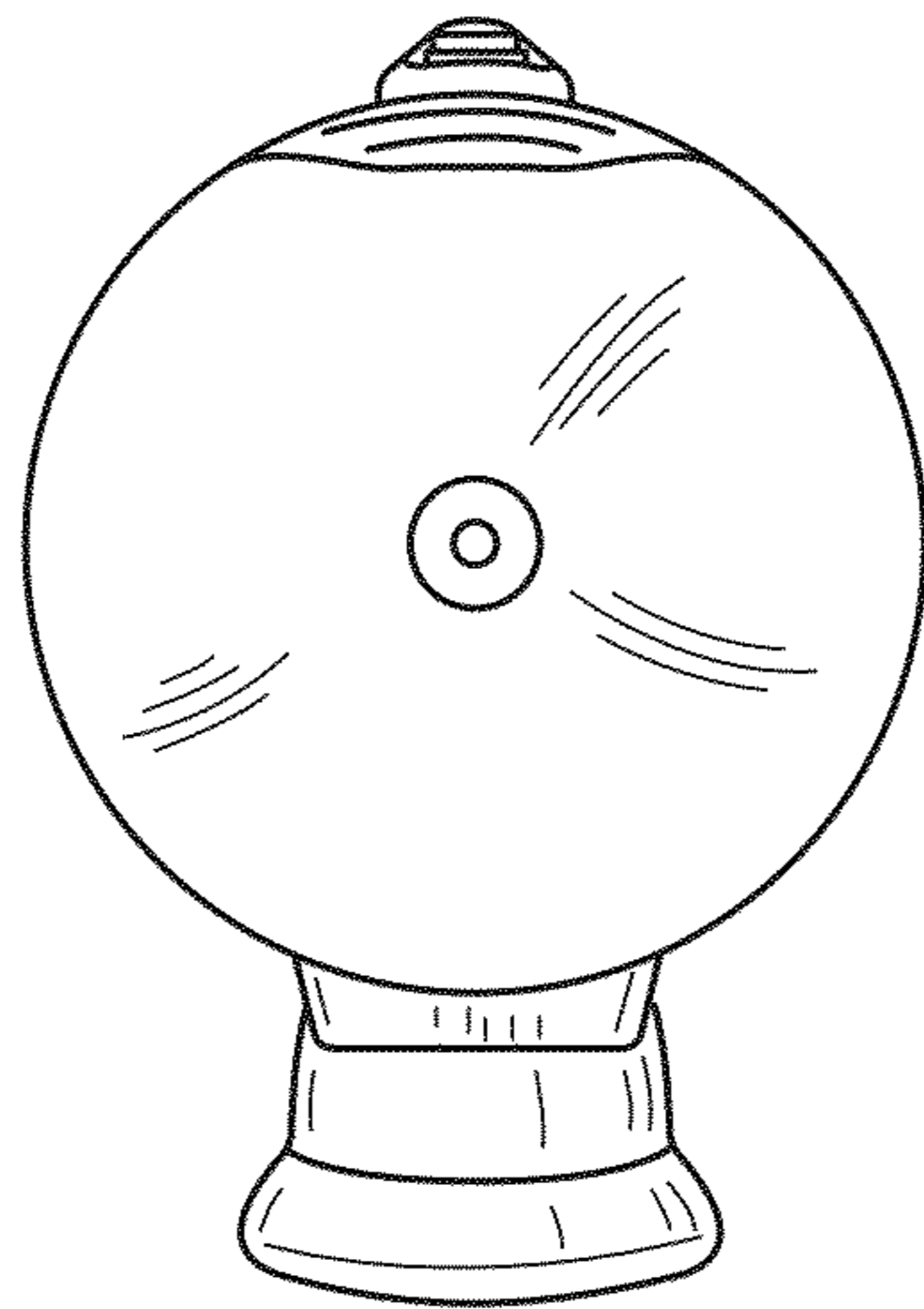

FIG. 7