



US00D707325S

(12) **United States Design Patent**
Li

(10) **Patent No.:** **US D707,325 S**
(45) **Date of Patent:** **** Jun. 17, 2014**

(54) **FLUTTERING FISHING SPOON DESIGN**

(71) Applicant: **Hai Yang Li**, Harbin (CN)

(72) Inventor: **Hai Yang Li**, Harbin (CN)

(**) Term: **14 Years**

(21) Appl. No.: **29/462,916**

(22) Filed: **Aug. 9, 2013**

(51) **LOC (10) Cl.** **22-05**

(52) **U.S. Cl.**
USPC **D22/129**

(58) **Field of Classification Search**
USPC D22/126–133; 43/42.5, 42.51, 42.52,
43/42.53, 42.03, 42.18
See application file for complete search history.

(56) **References Cited**

U.S. PATENT DOCUMENTS

| | | | | |
|--------------|---------|------------|-------|---------|
| D328,633 S * | 8/1992 | Terrill | | D22/129 |
| D374,907 S * | 10/1996 | Ketchum | | D22/129 |
| D447,211 S * | 8/2001 | Kysilka | | D22/129 |
| D449,365 S * | 10/2001 | Bambacigno | | D22/129 |
| D635,636 S * | 4/2011 | Bekkala | | D22/129 |
| D698,001 S * | 1/2014 | Fors | | D22/129 |

* cited by examiner

Primary Examiner — Catheri Oliver-Garcia

(74) *Attorney, Agent, or Firm* — Richard T. Ogawa; Ogawa P.C.

(57) **CLAIM**

The ornamental design for the fluttering fishing spoon design, as shown and described.

DESCRIPTION

FIG. 1 is a perspective view of a fishing lure showing an embodiment of my new design;
FIG. 2 is a top view of the fishing lure shown in FIG. 1;
FIG. 3 is a bottom view of the fishing lure shown in FIG. 1;
FIG. 4 is a left side view of the fishing lure shown in FIG. 1;
FIG. 5 is a right side view of the fishing lure shown in FIG. 1;
FIG. 6 is a front view of the fishing lure shown in FIG. 1;
FIG. 7 is a rear view of the fishing lure shown in FIG. 1;
FIG. 8 is a perspective view of a fishing lure showing another embodiment of my new design;
FIG. 9 is a top view of the fishing lure shown in FIG. 8;
FIG. 10 is a bottom view of the fishing lure shown in FIG. 8;
FIG. 11 is a left side view of the fishing lure shown in FIG. 8;
FIG. 12 is a right side view of the fishing lure shown in FIG. 8;
FIG. 13 is a front view of the fishing lure shown in FIG. 8; and,
FIG. 14 is a rear view of the fishing lure shown in FIG. 8.
The broken lines are for environmental purposes only and do not form a part of the claimed design.

1 Claim, 14 Drawing Sheets

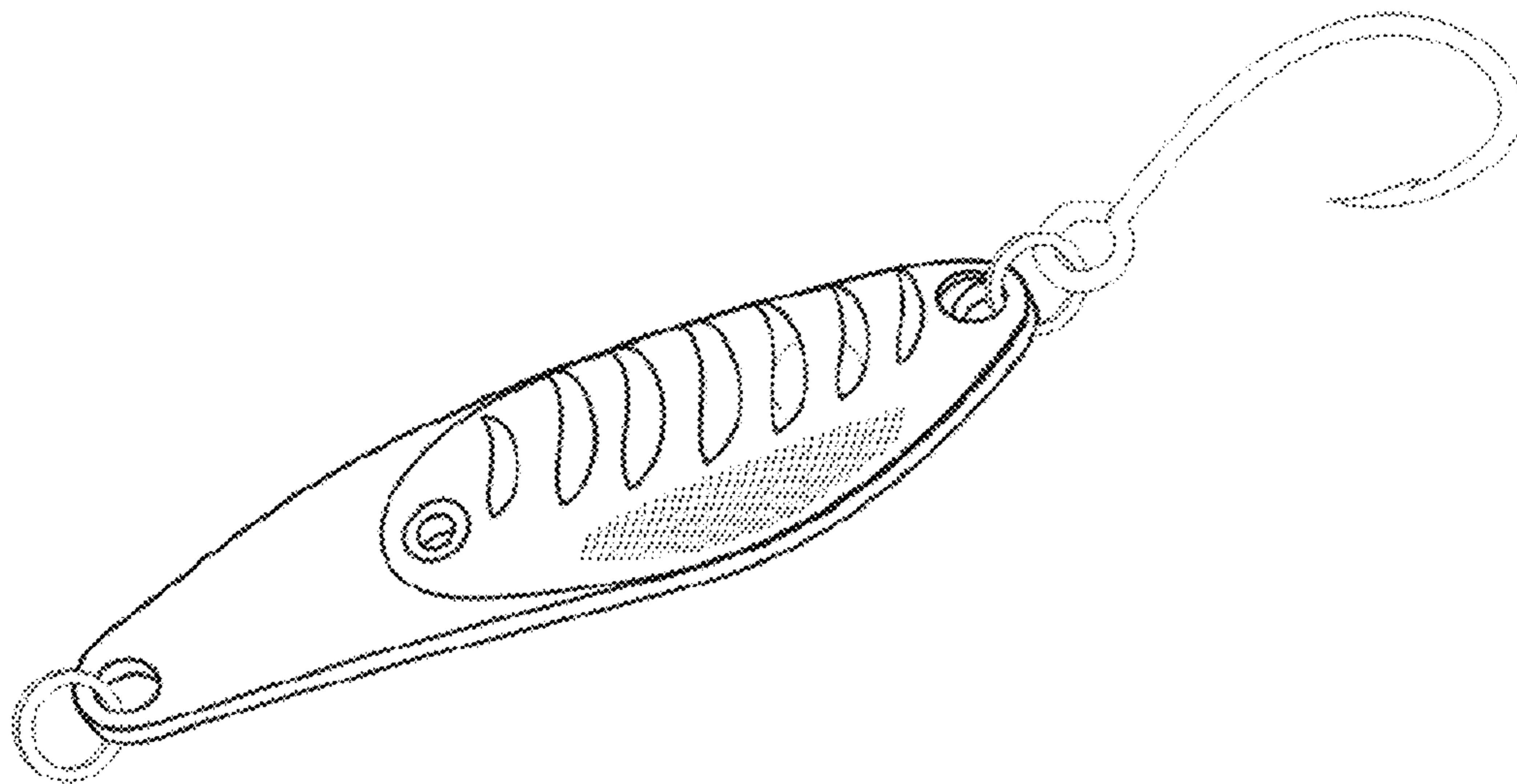

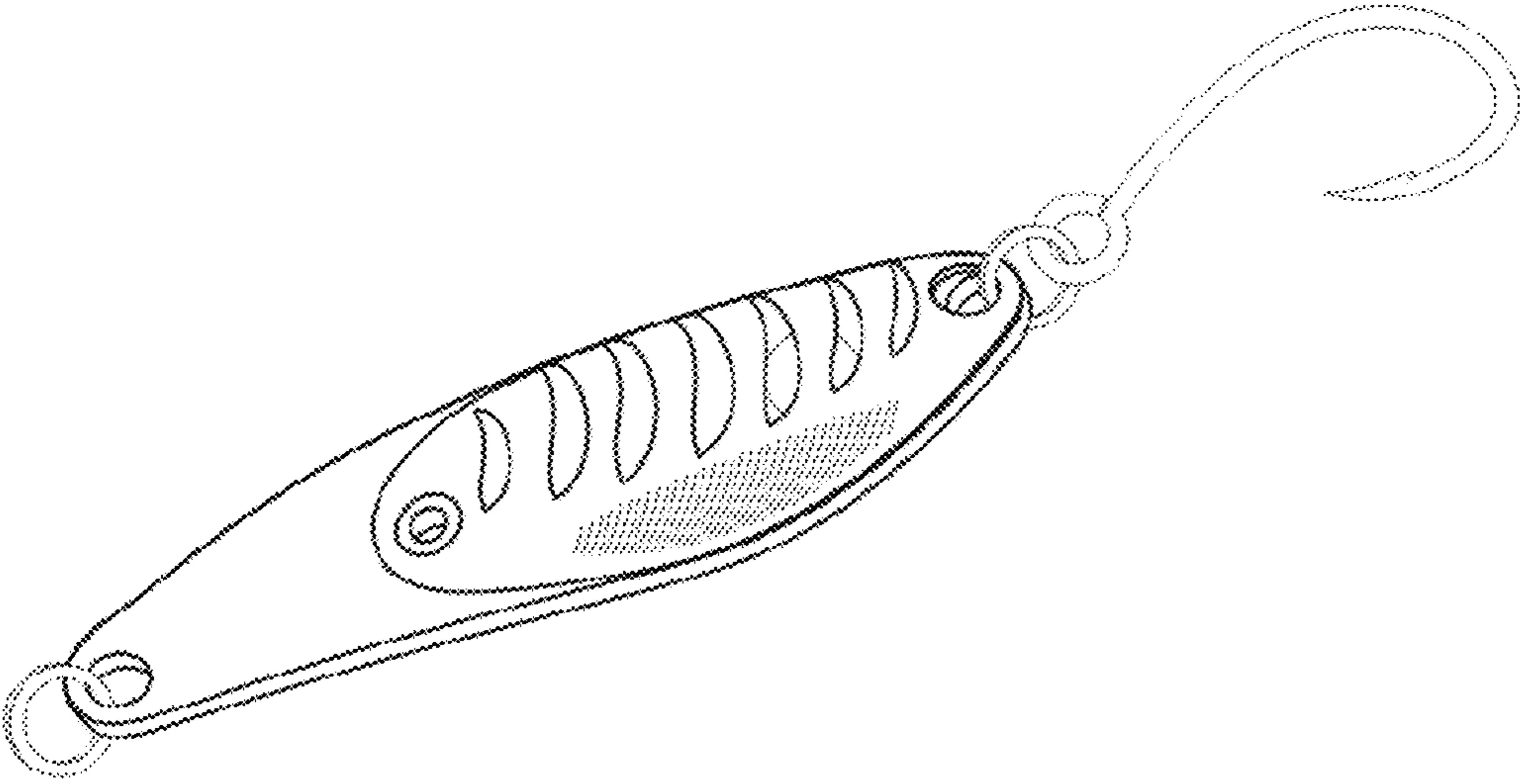

FIG. 1

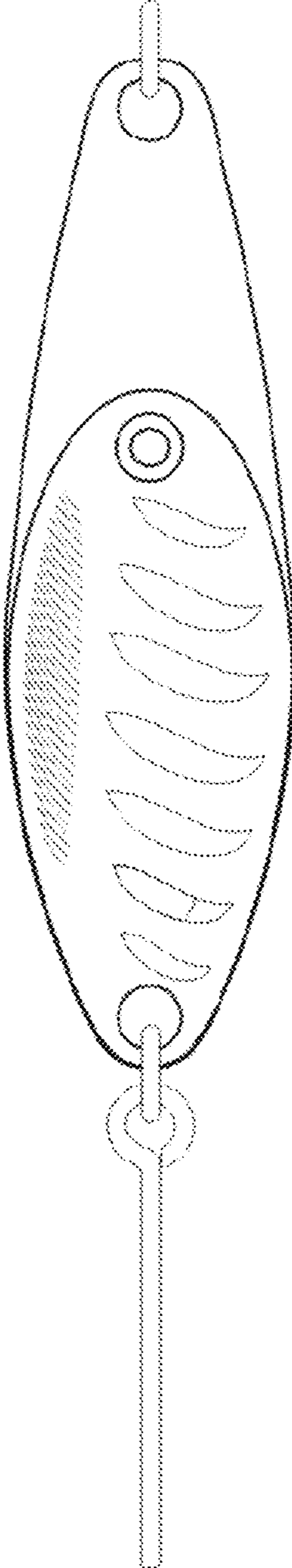

FIG. 2

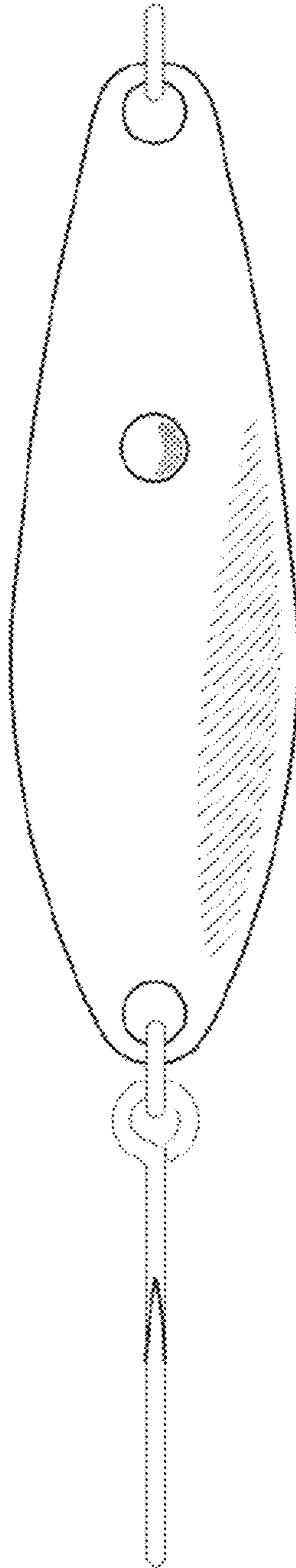

FIG. 3

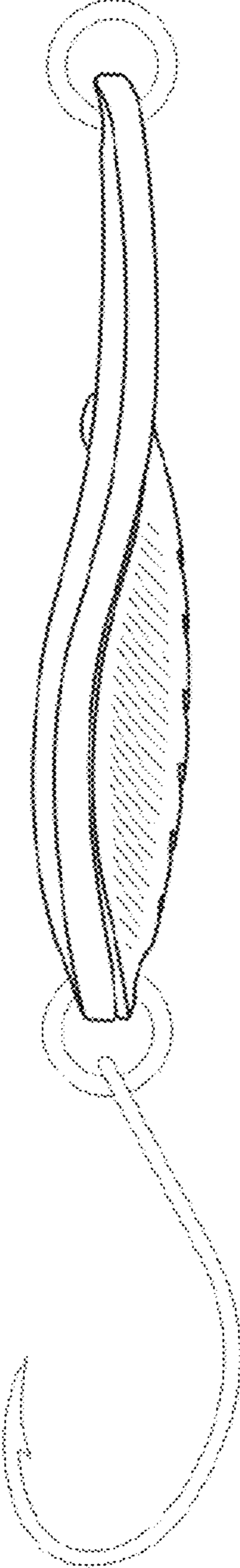

FIG. 4

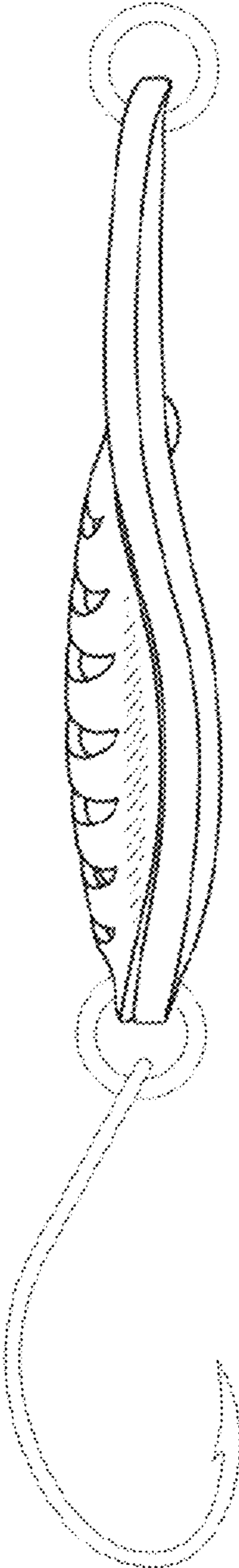

FIG. 5

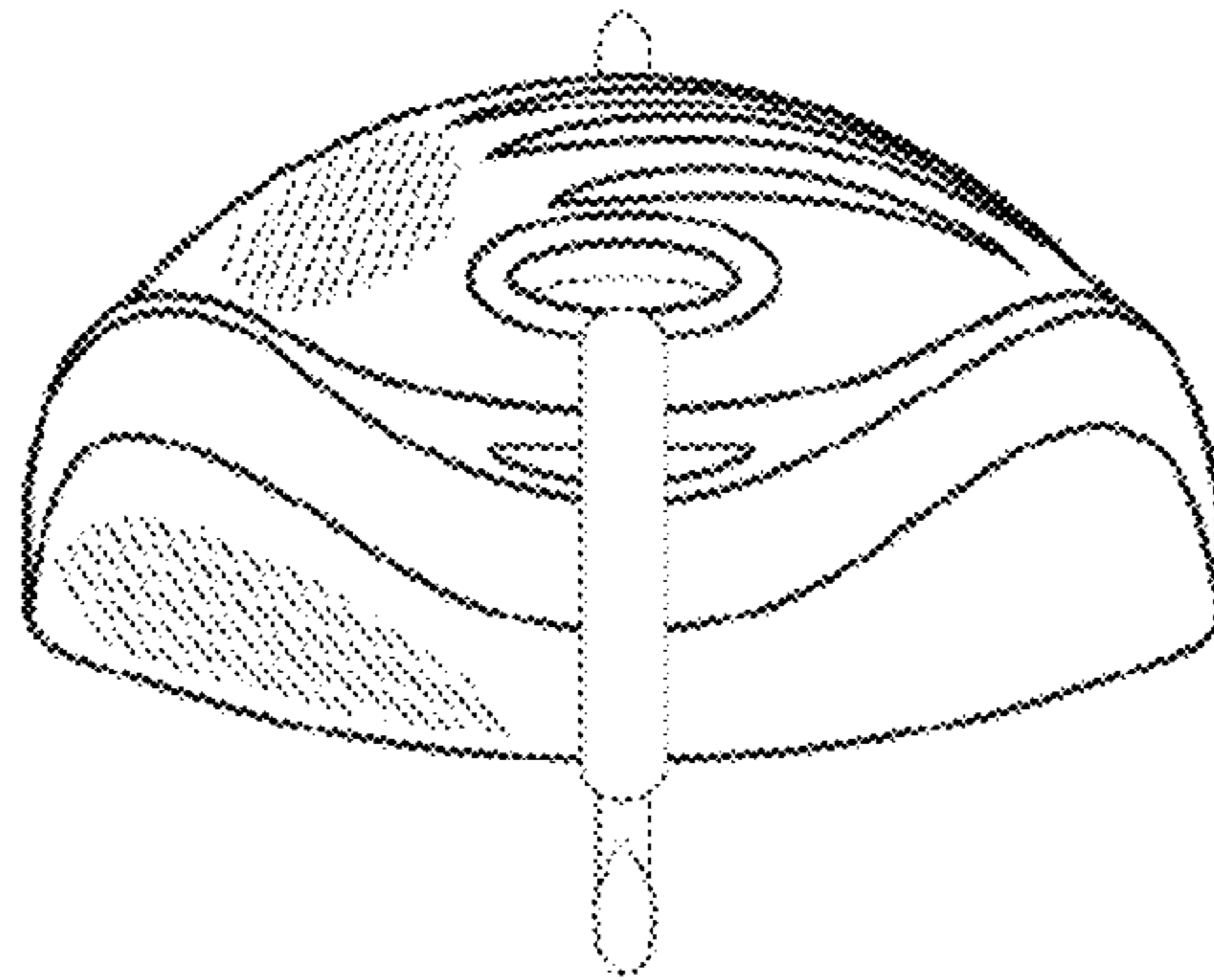

FIG. 6

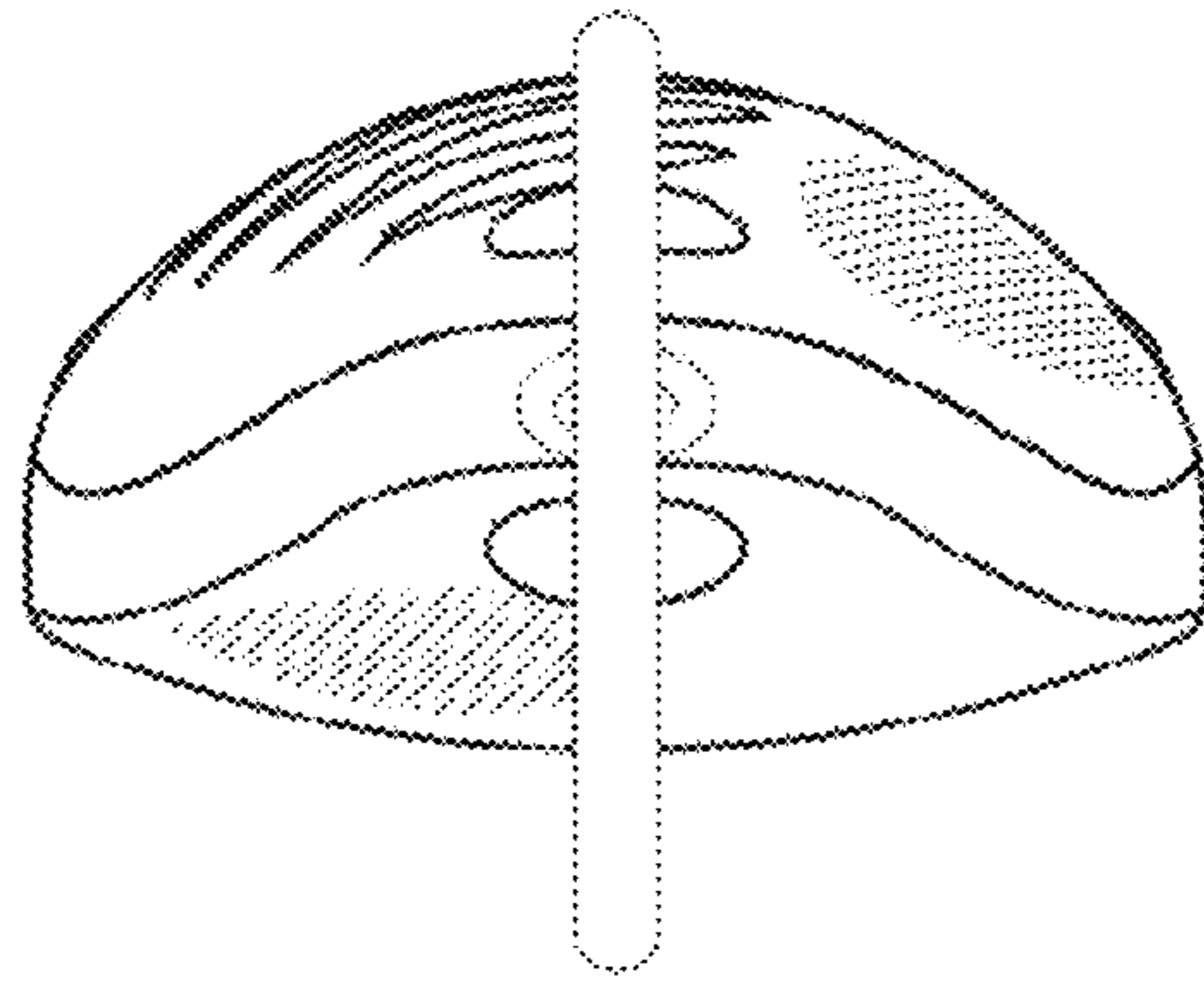

FIG. 7

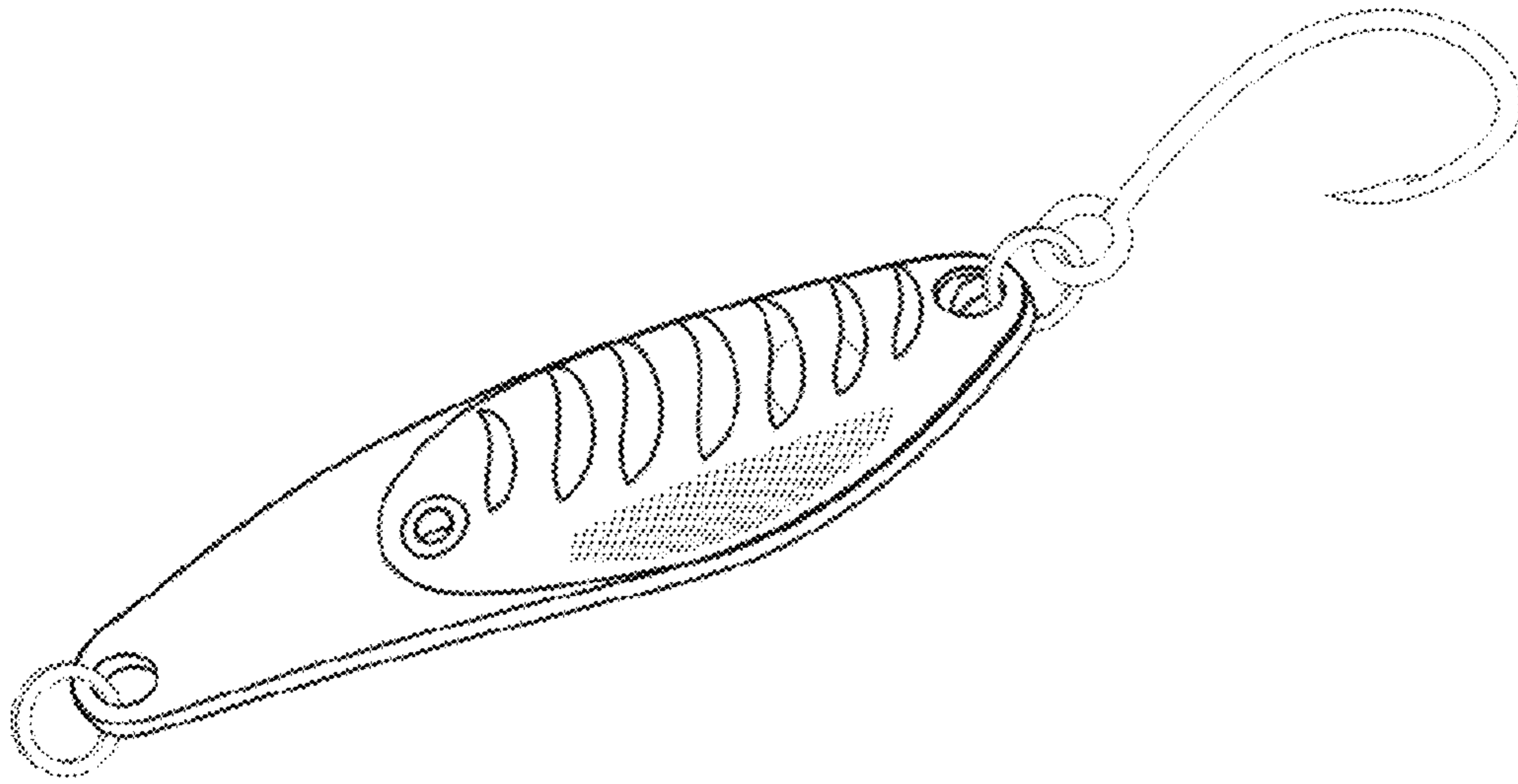

FIG. 8

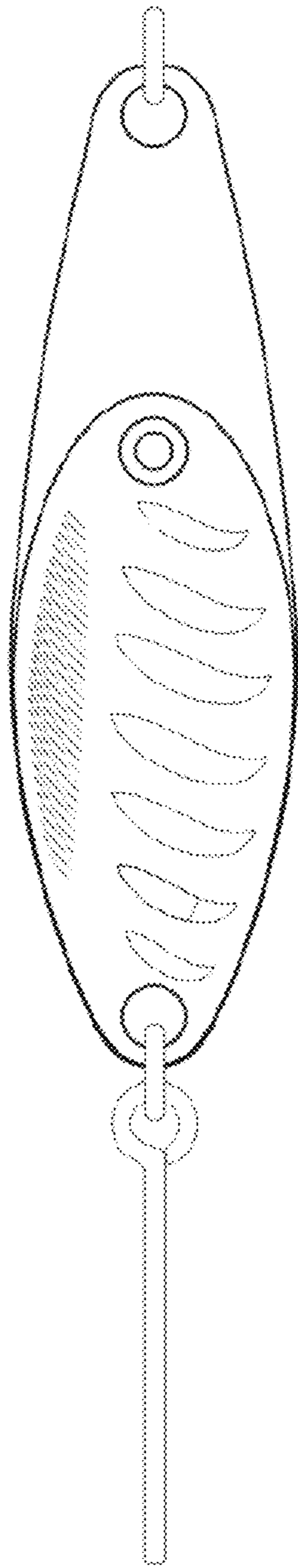

FIG. 9

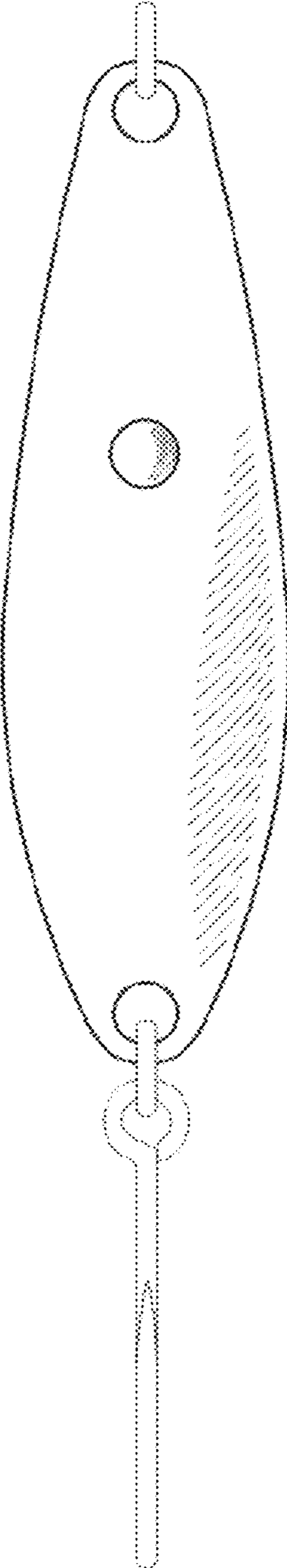

FIG. 10

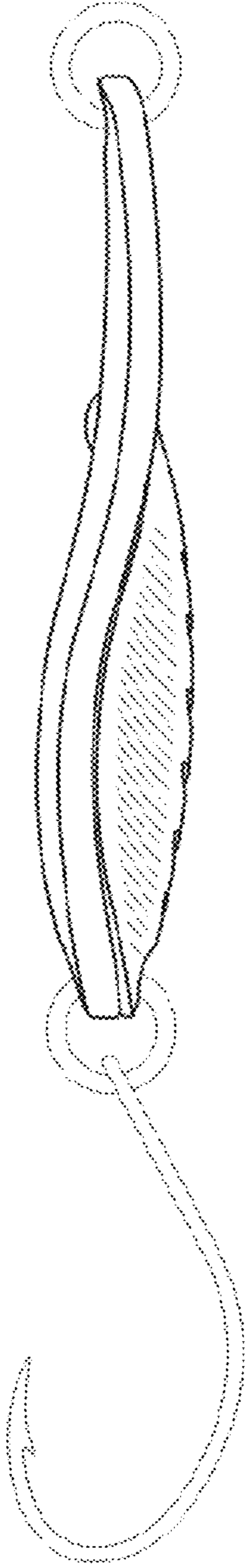

FIG. 11

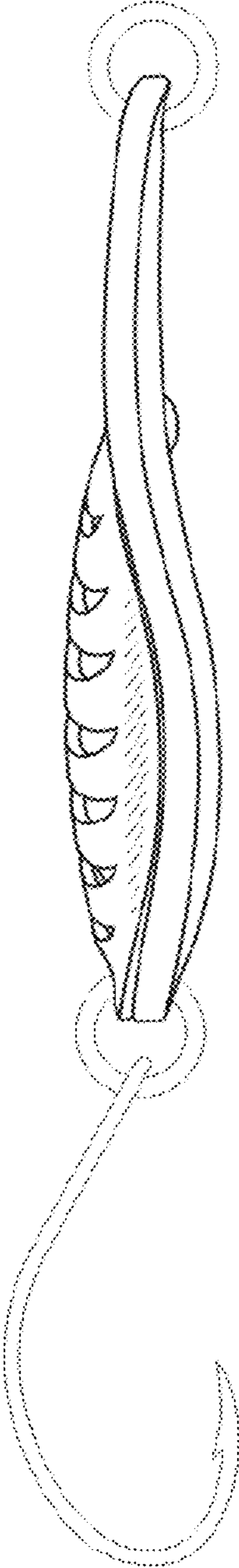

FIG. 12

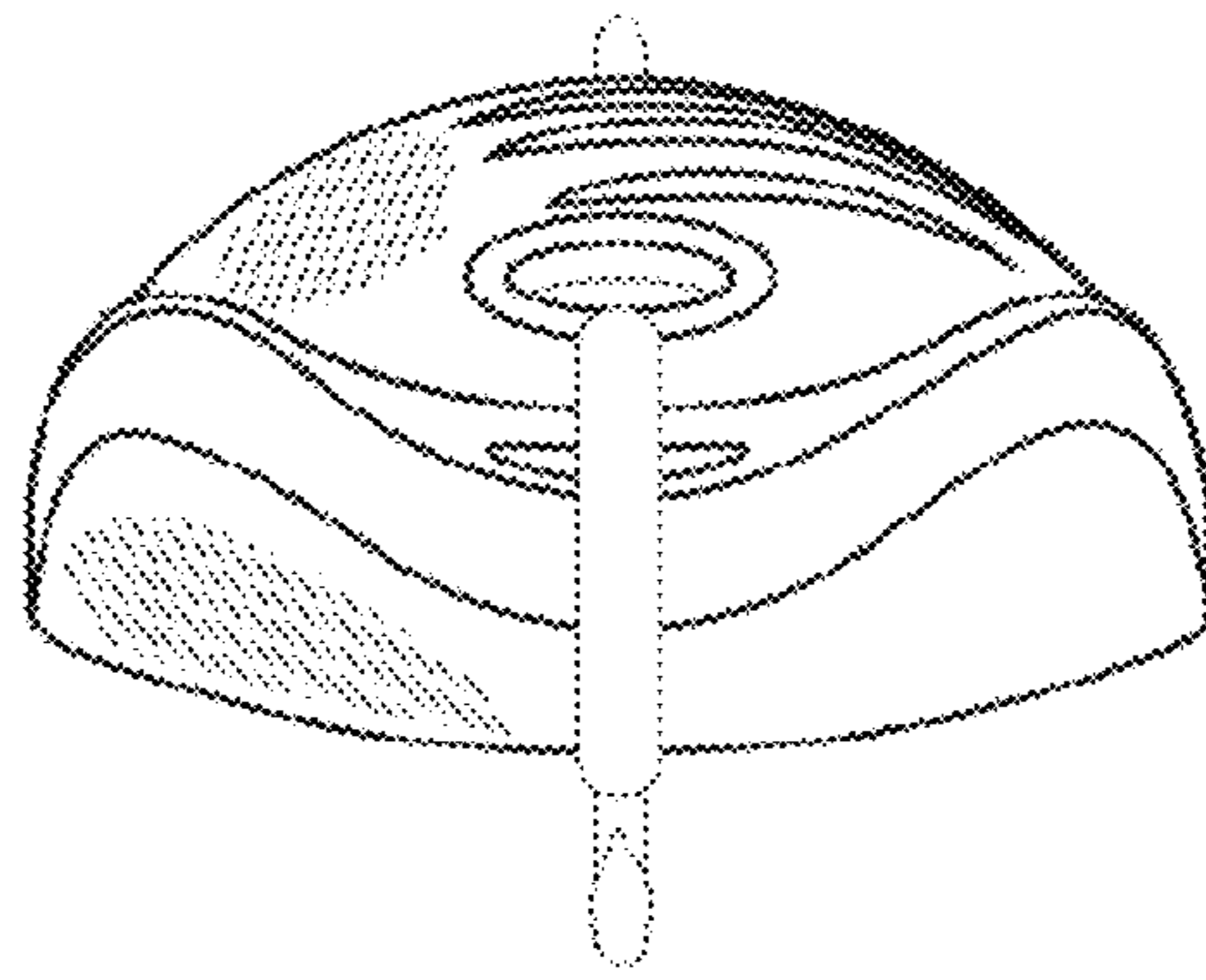

FIG. 13

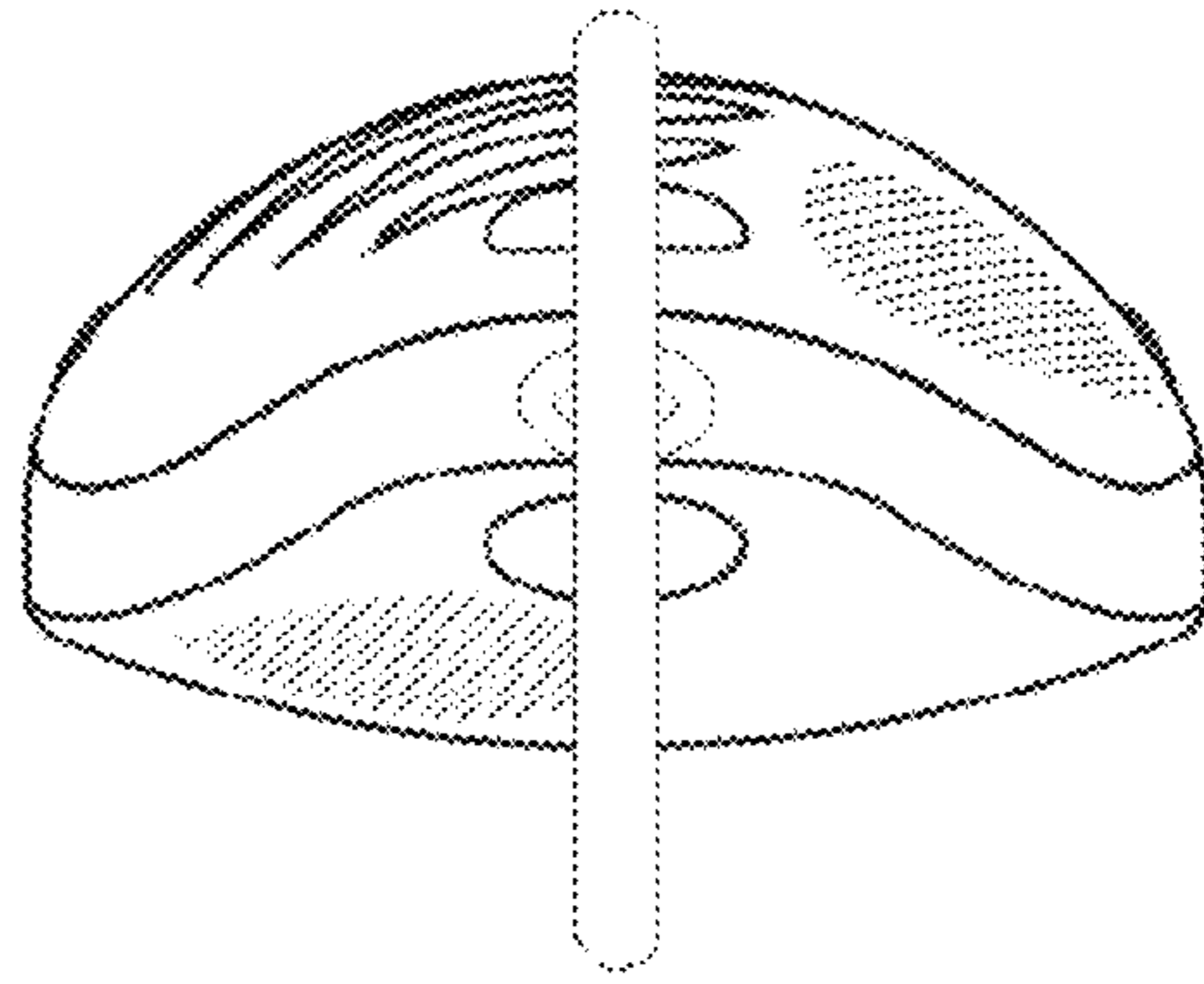

FIG. 14