



US00D707280S

(12) **United States Design Patent**
Tang

(10) **Patent No.:** **US D707,280 S**
(45) **Date of Patent:** **** Jun. 17, 2014**

(54) **MAGNIFIER**

(71) Applicant: **Hawk Importers, Inc.**, Long Beach, CA
(US)

(72) Inventor: **Freeman Tang**, Kowloon (CN)

(**) Term: **14 Years**

(21) Appl. No.: **29/453,979**

(22) Filed: **May 3, 2013**

(51) **LOC (10) Cl.** **16-06**

(52) **U.S. Cl.**

CPC **G02B 25/02** (2013.01)

USPC **D16/135**

(58) **Field of Classification Search**

USPC D16/135; 359/802, 803, 805, 808, 809,
359/810, 811, 812, 727; D3/12, 13, 5;
D8/102, 107; D26/33, 34; D28/64.4;
D7/395; 16/110.1, 430

See application file for complete search history.

(56) **References Cited**

U.S. PATENT DOCUMENTS

37,333	A *	1/1863	Clough et al.	81/492
2,322,441	A *	6/1943	Holliday	359/812
2,373,610	A *	4/1945	Stegeman	359/812
D153,817	S *	5/1949	Mortrude	D7/395
D333,313	S *	2/1993	Hornschiu et al.	D16/135
D345,568	S *	3/1994	Feinbloom et al.	D16/136
D350,551	S *	9/1994	Feinbloom	D16/135
D350,761	S *	9/1994	Feinbloom	D16/135
D394,073	S *	5/1998	Hennessy et al.	D16/135
D395,907	S *	7/1998	Calello	D16/135
D428,570	S *	7/2000	Lamond et al.	D8/107
D549,045	S *	8/2007	Silverstein	D7/395

D589,071	S *	3/2009	Jim	D16/135
D677,878	S *	3/2013	Headley	D3/12
D686,266	S *	7/2013	Baheti	D16/135

* cited by examiner

Primary Examiner — Paula Greene

(74) *Attorney, Agent, or Firm* — J. Curtis Edmondson; Law
Offices of J. Curtis Edmondson

(57) **CLAIM**

I claim the ornamental design for a magnifier, as shown and
described.

DESCRIPTION

FIG. 1 is a top perspective view of the magnifier.
 FIG. 2 is a top view of the magnifier.
 FIG. 3 is a bottom view of the magnifier.
 FIG. 4 is a left side view of the magnifier.
 FIG. 5 is a right side view of the magnifier.
 FIG. 6 is a view of the magnifier looking towards the handle.
 FIG. 7 is a view of the magnifier looking towards the lens.
 FIG. 8 is a top perspective view of the magnifier with a small
 lens embodiment.
 FIG. 9 is a top view of the magnifier with a small lens embodi-
 ment.
 FIG. 10 is a bottom view of the magnifier with a small lens
 embodiment.
 FIG. 11 is a left side view of the magnifier with a small lens
 embodiment.
 FIG. 12 is a right side view of the magnifier with a small lens
 embodiment.
 FIG. 13 is a view of the magnifier looking towards the handle
 with a small lens embodiment; and,
 FIG. 14 is a view of the magnifier looking towards the lens
 with a small lens embodiment.
 The broken lines form no part of the claimed design.

1 Claim, 14 Drawing Sheets

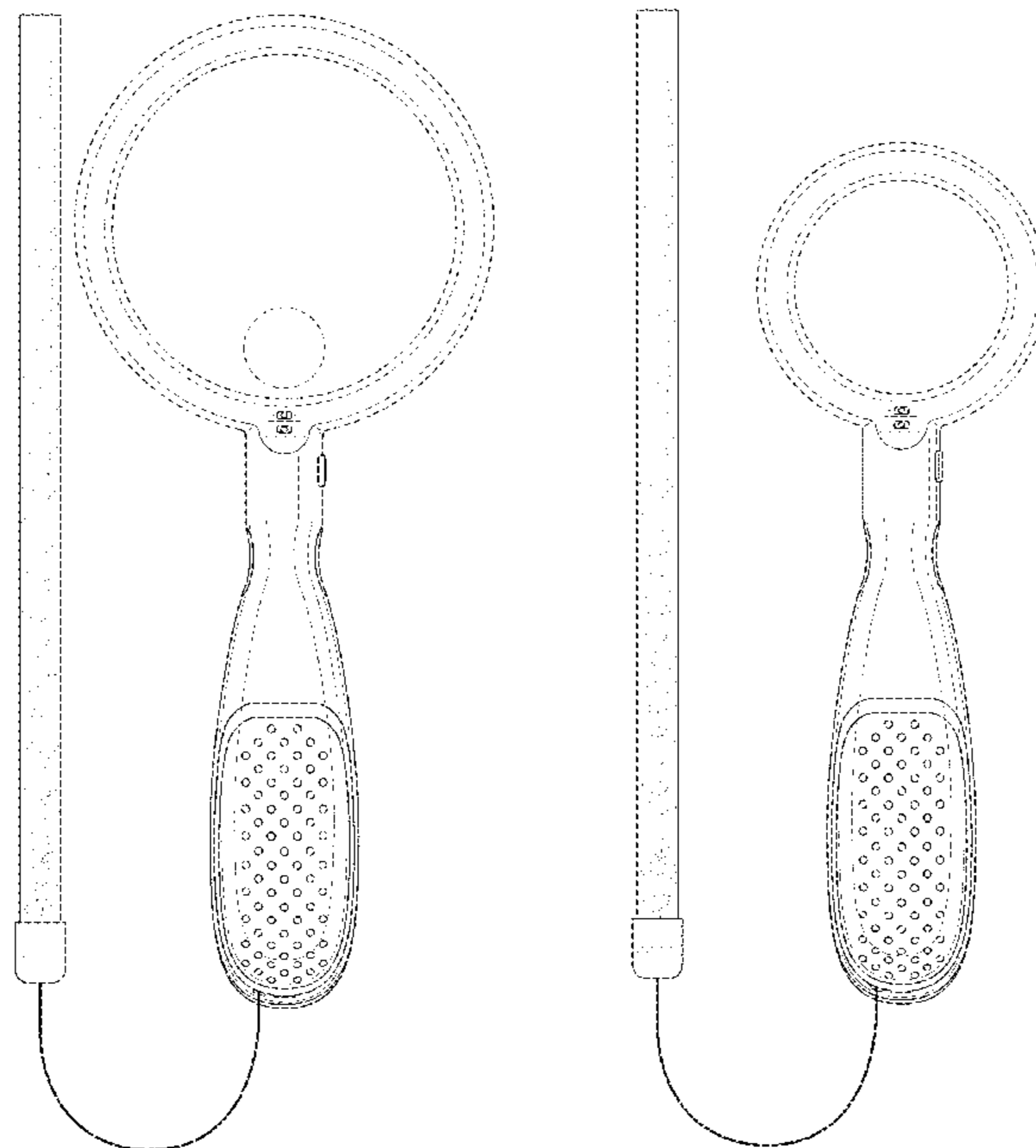

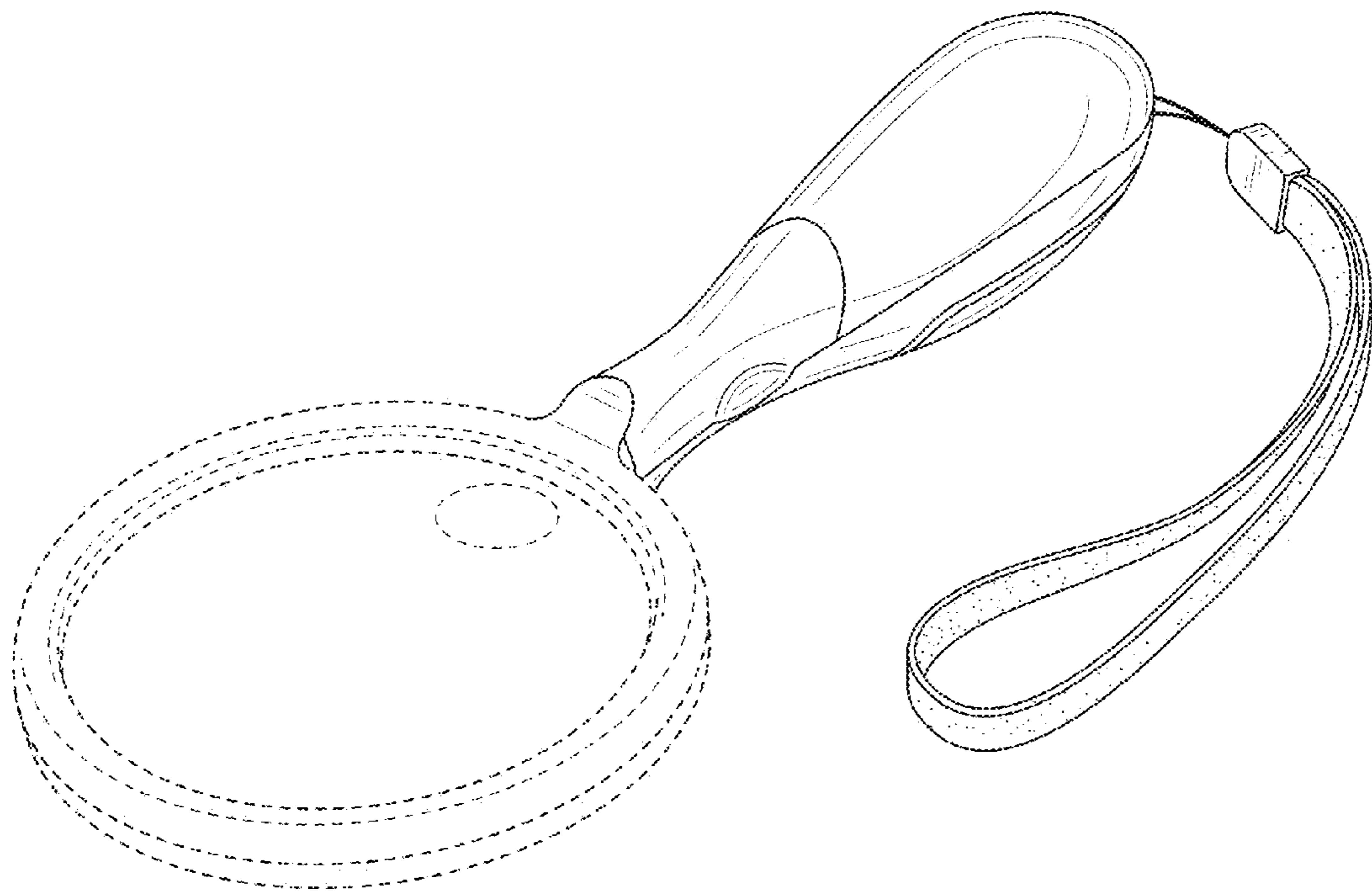

FIG. 1

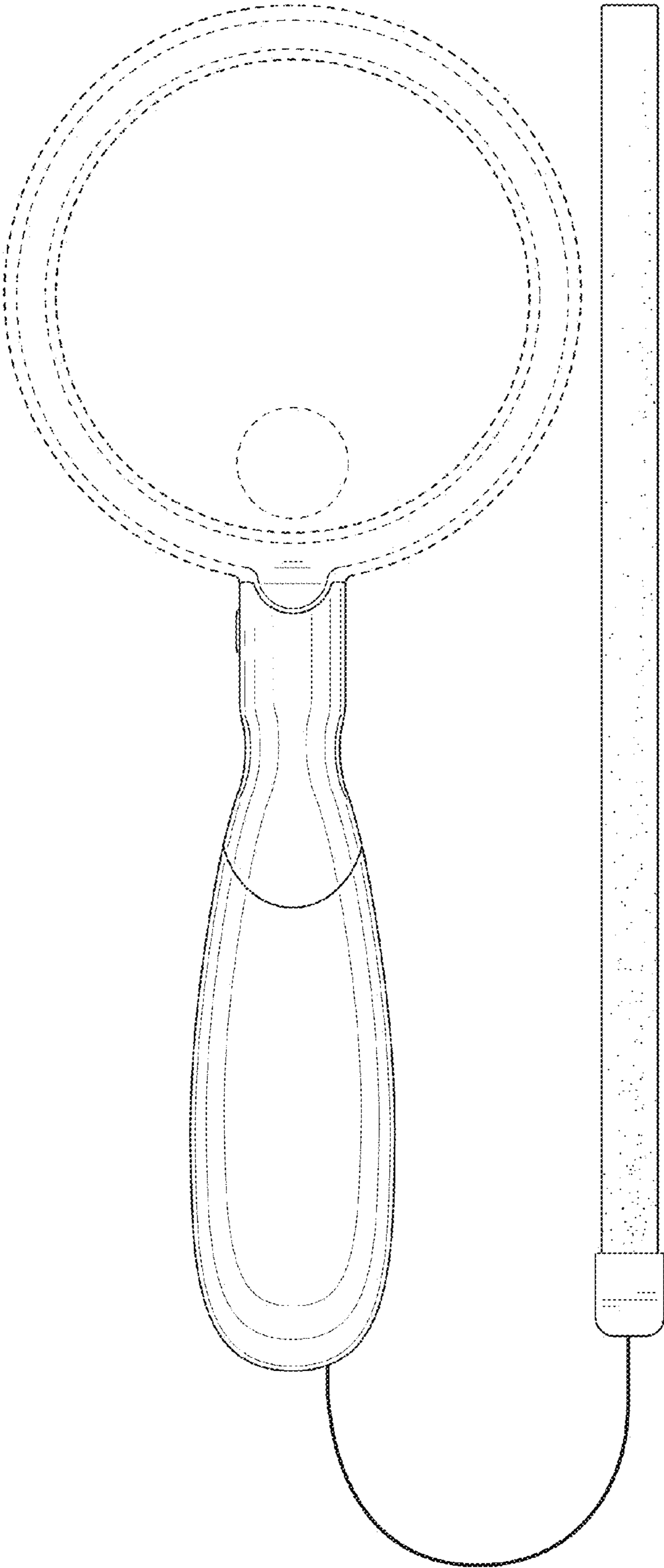

FIG. 2

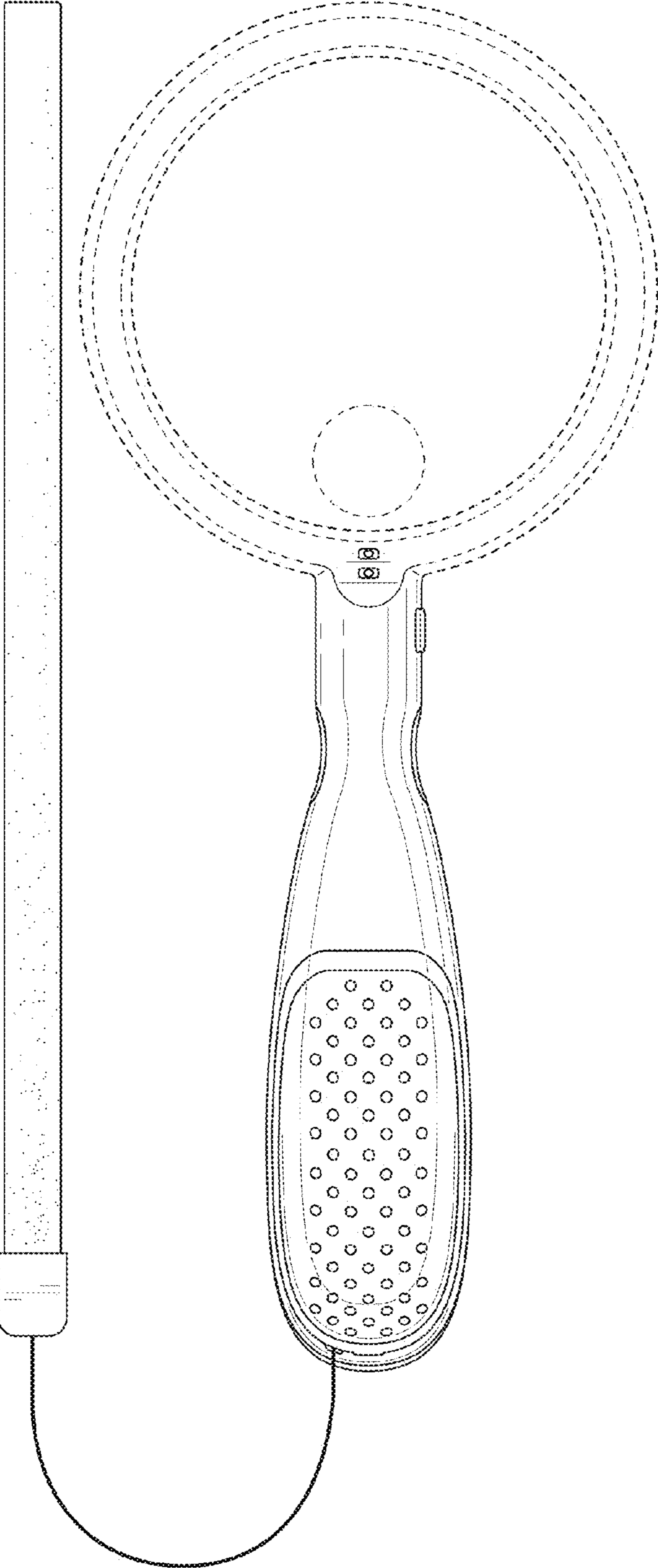

FIG. 3

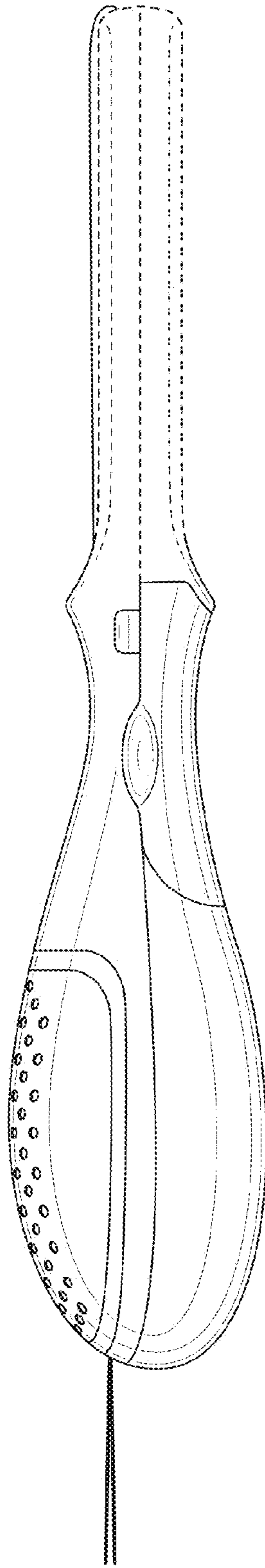

FIG. 4

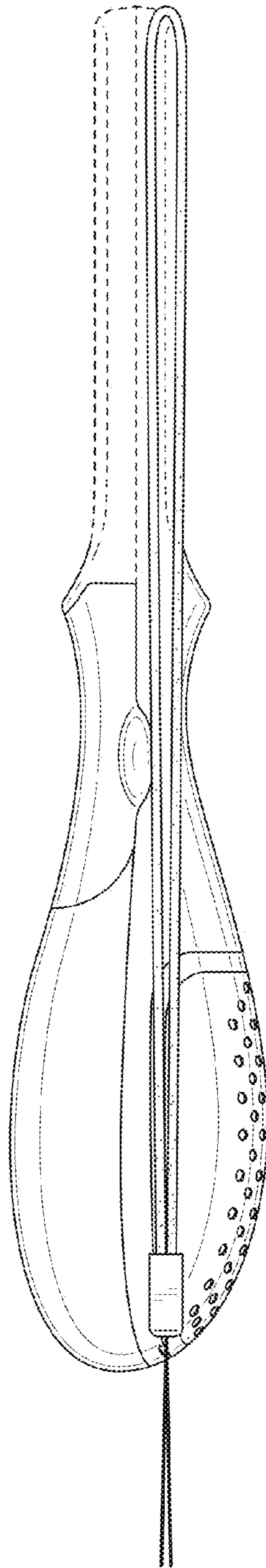

FIG. 5

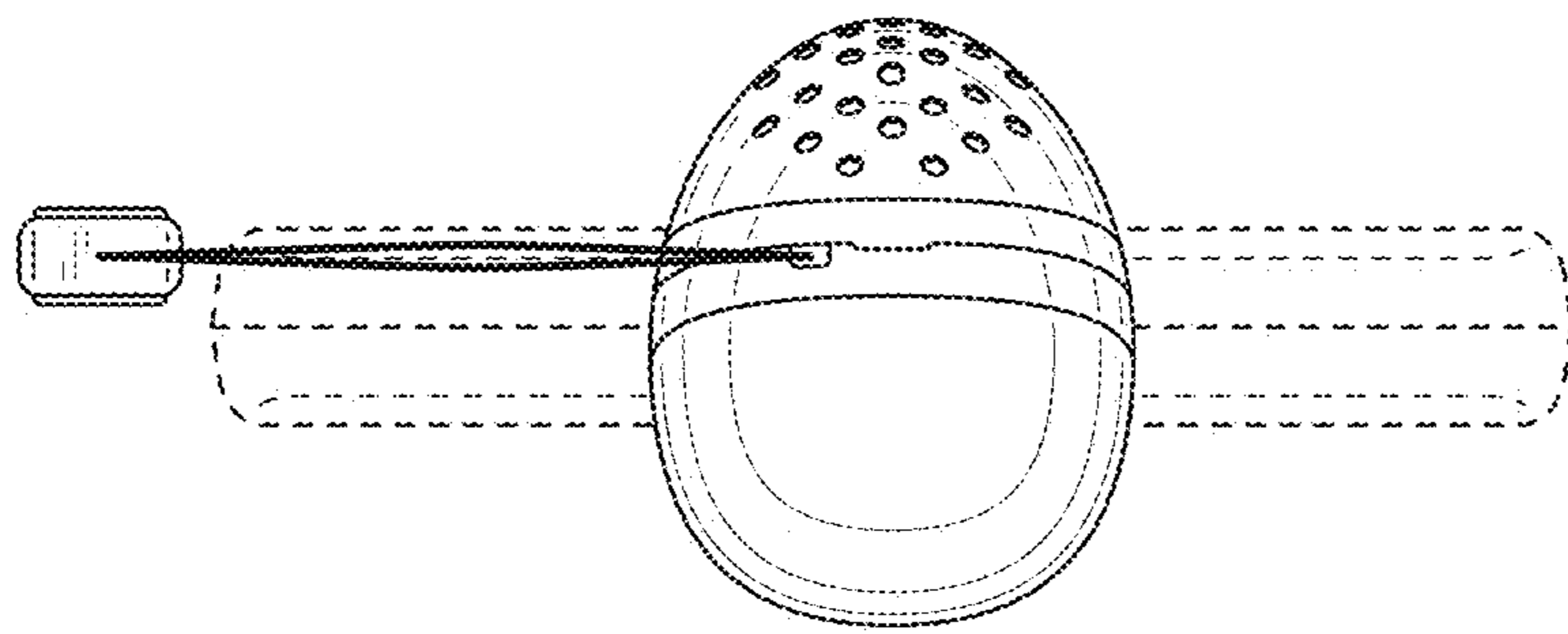

FIG. 6

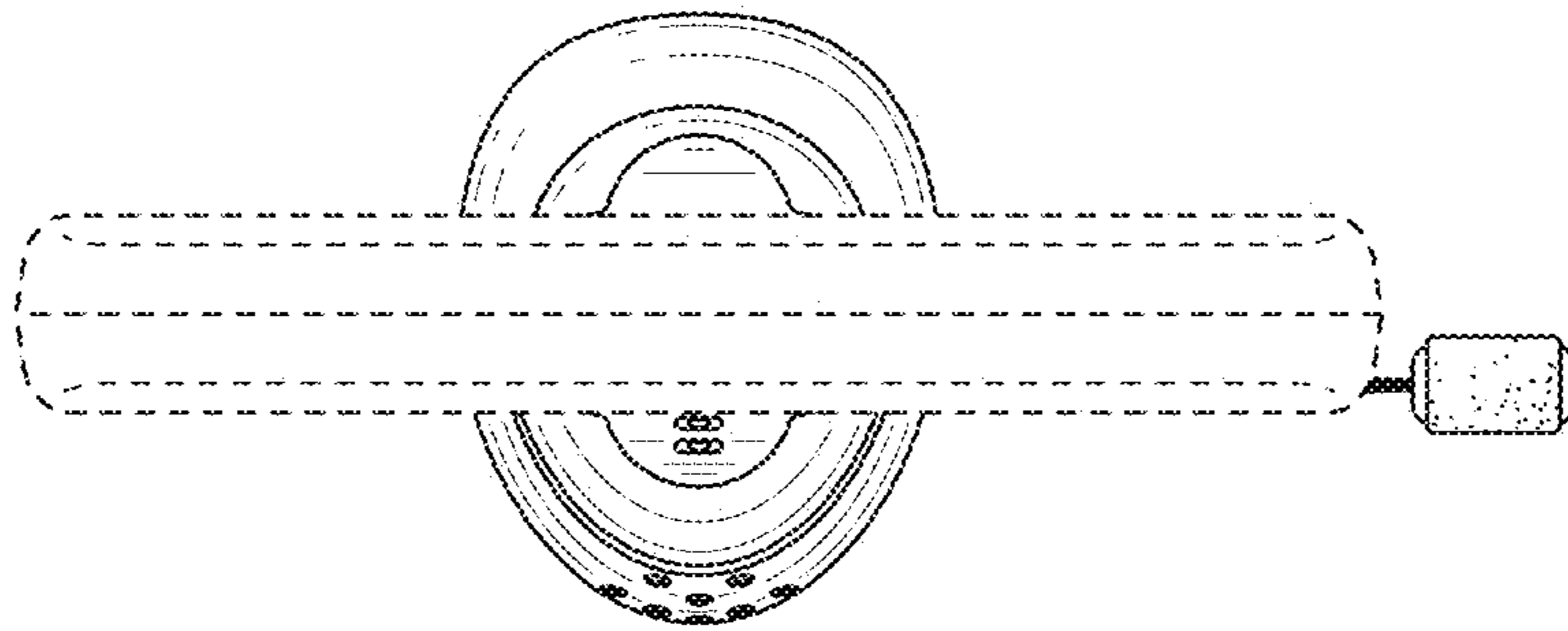

FIG. 7

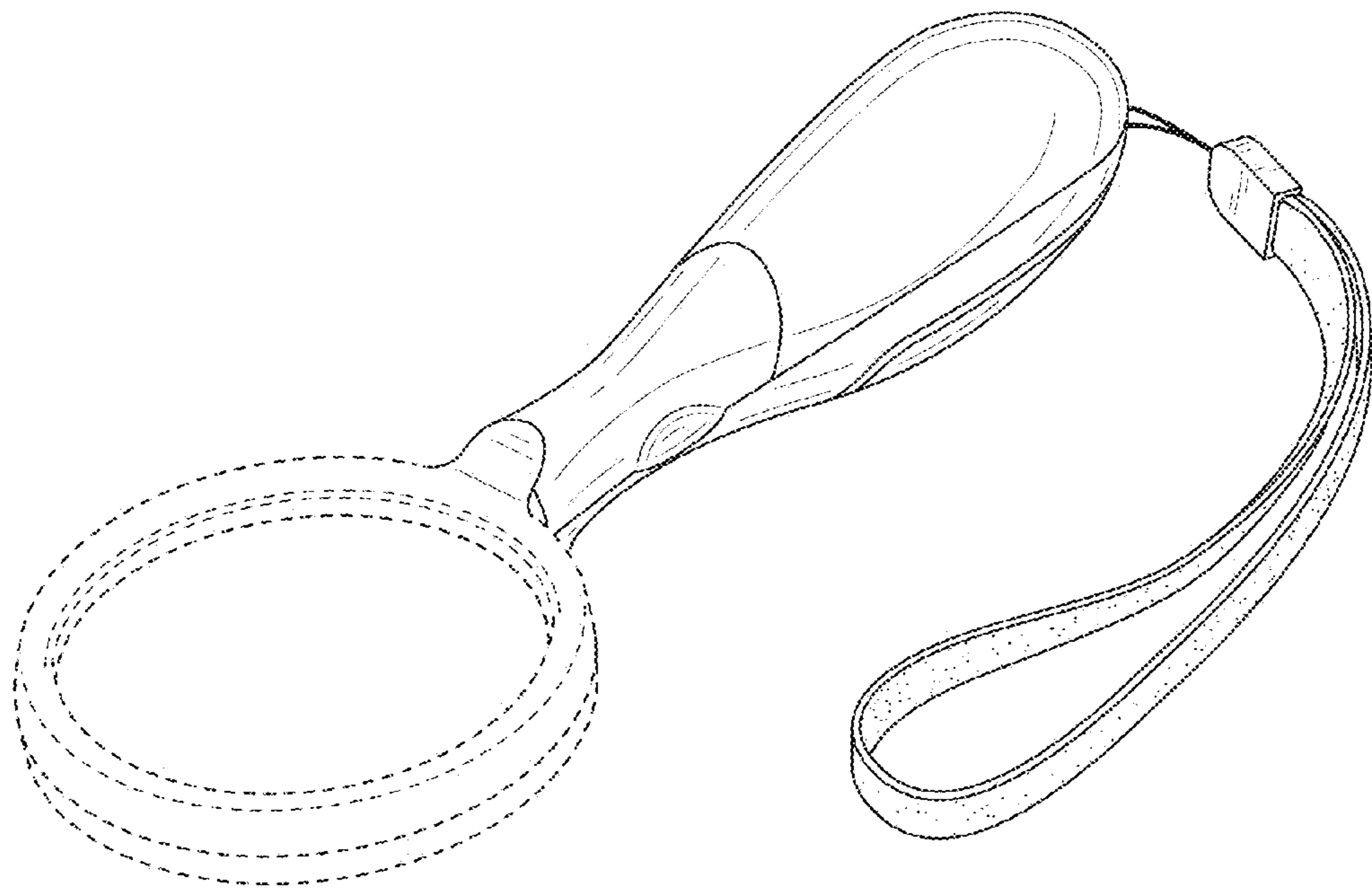

FIG. 8

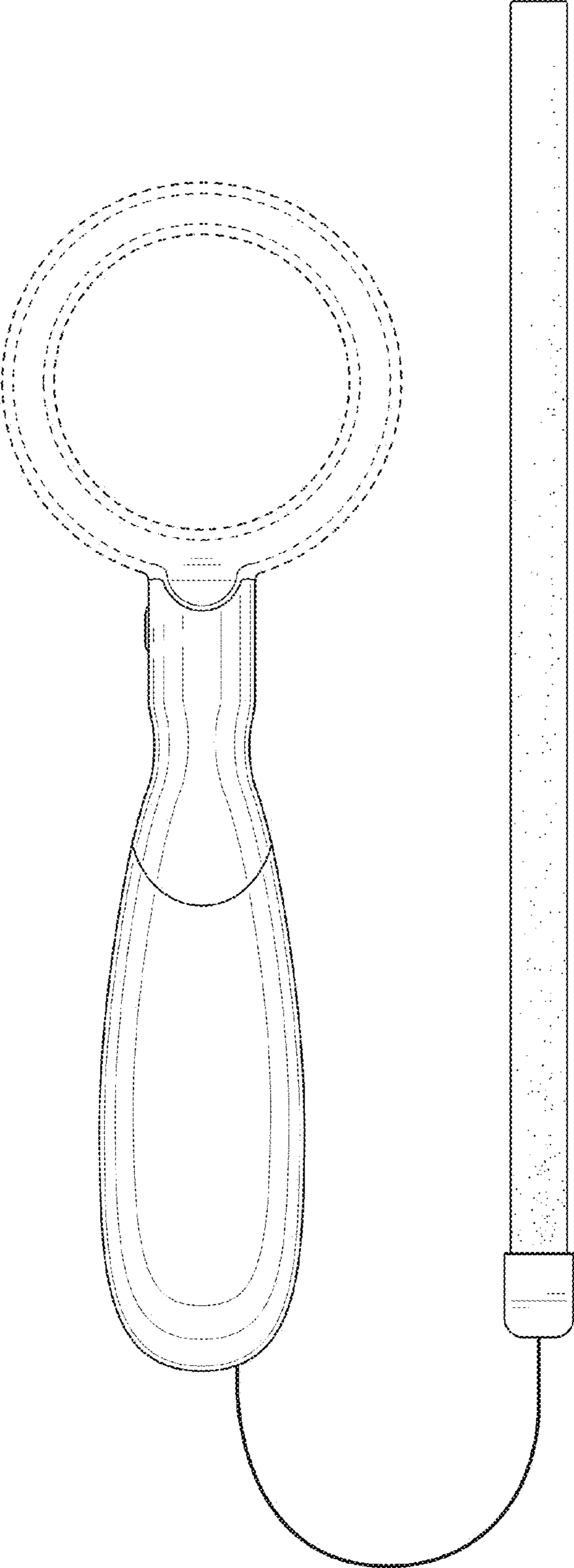

FIG. 9

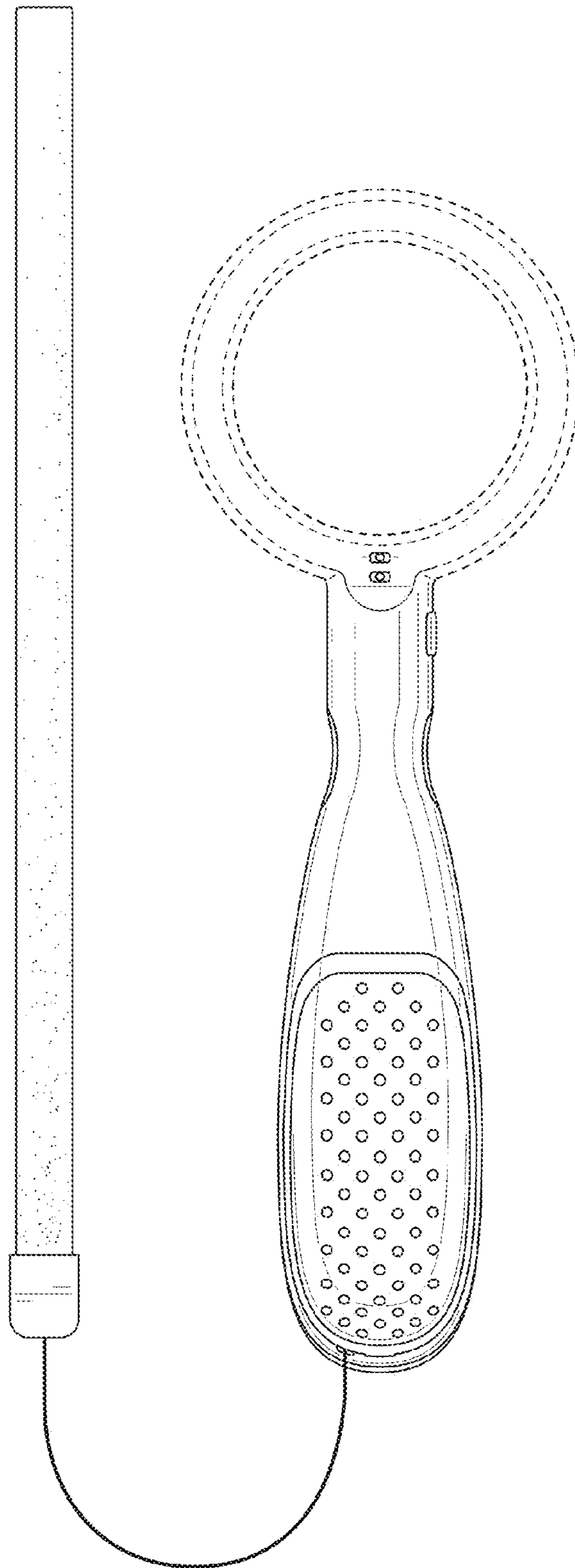

FIG. 10

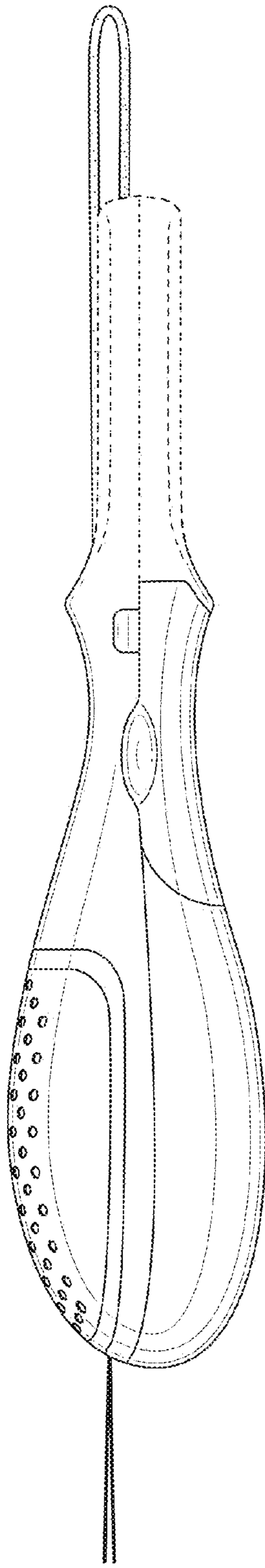

FIG. 11

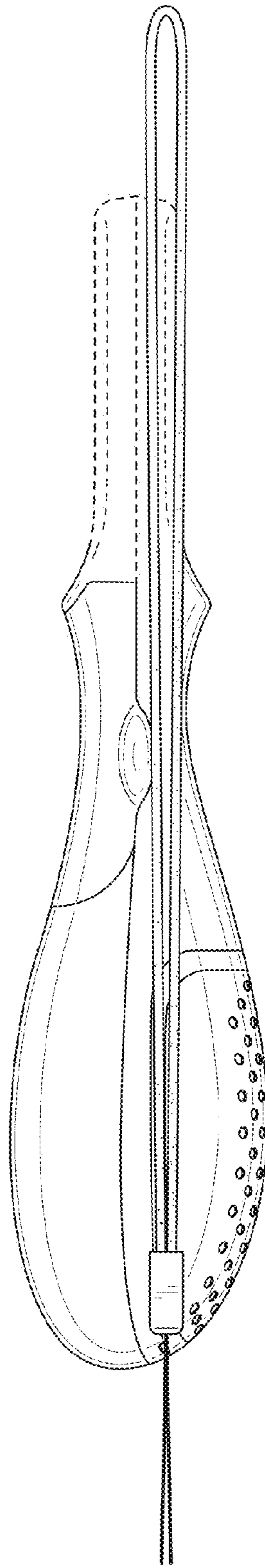

FIG. 12

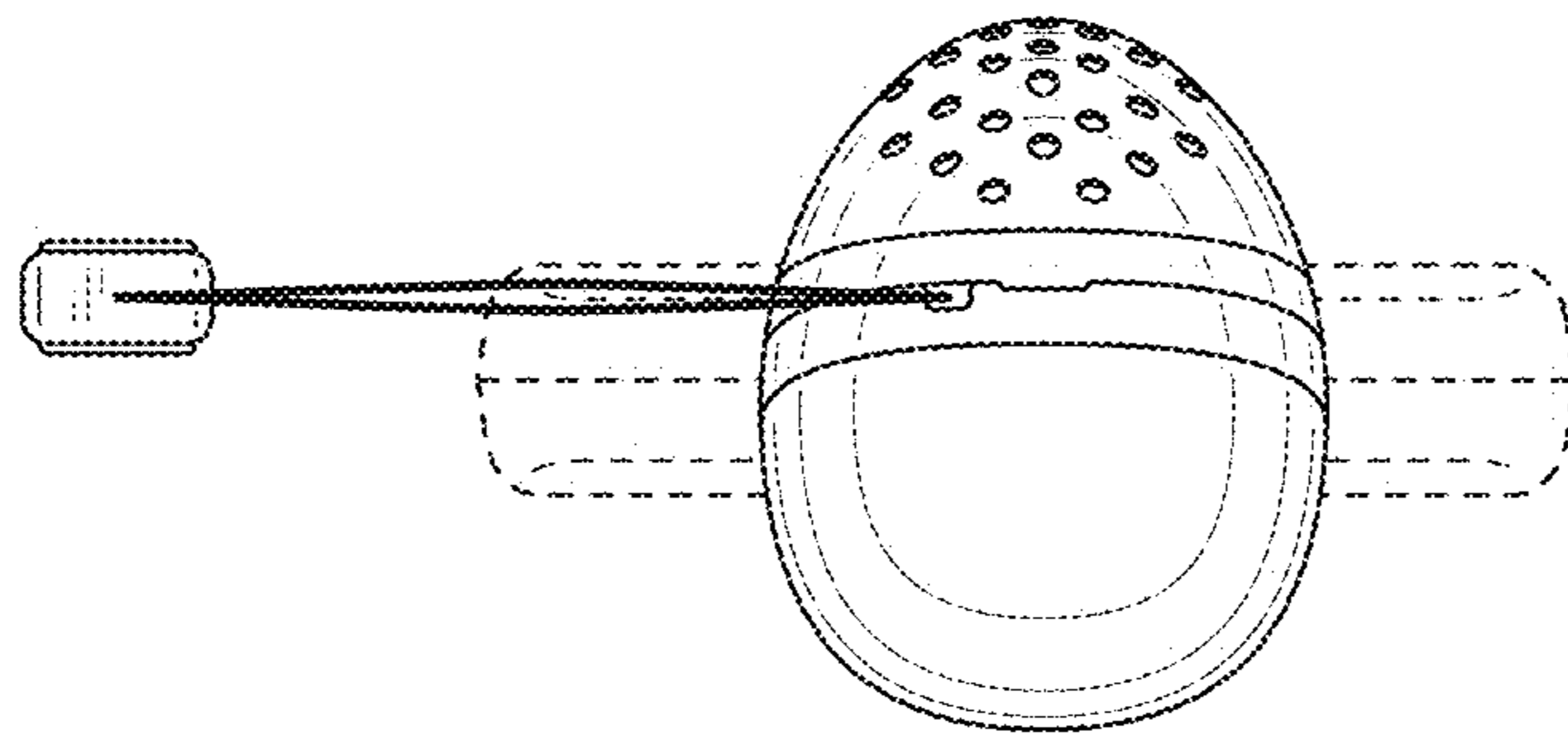

FIG. 13

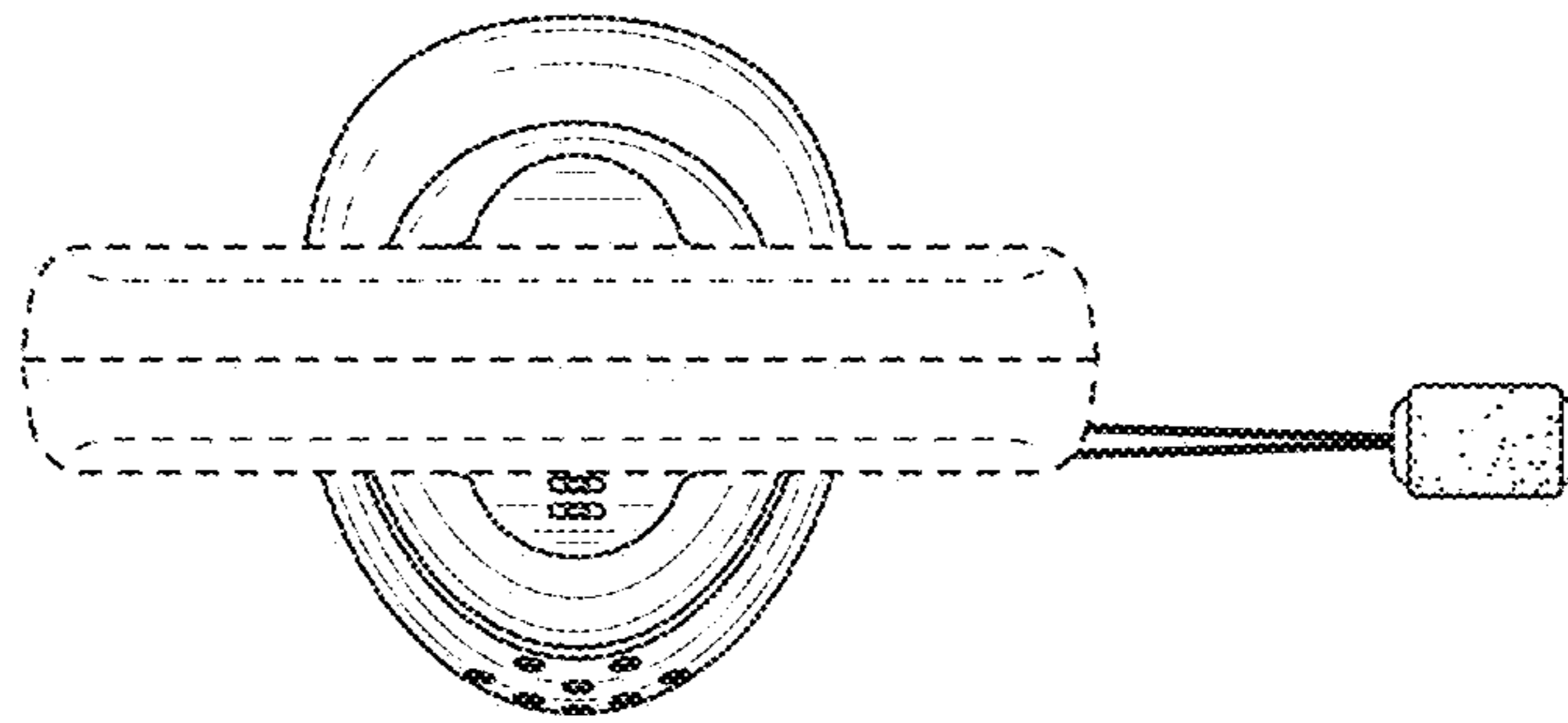

FIG. 14