



US00D707223S

(12) **United States Design Patent**
Akana et al.

(10) **Patent No.:** **US D707,223 S**
(45) **Date of Patent:** **** Jun. 17, 2014**

(54) **ELECTRONIC DEVICE**

(75) Inventors: **Jody Akana**, San Francisco, CA (US);
Bartley K. Andre, Menlo Park, CA
(US); **Jeremy Bataillou**, San Francisco,
CA (US); **Daniel J. Coster**, San
Francisco, CA (US); **Daniele De Iuliis**,
San Francisco, CA (US); **M. Evans**
Hankey, San Francisco, CA (US);
Julian Hoenig, San Francisco, CA (US);
Richard P. Howarth, San Francisco, CA
(US); **Jonathan P. Ive**, San Francisco,
CA (US); **Duncan Robert Kerr**, San
Francisco, CA (US); **Shin Nishibori**,
Kailua, HI (US); **Matthew Dean**
Rohrbach, San Francisco, CA (US);
Peter Russell-Clarke, San Francisco,
CA (US); **Christopher J. Stringer**,
Woodside, CA (US); **Eugene Antony**
Whang, San Francisco, CA (US); **Rico**
Zorkendorfer, San Francisco, CA (US)

(73) Assignee: **Apple Inc.**, Cupertino, CA (US)

(**) Term: **14 Years**

(21) Appl. No.: **29/423,180**

(22) Filed: **May 29, 2012**

(51) **LOC (10) Cl.** **14-02**

(52) **U.S. Cl.**
USPC **D14/341**

(58) **Field of Classification Search**

USPC D14/341-347, 137, 138 AA, 138 R,
D14/138 C, 138 G, 496, 203.1, 203.3, 203.7,
D14/426, 129, 130, 420, 147, 218, 247-248,
D14/389, 388, 315-318; D10/65, 104.1;
D18/6-7; D21/324, 329, 330;
455/556.1, 556.2, 566, 575.1, 90.3;
379/433.04, 433.01, 433.06, 916;
345/173, 901, 905; 361/679.26,
361/679.27, 679.3, 679.55, 679.56,
361/680-686; 248/917-924; 348/373, 376;
D19/60

See application file for complete search history.

(56) **References Cited**

U.S. PATENT DOCUMENTS

2,424,630 A 7/1947 Perez
D262,151 S 12/1981 Sussman

(Continued)

FOREIGN PATENT DOCUMENTS

AU 315078 7/2007
CA 72548 5/1993

(Continued)

OTHER PUBLICATIONS

Apple.com, "Apple—iPhone—Gallery," (<http://web.archive.org/web/20070705201012/http://www.apple.com/iphone/gallery/index8.html>), dated Jul. 5, 2007, accessed Mar. 28, 2013, 1 page.

(Continued)

Primary Examiner — Barbara Fox

(74) *Attorney, Agent, or Firm* — Sterne, Kessler, Goldstein & Fox P.L.L.C.

(57) **CLAIM**

The ornamental design for an electronic device, as shown and described.

DESCRIPTION

FIG. 1 is a bottom front perspective view of an electronic device showing our new design;
FIG. 2 is a bottom rear perspective view thereof;
FIG. 3 is a top front perspective view thereof;
FIG. 4 is a top rear perspective view thereof;
FIG. 5 is a front view thereof;
FIG. 6 is a rear view thereof;
FIG. 7 is a top view thereof;
FIG. 8 is a bottom view thereof;
FIG. 9 is a left side view thereof; and,
FIG. 10 is a right side view thereof.
The shade lines in the Figures show contour and not surface ornamentation.

1 Claim, 10 Drawing Sheets

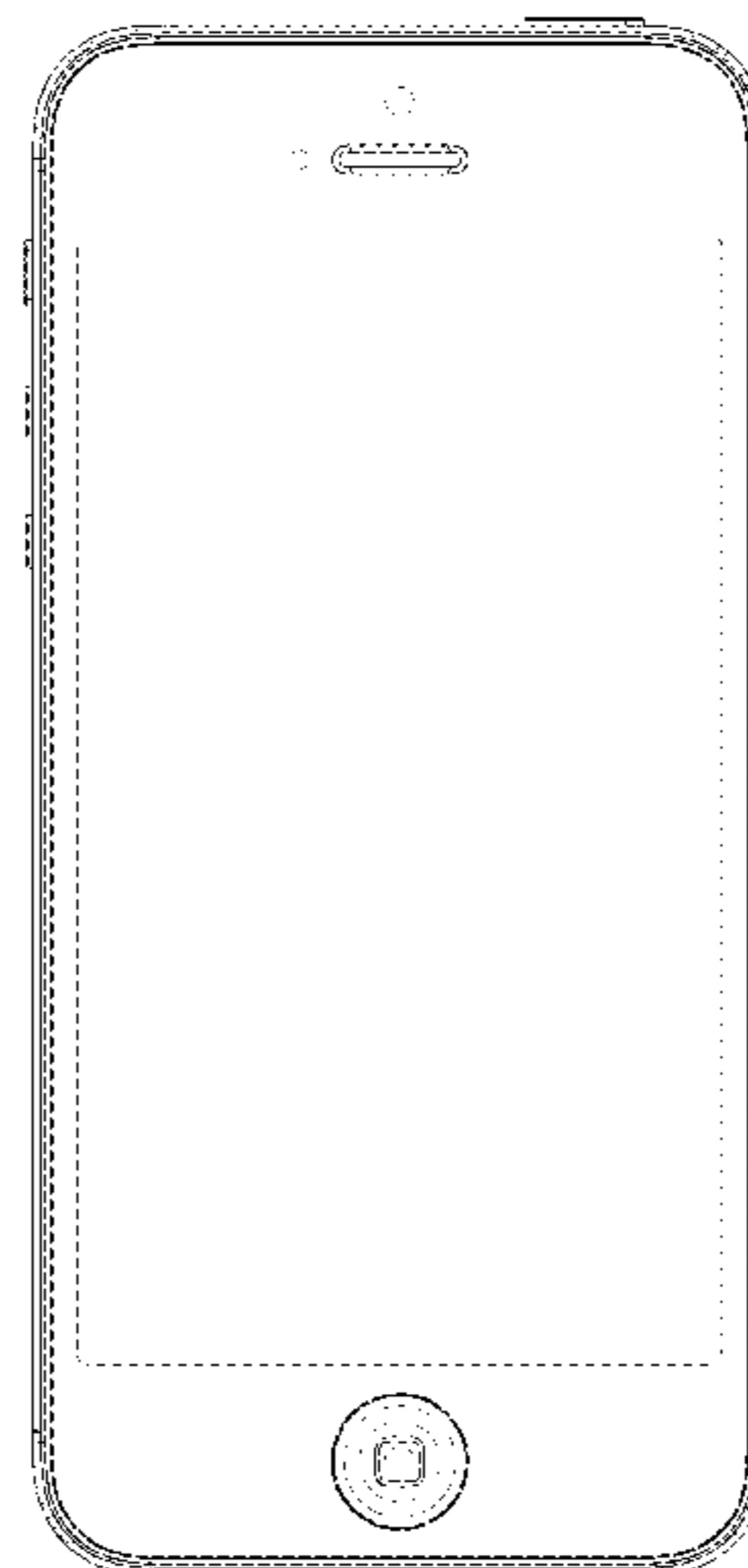
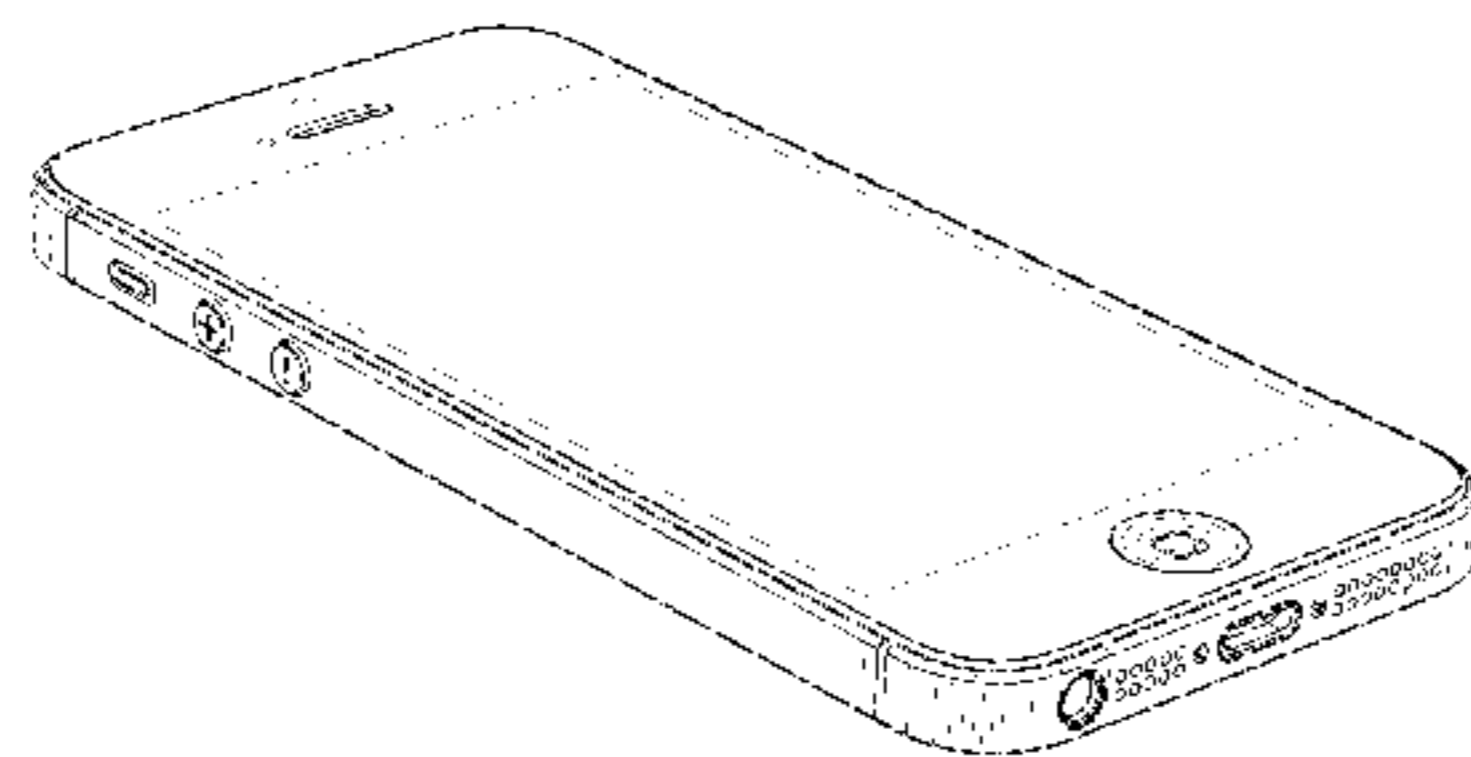

(56)

References Cited

U.S. PATENT DOCUMENTS

D265,326 S	7/1982	Sugiyama	D498,754 S	11/2004	Blyth
D270,061 S	8/1983	Ackeret	D499,423 S	12/2004	Bahroocha et al.
D270,062 S	8/1983	Ackeret	D500,037 S	12/2004	Ozolins et al.
D270,063 S	8/1983	Ackeret	D502,173 S	2/2005	Jung et al.
D270,066 S	8/1983	Ackeret	D502,945 S	3/2005	Huang et al.
D278,276 S	4/1985	Bakic	D503,699 S	4/2005	Lee et al.
D284,084 S	6/1986	Ferrara, Jr.	D504,889 S	5/2005	Andre et al.
D289,873 S	5/1987	Gemmell et al.	D505,950 S	6/2005	Summit et al.
D300,831 S	4/1989	Jenkins et al.	D507,003 S	7/2005	Pai et al.
D306,583 S	3/1990	Krolopp et al.	D509,202 S	9/2005	Lee et al.
D308,055 S	5/1990	Tedham et al.	D509,760 S	9/2005	Burrell et al.
D317,609 S	6/1991	Wei	D509,833 S	9/2005	Yang
D321,215 S	10/1991	Shamis	D510,929 S	10/2005	Laverick et al.
D332,328 S	1/1993	Lombardi, Jr.	D511,342 S	11/2005	Chien
D333,574 S	3/1993	Ackeret	D511,347 S	11/2005	Naruki
D337,322 S	7/1993	Yang	D513,617 S	1/2006	Tierney
D337,569 S	7/1993	Kando	D514,121 S	1/2006	Johnson
D340,701 S	10/1993	Takeuchi	D514,558 S	2/2006	Nagel et al.
D340,917 S	11/1993	Sakaguchi et al.	D514,590 S	2/2006	Naruki
D345,346 S	3/1994	Alfonso et al.	D519,116 S	4/2006	Tanaka et al.
D346,589 S	5/1994	Andros	D519,523 S	4/2006	Chiu et al.
D346,793 S	5/1994	Iino et al.	D519,998 S	5/2006	Park
5,345,543 A	9/1994	Capps et al.	D520,020 S	5/2006	Senda et al.
5,398,310 A	3/1995	Tchao et al.	D521,023 S	5/2006	Kim et al.
D361,552 S	8/1995	Iino	7,042,712 B2	5/2006	Ghosh et al.
5,463,725 A	10/1995	Henckel et al.	D524,809 S	7/2006	Alcouloumre et al.
5,495,566 A	2/1996	Kwatinetz	D525,226 S	7/2006	Jang
D395,639 S	6/1998	Ham et al.	D525,620 S	7/2006	Esslinger et al.
D396,215 S	7/1998	Inukai	D525,987 S	8/2006	Kim
D396,452 S	7/1998	Naruki	D526,301 S	8/2006	Shin
D408,372 S	4/1999	Ota et al.	D526,302 S	8/2006	Kim
D408,794 S	4/1999	Ogasawara	D527,015 S	8/2006	Yang
D409,185 S	5/1999	Kawashima	D527,366 S	8/2006	Lee
D410,440 S	6/1999	Carnell	D528,542 S	9/2006	Luminosu et al.
D420,354 S	2/2000	Morales	D528,561 S	9/2006	Ka-Wei et al.
D424,535 S	5/2000	Peltola	D529,045 S	9/2006	Shin
D425,887 S	5/2000	Edwards et al.	D530,699 S	10/2006	Lee et al.
6,061,063 A	5/2000	Wagner et al.	D531,610 S	11/2006	Kim et al.
6,067,068 A	5/2000	Hussain	D532,766 S	11/2006	Lee
D444,465 S	7/2001	Do	D532,791 S	11/2006	Kim
D448,764 S	10/2001	Marsalka et al.	D533,531 S	12/2006	Hyun et al.
6,310,610 B1	10/2001	Beaton et al.	D534,143 S	12/2006	Lheem
D451,505 S	12/2001	Iseki et al.	D534,145 S	12/2006	Lheem
D452,687 S	1/2002	Yeh	D534,516 S	1/2007	Lheem
6,337,698 B1	1/2002	Keely, Jr. et al.	D534,517 S	1/2007	Cho et al.
D453,333 S	2/2002	Chen	D535,281 S	1/2007	Yang
D454,348 S	3/2002	Yeh	D536,329 S	2/2007	Lee
D455,433 S	4/2002	Alviar et al.	D536,691 S	2/2007	Park
D456,023 S	4/2002	Andre et al.	D536,962 S	2/2007	Tanner
D456,805 S	5/2002	Ono et al.	D538,822 S	3/2007	Andre et al.
D458,252 S	6/2002	Palm et al.	D541,298 S	4/2007	Andre et al.
D461,175 S	8/2002	Yokota	D541,299 S	4/2007	Andre et al.
D461,802 S	8/2002	Tu	D541,785 S	5/2007	Hwang et al.
D466,501 S	12/2002	Hirota	D543,183 S	5/2007	Cho et al.
D467,890 S	12/2002	Lai et al.	D546,313 S	7/2007	Lheem
6,501,967 B1	12/2002	Makela et al.	D548,713 S	8/2007	Lee et al.
D469,413 S	1/2003	To et al.	D548,732 S	8/2007	Cebe et al.
6,509,907 B1	1/2003	Kuwabara	D548,747 S	8/2007	Andre et al.
D483,032 S	12/2003	Bertrand et al.	D554,098 S	10/2007	Lee
D483,359 S	12/2003	Lin et al.	D556,211 S	11/2007	Howard
D485,265 S	1/2004	Sato et al.	D557,238 S	12/2007	Kim
D486,149 S	2/2004	Kawami et al.	D557,239 S	12/2007	Lee
6,690,387 B2	2/2004	Zimmerman et al.	D557,259 S	12/2007	Hirsch
D488,468 S	4/2004	Hu	7,303,424 B2	12/2007	Tu et al.
D488,469 S	4/2004	Batsikas	D558,460 S	1/2008	Yu et al.
D489,062 S	4/2004	Hong	D558,716 S	1/2008	Bae et al.
D489,731 S	5/2004	Huang	D558,726 S	1/2008	Wang et al.
D490,810 S	6/2004	Huang	D558,756 S	1/2008	Andre et al.
D491,156 S	6/2004	Kawakami et al.	D558,757 S	1/2008	Andre et al.
D492,684 S	7/2004	Ozolins et al.	D558,758 S	1/2008	Andre et al.
D494,188 S	8/2004	Huang	D558,792 S	1/2008	Chigira
D495,695 S	9/2004	Yugaya	D559,220 S	1/2008	Lee et al.
D496,645 S	9/2004	Yoo et al.	D560,192 S	1/2008	Lee et al.
6,788,527 B2	9/2004	Doczy et al.	D560,227 S	1/2008	Bennett et al.
D497,364 S	10/2004	Ozolins et al.	D560,231 S	1/2008	Lee
			D560,683 S	1/2008	Lee
			D560,686 S	1/2008	Kim
			D561,153 S	2/2008	Hong et al.
			D561,204 S	2/2008	Toh

(56)

References Cited

U.S. PATENT DOCUMENTS

D561,782 S 2/2008 Kim
 D562,285 S 2/2008 Lim
 D563,432 S 3/2008 Kim
 D563,929 S 3/2008 Park
 D565,532 S 4/2008 Arnold
 D565,596 S 4/2008 Kim
 D565,599 S 4/2008 Jang et al.
 D567,819 S 4/2008 Devericks et al.
 D568,309 S 5/2008 Cebe et al.
 D569,629 S 5/2008 Yu et al.
 D569,830 S 5/2008 Kwak
 D570,346 S 6/2008 Suk et al.
 D570,839 S 6/2008 Hofer et al.
 D572,694 S 7/2008 Park
 D573,143 S 7/2008 Park et al.
 D574,015 S 7/2008 Masui
 D575,259 S 8/2008 Kim et al.
 7,409,059 B2 8/2008 Fujisawa
 D579,902 S 11/2008 Kim et al.
 D579,905 S 11/2008 Kim et al.
 D579,930 S 11/2008 Maskatia
 D580,387 S 11/2008 Andre et al.
 D581,922 S 12/2008 Andre et al.
 D583,346 S 12/2008 Jung et al.
 D583,796 S 12/2008 Tanaka
 D584,738 S 1/2009 Kim et al.
 D585,411 S 1/2009 Eaton
 D586,800 S 2/2009 Andre et al.
 D589,979 S 4/2009 Andre et al.
 D593,087 S 5/2009 Andre et al.
 D594,833 S 6/2009 Park
 D597,067 S 7/2009 Oh et al.
 D600,241 S 9/2009 Andre et al.
 D600,690 S 9/2009 Miyaji
 D601,558 S 10/2009 Andre et al.
 D601,583 S 10/2009 Andre et al.
 D602,014 S 10/2009 Andre et al.
 D602,015 S 10/2009 Andre et al.
 D602,016 S 10/2009 Andre et al.
 D602,017 S 10/2009 Andre et al.
 D602,486 S 10/2009 Andre et al.
 D602,488 S 10/2009 Jiang et al.
 D603,834 S 11/2009 Lyman et al.
 D604,297 S 11/2009 Andre et al.
 D604,716 S 11/2009 Oh et al.
 D605,157 S 12/2009 Kim et al.
 D606,129 S 12/2009 Ben-Moshe
 D607,428 S 1/2010 Kim et al.
 7,658,675 B2 2/2010 Hotta
 7,688,574 B2 3/2010 Zadesky et al.
 D613,735 S 4/2010 Andre et al.
 D613,736 S 4/2010 Andre et al.
 D615,083 S 5/2010 Andre et al.
 D620,004 S 7/2010 Andre et al.
 D621,825 S 8/2010 Andre et al.
 D622,718 S 8/2010 Andre et al.
 D622,719 S 8/2010 Andre et al.
 D622,720 S 8/2010 Andre et al.
 D624,072 S 9/2010 Andre et al.
 D624,536 S 9/2010 Andre et al.
 D626,437 S 11/2010 Lee et al.
 D627,343 S 11/2010 Andre et al.
 D627,777 S 11/2010 Akana et al.
 D627,778 S 11/2010 Akana et al.
 D629,799 S 12/2010 Andre et al.
 D630,630 S 1/2011 Andre et al.
 D633,090 S 2/2011 Andre et al.
 D633,091 S 2/2011 Andre et al.
 D633,092 S 2/2011 Andre et al.
 D633,493 S 3/2011 Akana et al.
 D633,908 S 3/2011 Akana et al.
 D634,319 S 3/2011 Andre et al.
 D634,742 S 3/2011 Andre et al.
 D635,540 S 4/2011 Kim et al.
 D635,952 S 4/2011 Park et al.

D636,390 S 4/2011 Andre et al.
 D636,392 S 4/2011 Akana et al.
 D636,769 S 4/2011 Wood et al.
 D637,596 S 5/2011 Akana et al.
 D638,815 S 5/2011 Lee et al.
 D638,835 S 5/2011 Akana et al.
 D642,563 S 8/2011 Akana et al.
 D644,218 S 8/2011 Akana et al.
 D645,017 S 9/2011 Kim et al.
 D645,435 S 9/2011 Kim et al.
 D645,835 S 9/2011 Lee et al.
 D646,249 S 10/2011 Kim et al.
 D646,252 S 10/2011 Kim et al.
 D648,693 S 11/2011 Kim et al.
 D651,189 S 12/2011 Tsai et al.
 8,081,886 B2 12/2011 Okano
 D652,812 S 1/2012 Kim
 D652,813 S 1/2012 Song et al.
 D653,230 S 1/2012 Kim et al.
 D653,642 S 2/2012 Han
 D653,645 S 2/2012 Park
 D654,041 S 2/2012 Jung et al.
 D654,049 S 2/2012 Chung
 D654,460 S 2/2012 Kim et al.
 D654,461 S 2/2012 Kim et al.
 D654,463 S 2/2012 Han
 D654,889 S 2/2012 Kim et al.
 D654,890 S 2/2012 Jung et al.
 D654,891 S 2/2012 Kim et al.
 D654,894 S 2/2012 Kim
 D654,898 S 2/2012 Kim
 D654,899 S 2/2012 Jung
 D654,900 S 2/2012 Jung
 D669,071 S 10/2012 Akana et al.
 D672,343 S 12/2012 Akana et al.
 D678,262 S 3/2013 Prato
 2003/0125079 A1 7/2003 Park et al.
 2003/0125094 A1 7/2003 Hyun et al.
 2003/0125959 A1 7/2003 Palmquist
 2003/0184525 A1 10/2003 Tsai
 2003/0206202 A1 11/2003 Moriya
 2004/0021676 A1 2/2004 Chen et al.
 2004/0041504 A1 3/2004 Ozolins et al.
 2004/0132499 A1 7/2004 Abe
 2004/0155888 A1 8/2004 Padgitt et al.
 2004/0166907 A1 8/2004 Yajima
 2004/0223004 A1 11/2004 Lincke et al.
 2004/0242288 A1 12/2004 Balle et al.
 2004/0257334 A1 12/2004 Yajima
 2005/0009556 A1 1/2005 Hickey et al.
 2005/0012723 A1 1/2005 Pallakoff
 2005/0014538 A1 1/2005 Hyun et al.
 2005/0041385 A1 2/2005 Kikinis et al.
 2005/0059438 A1 3/2005 Jellicoe
 2005/0088418 A1 4/2005 Nguyen
 2005/0127158 A1 6/2005 Figueras et al.
 2005/0130715 A1 6/2005 Fujisawa
 2005/0195154 A1 9/2005 Robbins et al.
 2005/0255897 A1 11/2005 Lee et al.
 2006/0025184 A1 2/2006 Cho et al.
 2006/0025218 A1 2/2006 Hotta
 2006/0094464 A1 5/2006 Kyou et al.
 2006/0111158 A1 5/2006 Hou
 2006/0111161 A1 5/2006 Cha et al.
 2006/0121852 A1 6/2006 Kim et al.
 2006/0142073 A1 6/2006 Gordecki
 2006/0166713 A1 7/2006 Yeh et al.
 2006/0281501 A1 12/2006 Zuo et al.
 2007/0082718 A1 4/2007 Yoon et al.
 2008/0004083 A1 1/2008 Ohki et al.
 2008/0004085 A1 1/2008 Jung et al.
 2009/0247244 A1 10/2009 Mittleman et al.
 2010/0105452 A1 4/2010 Shin et al.

FOREIGN PATENT DOCUMENTS

CA 101263 1/2004
 CN 30-0721986 12/2007
 CN 300721990 12/2007

(56)

References Cited

FOREIGN PATENT DOCUMENTS		
CN	300732852	1/2008
CN	300732857	1/2008
CN	300781645	5/2008
CN	300881212	2/2009
CN	300912552	4/2009
CN	300912572	4/2009
EM	000048061-0001	8/2003
EM	000046198-0001	11/2003
EM	000257621-0004	2/2005
EM	000317490-0001	5/2005
EM	000375191-0001	9/2005
EM	000493721-0002	5/2006
EM	000569157-0005	9/2006
EM	000569157-0007	9/2006
EM	000590831-0001	10/2006
EM	000590831-0003	10/2006
EM	000632070-0007	1/2007
EM	000666789-0001	3/2007
EM	000718770-0007	6/2007
EM	000748256-0003	8/2007
EM	000748280-0001	8/2007
EM	000748280-0004	8/2007
EM	000748280-0006	8/2007
EM	000748322-0001	8/2007
EM	000767959-0001	8/2007
EM	000748314-0001	10/2007
EM	000784780-0001	10/2007
EM	000874466-0012	3/2008
EM	000910591-0001	4/2008
EM	000888920-0001	5/2008
EM	000888920-0018	5/2008
EM	000938071-0001	6/2008
EM	000939731-0001	6/2008
EM	000977822-0006	8/2008
EM	001016802-0001	1/2009
EM	001098149-0001	4/2009
EM	001098149-0007	4/2009
EM	001183461-0002	1/2010
EM	001668781-0001	2/2010
EM	001694712-0001	4/2010
EM	001908534-0001 A1	9/2011
ES	D0505712-01	4/2008
FI	4897	7/1980
FR	990052-001	5/1999
GB	1042780	12/1986
GB	2030050	7/1993
GB	2033245	8/1993
GB	2062780	4/1997
GB	3010002	2/2003
GB	3012502	6/2003
GB	3014024	10/2003
GB	3022447	10/2005
JP	61-69284	4/1986
JP	64-9317	1/1989
JP	000921403	3/1995
JP	001009317	5/1998
JP	2000-163031	6/2000
JP	D1104685	3/2001
JP	D1124750	10/2001
JP	D1142127	5/2002
JP	D1159881	12/2002
JP	D1178470	7/2003
JP	D1188041	10/2003
JP	D1204221	5/2004
JP	2004-290256	10/2004
JP	D1235888	4/2005
JP	D1241383	6/2005
JP	D1241638	6/2005
JP	D1247215	8/2005
JP	D1250487	9/2005
JP	D1263649	2/2006
JP	1280315	9/2006
JP	D1285057	10/2006
JP	000614565-0001	12/2006
JP	D1295003	2/2007

JP	D1302929	6/2007
KR	30-0304213	8/2002
KR	30-0327126	6/2003
KR	30-0359572	8/2004
KR	30-0360712	9/2004
KR	30-0364027	10/2004
KR	30-0364845	10/2004
KR	30-0367347	11/2004
KR	30-0367787	11/2004
KR	30-0370833	1/2005
KR	30-0376524	3/2005
KR	30-0387059-3	7/2005
KR	30-0387130	7/2005
KR	30-0387648	7/2005
KR	30-0396917	11/2005
KR	30-0398307	11/2005
KR	30-0394921-1	12/2005
KR	30-0418422-1	7/2006
KR	30-0418547	7/2006
KR	30-0420200	7/2006
KR	30-0422221	8/2006
KR	30-0424148	9/2006
KR	30-441230	2/2007
KR	30-0441230-1	2/2007
KR	30-0452432	6/2007
KR	30-0454592	7/2007
KR	30-0441230-2	8/2007
KR	30-0441230-3	8/2007
KR	30-0452985-2	8/2007
KR	30-0467088	10/2007
KR	30-0474260	12/2007
KR	30-0529167	5/2009
KR	30-0533504	7/2009
KR	30-0546031	11/2009
KR	30-0550428	1/2010
KR	30-0553546	2/2010
RU	71776 S	8/2009
RU	78149 S	4/2011
SE	55044	10/1993
TW	D106137	8/2005
TW	D123283	6/2008
TW	D126454	12/2008
TW	D126838	1/2009
TW	D126996	4/2009
TW	D126997	4/2009
TW	D129176	6/2009
TW	D131556	10/2009
TW	D132490	12/2009
TW	D139493	3/2011
TW	D147938 S	7/2012
WO	WO 00/74240	7/2000
WO	WO 01/88679 A2	11/2001
WO	WO 2004/023272	3/2004

OTHER PUBLICATIONS

Blogitech.co.uk, "Sharp WX-T825 (Softbank 825SH) arrives Taiwan," (<http://blogitechnews.blogspot.co.uk/2008/10/sharp-wx-t825-softbank-825sh-arrives.html>), published Oct. 3, 2008, 2 pages.

Chan, Meng, "LG BL40 Chocolate," MassOrder Mobile Tech Blog, (<http://massordermobile.blogspot.co.uk/2009/11/lg-b140-new-chocolate.html>), published Nov. 17, 2009, 7 pages.

Har-Even, Benny, "iRiver U10 media player," The Register, (http://www.theregister.co.uk/2006/01/19/review_iriver_u10/print.html), published Jan. 19, 2006, 5 pages.

Justia, "*Apple v. Samsung Electronics Co. Ltd. et al.*, Filing: 943 Attachment 5," (<http://docs.justia.com/cases/federal/district-courts/california/candce/5:2011cv01846/239768/943/5.html>), dated May 18, 2012, 3 pages.

Lee, Tommy, "Cookie phone pink, LG Electronics Cyon LG-LU9100," (<http://diner.tistory.com/m/post/view/id/211>), published Jul. 14, 2009, 8 pages.

Mobilegazette.com, "Acer DX900 / E-TEN Glofiish DX900," (<http://www.mobilegazette.com/acer-dx900-09x02x04.html>), published Feb. 4, 2009, 3 pages.

Mobilegazette.com, Apple iPhone 3G, (<http://www.mobilegazette.com/apple-iphone-3g-08x06x09.htm>), published Jun. 9, 2008, 5 pages.

(56)

References Cited

OTHER PUBLICATIONS

- Mobilegazette.com, "E-TEN Glofish X650," (<http://www.mobilegazette.com/eten-glofish-x650-08x01x12.htm>), published Jan. 12, 2008, 2 pages.
- Mohindru, Ravin, "New iPod touch 4G (4th gen) First Impressions," TouchReviews.net, (<http://touchreviews.net/ipod-touch-4g-4-impressions/>), published Sep. 7, 2010, 10 pages.
- Support.Apple.com, "Identifying iPhone Models," (<http://web.archive.org/web/20121211214303/http://support.apple.com/kb/HT3939>), last modified Oct. 30, 2012, 5 pages.
- Support.Apple.com, "Identifying iPod Models," (<http://web.archive.org/web/20121024182303/http://support.apple.com/kb/HT1353>), last modified Apr. 6, 2012, 16 pages.
- "A Day in the Life of InfoLink," Stanford University Libraries, published May 1, 2003.
- "The Oracle: The Personal Computer of the Year 2000," Stanford University Libraries.
- "The Organizer: The Personal Computer of the Year 2000," Stanford University Libraries.
- "Toshiba Dynapad T100X Pen Computer," product available in 1993, 2 pages.
- ABDI, "Five 1 GB Flash MP3 Players," Tomsguide.com, (<http://www.tomsguide.com/corillus/five-1gb-flash-mp3-players,review-722-3.html>), published May 30, 2006, 4 pages.
- Aliexpress.com, "WACOM PL-500 15" LCD Tablet Mint," (<http://www.aliexpress.com/product-fm/430172068-WACOM-PL-500-15-LCD-Tablet-Mint-Worldwide-Free-Shipping-wholesalers.html>), accessed Nov. 14, 2011, 3 pages.
- Amazon, "Developing Tablet PC Applications—(Charles River Media Programming)," (<http://www.amazon.co.uk/Developing-Tablet-Applications-Charles-Programming/dp/1584502525>), retrieved Jul. 20, 2011, 4 pages.
- Amazon.com, "Digitalway MPIO FL100 128 MB MP3 Player" (<http://www.amazon.com/Digitalway-MPIO-FL100-128-Player/dp/B00008V6NI>), accessed Nov. 17, 2011, 7 pages.
- Amazon.com, "Whirlpool Gold : GH7208XRS 2.0 cu. ft. Velos Speedcook Over the Range Microwave Oven," (<http://www.amazon.com/Whirlpool-Gold-GH7208XRS-Speedcook-Microwave/dp/B000ZIPM8>), accessed May 23, 2012, 5 pages.
- AndroidTabletFanatic.com "16 Old-Skool Tablets Rocking it Before the iPad," (<http://www.androidtabletfanatic.com/android-tablet-news/16-old-skool-tablets-rocking-it-before-the-ipad/>), published May 16, 2011, 10 pages.
- Apple Inc., "Apple Introduces the U2 iPod," (<http://www.apple.com/pr/library/2004/10/26Apple-Introduces-the-U2-iPod.html>), published Oct. 26, 2004, 2 pages.
- Association for Computing Machinery, The Open Video Project, "ACM CHI 1995—The Tablet Newspaper: A vision for the Future," (<http://www.open-video.org/details.php?videoid=83158zsurrogate=storyboard>), 3 pages (1994).
- Aumente, J., American Journalism Review, "Panel Vision," (<http://www.ajr.org/Article.asp?id=1257>), published Oct. 1994, 7 pages.
- Blandford, "Nokia N92 Preview," (http://www.allaboutsymbian.com/features/item/Nokia_N92_Preview.php), published Nov. 23, 2005, 10 pages.
- Blickenstorfer, C., PenComputing Magazine, "Tablet PCs: HP Compaq Tablet PC TC1000," (http://pencomputing.com/frames/tpc_compaq.html), 3 pages (Dec. 2002).
- Blickenstorfer, C., PenComputing Magazine, "Tablet PCs: Motion Computing M1200," (http://pencomputing.com/frames/tpc_motion1200.html), 3 pages (Dec. 2002).
- Blickenstorfer, C., PenComputing Magazine, "Tablet PCs: ViewSonic V1100," (http://pencomputing.com/frames/tpc_viewsonic.html), 3 pages (Dec. 2002).
- Block, "Olympus @ CES Hands-on with the m:robe MR-500i and MR-100," Engadget.com, (<http://www.engadget.com/2005/01/10/olympus-ces-hands-on-with-the-m-robe-mr-500i-and-mr-100>), published Jan. 10, 2005, 3 pages.
- Cell Phones.About.com, "More pictures of the LG KG800," (http://cellphones.about.com/library/bl-pi-lg_kg800.htm), accessed Feb. 13, 2012, 1 page.
- Chi-atheneum, "Good Design 2003, An International Industrial and Graphic Design Competition," (<http://www.chi-atheneum.org/gdesign/winners03.htm>), retrieved Sep. 23, 2011, 7 pages.
- Chip Online, "VIA: Zwitter-PC für Schöngeste," (http://www.chip.de/news/VIA-Zwitter-PC-fuer-Schoengeister_34204096.html), Published May 8, 2002, 2 pages.
- Clarke, "Newspad by Authur C. Clarke from 2001: A Space Odyssey," (<http://www.technovelgy.com/ct/content.asp?Bnum=529>), published 1968, 3 pages.
- Computex.biz, "Tatung Tablet PC," (http://www.computex.biz/tatung/Default.aspx?pagetype=ProductDetail&pdt_id=36&cid=3...), accessed Nov. 4, 2011, 3 pages.
- Computing History, "GRidPad 1910," (<http://computinghistory.org.uk/det/6565/GRidPad-1910>), retrieved Sep. 12, 2011, 2 pages.
- dcinside.com, "iHolic HTV-200" (<http://dica.dcinside.com/review.php?pid=7192>), retrieved Sep. 22, 2011, 16 pages.
- Dial-a-Phone.co.uk, "Samsung F700 beats the iPhone!" (<http://blog.dialaphone.co.uk/2007/02/16/samsung-t700-beats-the-iphone/>), published Feb. 16, 2007, 38 pages.
- DigiBarn Systems, "GRiDpad Pen Computer," (<http://www.digibarn.com/collections/systems/gridpad/index.html>), retrieved Sep. 23, 2011, 2 pages.
- EdibleApple, "The first Apple Tablet . . . from 1979," (<http://www.edibleapple.com/the-first-apple-tablet-from-1979/>), published Nov. 23, 2009, 8 pages.
- eFashion Magazine, vol. 119, p. 45, China (Jun. 1, 2005).
- eFashion Magazine, vol. 12, p. 60, China (2004).
- eFashion Magazine, vol. 172, p. 26, China (Apr. 2006).
- Electronista, "LG/Prada phone revealed?," (<http://www.electronista.com/articles/06/12/20/lg.prada.phone.revealed/>), updated Dec. 20, 2006, 9 pages.
- EngineerBoy, CleverDonkey.com, "2001:A Space Odyssey and the iPad (or is it tamPod?)," (<http://www.cleverdonkey.com/1499-2001a-space-odyssey-and-the-ipad-or-is-it-tampod/>), published Feb. 2, 2010, 5 pages.
- Flickr.com, "Apple Graphics Tablet" (http://farm3.static.flickr.com/2691/4126733086_b24c987b0e_o.jpg), accessed Nov. 15, 2011, 1 page.
- Fried, "Live-blogging Steve Ballmer," CNET, (http://www.cnet.com/8301-31045_1-10426723-269.html?tag=mncol%3btxt), published Jan. 6, 2010, 6 pages.
- GSMarena.com, "Apple iPhone," (http://www.gsmarena.com/apple_iphone-1827.php), accessed Mar. 12, 2007, 3 pages.
- GSMarena.com, "LG KE850 Prada," (http://www.gsmarena.com/lg_ke850_prada-1828.php), accessed Feb. 20, 2007, 4 pages.
- GSMarena.com, "Phillips S900," (http://www.gsmarena.com/philips_s900-1598.php), accessed Feb. 20, 2007, 2 pages.
- GSMarena.com, "Samsung F700," (http://www.gsmarena.com/samsung_f700-1849.php), accessed Feb. 8, 2007, 2 pages.
- Hagen, R., GadgetZone, "iHolic portable mediaspeler," (<http://www.gadgetzone.nl/nieuws.php?id=3191>), published Jan. 4, 2007, 3 pages.
- Hilon.com, "LG DMB MP3 FM35" (<http://www.hilon.com.cn/autobak/a88100055479.htm>), accessed Dec. 26, 2008, 18 pages.
- iF Design, "iF product design award 2007," (http://www.ifdesign.de/beitragsdetails_e.html?offset=87&sprache=2&award_id=121&Beit...), accessed on Sep. 21, 2011, 1 page.
- iriver.com, "iriver U-10," (www.iriver.com), published 2005, 2 pages.
- Itbusiness.ca, "Microsoft Mira eHome Wireless Smart Display," (http://www.itbusiness.ca/images/articles/Jun10/clip_image003_0087.jpg), accessed Nov. 15, 2011, 1 page.
- iTechNews.net, "Samsung K3 MP3 Player," (<http://www.itechnews.net/2006/12/02/samsung-k3-mp3-player/>), published Dec. 2, 2006, 9 pages.
- Justia, "Apple v. Samsung Electronics Co. Ltd. et al., Filing: 943 Attachment: 5," (<http://docs.justia.com/cases/federal/district-courts/california/candce/5:2011cv01846/239768/943/5.html>), dated May 18, 2012, 3 pages.

(56)

References Cited

OTHER PUBLICATIONS

- Kauffmann, "Music That Fits In Your Pocket," Tomsguide.com, (<http://www.tomsguide.com/us/music-that-fits-in-your-pocket,review-525-5.html>), published Aug. 25, 2005, 4 pages.
- Knowyourmobile.com, "LG KG800 technical specifications," (http://www.knowyourmobile.com/lg/lgkg800chocolate/lgkg800reviews/137/lg_kg800_technical_specifications.html), published Mar. 9, 2007, 3 pages.
- Lugmayr, "Sexy iHolic DMB TV PMP," (<http://www.i4u.com/11656/scxy-iholicdmb-tv-pmp>), published Jan. 3, 2007, 1 page.
- Martin, T., "The Tablet Newspaper: A Vision for the Future," Human Factors in Computing Systems, Chi '95 Conference Companion, pp. 425, Colorado, United States (May 1995).
- McCracken, "The iPad. Of 2000. As Envisioned in 1988," Technologizer.com, (<http://technologizer.com/2010/05/14/the-ipad-of-2000-as-envisioned-in-1988/>), published May 14, 2010, 12 pages.
- Mel et al., "Tablet: Personal Computer in the Year 2000," *Communications of the ACM* 31:638-646, ACM (Jun. 1988).
- Mobilegazette.com, "Nokia N92," (<http://www.mobilegazette.com/nokia-n92-051102.htm>), published Nov. 2, 2005, 2 pages.
- Mobilewhack.com, "Tinnos PDA," (http://www.mobilewhack.com/reviews/tinnos_pda.html), published May 19, 2006, 1 page.
- Needleman, "Hands-on with the JooJoo," (http://news.cnet.com/8301-19882_3-10410960-250.html), CNET News, published Dec. 7, 2009, 31 pages.
- NewLaunches, "LG Prada cell phones are truly iconic," (http://www.newlaunches.com/archives/lg_prada_cell_phones_are_truly_iconic.php), retrieved Sep. 12, 2011, 3 pages.
- NewLaunches, "LG Wears Prada," (http://www.newlaunches.com/archives/lg_wears_prada.php), retrieved Sep. 23, 2011, 2 pages.
- NewLaunches.com, "Pidion BM-200 sleek Windows CE PDA phone from Bluebird," (http://www.newlaunches.com/archives/pidion_bm200_sleek_windows_ce_pda_phone_from_bluebird.php), published Dec. 15, 2005, 3 pages.
- NYTimes.com, "iRiver U10 (1GB)," (<http://www.nytimes.com/technology/personaltech/music-players/iRiver-U10-1GB/31432102.html>), published Feb. 12, 2012, 2 pages.
- NYTimes.com, "iRiver U10 (1GB)," (<http://www.nytimes.com/technology/personaltech/music-players/iRiver-U10-1GB/31432102.html>), published Feb. 12, 2012, 2 pages.
- Patel, "The HP Slate" (<http://www.engadget.com/2010/01/06/the-hp-slate/>), Engadget.com, published Jan. 6, 2010, 4 pages.
- PC Magazine, "HP Compaq Tablet PC TC1000," (<http://www.pcmag.com/article2/0,2817%20,939500,00.asp>), published Apr. 8, 2003, 3 pages.
- PCMag.com, "iriver U10," (<http://www.pcmag.com/article2/0,2817,1901833,00.asp>), published Dec. 14, 2005, 3 pages.
- PDADB.net, "Bluebird Pidion BM-200 Specs," (http://pdadb.net/index.php?m=specs&id=1804&c=bluebird_pidion_bm-200), published Mar. 24, 2008, 3 pages.
- PDADB.net, "Casio Cassiopeia IT-10 M20BR Specs," (http://pdadb.net/index.php?m=specs&id=95&c=casio_cassiopeia_it-10_m20br), published Dec. 30, 2004, 3 pages.
- PDADB.net, "CyberBank POZ X301 Specs," (http://pdadb.net/index.php?m=specs&id=442&c=cyberbank_poz_x301), published Jan. 31, 2006, 3 pages.
- PDADB.net, "Dell Axim X3 Basic Specs," (http://pdadb.net/index.php?m=specs&id=81&c=dell_axim_x3_basic), published Dec. 30, 2004, 3 pages.
- PDADB.net, "Detailed Specifications of O2 XDA Flame," (http://pdadb.net/index.php?m=specs&id=673&view=1&c=O2_xda_flame), accessed May 6, 2011, 3 pages.
- PDADB.net, "Dopod 838 Pro (HTC Hermes 100) Specs," (http://pdadb.net/index.php?m=specs&id=578&c=dopod_838_pro_htc_hermes_100), published Aug. 4, 2005, 3 pages.
- PDADB.net, "Garmin iQue M5 Specs," (http://pdadb.net/index.php?m=specs&id=302&c=garmin_ique_m5), published Jul. 17, 2005, 3 pages.
- PDADB.net, "Krome Spy (HTC Magician Refresh) Specs," (http://pdadb.net/index.php?m=specs&id=550&c=krome_spy_htc_magician_refresh), published Jul. 18, 2006, 3 pages.
- PDADB.net, "MiTAC Mio 338 Plus Digi-Walker Specs," (http://pdadb.net/index.php?m=specs&id=60&c=mitac_mio_338_plus_digi-walker), published Dec. 25, 2004, 3 pages.
- PDADB.net, "O2 XDA (HTC Wallaby) Specs," (http://pdadb.net/index.php?m=specs&id=117&c=o2_xda_htc_wallaby), published Feb. 3, 2005, 3 pages.
- PDADB.net, "Palm Z22 Specs," (http://pdadb.net/index.php?m=specs&id=1244&c=palm_z22), published Mar. 13, 2006, 3 pages.
- PDADB.net, "PalmOne LifeDrive Specs," (http://pdadb.net/index.php?m=specs&id=1242&c=palmone_lifedrive), published Mar. 12, 2008, 3 pages.
- PDADB.net, "Sony Clie PEG-SL10 / PEG-SL10U / PEG-SL10E Specs," (http://pdadb.net/index.php?m=specs&id=1198&c=sony_clie_peg-sl10_peg-sl10u_peg-sl10e), published Mar. 4, 2008, 3 pages.
- PDADB.net, "Sony Clie PEG-T665C / PEG-T675C Specs," (http://pdadb.net/index.php?m=specs&id=1192&c=sony_clie_peg-t665c_peg-t675c), published Mar. 4, 2008, 3 pages.
- PDADB.net, "Toshiba Genio e330 Specs," (http://pdadb.net/index.php?m=specs&id=29&c=toshiba_genio_e330), published Dec. 9, 2004, 3 pages.
- PDADB.net, "Toshiba Genio e570 Specs," (http://pdadb.net/index.php?m=specs&id=229&c=toshiba_genio_e570), published May 4, 2006, 3 pages.
- Ricker, "LG's KE850 Prada official: iPhone says, wha?" Engadget.com, (<http://www.engadget.com/2007/01/18/lgs-ke850-prada-official-iphone-says-wha/>), published Jan. 18, 2007, 4 pages.
- Ricker, "Meizu's M8? Apple lawyers, start your engines," Engadget.com, (<http://www.engadget.com/2007/01/29/meizus-m8-apple-lawyers-start-your-engines/>), published Jan. 29, 2007, 1 page.
- Ricker, "The Pidion BM-200: it's time to move to Seoul," (<http://www.engadget.com/2005/10/04/the-pidion-bm-200-its-time-to-move-to-seoul/>), Engadget.com, published Oct. 4, 2005, 4 pages.
- Rojas, "Hands-on with the Nokia N92," Engadget.com, (<http://www.engadget.com/2005/12/01/hands-on-with-the-nokia-n92/>), published Dec. 1, 2005, 4 pages.
- S., Dimitris, "Pidion BM200 Smartphone," PDASNews, (www.pdasnews.com/articles/pidion-bm200-smartphone.html), published 2009, 2 pages.
- Salestores.com, "LG L1530TM Tablet LCD Monitor," (<http://salestores.com/lgl1530tm.html>), accessed Nov. 17, 2011, 2 pages.
- Samsung, "Samsung F700 is razendsnelle alleskunner voor mobiel breedband van Vodafone," (http://www.samsung.com/nl/mobile/pressView.do?ptype=press&page13&news_seq=22544), published May 25, 2008, 2 pages.
- Samsung, "Samsung Unveils Revolutionary Ultra Smart F700," (http://www.samsung.com/us/news/newsRead.do?news_seq=3516), published Nov. 23, 2009, 2 pages.
- Smith et al., "The Radial Scroll Tool: Scrolling Support for Stylus- or Touch-Based Document Navigation," *UIST*, ACM, published Oct. 2004.
- Smith, reghardware.com, "First fondleslab found in 1970s kids TC sci-fi gem: Apple iPad inspired by Tomorrow People," (http://www.reghardware.com/2011/02/07/apple_ipad_tomorrow_people/), published Feb. 7, 2011, 3 pages.
- Sooman, "The LG Chocolate phone," Techspot.com, (<http://www.techspot.com/news/20929-the-lg-chocolate-phone.html>), published on Mar. 23, 2006, 5 pages.
- Van Reeth, J., "Vantage is showing its colours!," *Home automation journal* 11:1-8, Vantage Emea, Belgium (Jun. 2003).
- Vasile, C., Softpedia, "MobilePen: An Expensive but Helpful Touchscreen," (<http://news.softpedia.com/news/MobilePen-An-Expensive-But-Helpful-Touchscreen-16192.shtml>), published Jan. 12, 2006, 2 pages.
- Vilas-Boas, "Industrial Design Portfolio," (<http://rdvb-designshowcase.blogspot.com/p/cheddar-1-2009.html>), published 2004, 6 pages.

(56)

References Cited

OTHER PUBLICATIONS

WebdesignerDepot.com, "The Evolution of Cell Phone Design Between 1983-2009" (<http://www.webdesignerdepot.com/2009/05/the-evolution-of-cell-phone-design-between-1983-2009/>), accessed May 6, 2011, 56 pages.

Wikipedia, "Etch A Sketch," (http://en.wikipedia.org/wiki/Etch_a_sketch), last modified Aug. 24, 2011, 4 pages.

Wikipedia, "MessagePad," (<http://en.wikipedia.org/wiki/Messagepad>), retrieved Sep. 12, 2011, 10 pages.

Wikipedia.org, "CLIE," (<http://en.wikipedia.org/wiki/CLIE>), last modified Feb. 12, 2011, 3 pages.

Wikipedia.org, "E-Ten" (<http://en.wikipedia.org/wiki/E-TEN>), last modified Dec. 15, 2010, 2 pages.

Wikipedia.org, "File:LG KE850 Prada Hauptmenü.jpg," (http://en.wikipedia.org/wiki/File:LG_KE850_Prada_Hauptmen%C3%BC.jpg), published May 13, 2008, 4 pages.

Wikipedia.org, "iPAQ" (<http://en.wikipedia.org/wiki/IPAQ>), last modified May 4, 2011, 7 pages.

Wikipedia.org, "LifeDrive" (<http://en.wikipedia.org/wiki/LifeDrive>), last modified Mar. 16, 2011, 3 pages.

Wikipedia.org, "Pocket viewer," (http://en.wikipedia.org/wiki/Pocket_viewer), last modified Apr. 10, 2011, 4 pages.

Wikipedia.org, "Zire Handheld" (http://en.wikipedia.org/wiki/Zire_Handheld), last modified Dec. 11, 2010, 4 pages.

ZDNet, "Viewsonic V1100," (<http://www.zdnet.nl/reviews/24712/viewsonic-v1100/>), published Feb. 17, 2003, 9 pages.

Ziegler, "The LG KE850: touchable chocolate," Engadget.com, (<http://www.engadget.com/2006/12/15/the-lg-ke850-touchable-chocolate/>), published Dec. 15, 2006, 5 pages.

Amazon, "Sharp Zaurus S1-6000L Handheld," (<http://www.amazon.com/Sharp-SL6000L-Zaurus-Handheld/dp/B0001W17H2>), product available Mar. 12, 2004, 5 pages.

Coby Communications Ltd., Consumer Electronics 2009 Fall, received by the JPO Industrial Property Library on Oct. 23, 2009; 1 page.

GSMarena.com, "Phillips S900," (http://www.gsmarena.com/philips_s900-1598.php), accessed Feb. 20, 2007, 2 pages.

Hamamatsu Toa Electric Co. Ltd., Smartphone BM-170, received by the JPO Industrial Property Library on Mar. 26, 2010; 1 page.

Mobiface, "The Black Box," (<http://www.mobiface.com/view.php?id=53>), published Sep. 28, 2006, 5 pages.

U.S. Appl. No. 29/431,553, "Electronic Device," inventors Akana, et al., filed on Sep. 7, 2012 (Not Published).

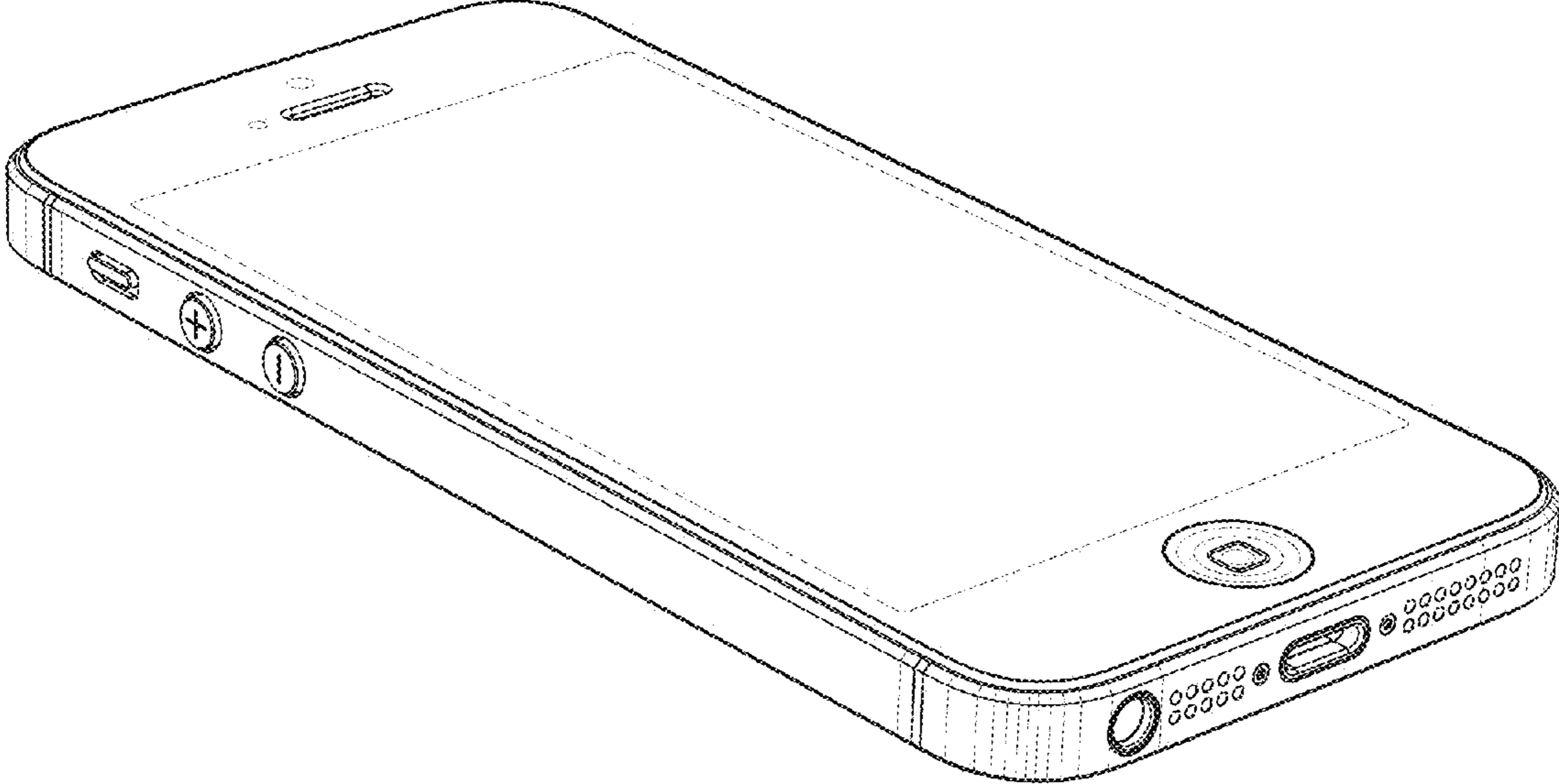

FIG. 1

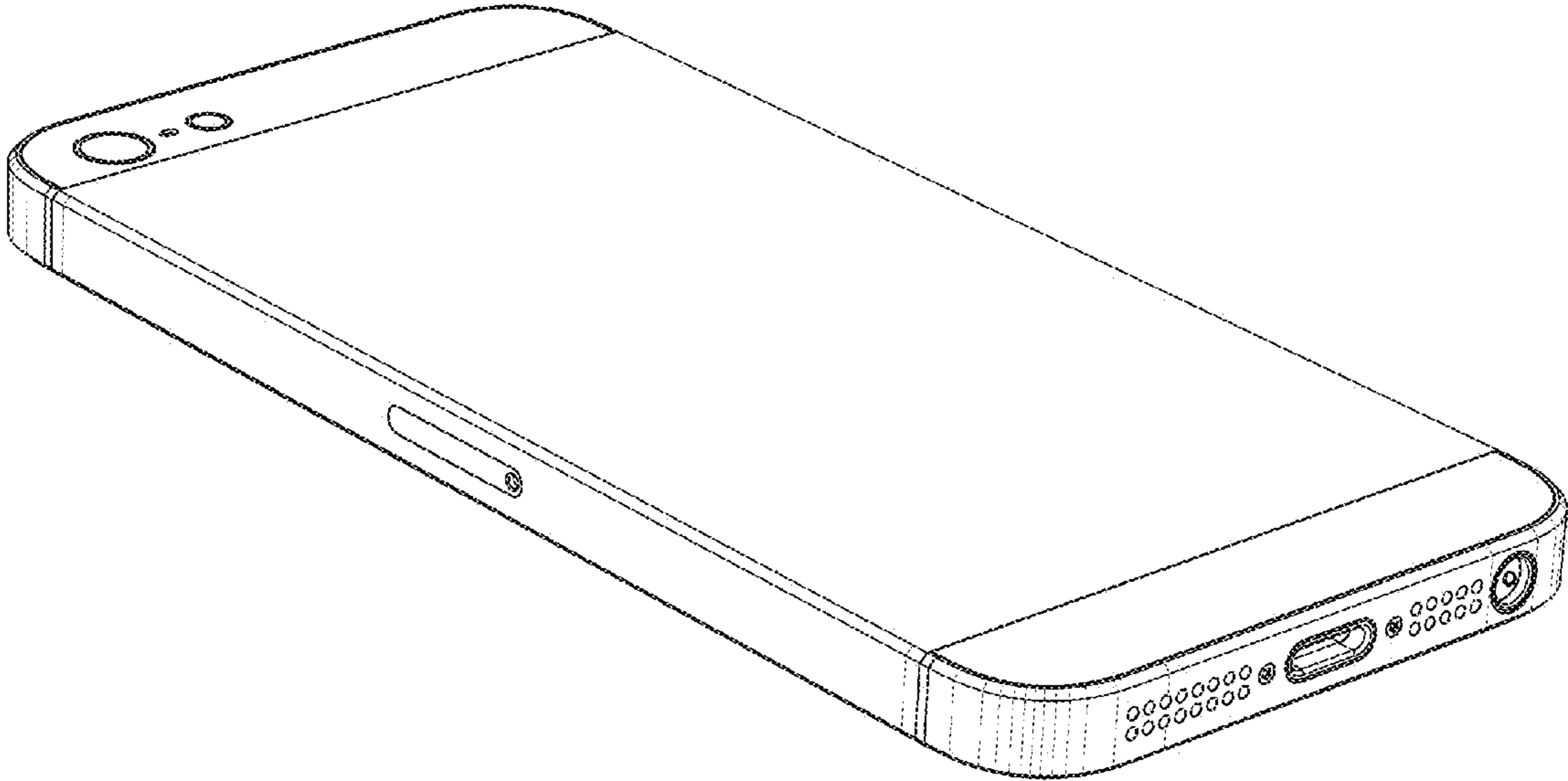

FIG. 2

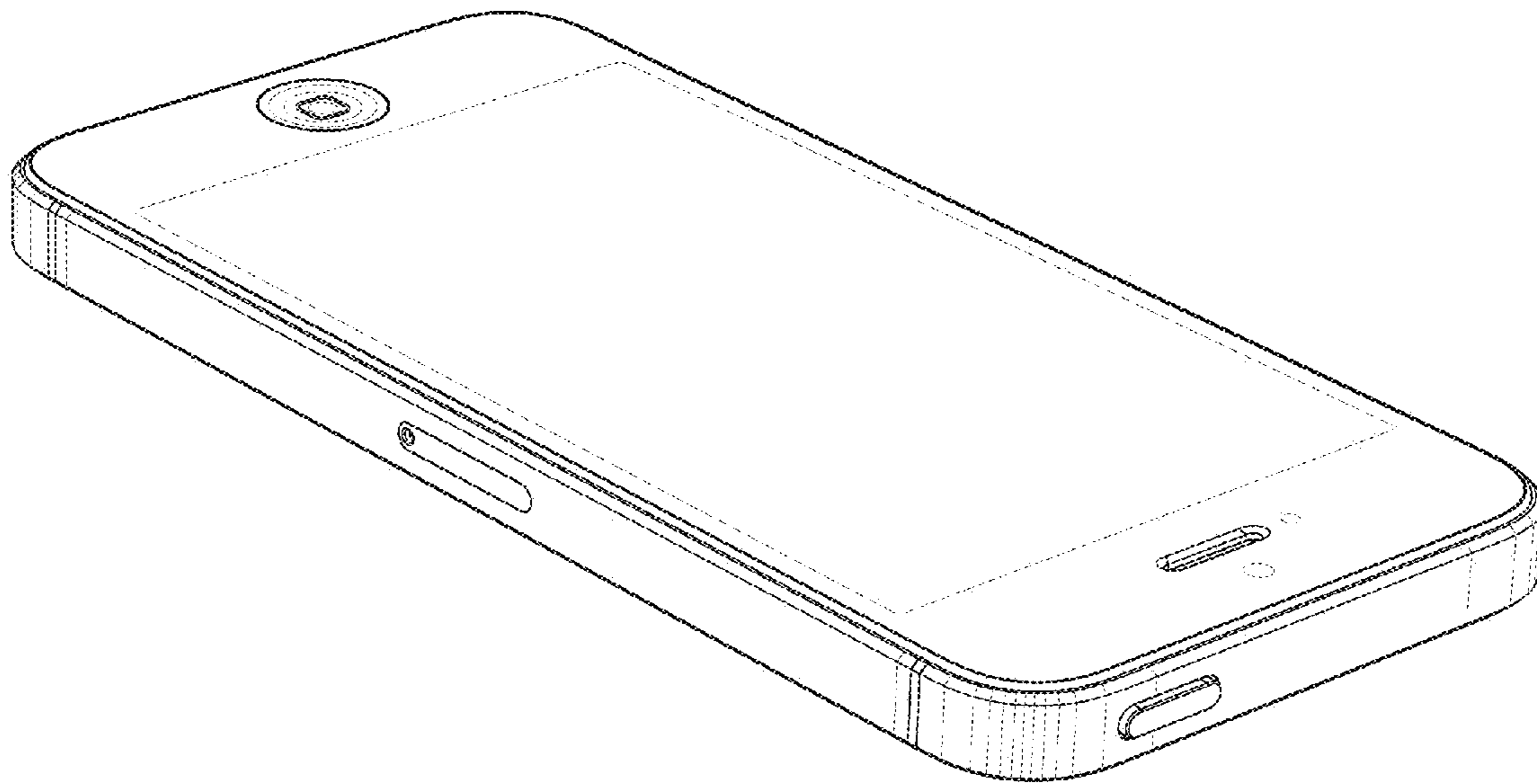

FIG. 3

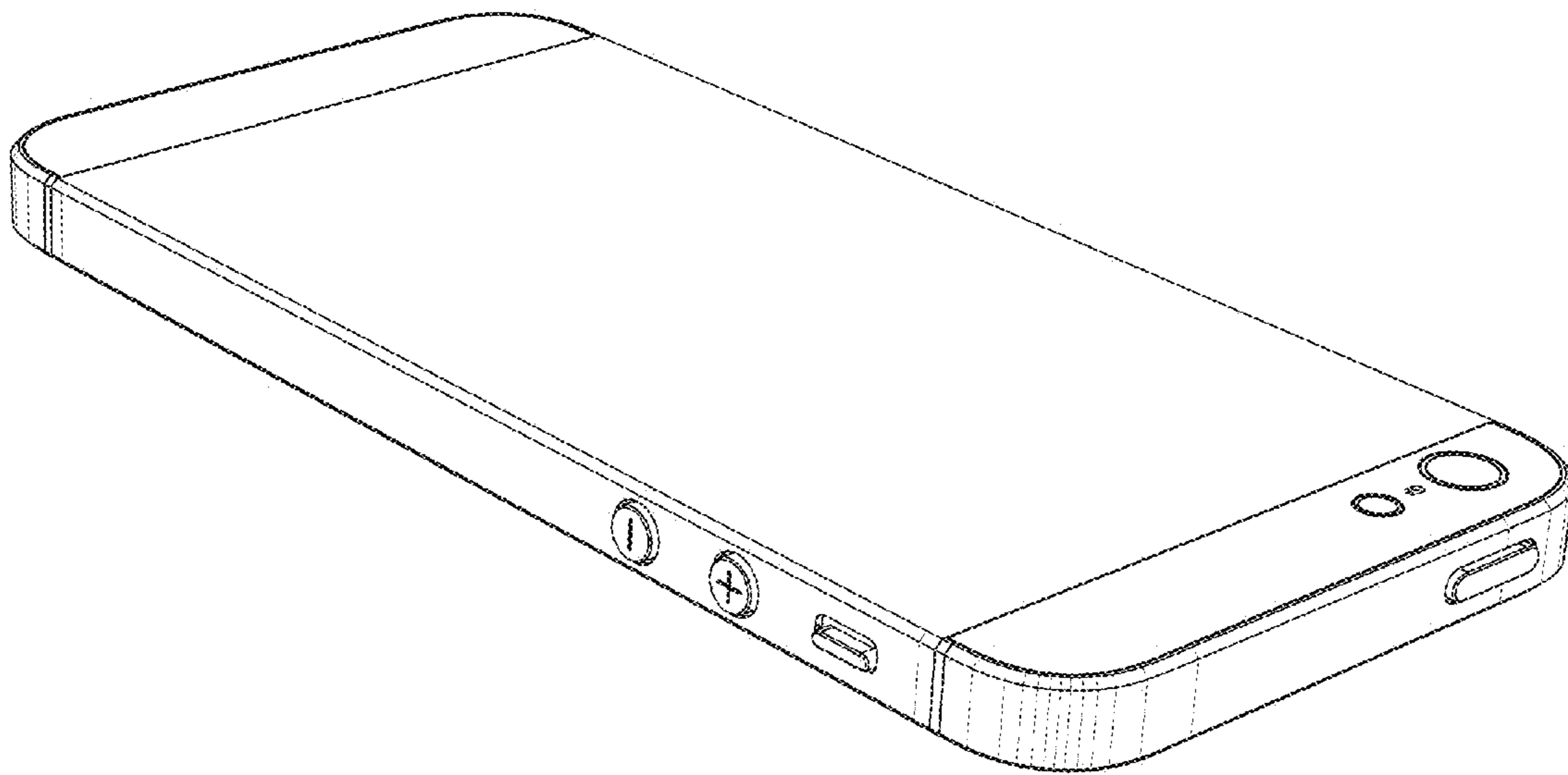

FIG. 4

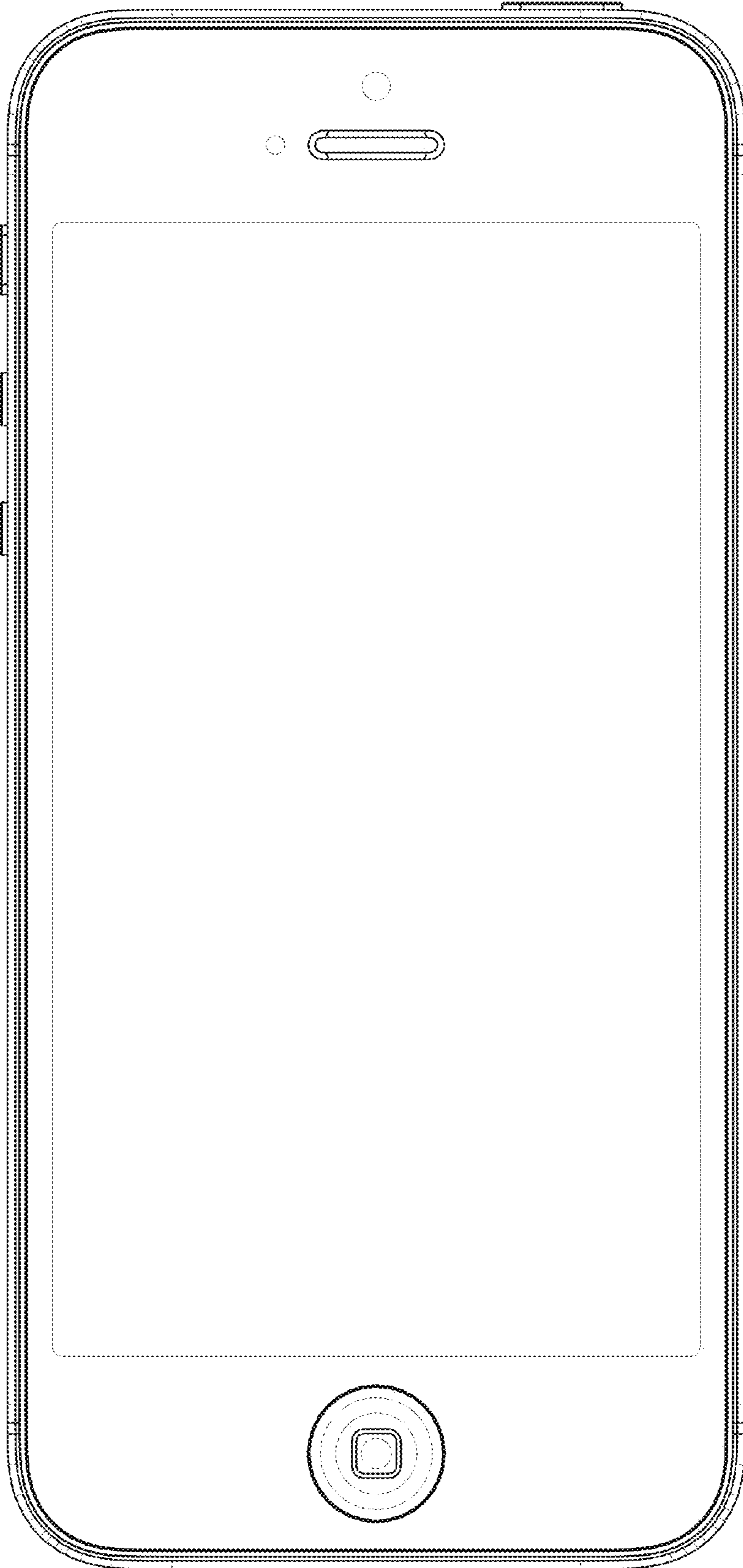

FIG. 5

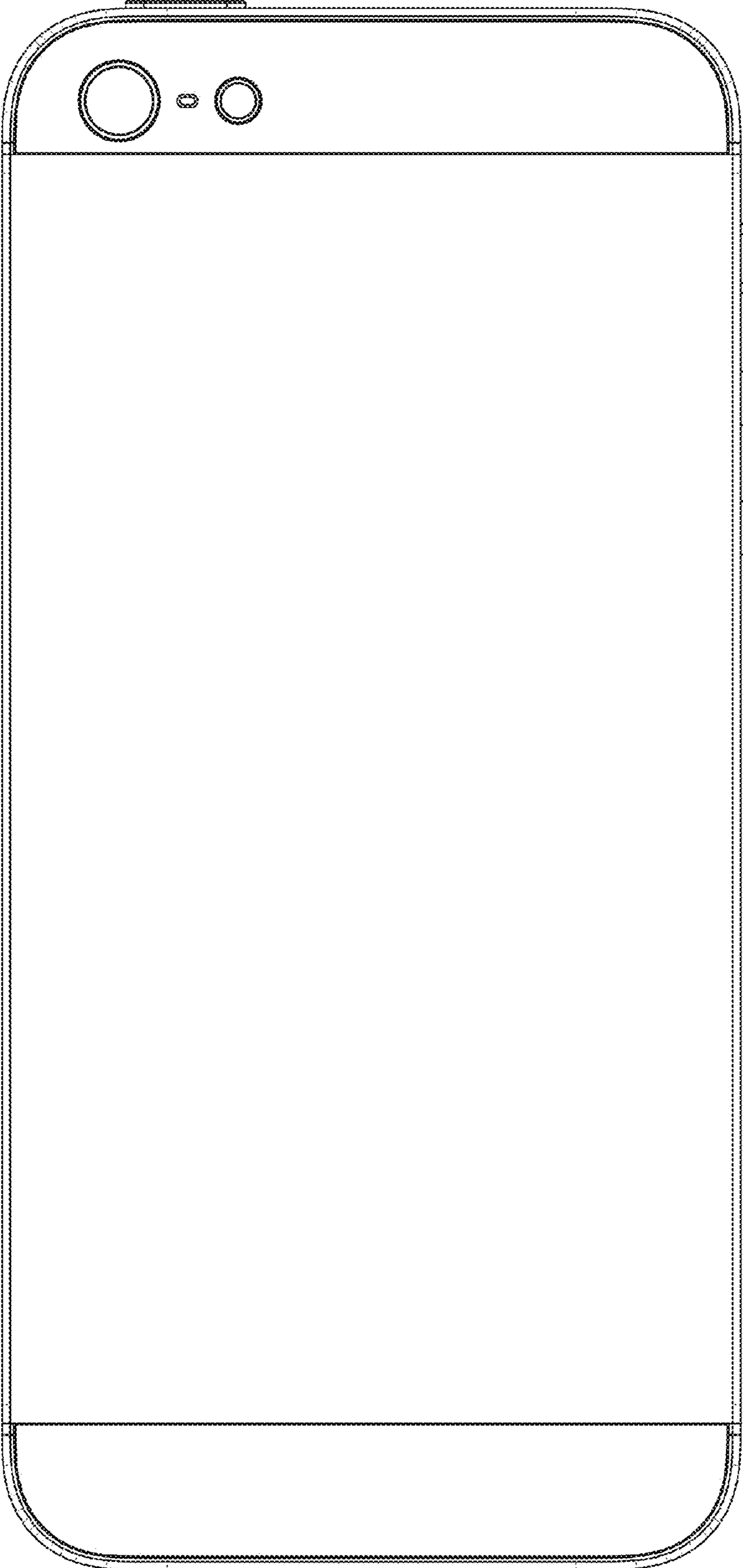

FIG. 6

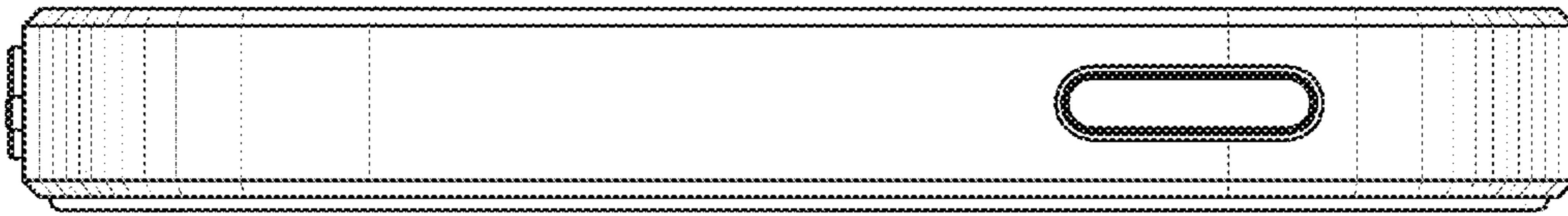

FIG. 7

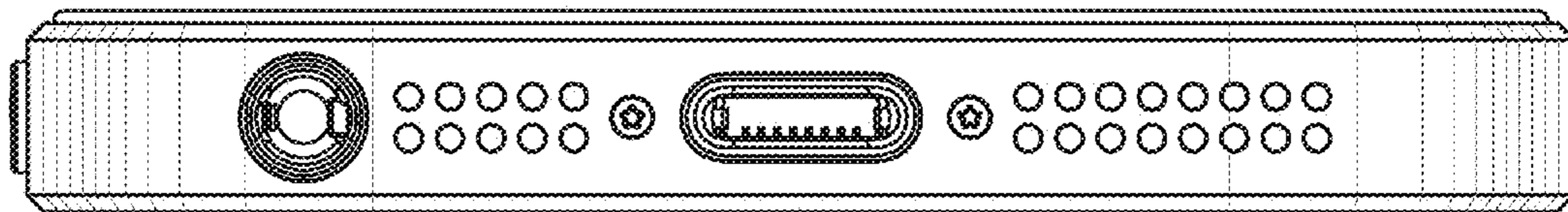

FIG. 8

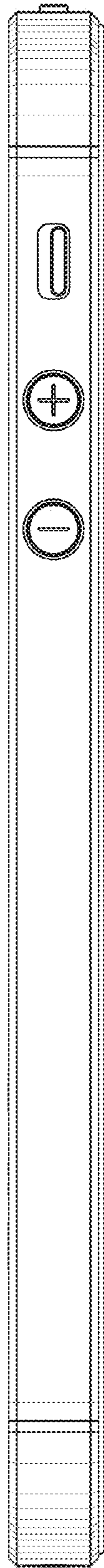

FIG. 9

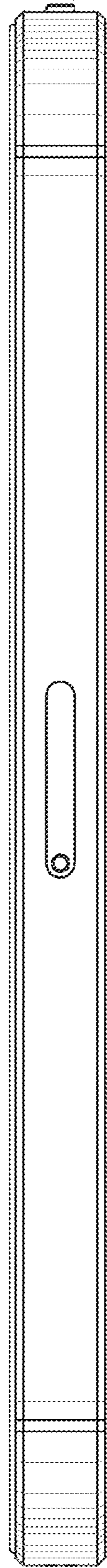

FIG. 10

UNITED STATES PATENT AND TRADEMARK OFFICE
CERTIFICATE OF CORRECTION

PATENT NO. : D707,223 S
APPLICATION NO. : 29/423180
DATED : June 17, 2014
INVENTOR(S) : Jody Akana et al.

Page 1 of 12

It is certified that error appears in the above-identified patent and that said Letters Patent is hereby corrected as shown below:

The title page showing the illustrative figure should be deleted to be replaced with the attached title page.

On the title page, between the "Assignee" and "Term" sections, please add the following language:

--*Notice: This patent is subject to a terminal disclaimer.--

In the Drawings

In the drawing sheets, consisting of Figs. 1-10, should be deleted to be replaced with the drawing sheets, consisting of Figs. 1-10, as shown on the attached pages.

Signed and Sealed this
Second Day of September, 2014



Michelle K. Lee
Deputy Director of the United States Patent and Trademark Office

(12) **United States Design Patent** (10) **Patent No.:** **US D707,223 S**
Akana et al. (45) **Date of Patent:** ** **Jun. 17, 2014**

(54) **ELECTRONIC DEVICE**
 (75) **Inventors:** **Jody Akana**, San Francisco, CA (US); **Bartley K. Andre**, Menlo Park, CA (US); **Jeremy Bataillon**, San Francisco, CA (US); **Daniel J. Coster**, San Francisco, CA (US); **Dantele De Iullis**, San Francisco, CA (US); **M. Evans Hankey**, San Francisco, CA (US); **Julian Hoenig**, San Francisco, CA (US); **Richard P. Howarth**, San Francisco, CA (US); **Jonathan P. Ive**, San Francisco, CA (US); **Duncan Robert Kerr**, San Francisco, CA (US); **Shin Nishibori**, Kailua, HI (US); **Matthew Dean Rohrbach**, San Francisco, CA (US); **Peter Russell-Clarke**, San Francisco, CA (US); **Christopher J. Stringer**, Woodside, CA (US); **Eugene Antony Whang**, San Francisco, CA (US); **Rico Zorkendorfer**, San Francisco, CA (US)

(73) **Assignee:** **Apple Inc.**, Cupertino, CA (US)
 (**) **Term:** **14 Years**
 (21) **Appl. No.:** **29/423,180**
 (22) **Filed:** **May 29, 2012**
 (51) **LOC (10) Cl.** **14-02**
 (52) **U.S. Cl.**
 USPC **D14/341**
 (58) **Field of Classification Search**
 USPC **D14/341-347, 137, 138 AA, 138 R, D14/138 C, 138 G, 496, 203.1, 203.3, 203.7, D14/426, 129, 130, 420, 147, 218, 247-248, D14/389, 388, 315-318, D10/65, 104.1; D18/6-7; D21/324, 329, 330; 455/556.1, 556.2, 566, 575.1, 90.3; 379/433.04, 433.01, 433.06, 916; 345/173, 901, 905; 361/679.26, 361/679.27, 679.3, 679.55, 679.56, 361/680-686; 248/917-924; 348/373, 376; D19/60**

See application file for complete search history.

(56) **References Cited**
U.S. PATENT DOCUMENTS
 2,424,630 A 7/1947 Perez
 D262,151 S 12/1981 Sussman
 (Continued)
FOREIGN PATENT DOCUMENTS
 AU 315078 7/2007
 CA 72548 5/1993
 (Continued)
OTHER PUBLICATIONS

Apple.com, "Apple—iPhone—Gallery," (<http://web.archive.org/web/20070705201012/http://www.apple.com/iphone/gallery/index8.html>), dated Jul. 5, 2007, accessed Mar. 28, 2013, 1 page.
 (Continued)

Primary Examiner — Barbara Fox
 (74) *Attorney, Agent, or Firm* — Sterne, Kessler, Goldstein & Fox P.L.L.C.

(57) **CLAIM**
 The ornamental design for an electronic device, as shown and described.

DESCRIPTION

FIG. 1 is a bottom front perspective view of an electronic device showing our new design;
 FIG. 2 is a bottom rear perspective view thereof;
 FIG. 3 is a top front perspective view thereof;
 FIG. 4 is a top rear perspective view thereof;
 FIG. 5 is a front view thereof;
 FIG. 6 is a rear view thereof;
 FIG. 7 is a top view thereof;
 FIG. 8 is a bottom view thereof;
 FIG. 9 is a left side view thereof; and,
 FIG. 10 is a right side view thereof.
 The shade lines in the Figures show contour and not surface ornamentation.

1 Claim, 10 Drawing Sheets

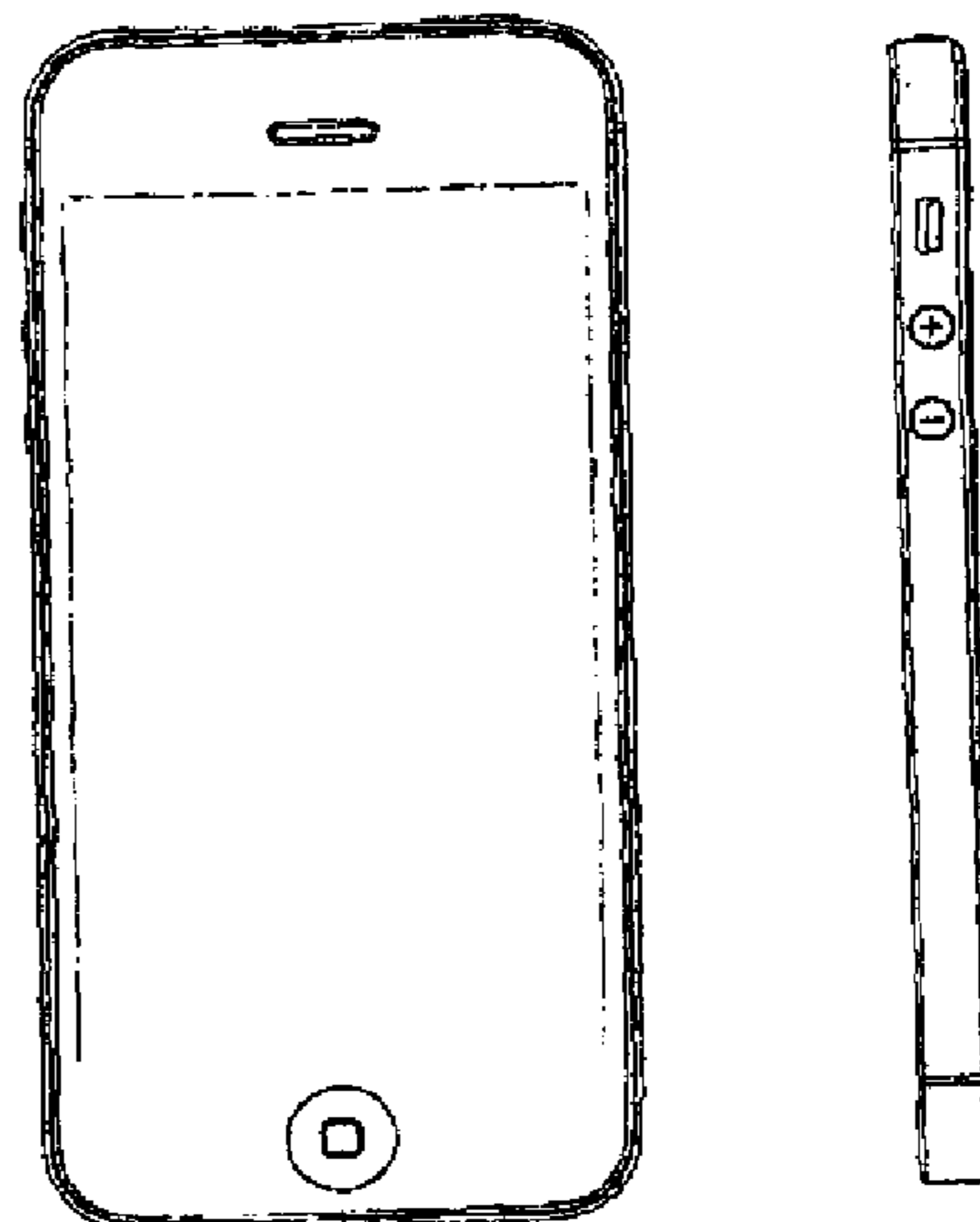
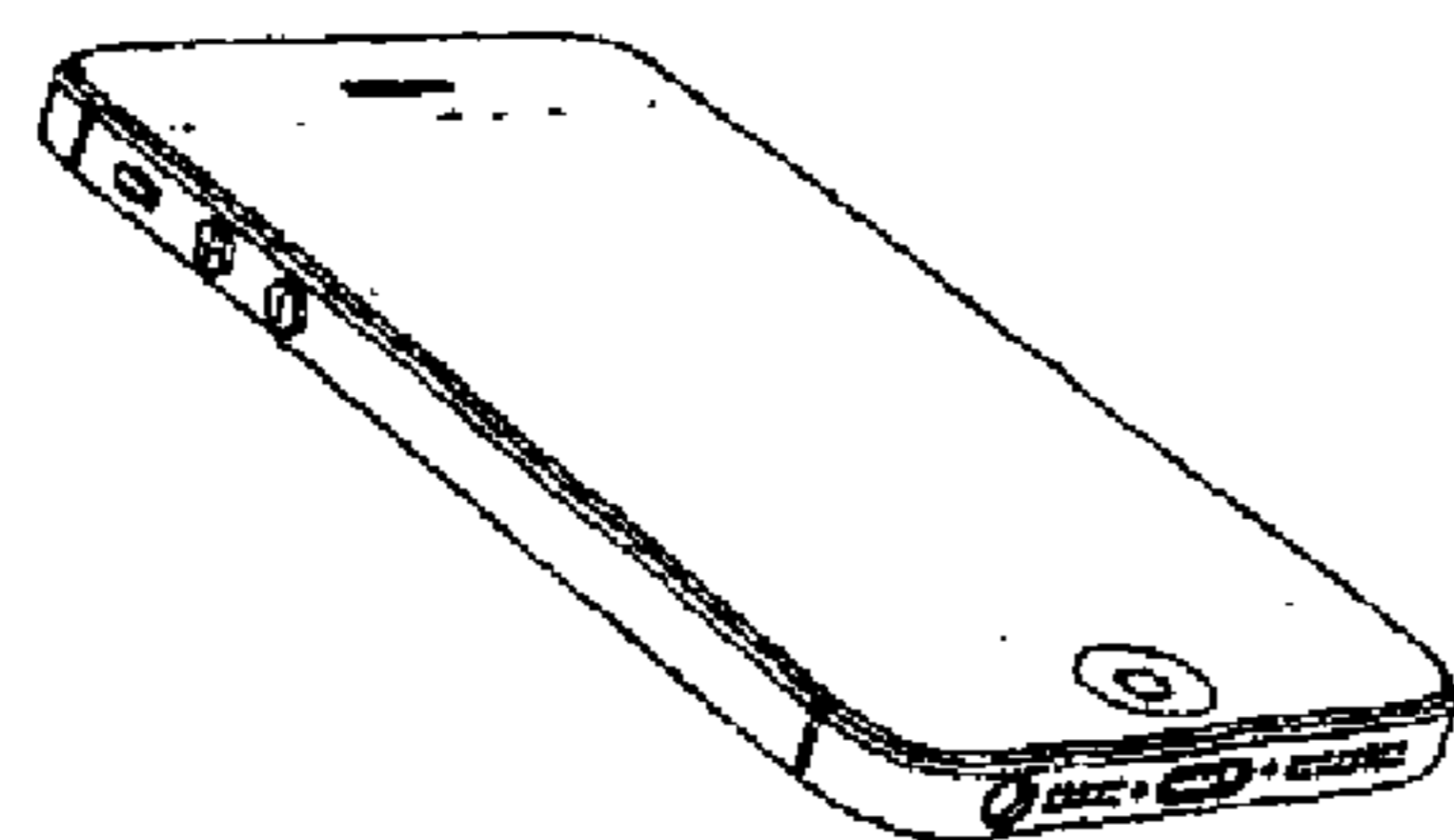

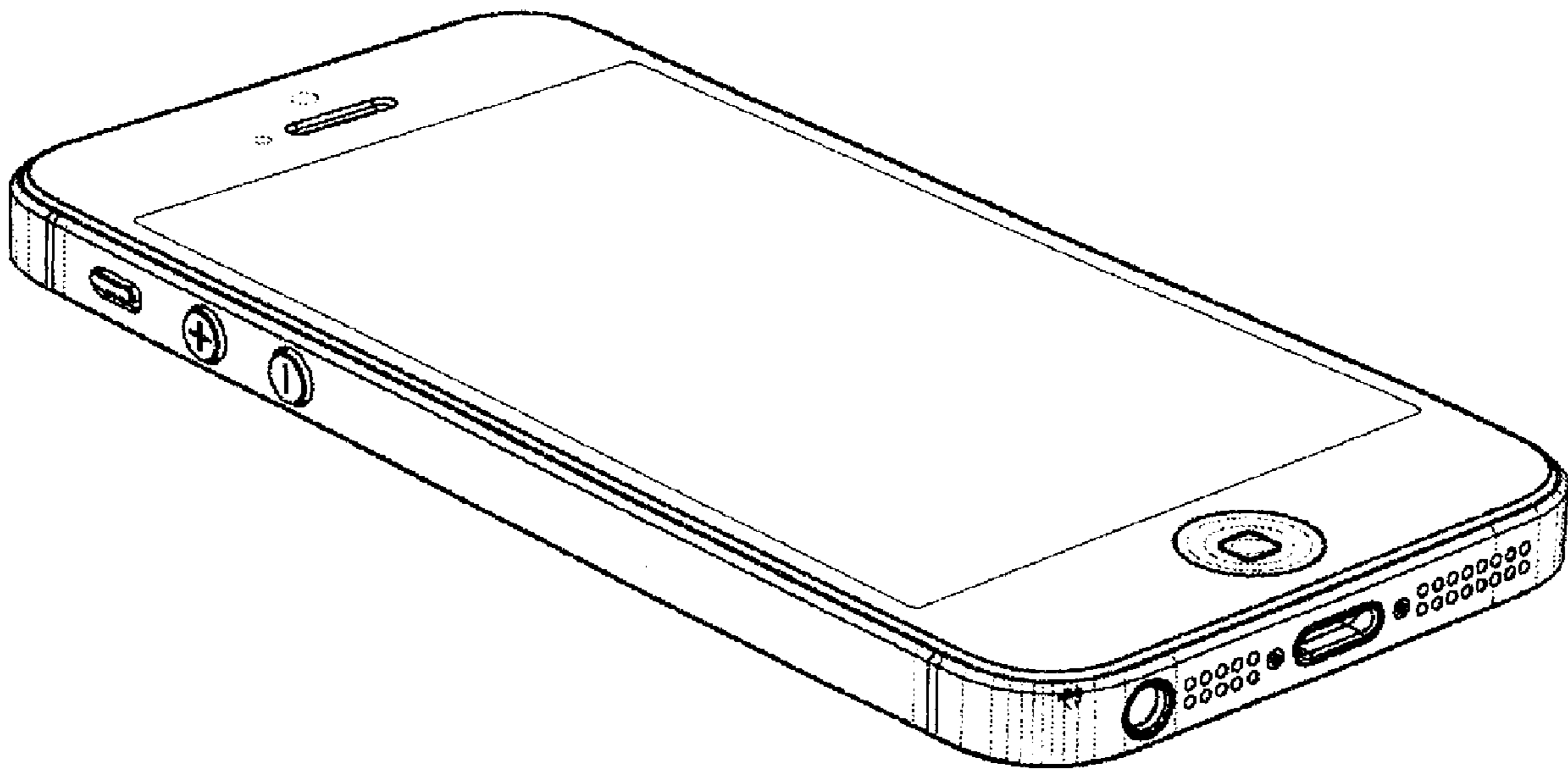

FIG. 1

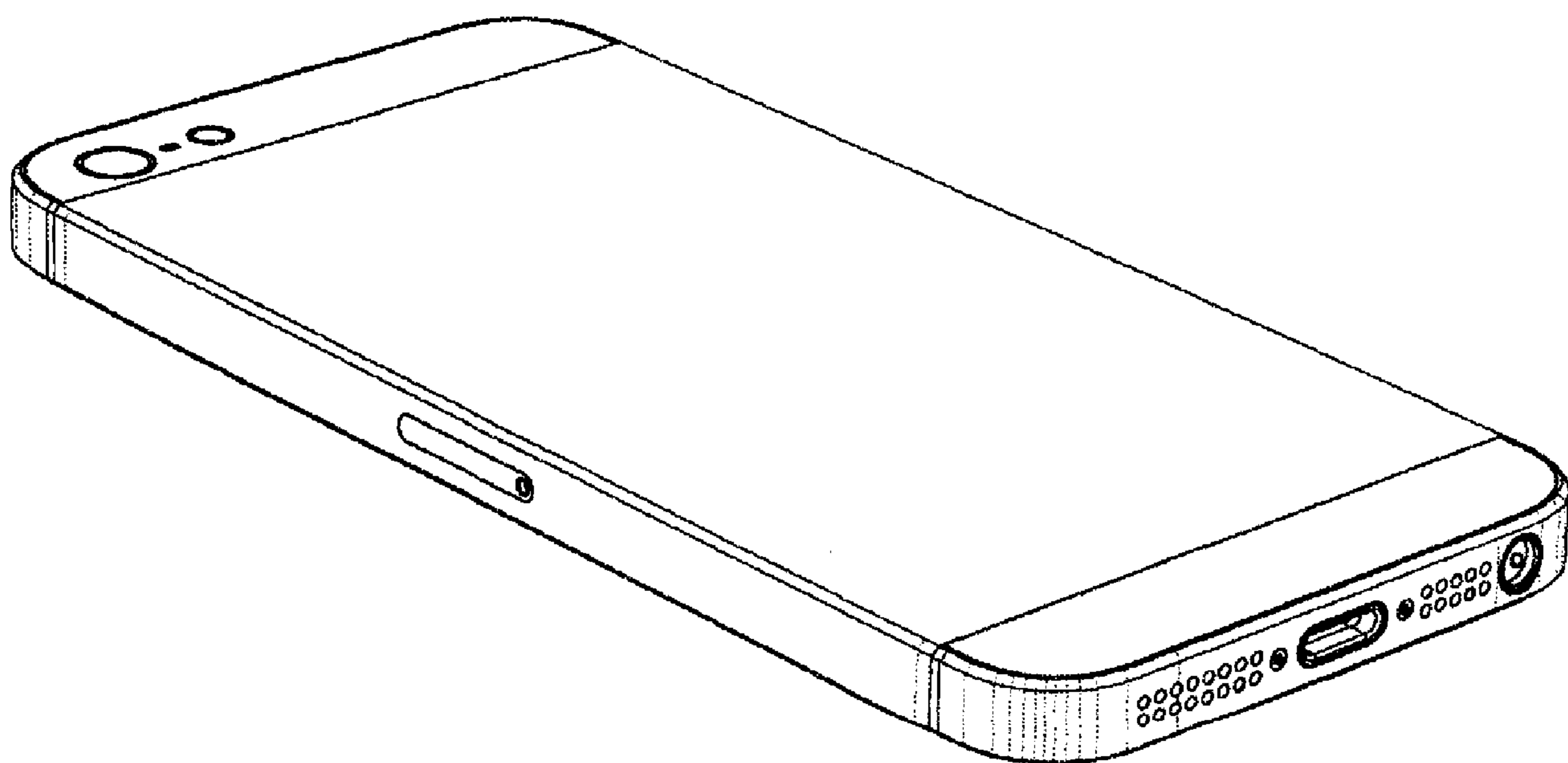

FIG. 2

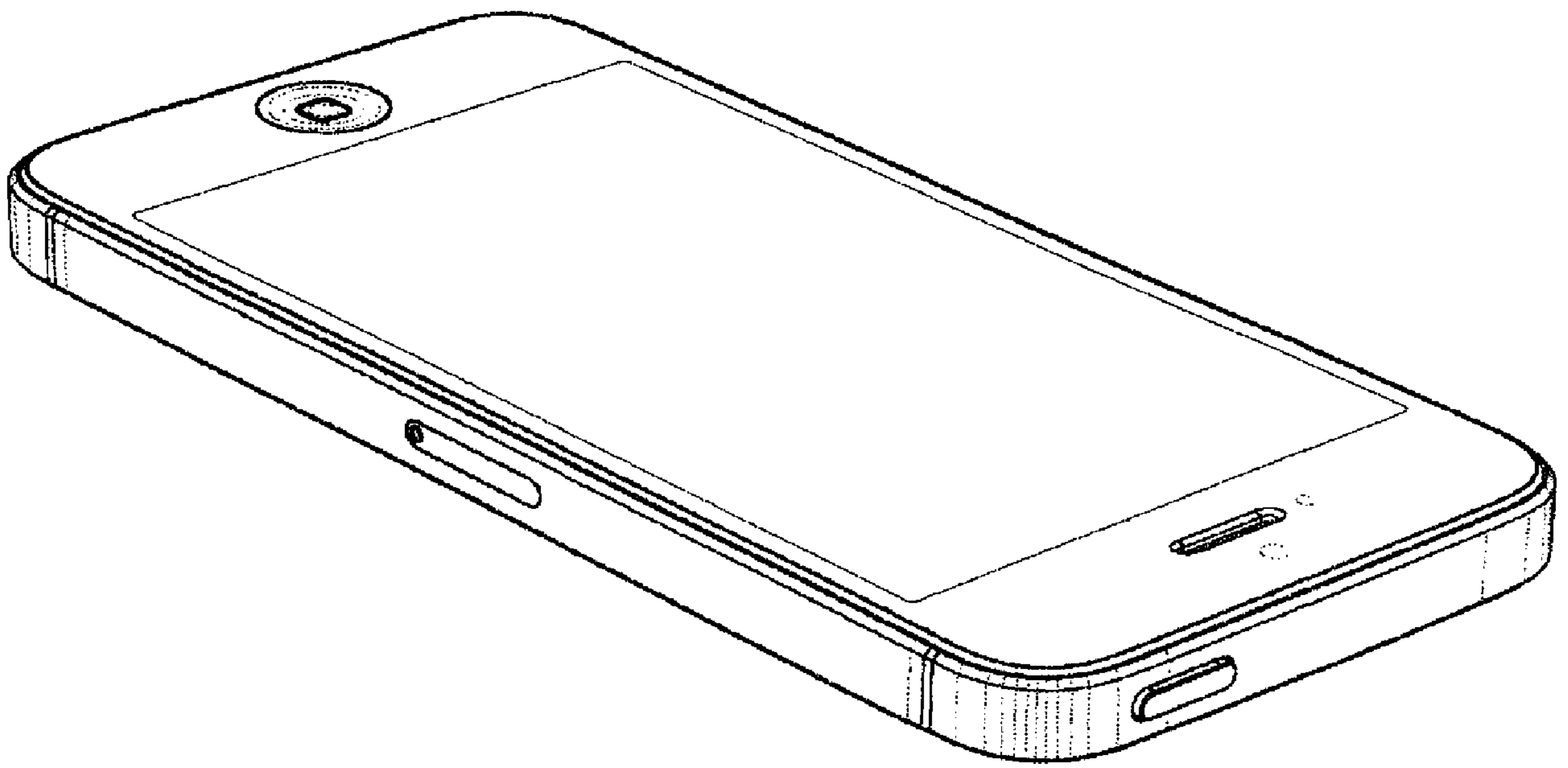

FIG. 3

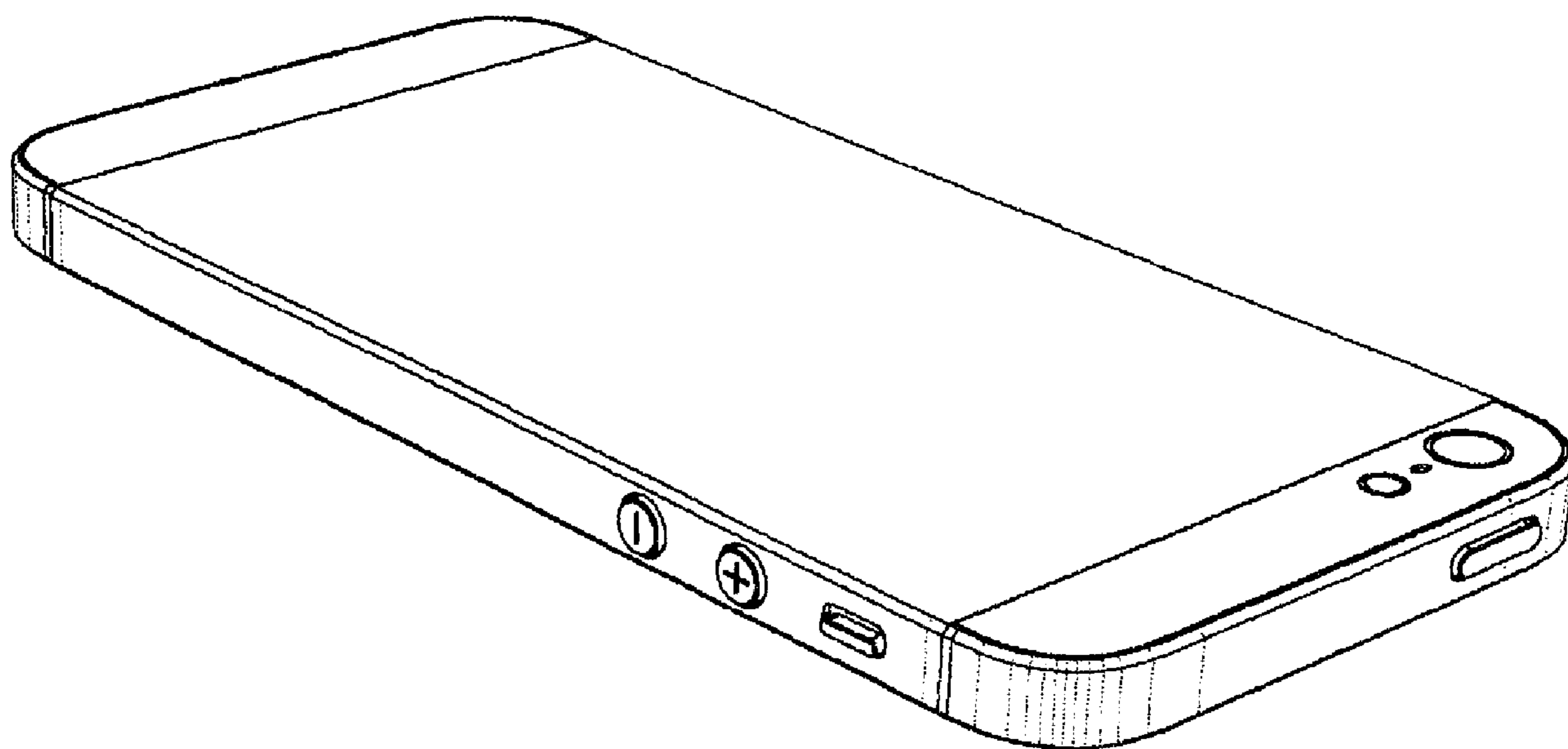

FIG. 4

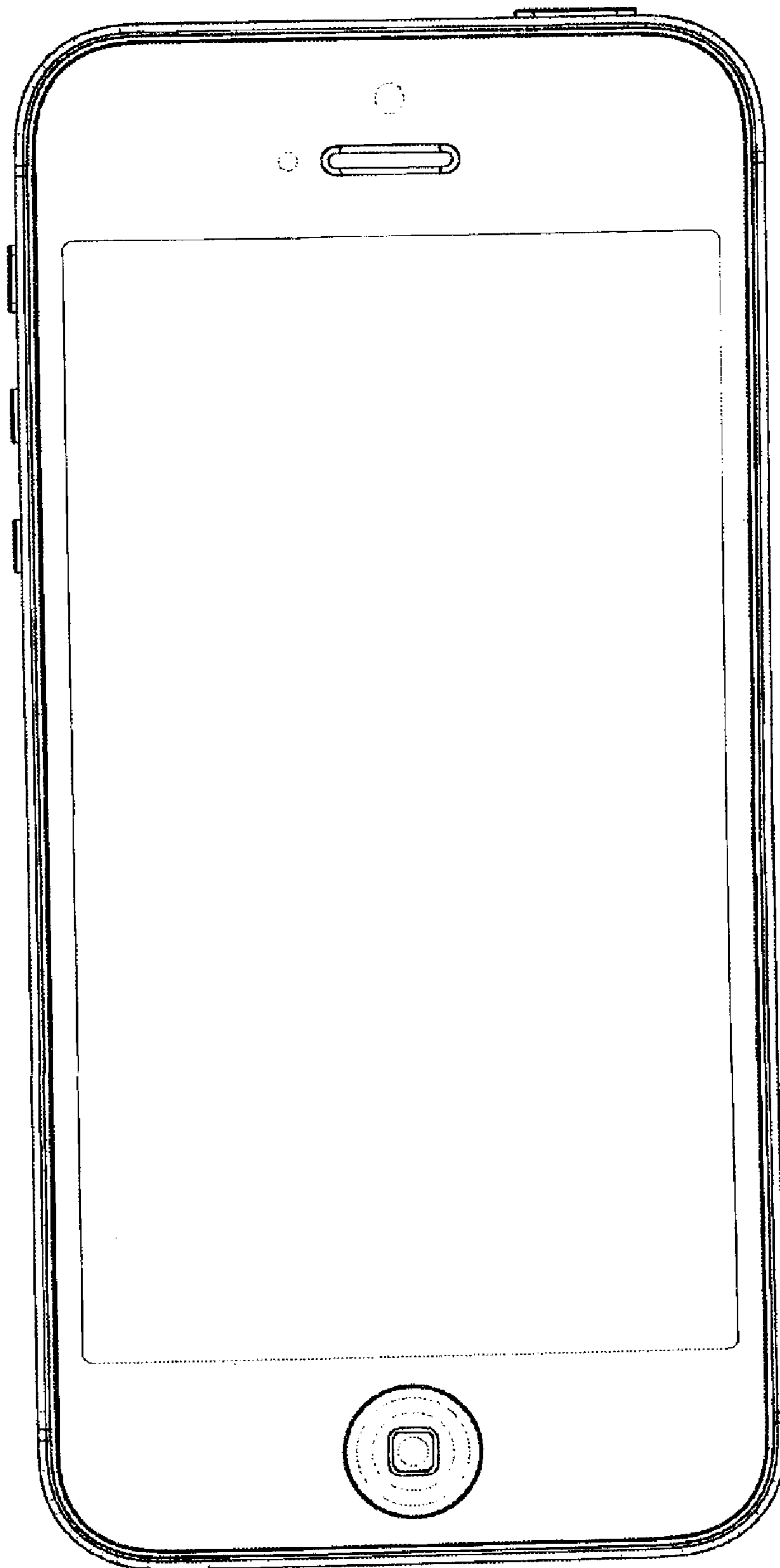

FIG. 5

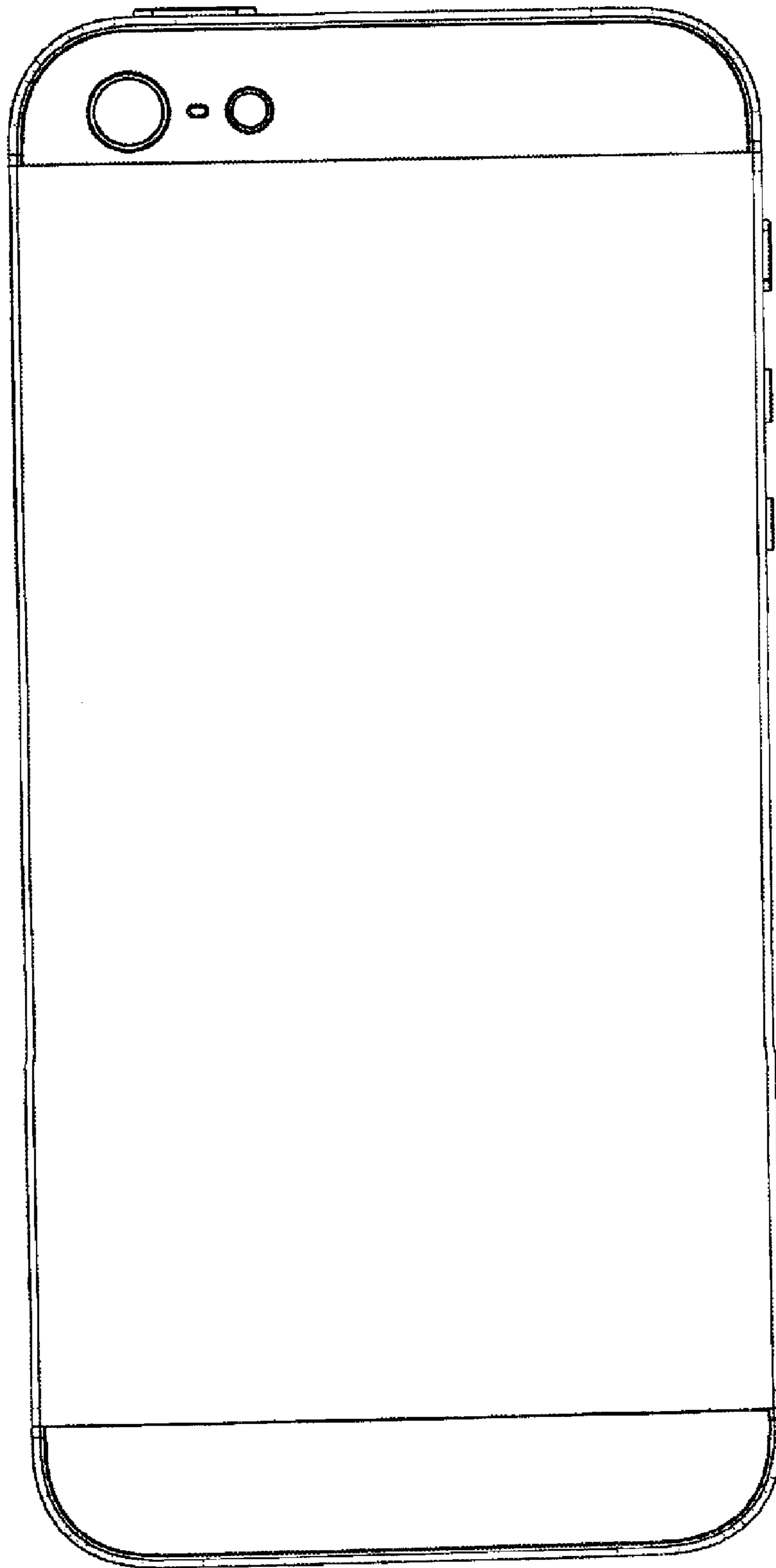

FIG. 6

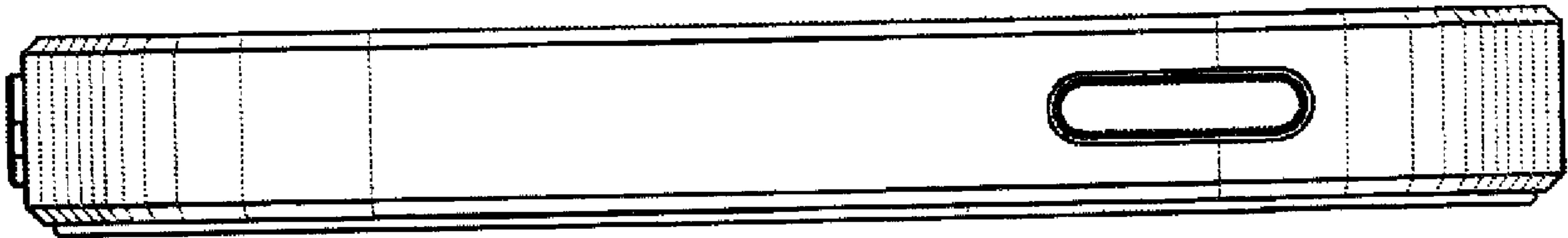

FIG. 7

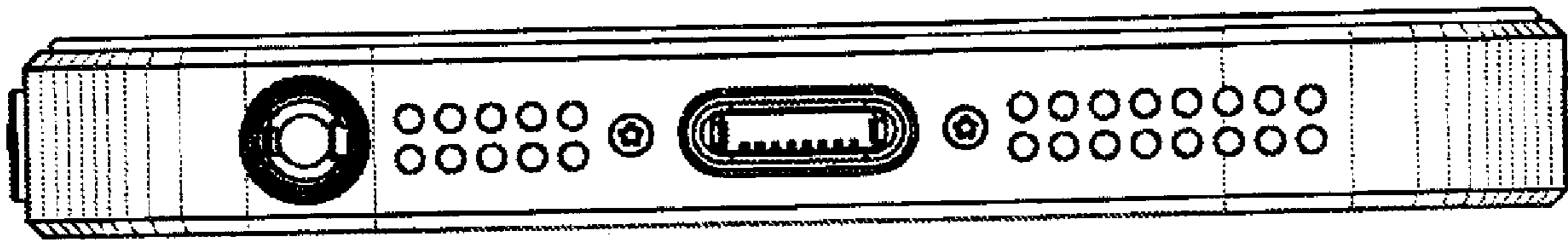

FIG. 8

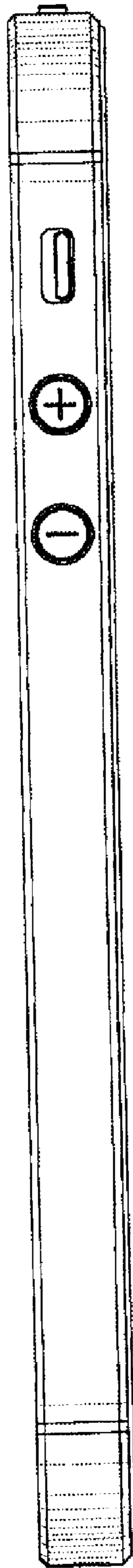

FIG. 9



FIG. 10