



US00D707047S

(12) **United States Design Patent**
Carter et al.

(10) **Patent No.:** **US D707,047 S**
(45) **Date of Patent:** **** Jun. 17, 2014**

(54) **VEHICLE SEAT**

(71) Applicants: **Raymond Carter**, Marina del Rey, CA (US); **Richard Ott**, Kuemmersbruck (DE); **Hermann Meiller**, Wernberg Koebnitz (DE)

(72) Inventors: **Raymond Carter**, Marina del Rey, CA (US); **Richard Ott**, Kuemmersbruck (DE); **Hermann Meiller**, Wernberg Koebnitz (DE)

(73) Assignee: **Grammer AG**, Amberg (DE)

(**) Term: **14 Years**

(21) Appl. No.: **29/437,049**

(22) Filed: **Nov. 13, 2012**

(30) **Foreign Application Priority Data**

Aug. 14, 2012 (EM) 002087551

(51) **LOC (10) Cl.** **06-01**

(52) **U.S. Cl.**
USPC **D6/356**

(58) **Field of Classification Search**

USPC D6/334-336, 364, 365, 366, 367, 374, D6/379, 380, 716, 716.1, 716.2, 716.3, D6/716.4; 297/232, 391, 396, 353, 452.1, 297/452.24, 452.25, 452.26, 452.34, 452.35
See application file for complete search history.

(56) **References Cited**

U.S. PATENT DOCUMENTS

D298,986 S * 12/1988 Carter D6/356
D426,392 S * 6/2000 Ott et al. D6/356
D440,797 S * 4/2001 Norman D6/716.2

D536,545 S * 2/2007 Young D6/356
D612,163 S * 3/2010 Wagener D6/356
D617,104 S * 6/2010 Wagener D6/356
D651,002 S * 12/2011 Fleming D6/356
D651,003 S * 12/2011 Fleming D6/356
D651,004 S * 12/2011 Fleming D6/356
D653,866 S * 2/2012 Wada D6/356
D672,160 S * 12/2012 Wagener D6/356

* cited by examiner

Primary Examiner — Mimoso De

(74) *Attorney, Agent, or Firm* — Von Rohrscheidt Patents

(57) **CLAIM**

The ornamental design for a vehicle seat, as shown and described.

DESCRIPTION

FIG. 1 illustrates a left tilted side view of an embodiment of the vehicle seat showing the new design.

FIG. 2 illustrates a left side view of the vehicle seat in FIG. 1.

FIG. 3 illustrates a right side view of the vehicle seat in FIG. 1.

FIG. 4 illustrates a front view of the vehicle seat in FIG. 1.

FIG. 5 illustrates a back view of the vehicle seat in FIG. 1.

FIG. 6 illustrates a top view of the vehicle seat in FIG. 1.

FIG. 7 illustrates a left tilted side view of a second embodiment of the vehicle seat showing the new design.

FIG. 8 illustrates a left side view of the vehicle seat in FIG. 7.

FIG. 9 illustrates a right side view of the vehicle seat in FIG. 7.

FIG. 10 illustrates a front view of the vehicle seat in FIG. 7.

FIG. 11 illustrates a rear side view of the vehicle seat in FIG. 7; and,

FIG. 12 illustrates a top view of the vehicle seat in FIG. 7.

1 Claim, 12 Drawing Sheets

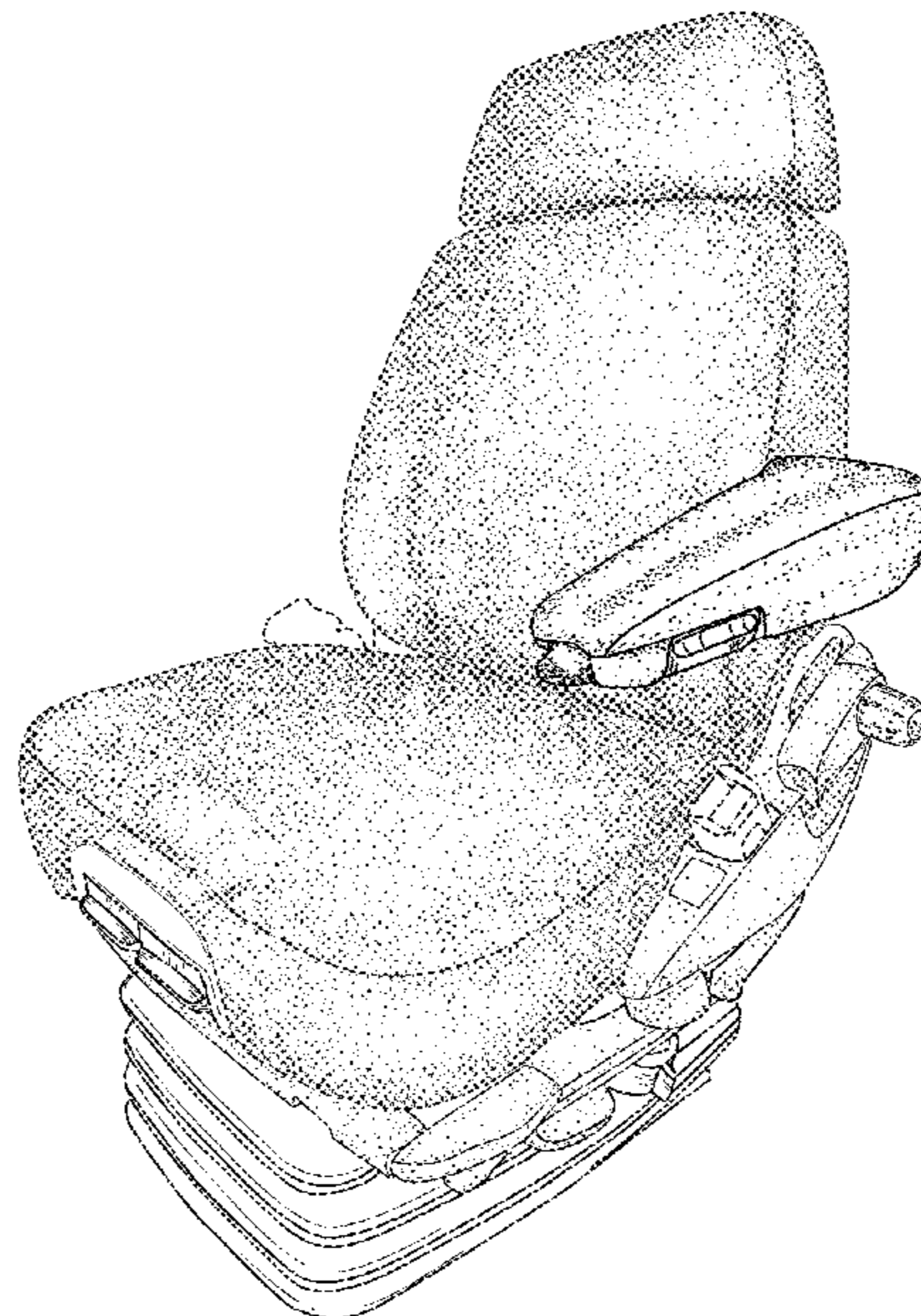
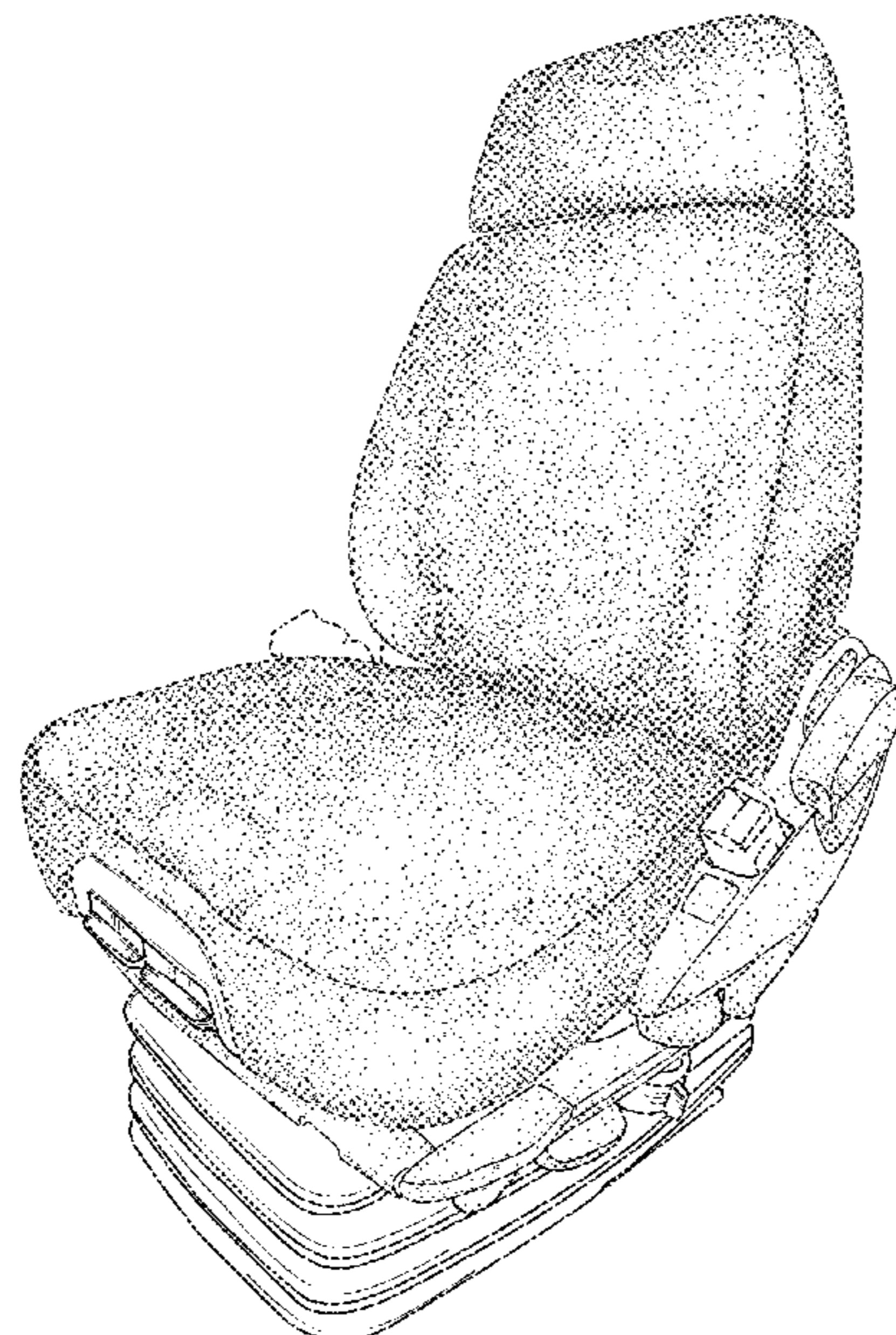

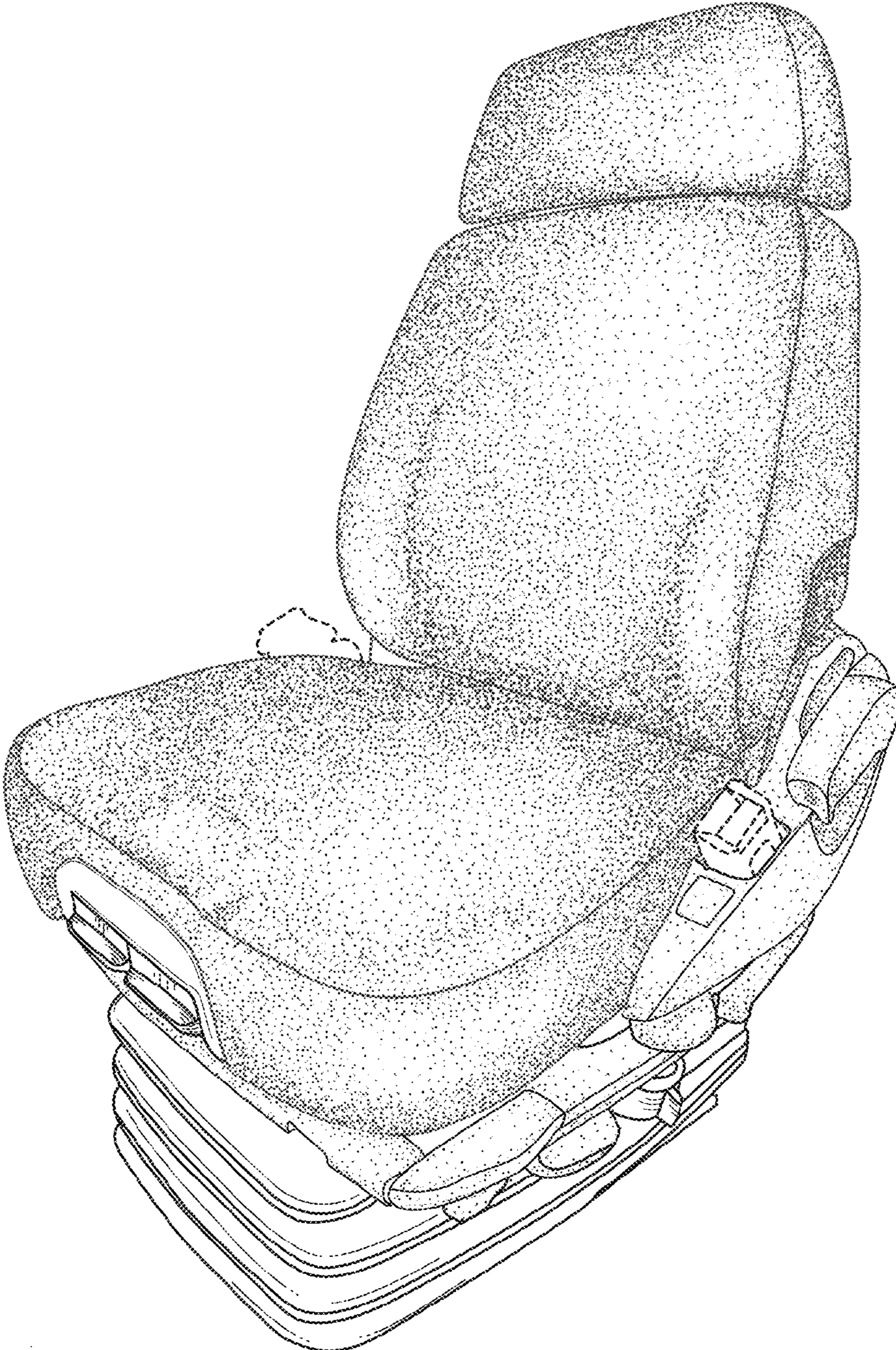

FIG. 1

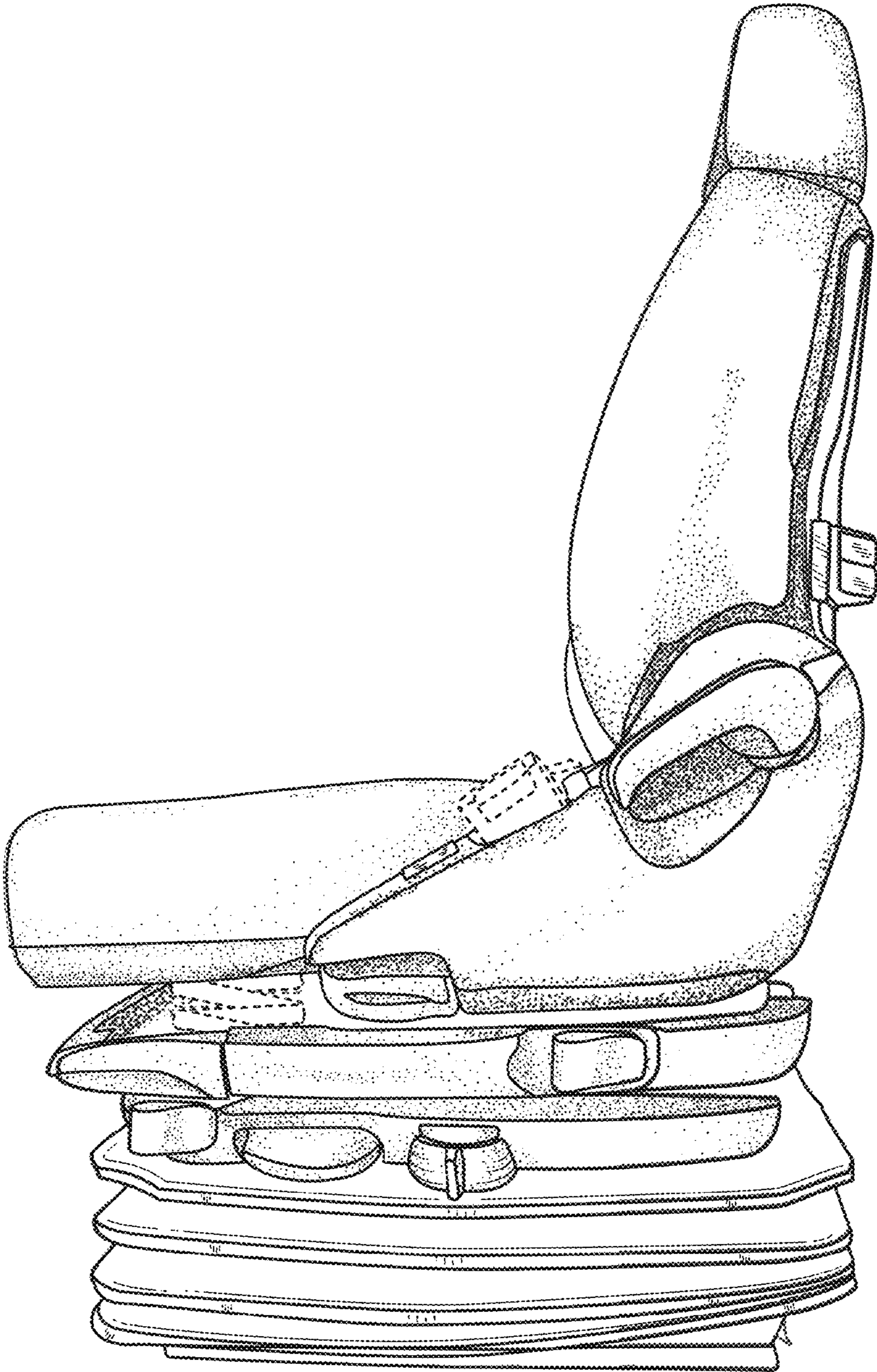

FIG. 2

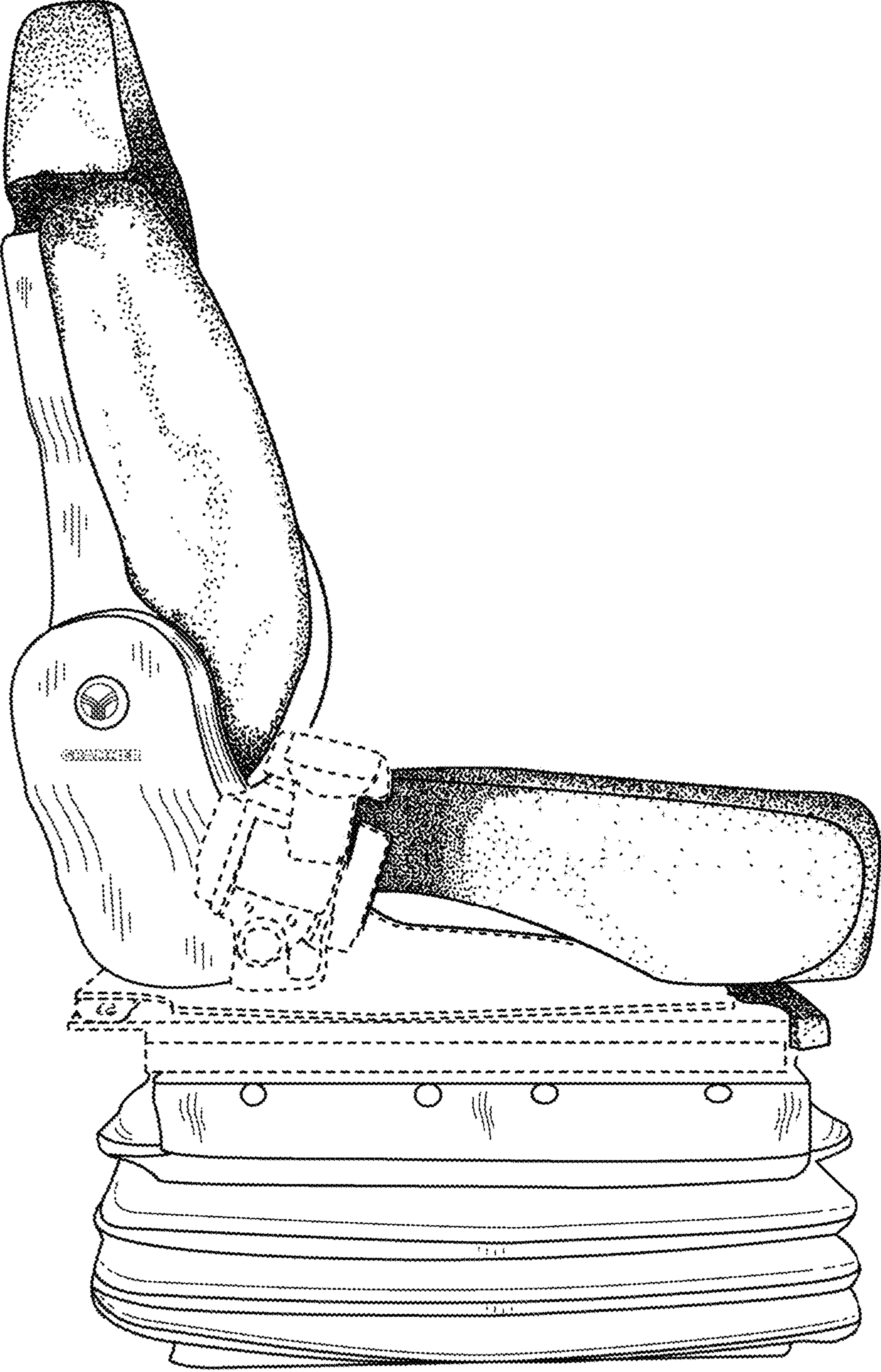

FIG. 3

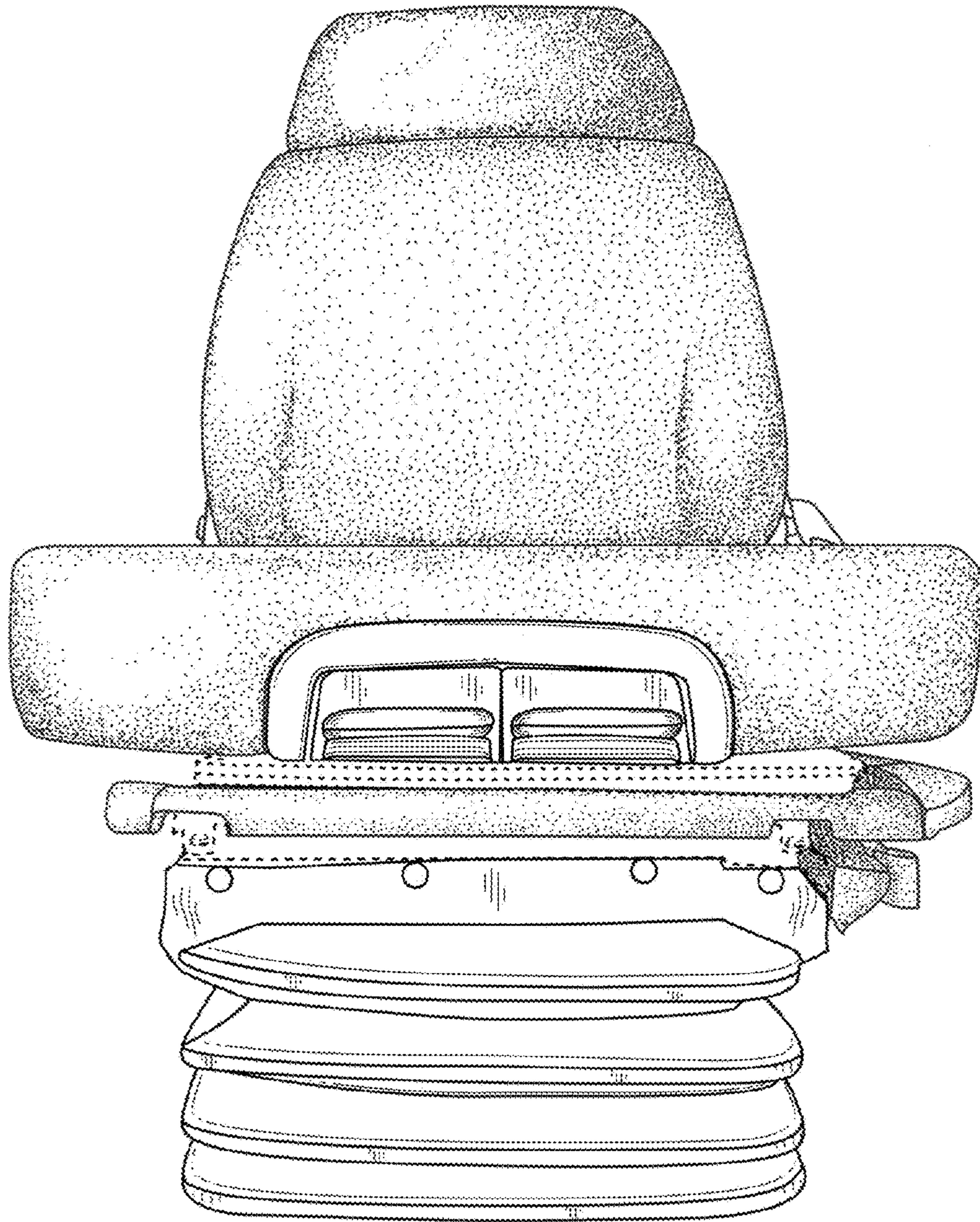

FIG. 4

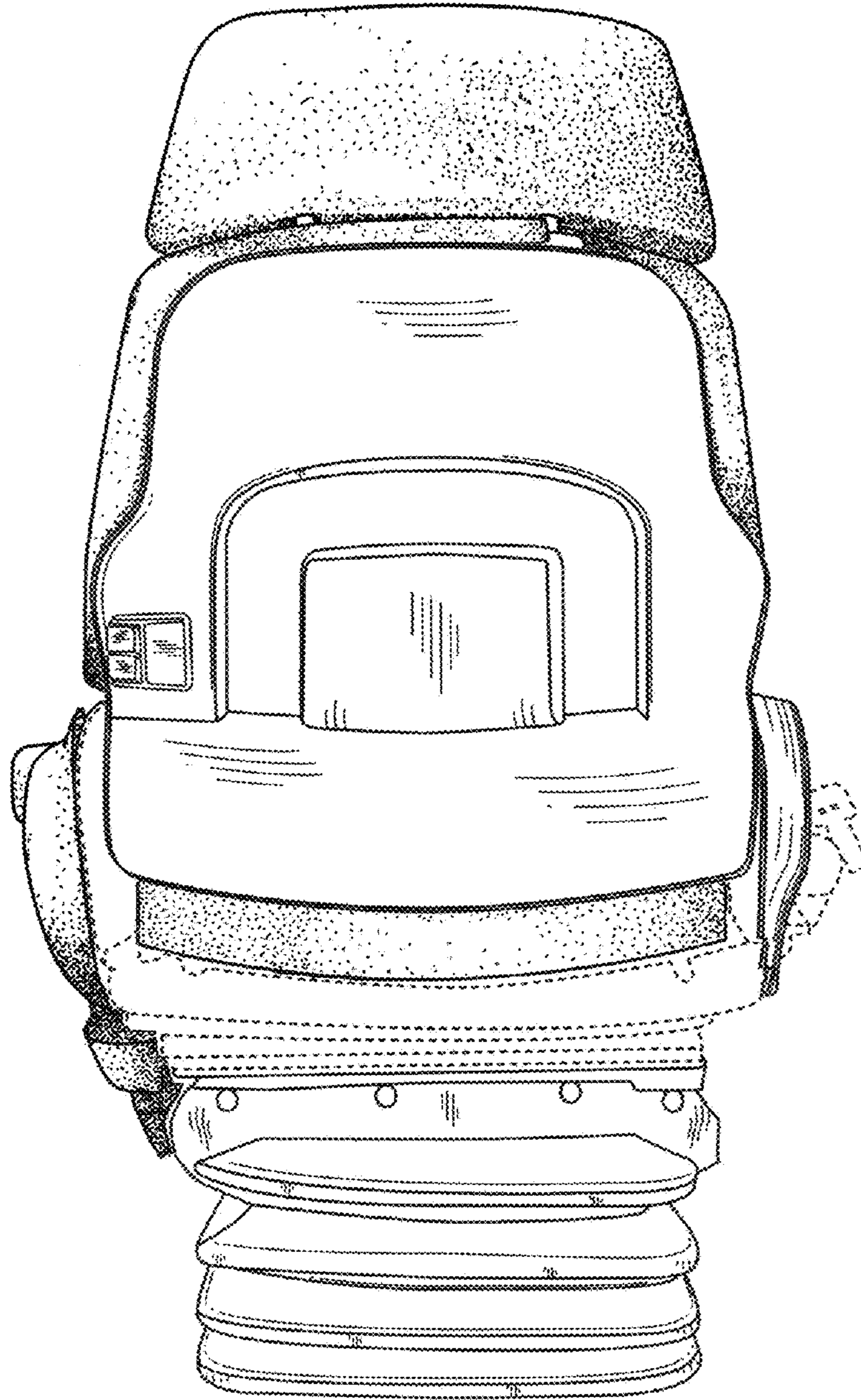

FIG. 5

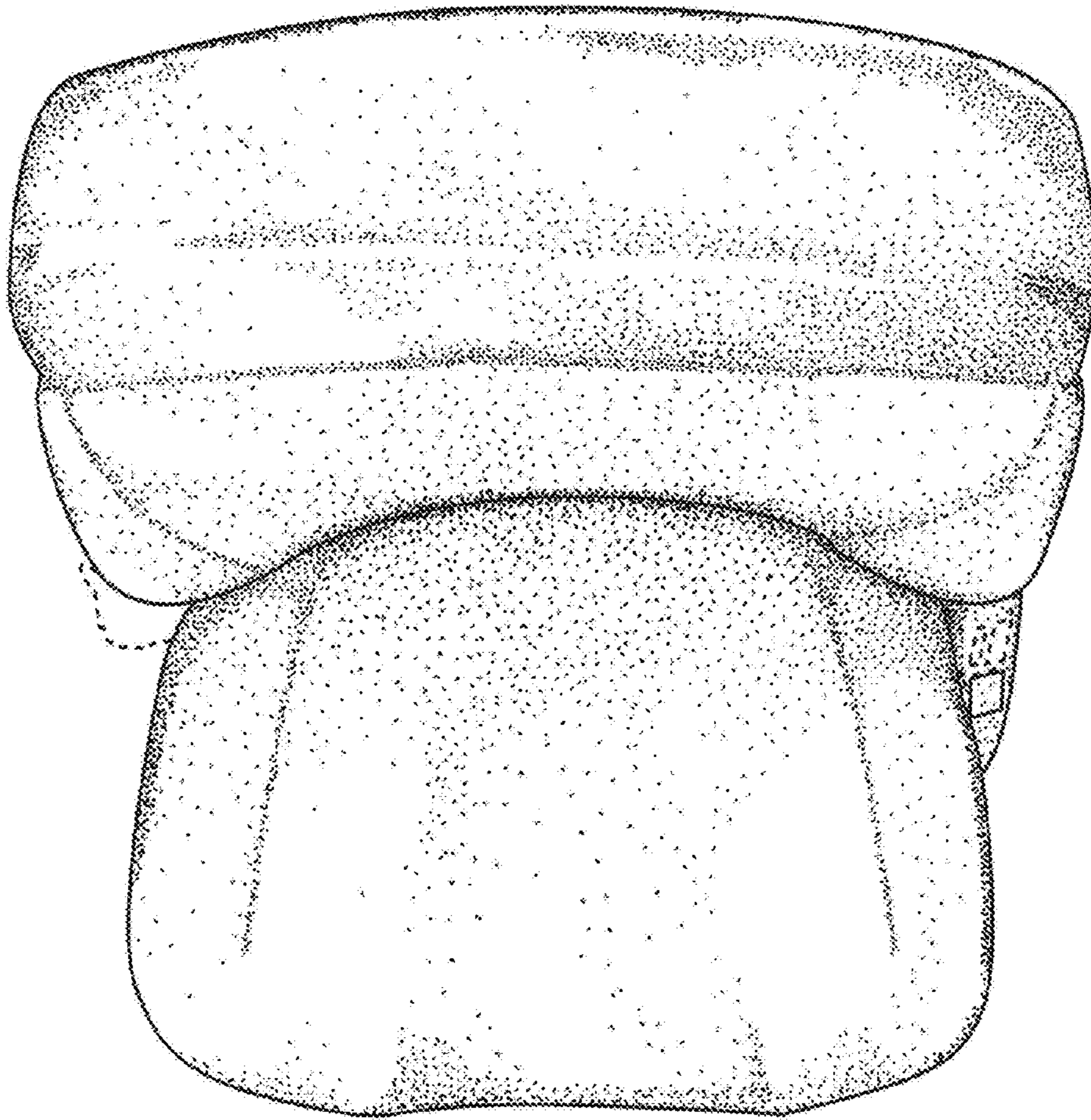

FIG. 6

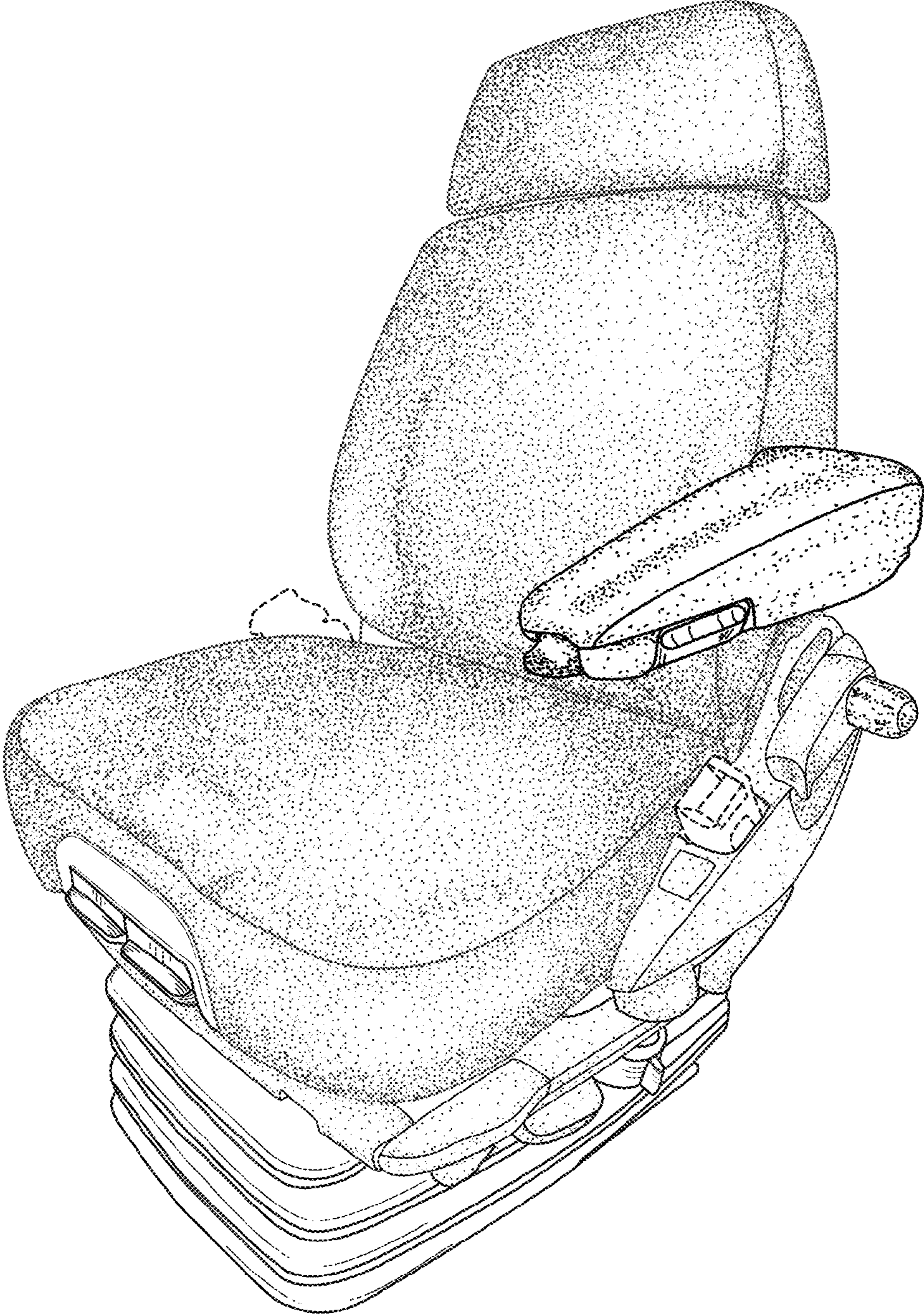

FIG. 7

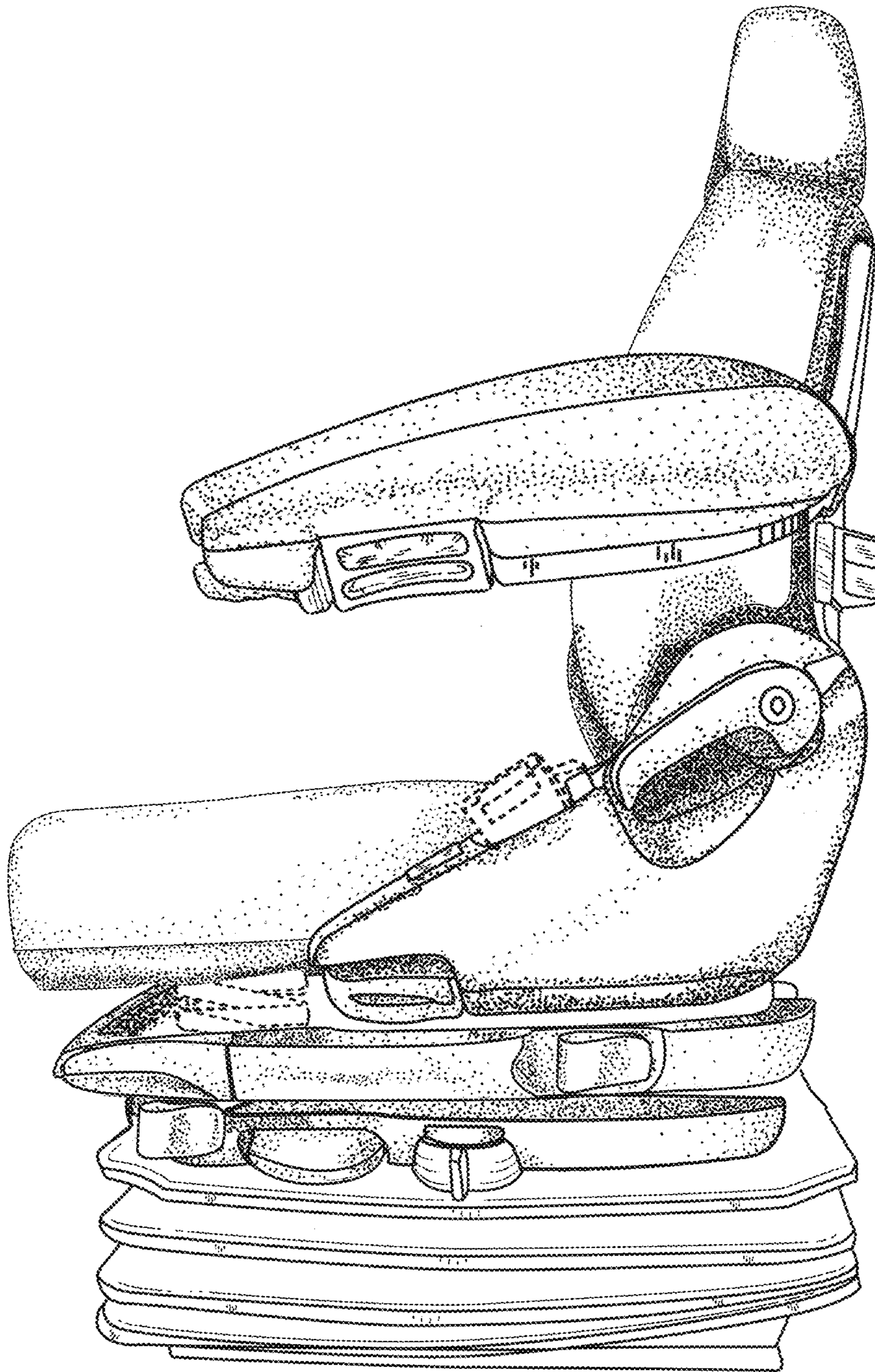

FIG. 8

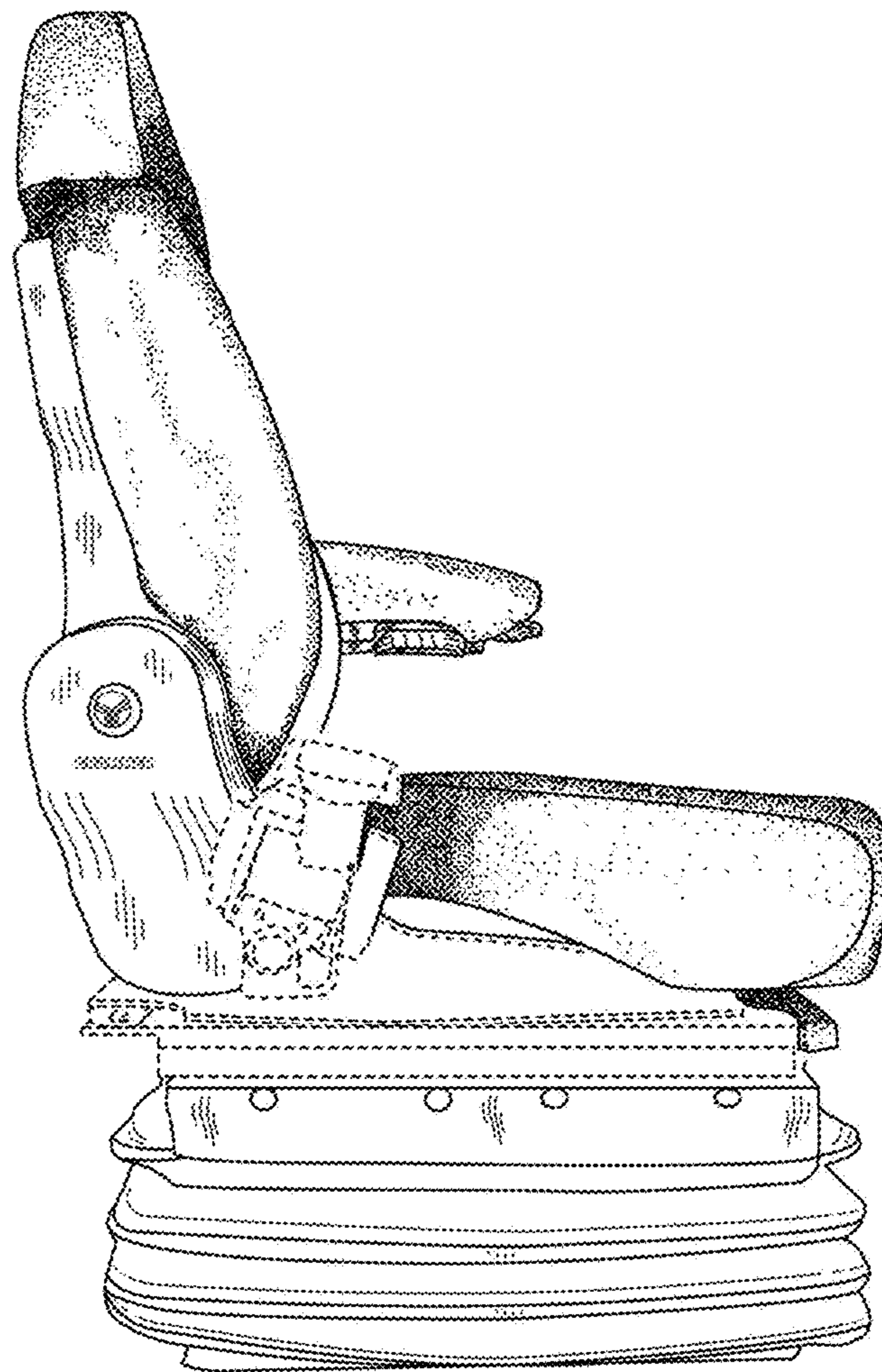

FIG. 9

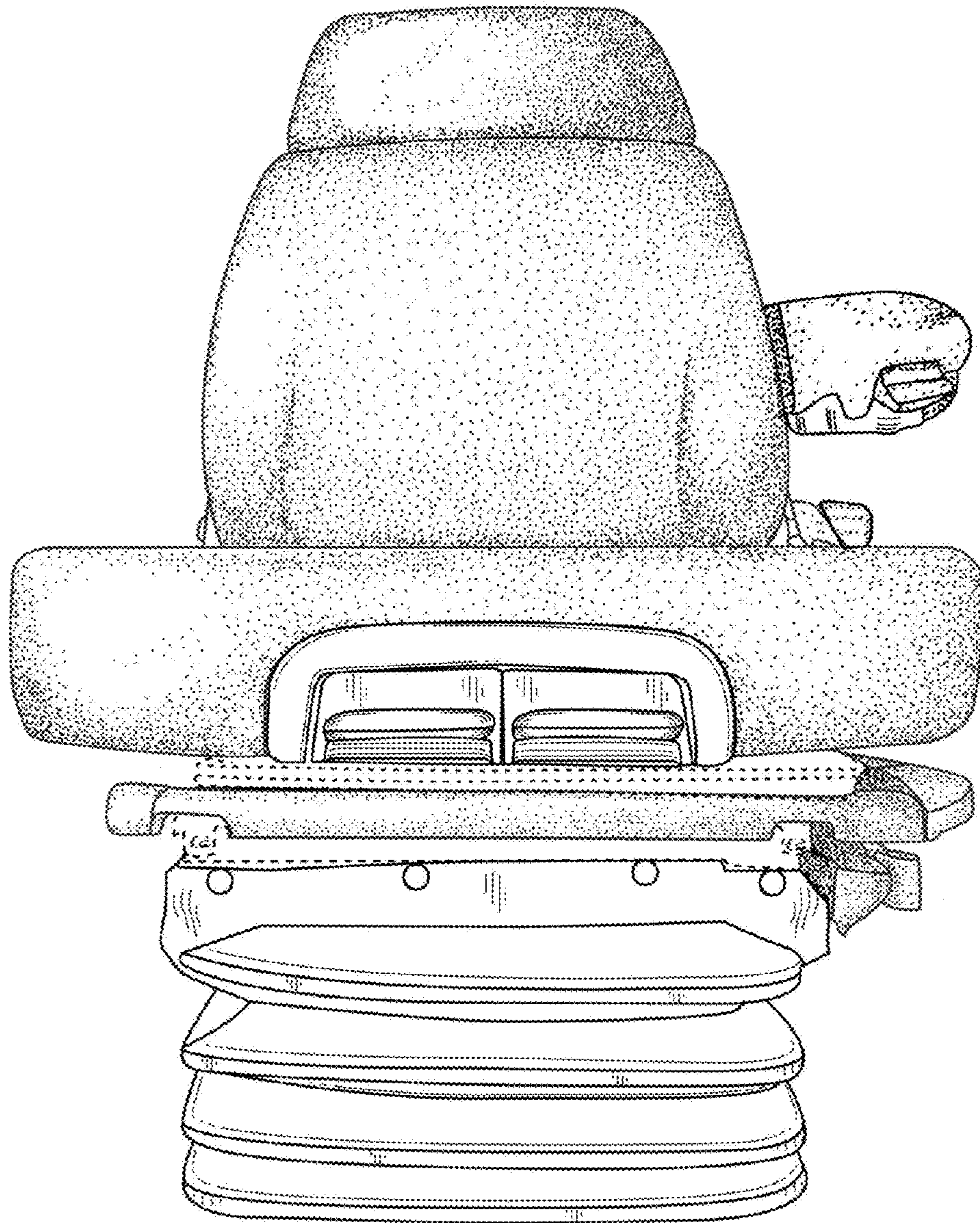

FIG. 10

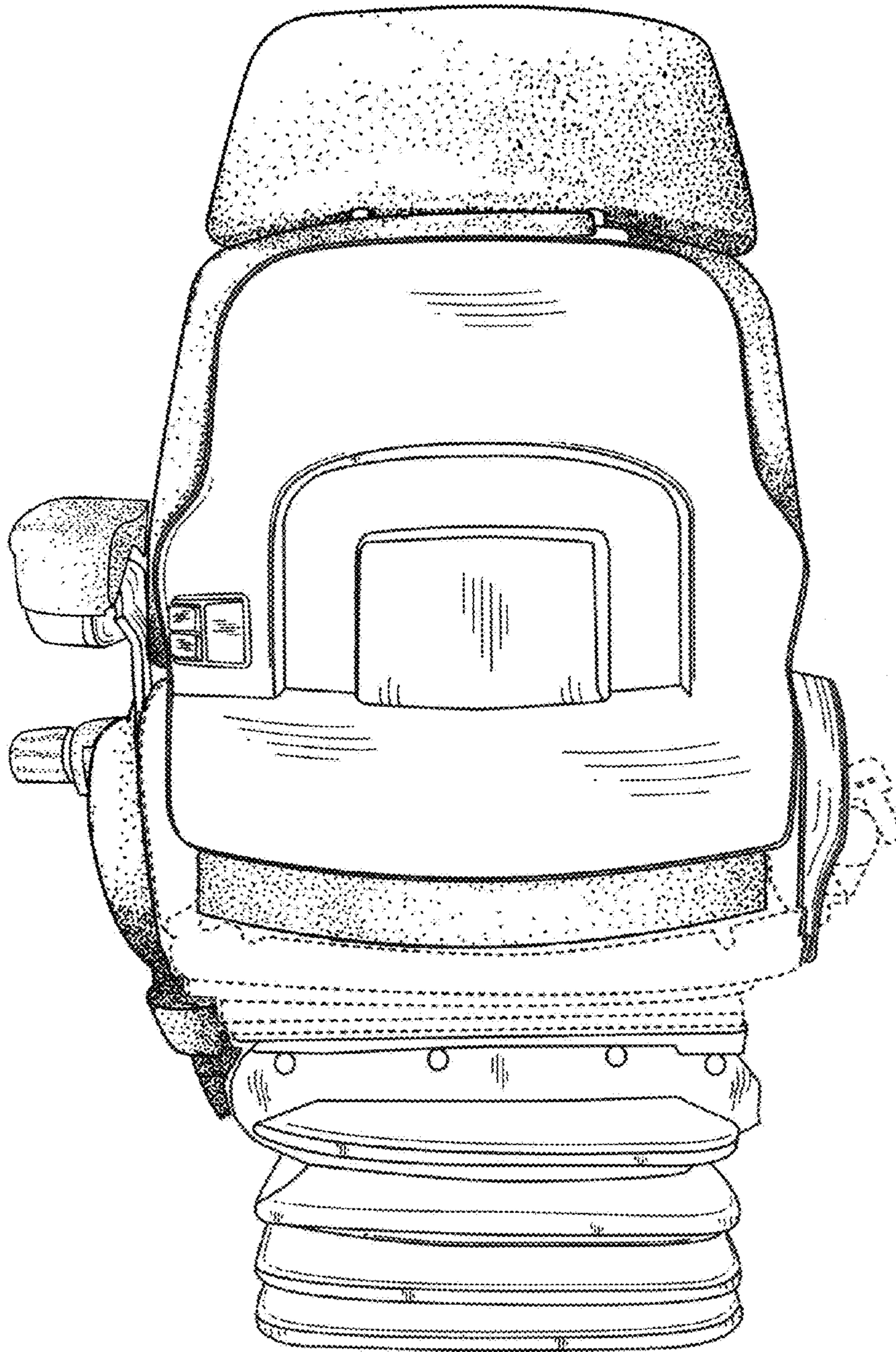

FIG. 11

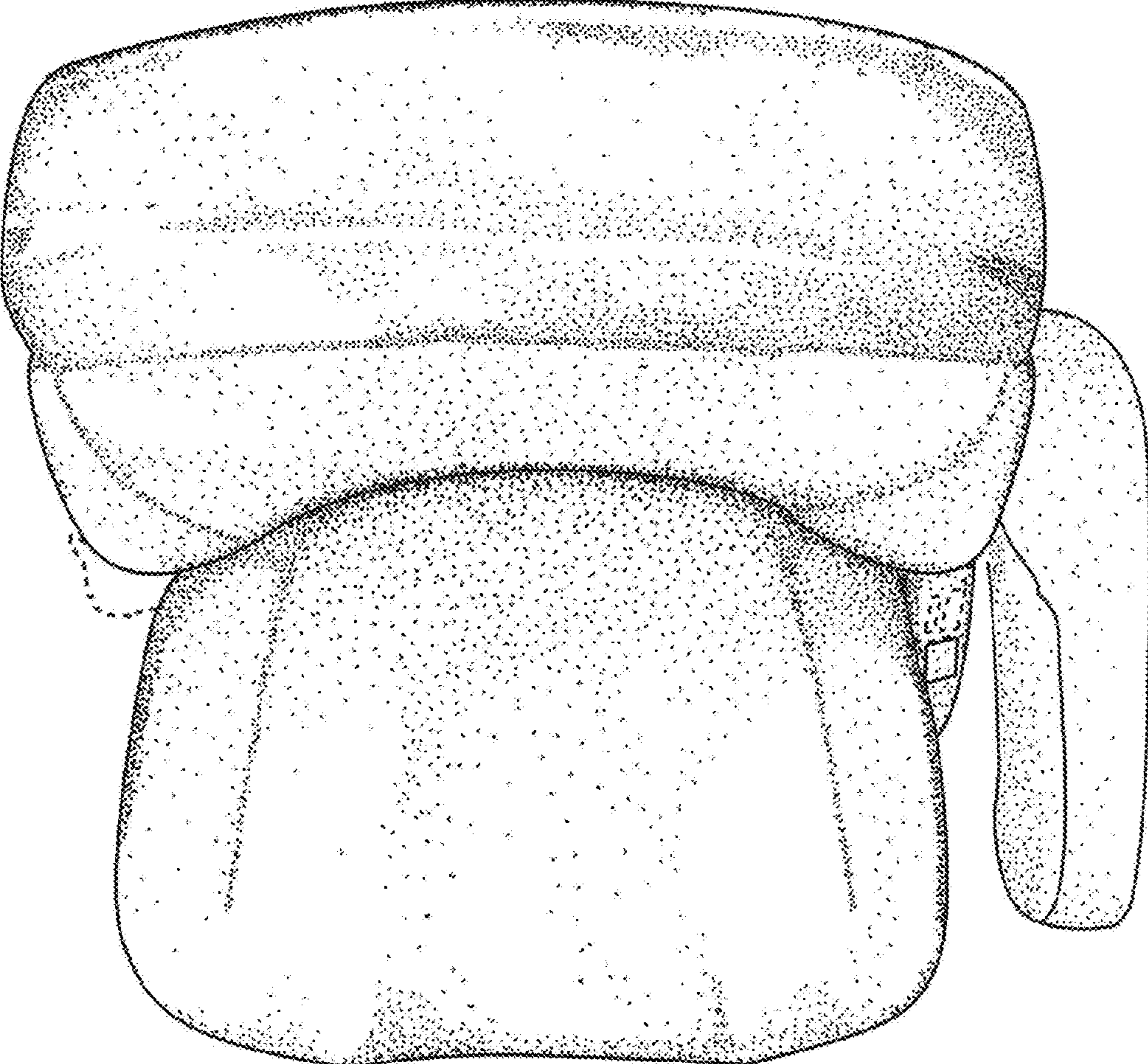

FIG. 12