



US00D707009S

(12) **United States Design Patent**  
**Walter**

(10) **Patent No.:** **US D707,009 S**  
(45) **Date of Patent:** **\*\* Jun. 10, 2014**

- (54) **HANDLE COVER**
- (75) Inventor: **Ivor Michel Walter**, Boulder, CO (US)
- (73) Assignee: **AMSA, Inc.**, Boulder, CO (US)
- (\*\*) Term: **14 Years**
- (21) Appl. No.: **29/412,073**
- (22) Filed: **Jan. 30, 2012**
- (51) **LOC (10) Cl.** ..... **12-02**
- (52) **U.S. Cl.**  
USPC ..... **D34/27**
- (58) **Field of Classification Search**  
USPC ..... D34/12-27; 280/33.992, 33.991,  
280/33.993, 47.17; 150/153, 154; D25/144  
See application file for complete search history.

(56) **References Cited**

**U.S. PATENT DOCUMENTS**

3,337,227	A	8/1967	Castaldo	
3,429,403	A	2/1969	Drechsler	
D238,663	S	2/1976	Schifman	
D294,419	S	2/1988	Rehrig	
D298,077	S	10/1988	Goodwin	D34/27
4,868,544	A	* 9/1989	Havens	340/568.5
D328,812	S	8/1992	Pritchett	
5,244,930	A	* 9/1993	Trudell et al.	521/99
5,250,789	A	10/1993	Johnsen	
D341,691	S	* 11/1993	Begum et al.	D34/27
5,265,893	A	11/1993	Ettlin	
D348,549	S	7/1994	Trubiano	
5,435,582	A	7/1995	Davidson	
D368,564	S	4/1996	Trubiano	
5,507,507	A	4/1996	Davidson	

(Continued)

**OTHER PUBLICATIONS**

Premier Carts 3 Peg Snap-On Handle [[http://premiercarts.com/PC\\_HT3P.html](http://premiercarts.com/PC_HT3P.html)].

(Continued)

*Primary Examiner* — Cynthia Ramirez  
(74) *Attorney, Agent, or Firm* — Margaret Polson; Oppedahl Patent Law Firm, LLC

(57) **CLAIM**

The ornamental design for a handle cover, as shown and described.

**DESCRIPTION**

FIG. 1 is a top side perspective view of a handle cover, the attachment not being shown for convenience of illustration; FIG. 2 is a top plan view thereof; FIG. 3 is a bottom plan view thereof; FIG. 4 is a left and right side elevational view thereof, both sides being identical; FIG. 5 is a front and back elevational view thereof, both being identical; FIG. 6 is a top perspective view of the handle cover showing a clear cover in place; FIG. 7 is a top plan view thereof; FIG. 8 is a bottom plan view thereof; FIG. 9 is a left and right side elevational view thereof, both sides being identical; FIG. 10 is a front and back elevational view thereof, both being identical; FIG. 11 is a top side perspective view of the clear cover, the handle cover not being shown for convenience of illustration; FIG. 12 is a bottom plan view thereof; FIG. 13 is a top plan view thereof; FIG. 14 is a bottom plan view thereof; FIG. 15 is a left and right side elevational view thereof, both sides being identical; and, FIG. 16 is a front and back elevational view thereof, both being identical.

The broken line showing of attachment holes and attachment tabs is included for the purpose of illustrating portions of the handle cover and forms no part of the claimed design.

**1 Claim, 4 Drawing Sheets**

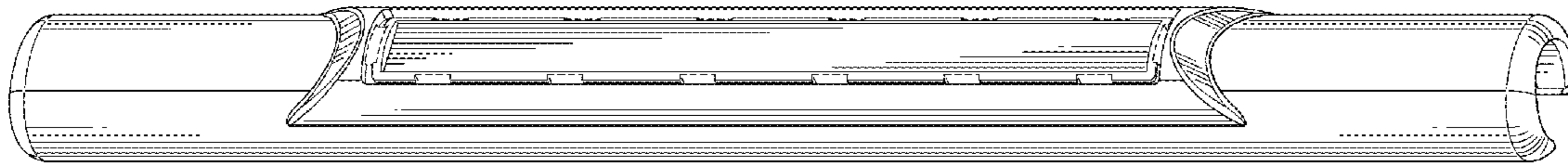

(56)

**References Cited**

U.S. PATENT DOCUMENTS

D370,110 S 5/1996 Beam  
 5,553,877 A 9/1996 Huang  
 D379,834 S 6/1997 Huang  
 5,702,114 A 12/1997 Downing et al.  
 D425,681 S \* 5/2000 Johnson et al. .... D34/27  
 D431,704 S 10/2000 Perez  
 D445,230 S 7/2001 Deal et al.  
 D449,913 S 10/2001 Walter  
 D455,243 S 4/2002 Walter  
 6,406,041 B1 6/2002 Rea  
 D470,292 S 2/2003 Johnson et al.  
 D472,026 S 3/2003 Walter  
 D472,027 S 3/2003 Walter  
 6,543,794 B1 4/2003 Tyree  
 6,679,506 B2 1/2004 Koppes et al.  
 D525,008 S \* 7/2006 Hubbard ..... D34/27  
 D538,501 S 3/2007 Walter  
 D542,997 S 5/2007 Coderre  
 D564,172 S 3/2008 Steinhobel

D580,619 S 11/2008 Walter  
 D605,823 S 12/2009 Walter  
 D605,824 S \* 12/2009 DiMento ..... D34/27  
 D606,723 S 12/2009 Walter  
 D635,733 S \* 4/2011 Willig et al. .... D34/27  
 D638,602 S 5/2011 Walter  
 D645,631 S 9/2011 Walter  
 2004/0051263 A1 3/2004 Prather et al.  
 2008/0303230 A1\* 12/2008 Somberg ..... 280/33.992

OTHER PUBLICATIONS

Premier Carts 4 Peg Snap-On Handle [[http://premiercarts.com/TS\\_HT4P.html](http://premiercarts.com/TS_HT4P.html)].  
 Premier Carts Generic Snap-On Handle [[http://premiercarts.com/PC\\_HT-GEN.html](http://premiercarts.com/PC_HT-GEN.html)].  
 Premier Carts Tote Cart Replacement Handle [[http://premiercarts.com/PC\\_HT-Tote.html](http://premiercarts.com/PC_HT-Tote.html)].  
 Premier Carts United Steel & Wire Replacement Handle [[http://www.premiercarts.com/PC\\_HT-USW.html](http://www.premiercarts.com/PC_HT-USW.html)].

\* cited by examiner

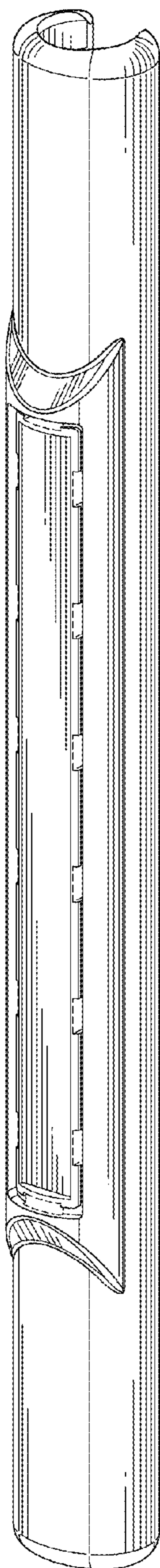

FIG. 1

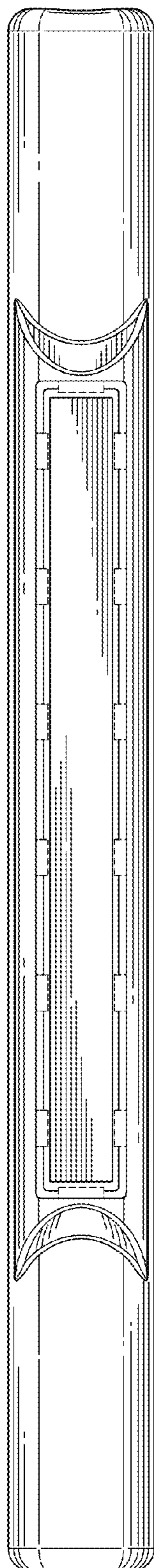

FIG. 2

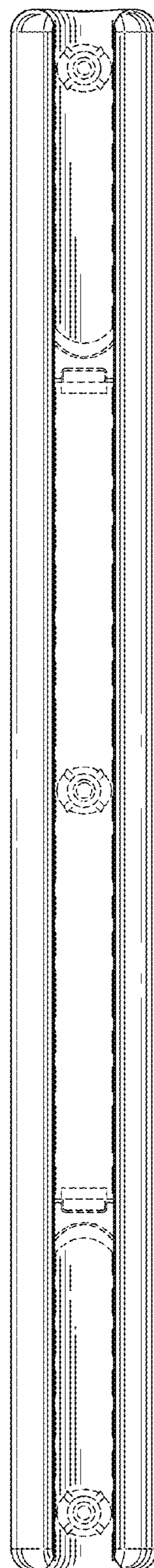

FIG. 3



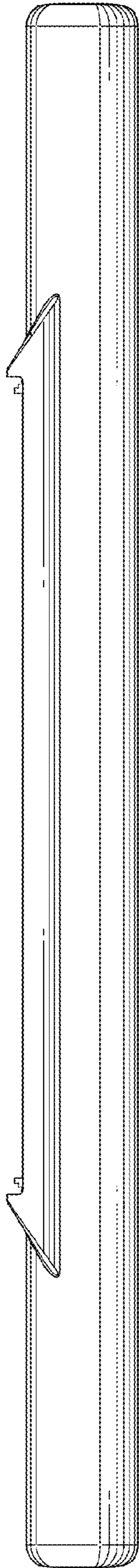

FIG. 4

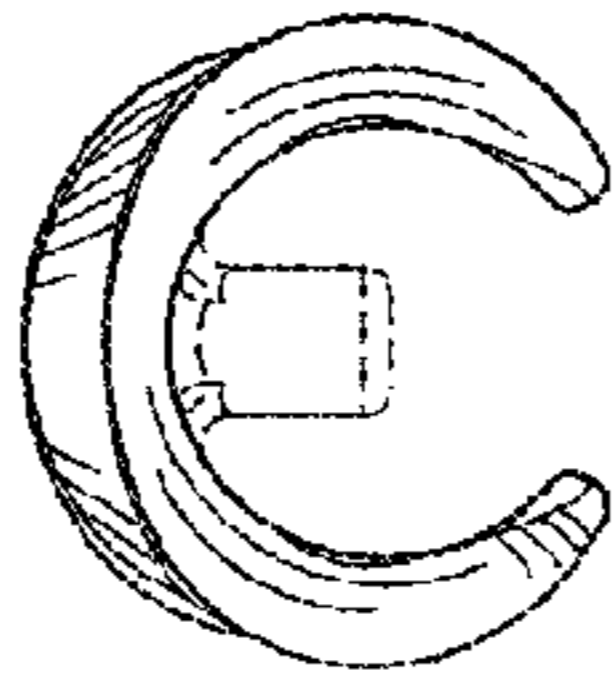

FIG. 5

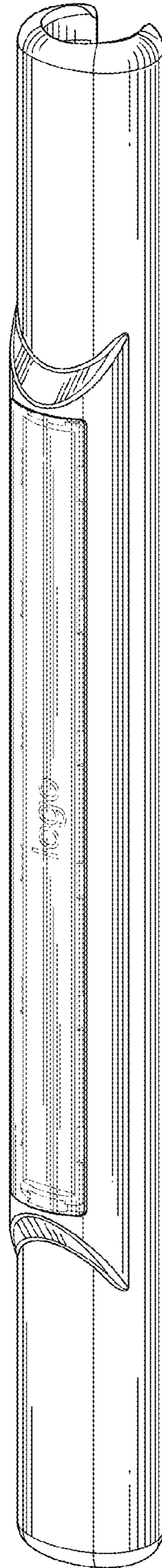

FIG. 6

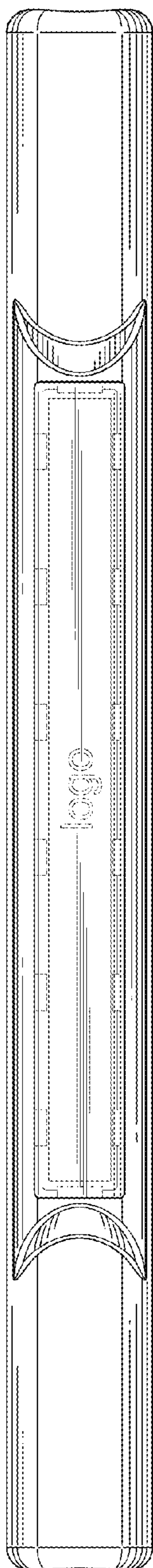

FIG. 7

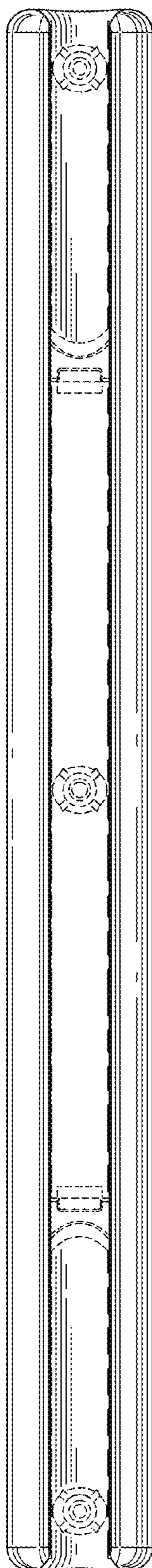

FIG. 8

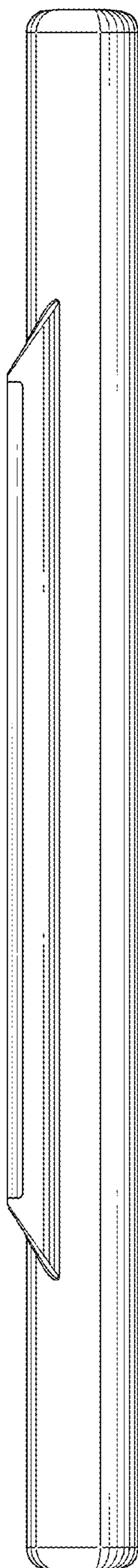

FIG. 9

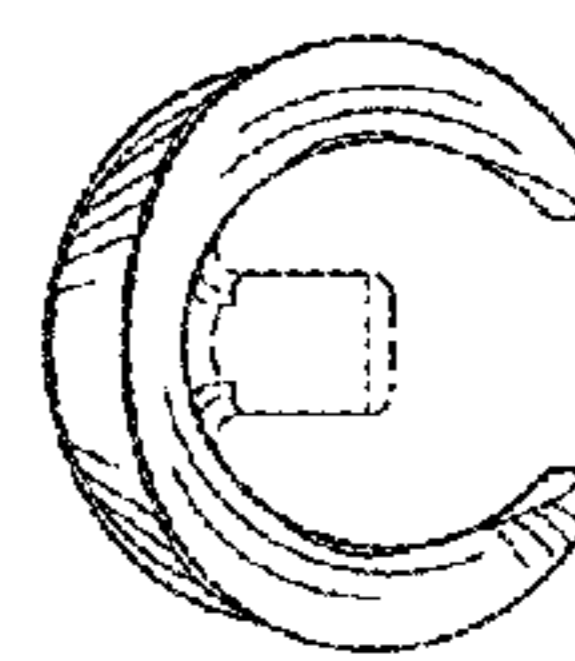

FIG. 10

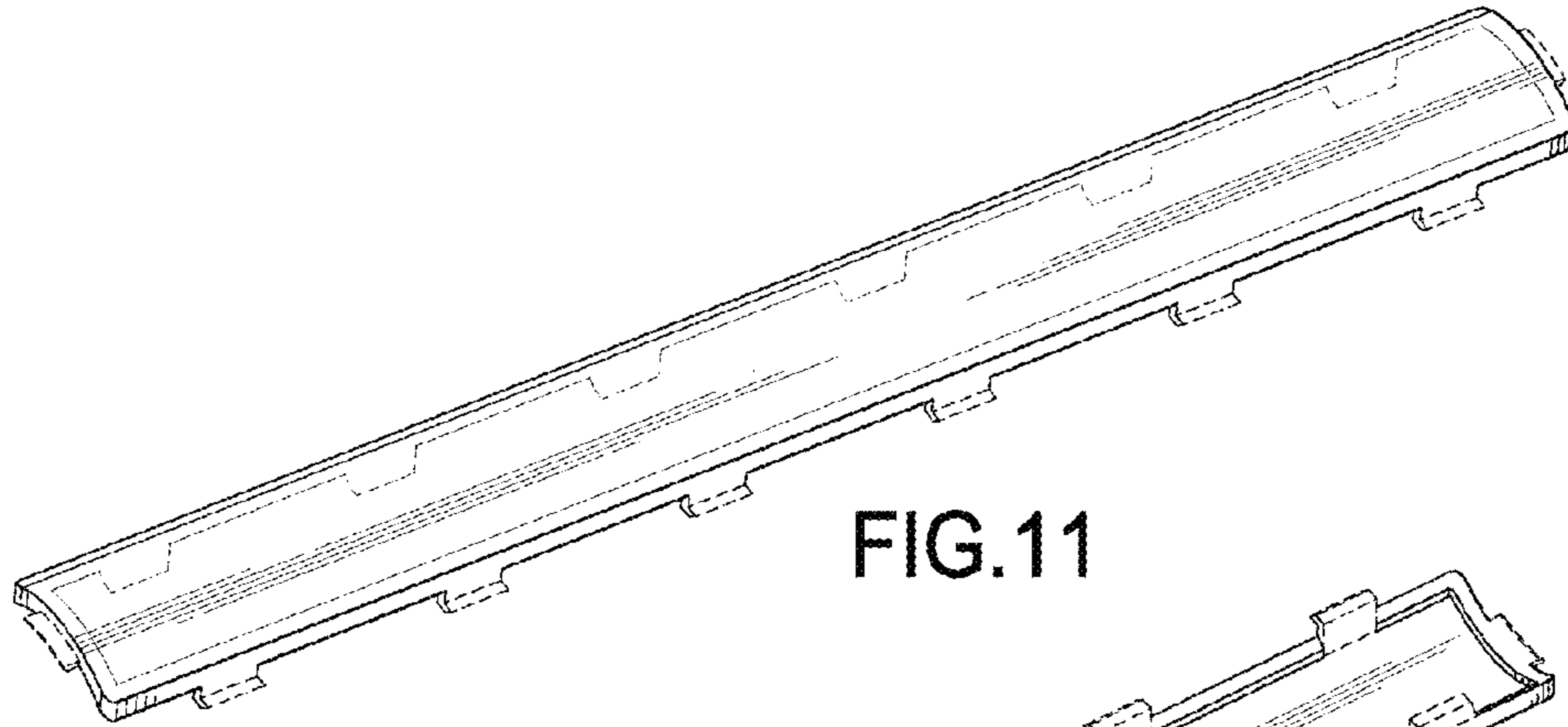

FIG. 11

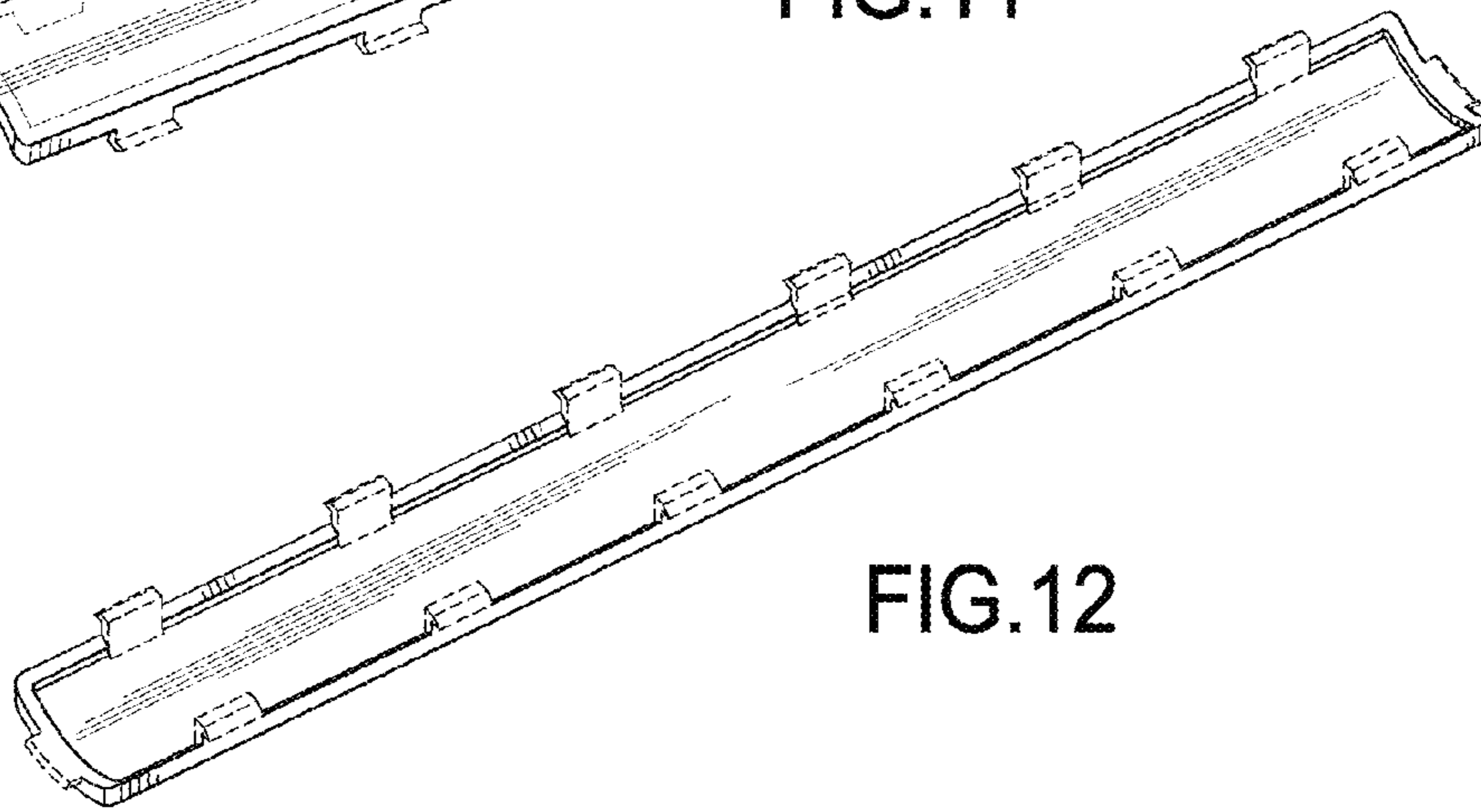

FIG. 12

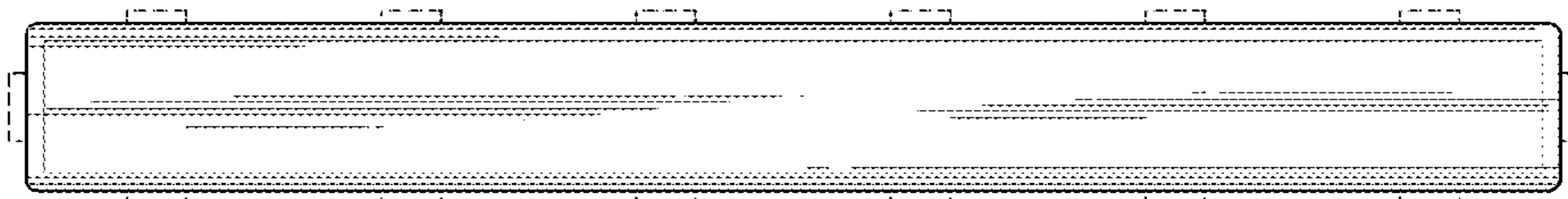

FIG. 13

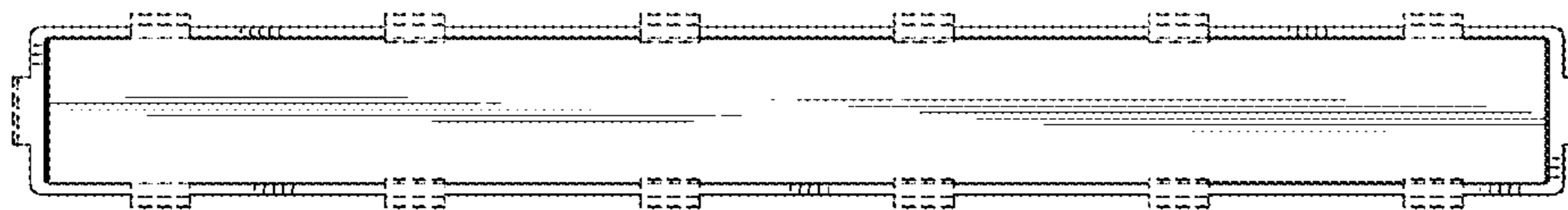

FIG. 14

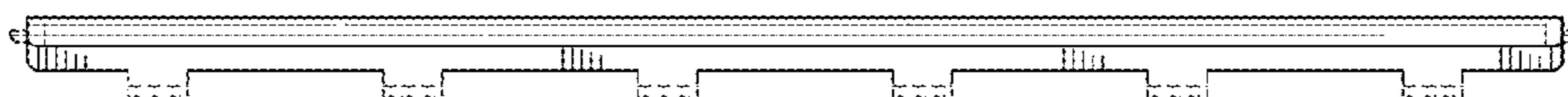

FIG. 15

FIG. 16

