



US00D706940S

(12) **United States Design Patent**
Julian et al.

(10) **Patent No.:** **US D706,940 S**
(45) **Date of Patent:** **** Jun. 10, 2014**

(54) **ORTHOPEDIC PRESSURE PAD**
(75) Inventors: **Dominic J. Julian**, Loveland, OH (US);
Jeremy J. Jacobs, Elsmere, KY (US)
(73) Assignee: **3M Innovative Properties Company**,
St. Paul, MN (US)
(**) Term: **14 Years**

D570,488 S * 6/2008 Kirksey et al. D24/189
D574,962 S * 8/2008 Atkins et al. D24/189
D580,640 S * 11/2008 Wurzburg D2/961
D612,504 S * 3/2010 Ha et al. D24/189
D632,881 S * 2/2011 Rosenberg D2/961
2007/0169378 A1 7/2007 Sodeberg
2008/0066272 A1 3/2008 Hammerslag
2009/0163840 A1* 6/2009 Chiang 602/5
2012/0238927 A1* 9/2012 Chiang 602/26

(21) Appl. No.: **29/424,976**
(22) Filed: **Jun. 18, 2012**
(51) **LOC (10) Cl.** **24-01**
(52) **U.S. Cl.**
USPC **D24/190**
(58) **Field of Classification Search**
USPC D24/189, 190, 192; 602/26, 23, 5, 42,
602/75; 2/910, 24; D29/100, 121.1
See application file for complete search history.

FOREIGN PATENT DOCUMENTS

JP 2002-291956 10/2002
WO 2012-003396 1/2012

* cited by examiner

Primary Examiner — Eric Goodman
Assistant Examiner — Jennifer Watkins
(74) *Attorney, Agent, or Firm* — Irina Hass

(57) **CLAIM**

The ornamental design for an orthopedic pressure pad, as shown and described.

(56) **References Cited**

U.S. PATENT DOCUMENTS

3,052,236 A * 9/1962 Schrieber 602/13
D232,496 S * 8/1974 Rawlings D29/120.1
4,370,978 A 2/1983 Palumbo
4,466,428 A * 8/1984 McCoy 602/26
D402,424 S * 12/1998 Jackson D29/122
5,865,782 A 2/1999 Fareed
D406,677 S * 3/1999 Koschmann et al. D29/121.1
6,080,124 A 6/2000 Falk
D462,772 S * 9/2002 Lamping et al. D24/190
6,485,448 B2 11/2002 Lamping
D472,679 S * 4/2003 Burington D29/121.1
6,641,549 B2 11/2003 Darcey
6,755,800 B2 6/2004 Weaver, II
D516,727 S * 3/2006 Neri D24/189
D548,350 S * 8/2007 Jordan et al. D24/190

DESCRIPTION

FIG. 1 is a perspective view of an orthopedic pressure pad showing the new design;
FIG. 2 is another perspective view thereof;
FIG. 3 is a side view thereof, the opposing side being a mirror image thereof;
FIG. 4 is a top view thereof;
FIG. 5 is a bottom view thereof; and,
FIG. 6 is a front view thereof, the opposing side being a mirror image thereof.
The surface shading illustrated in the drawings is provided merely to highlight the contour of design; it is not intended to be illustrative of texture or gloss.

1 Claim, 2 Drawing Sheets

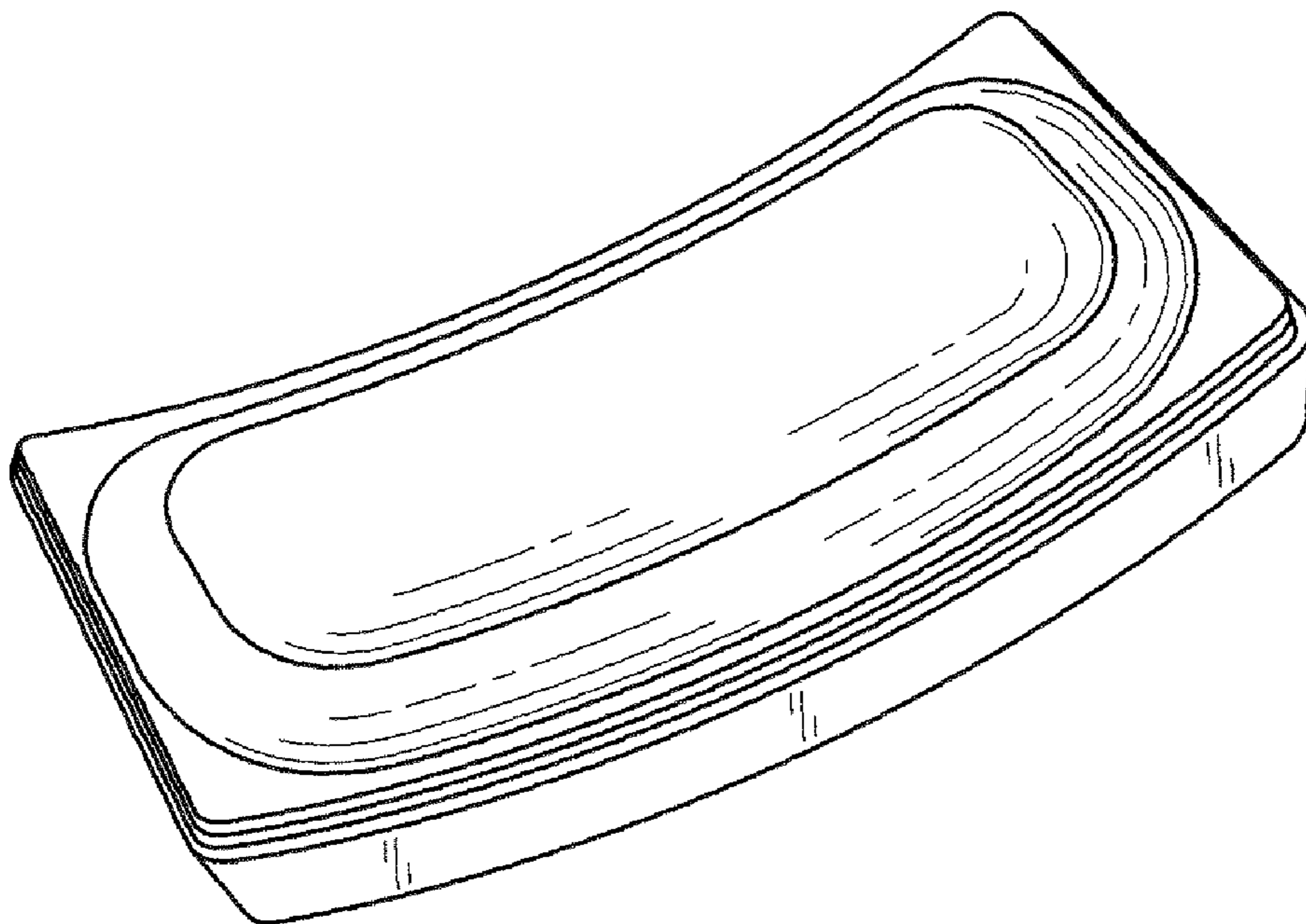

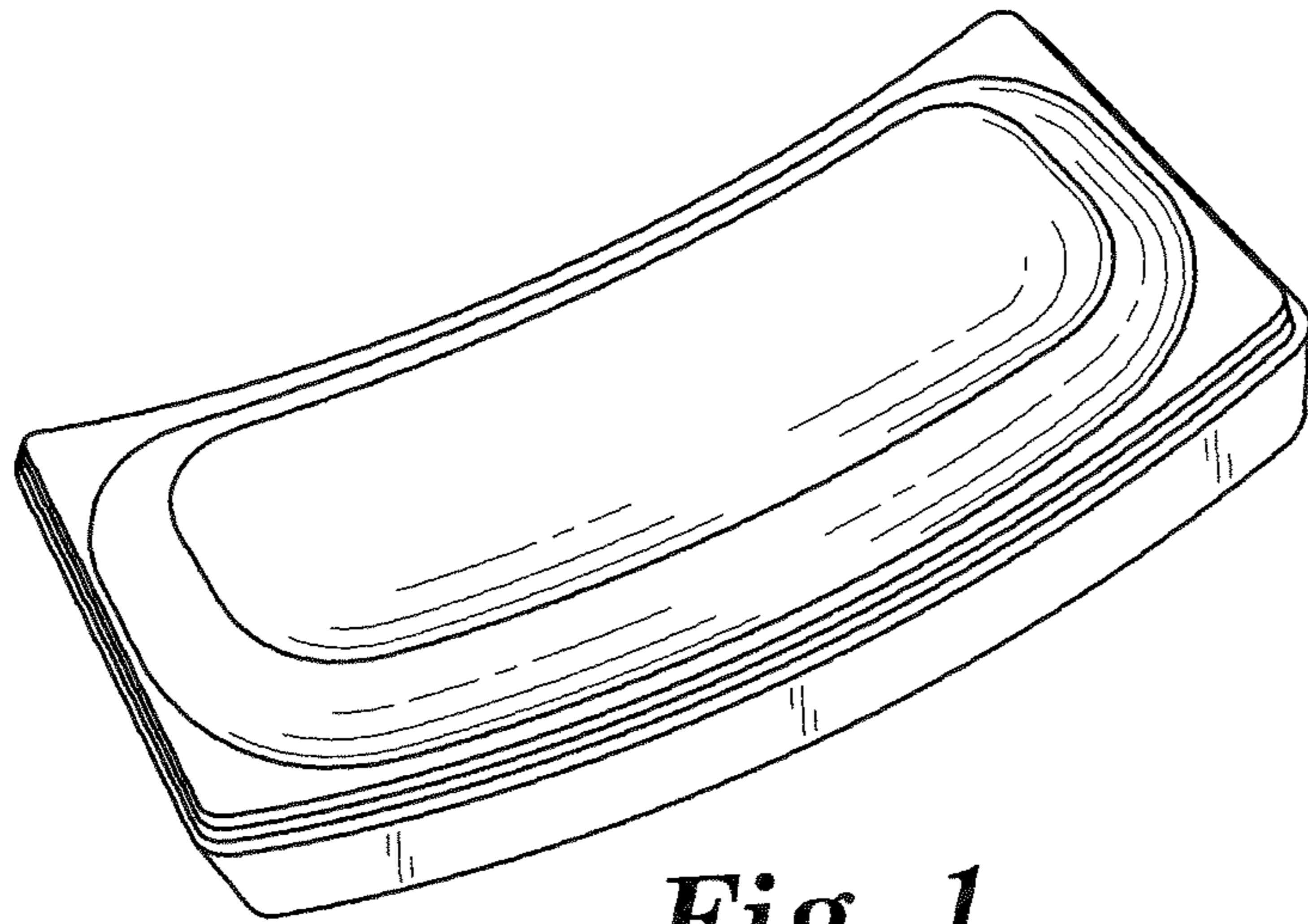

Fig. 1

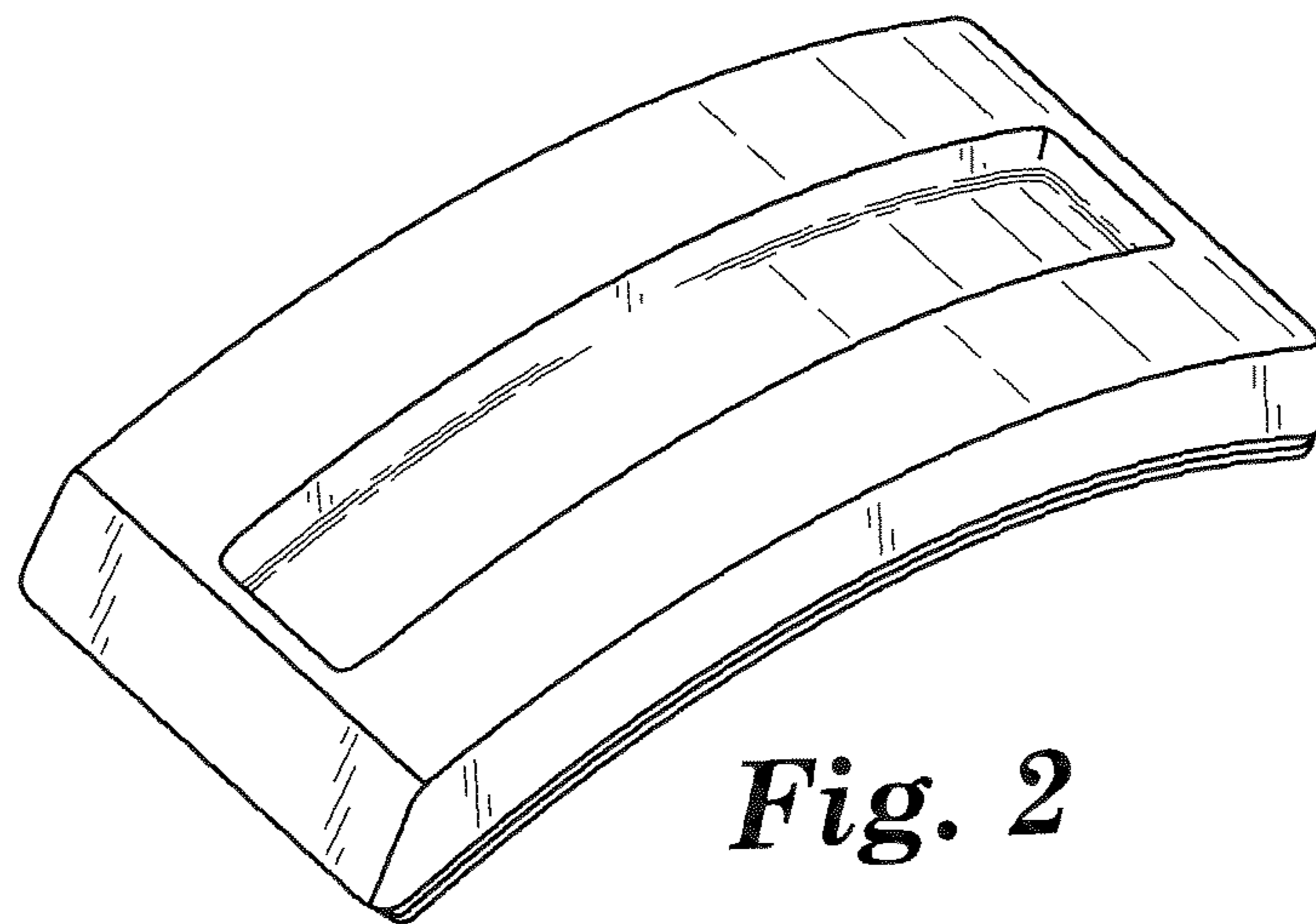

Fig. 2

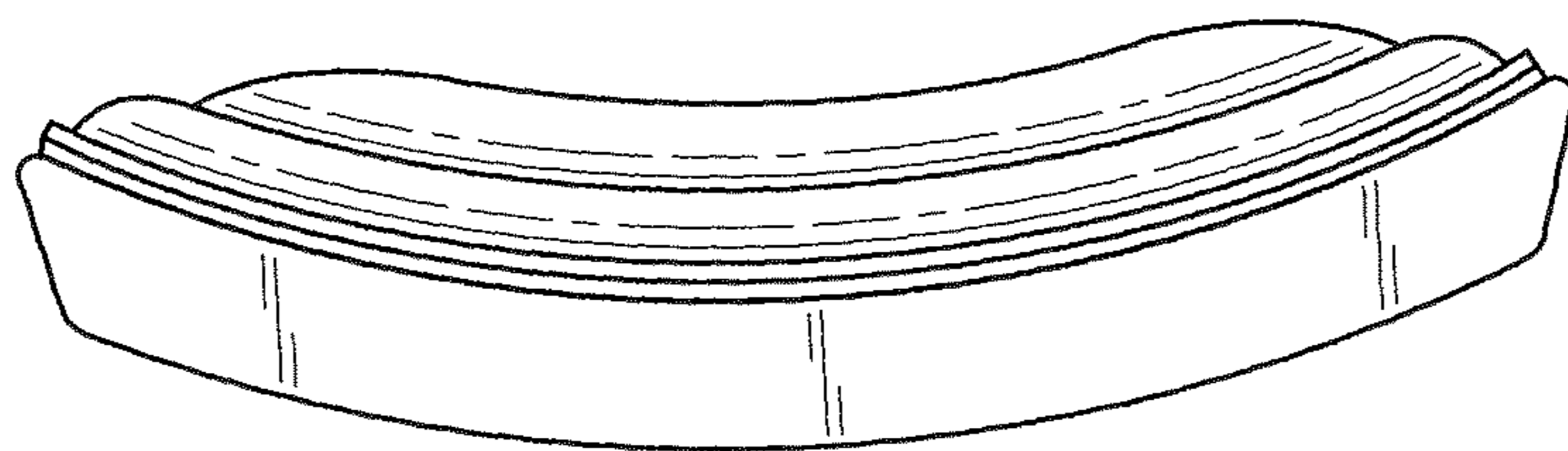

Fig. 3

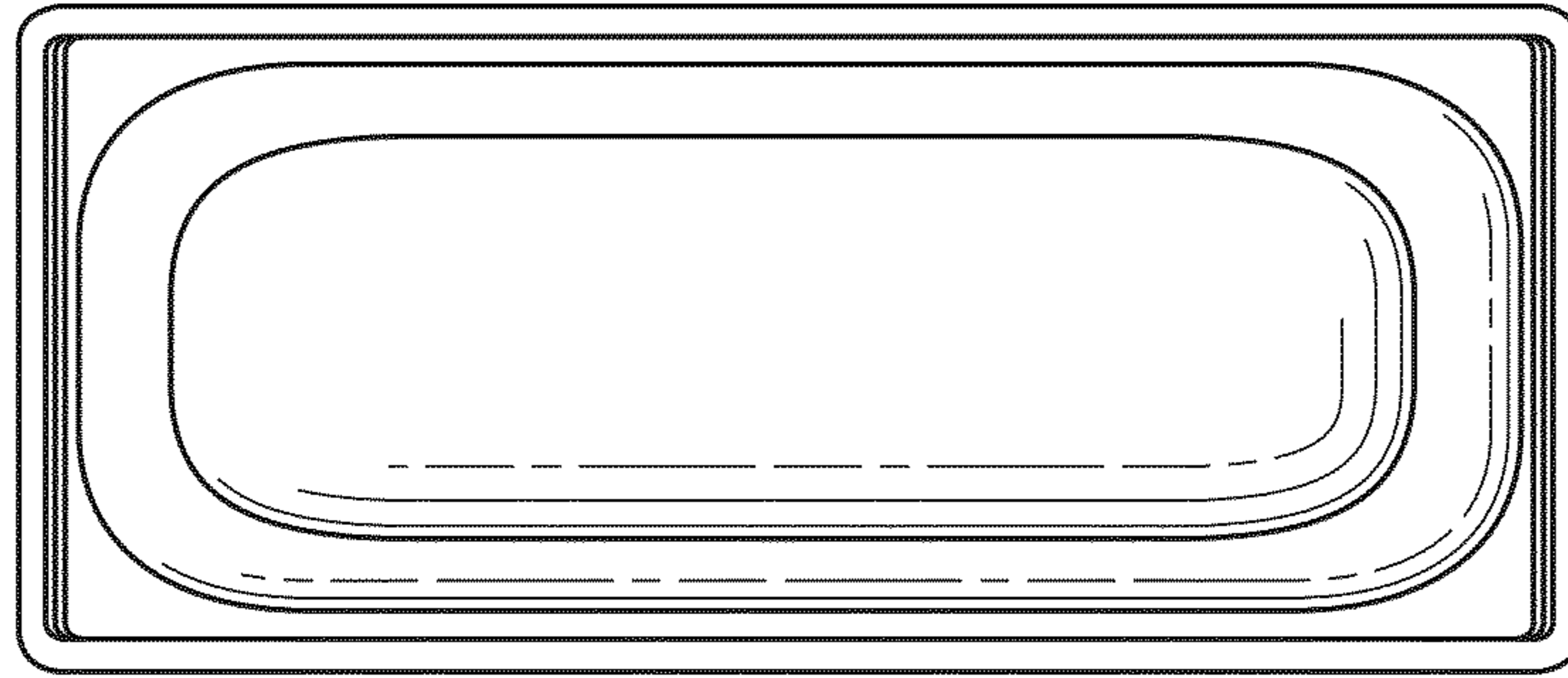

Fig. 4

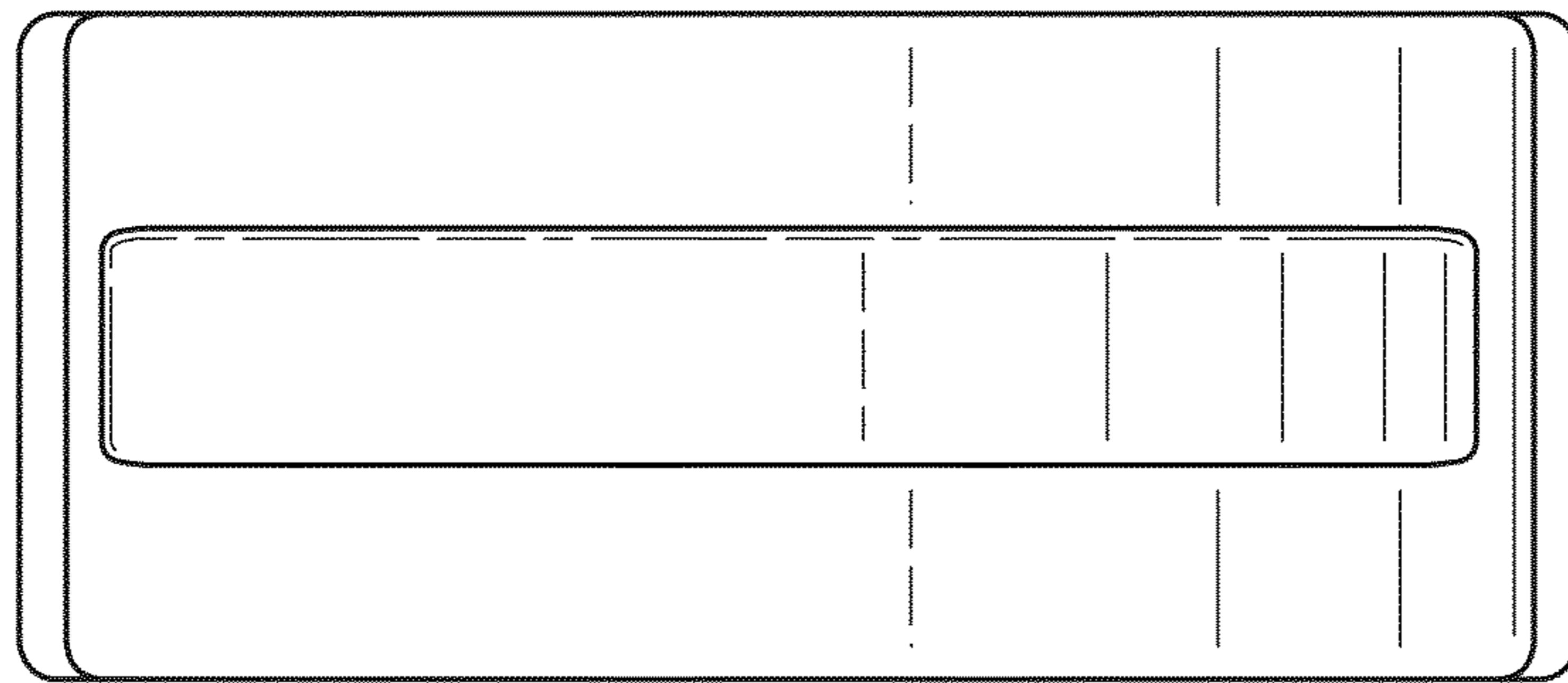

Fig. 5

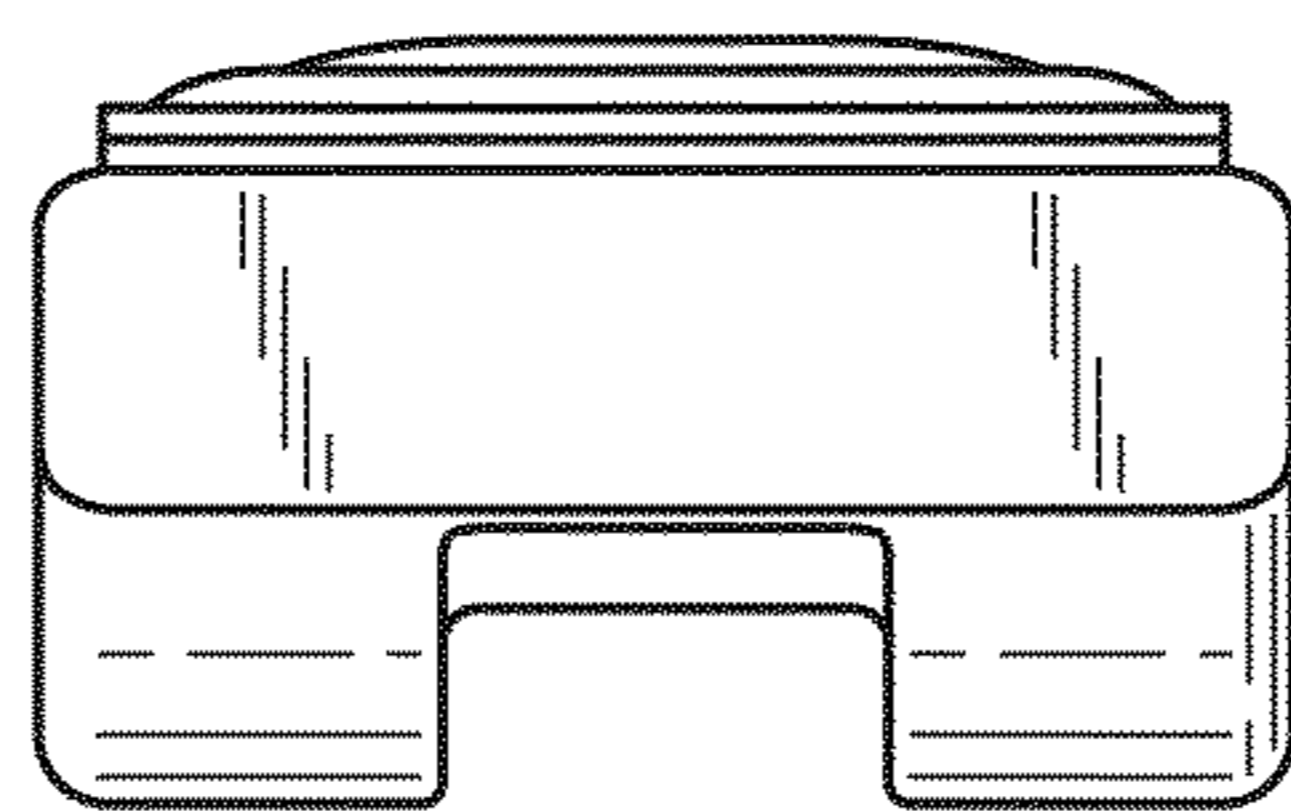

Fig. 6