



US00D706908S

(12) **United States Design Patent**
Knapp

(10) **Patent No.:** **US D706,908 S**
(45) **Date of Patent:** **** Jun. 10, 2014**

(54) **GASKET**

(75) Inventor: **Mark Knapp**, Ravenna, OH (US)

(73) Assignee: **SpringSeal, Inc.**, Streetsboro, OH (US)

(**) Term: **14 Years**

(21) Appl. No.: **29/419,470**

(22) Filed: **Apr. 27, 2012**

(51) **LOC (10) Cl.** **23-01**

(52) **U.S. Cl.**
USPC **D23/269**

(58) **Field of Classification Search**
USPC D23/269; 137/516.13–516.27; 251/368;
277/602, 608, 625–626; 285/104–105,
285/337

See application file for complete search history.

(56) **References Cited**

U.S. PATENT DOCUMENTS

2,259,940	A *	10/1941	Nathan	277/626
3,379,444	A *	4/1968	Brummer et al.	277/543
D285,247	S *	8/1986	Jornhagen	D23/269
6,299,176	B1 *	10/2001	Guzowski et al.	277/604
6,336,640	B1	1/2002	Knapp		
6,367,802	B1	4/2002	Knapp		
6,550,775	B2	4/2003	Knapp		
7,469,905	B2	12/2008	Knapp		
7,513,536	B2 *	4/2009	Corbett et al.	285/374
7,594,664	B2 *	9/2009	Maskaliunas	277/551
7,731,884	B2	6/2010	Knapp et al.		
7,753,376	B2 *	7/2010	Kondo et al.	277/353
D631,948	S *	2/2011	Yoshida et al.	D23/269
D638,522	S *	5/2011	Yoshida et al.	D23/269
D696,751	S *	12/2013	Beagen, Jr.	D23/269
2008/1030322		12/2008	Knapp		
2009/0206553	A1 *	8/2009	Kanzaki	277/351
2010/0007090	A1 *	1/2010	Kobayashi	277/351

OTHER PUBLICATIONS

Photograph of a gasket similar to the profile shown in U.S. Patent Publication No. 2008/0303224, 1 page. This product as shown and described in the photograph was on sale in the U.S. on or before Apr. 1, 2010.

Photograph of a gasket similar to the profile shown in U.S. Patent No. 6,550,775, 1 page. This product as shown and described in the photograph was on sale in the U.S. on or before Apr. 1, 2010.

Photograph of a gasket similar to the profile shown in U.S. Patent No. 6,336,640, 1 page. This product as shown and described in the photograph was on sale in the U.S. on or before Apr. 1, 2010.

Photograph of a gasket, 1 page. This product as shown in the photograph was on sale in the U.S. on or before Apr. 1, 2010.

* cited by examiner

Primary Examiner — Eric Goodman

(74) *Attorney, Agent, or Firm* — Tarolli, Sundheim, Covell & Tummino LLP

(57) **CLAIM**

The ornamental design for a gasket, as shown and described.

DESCRIPTION

FIG. 1 is a front perspective view of a gasket showing the ornamental design in accordance with a first embodiment of the present disclosure;

FIG. 2 is a rear perspective view thereof;

FIG. 3 is a front view thereof;

FIG. 4 is a side elevation view thereof;

FIG. 5 is a partial sectioned perspective view of FIG. 1;

FIG. 6 is a cross-sectional view of FIG. 5 along lines 6-6, the cross sectional-view indicating colors associated with the first embodiment;

FIG. 7 is a front perspective view of a gasket showing the ornamental design in accordance with a second embodiment of the present disclosure;

FIG. 8 is a rear perspective view thereof;

FIG. 9 is a front view thereof;

FIG. 10 is a side elevation view thereof;

FIG. 11 is a partial sectioned perspective view of FIG. 7;

FIG. 12 is a cross-sectional view of FIG. 11 along lines 12-12, the cross-sectional view indicating colors associated with the second embodiment;

FIG. 13 is a front perspective view of a gasket showing the ornamental design in accordance with a third embodiment of the present disclosure;

FIG. 14 is a rear perspective view thereof;

FIG. 15 is a front view thereof;

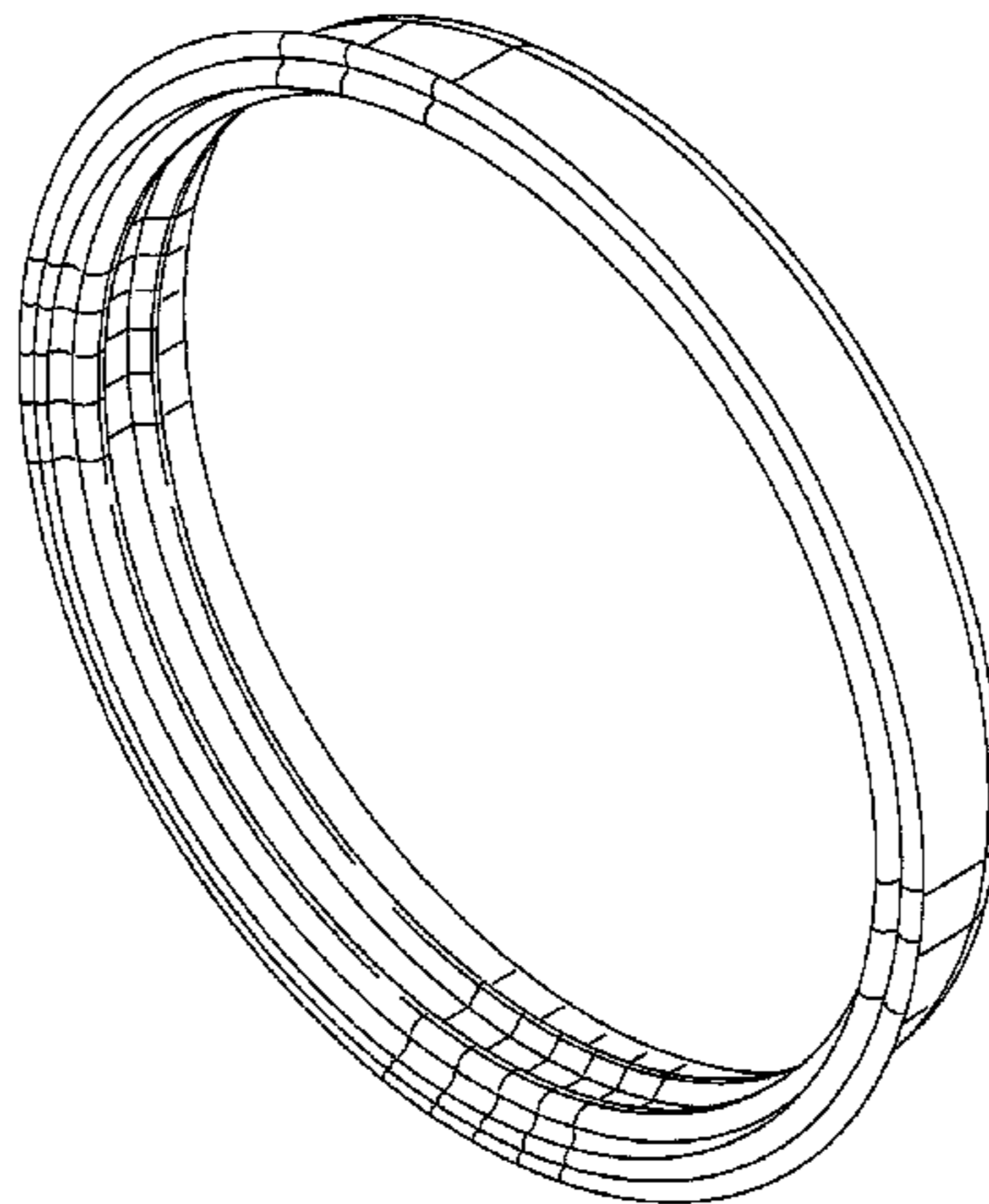

FIG. 16 is a side elevation view thereof;
FIG. 17 is a partial sectioned perspective view of FIG. 13;
FIG. 18 is a cross-sectional view of FIG. 17 along lines 18-18, the cross-sectional view indicating colors associated with the third embodiment;
FIG. 19 is a front perspective view of a gasket showing the ornamental design in accordance with a fourth embodiment of the present disclosure;
FIG. 20 is a rear perspective view thereof;
FIG. 21 is a front view thereof;
FIG. 22 is a side elevation view thereof;
FIG. 23 is a partial sectioned perspective view of FIG. 19;
FIG. 24 is a cross-sectional view of FIG. 23 along lines 24-24, the cross-sectional view indicating colors associated with the fourth embodiment;
FIG. 25 is a front perspective view of a gasket showing the ornamental design in accordance with a fifth embodiment of the present disclosure;
FIG. 26 is a rear perspective view thereof;
FIG. 27 is a front view thereof;
FIG. 28 is a side elevation view thereof;
FIG. 29 is a partial sectioned perspective view of FIG. 25;
FIG. 30 is a cross-sectional view of FIG. 29 along lines 30-30, the cross-sectional view indicating colors associated with the fifth embodiment;
FIG. 31 is a front perspective view of a gasket showing the ornamental design in accordance with a sixth embodiment of the present disclosure;
FIG. 32 is a rear perspective view thereof;
FIG. 33 is a front view thereof;
FIG. 34 is a side elevation view thereof;
FIG. 35 is a partial sectioned perspective view of FIG. 31;
FIG. 36 is a cross-sectional view of FIG. 35 along lines 36-36, the cross-sectional view indicating colors associated with the sixth embodiment;

FIG. 37 is a front perspective view of a gasket showing the ornamental design in accordance with a seventh embodiment of the present disclosure;
FIG. 38 is a rear perspective view thereof;
FIG. 39 is a front view thereof;
FIG. 40 is a side elevation view thereof;
FIG. 41 is a partial sectioned perspective view of FIG. 37;
FIG. 42 is a cross-sectional view of FIG. 41 along lines 42-42, the cross-sectional view indicating colors associated with the seventh embodiment;
FIG. 43 is a front perspective view of a gasket showing the ornamental design in accordance with an eighth embodiment of the present disclosure;
FIG. 44 is a rear perspective view thereof;
FIG. 45 is a front view thereof;
FIG. 46 is a side elevation view thereof;
FIG. 47 is a partial sectioned perspective view of FIG. 43;
FIG. 48 is a cross-sectional view of FIG. 47 along lines 48-48, the cross-sectional view indicating colors associated with the eighth embodiment;
FIG. 49 is a front perspective view of a gasket showing the ornamental design in accordance with a ninth embodiment of the present disclosure;
FIG. 50 is a rear perspective view thereof;
FIG. 51 is a front view thereof;
FIG. 52 is a side elevation view thereof;
FIG. 53 is a partial sectioned perspective view of FIG. 49;
and,
FIG. 54 is a cross-sectional view of FIG. 53 along lines 54-54, the cross-sectional view indicating a color and translucent property associated with the ninth embodiment.
Those portions of the Figures shown in broken lines are included for environmental purposes only and form no part of the claimed design.

1 Claim, 45 Drawing Sheets

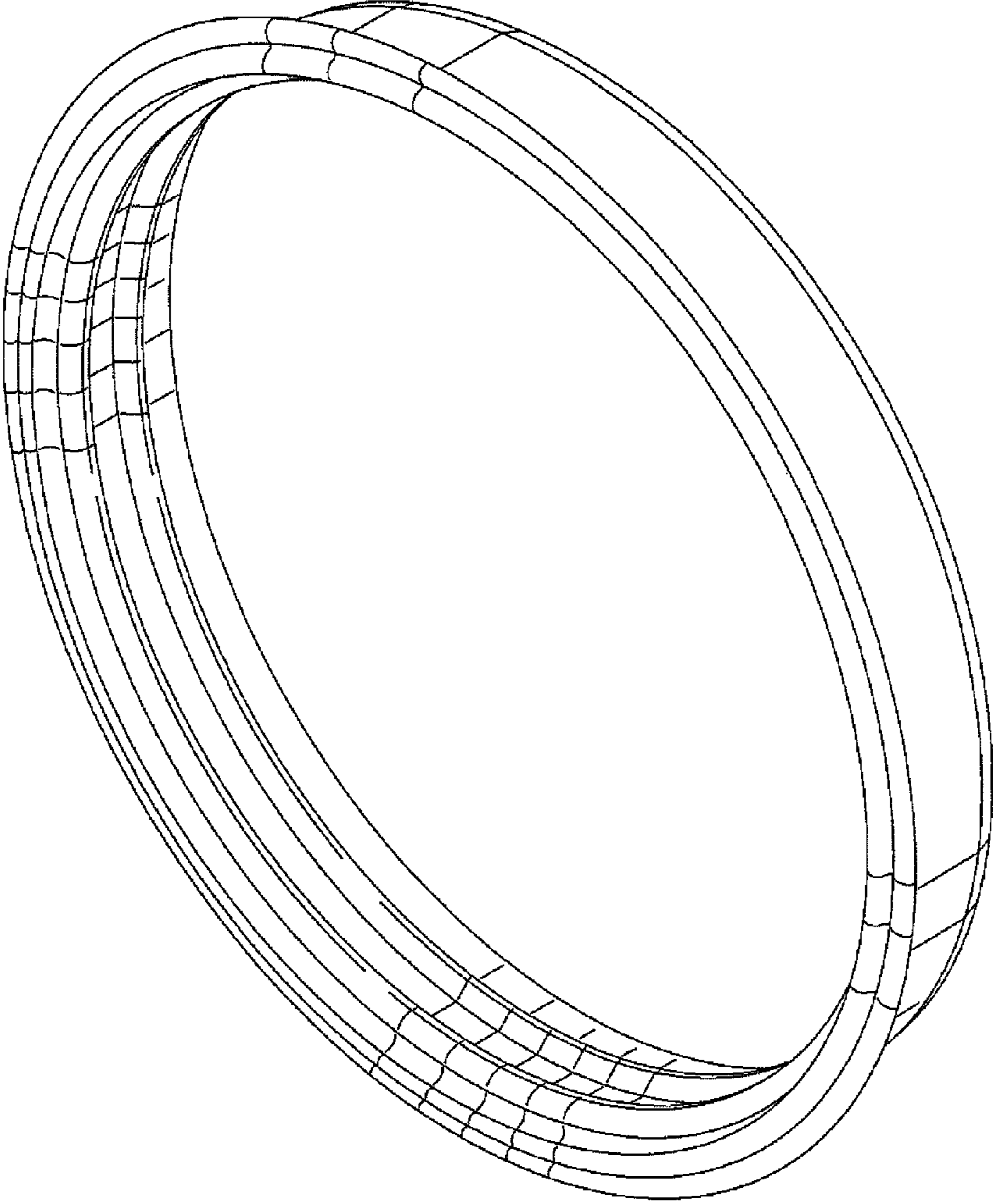

FIG. 1

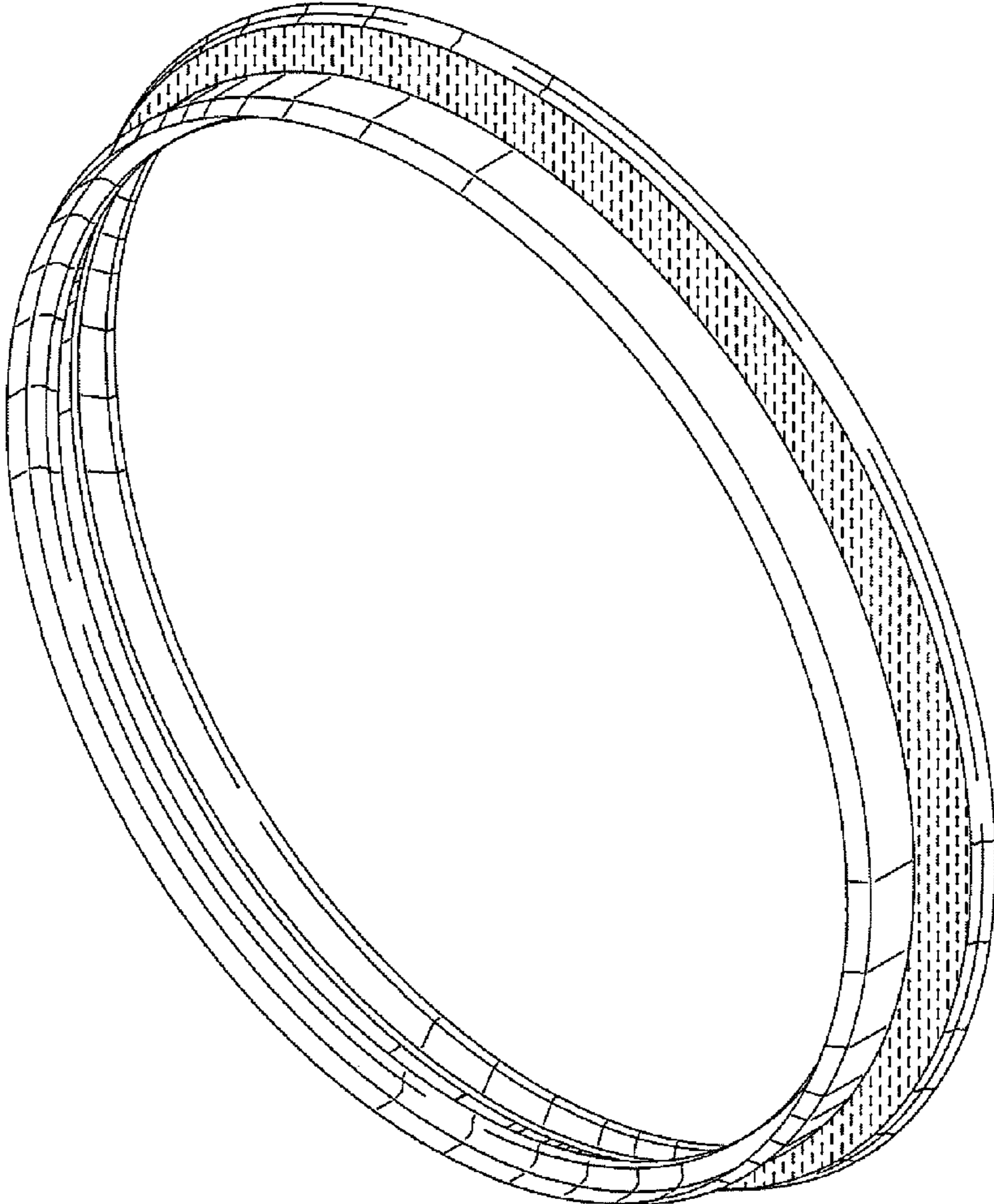

FIG. 2

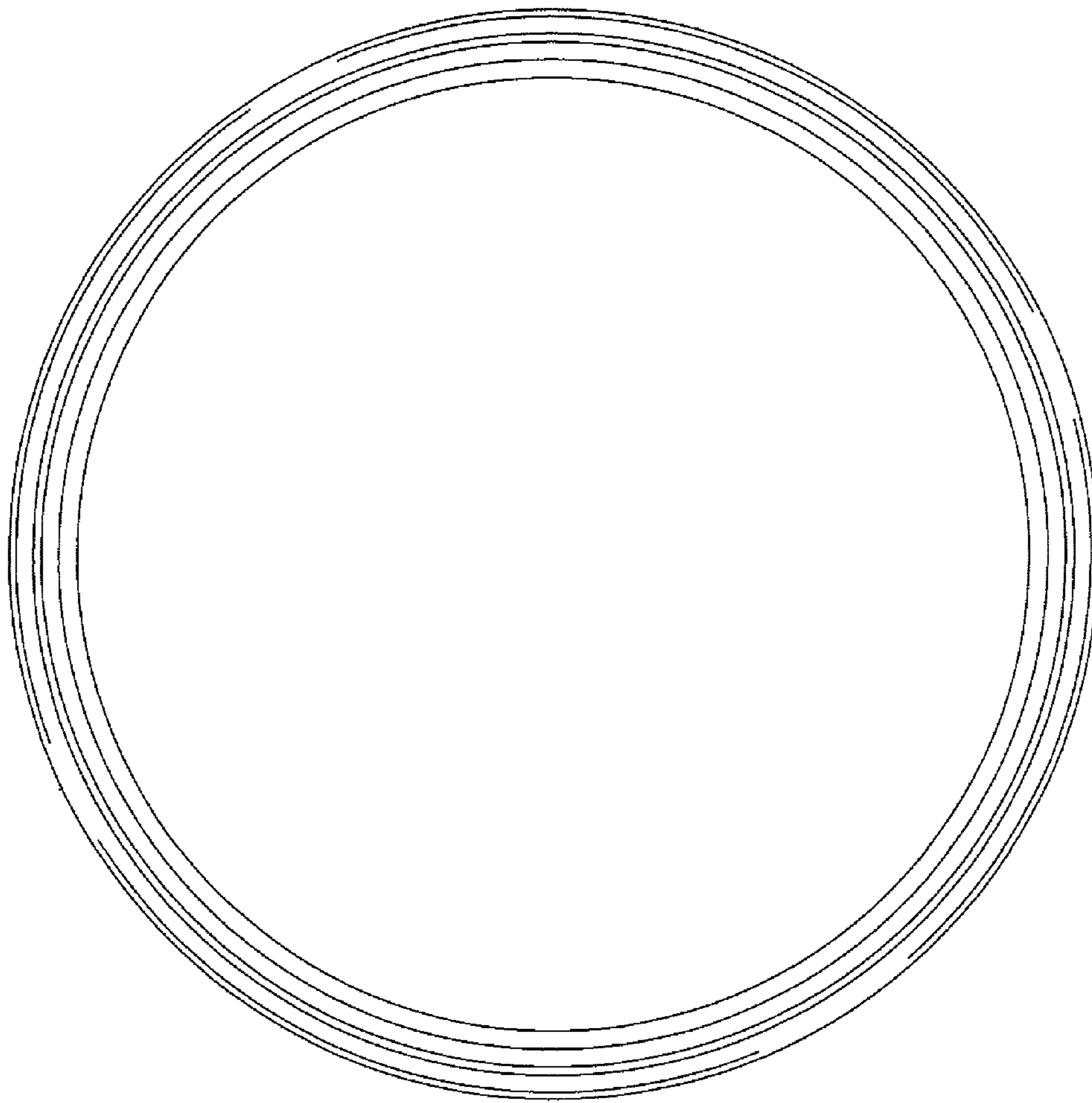

FIG. 3

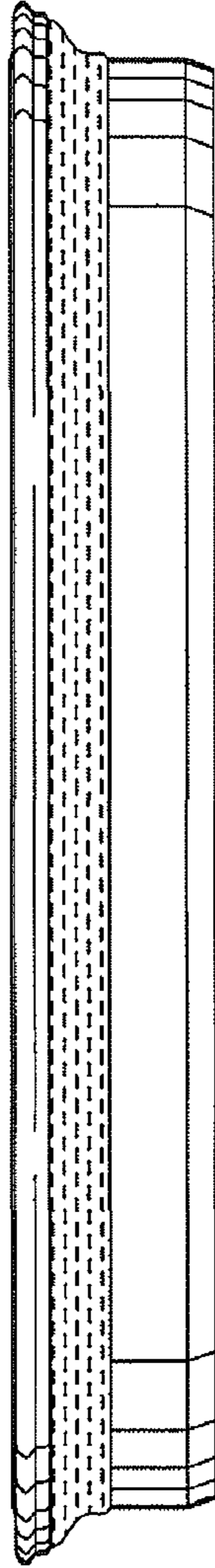

FIG. 4

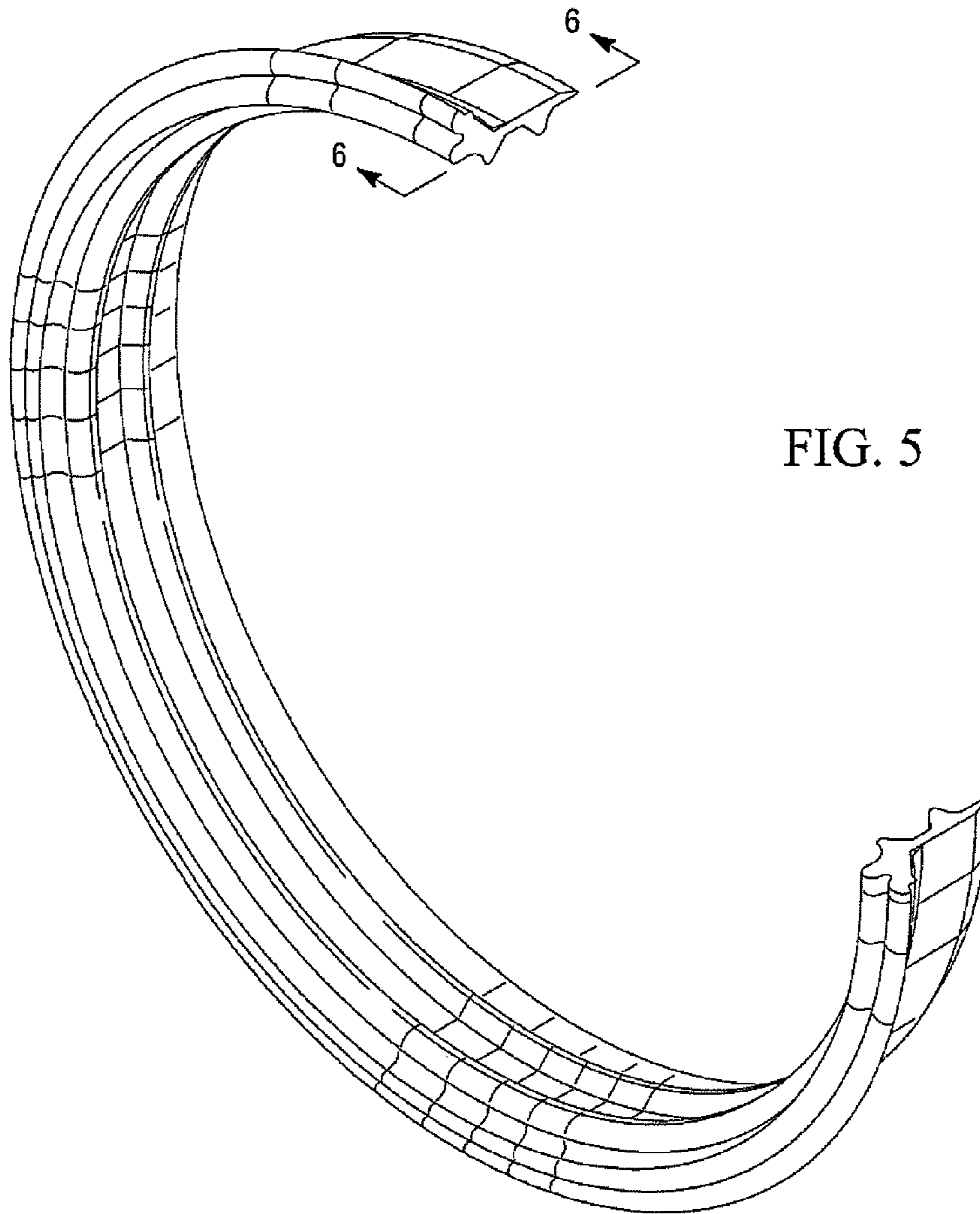

FIG. 5

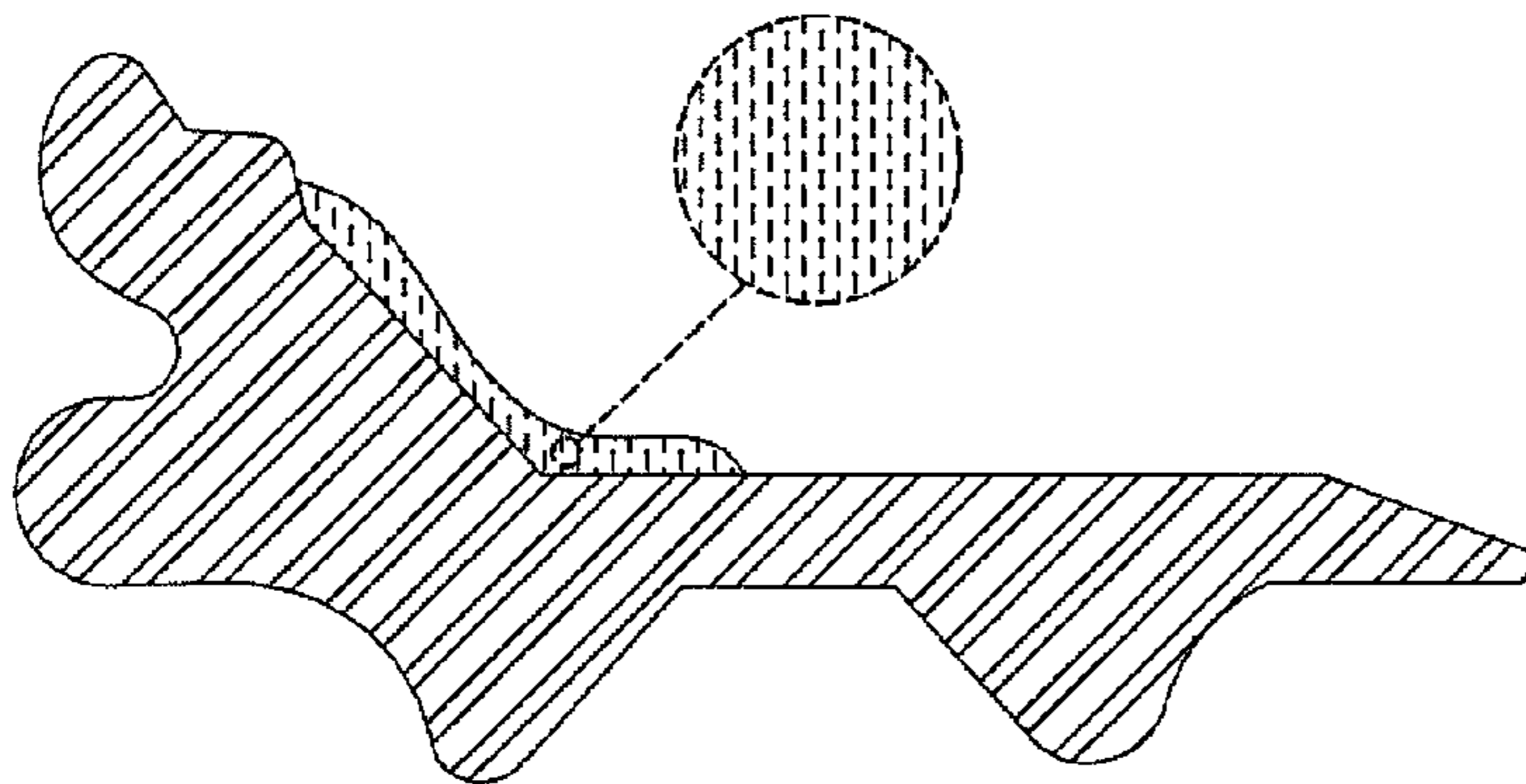

FIG. 6

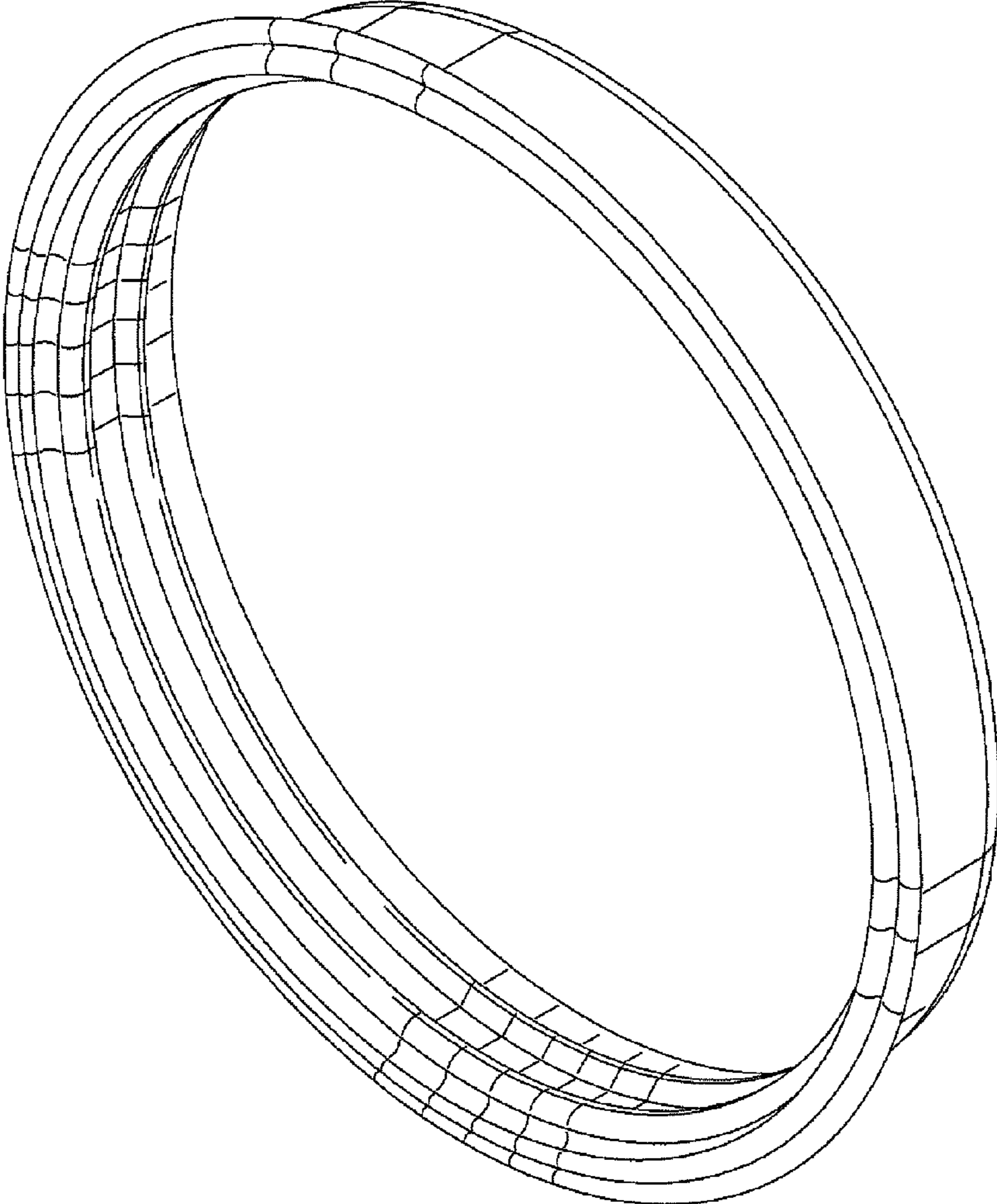

FIG. 7

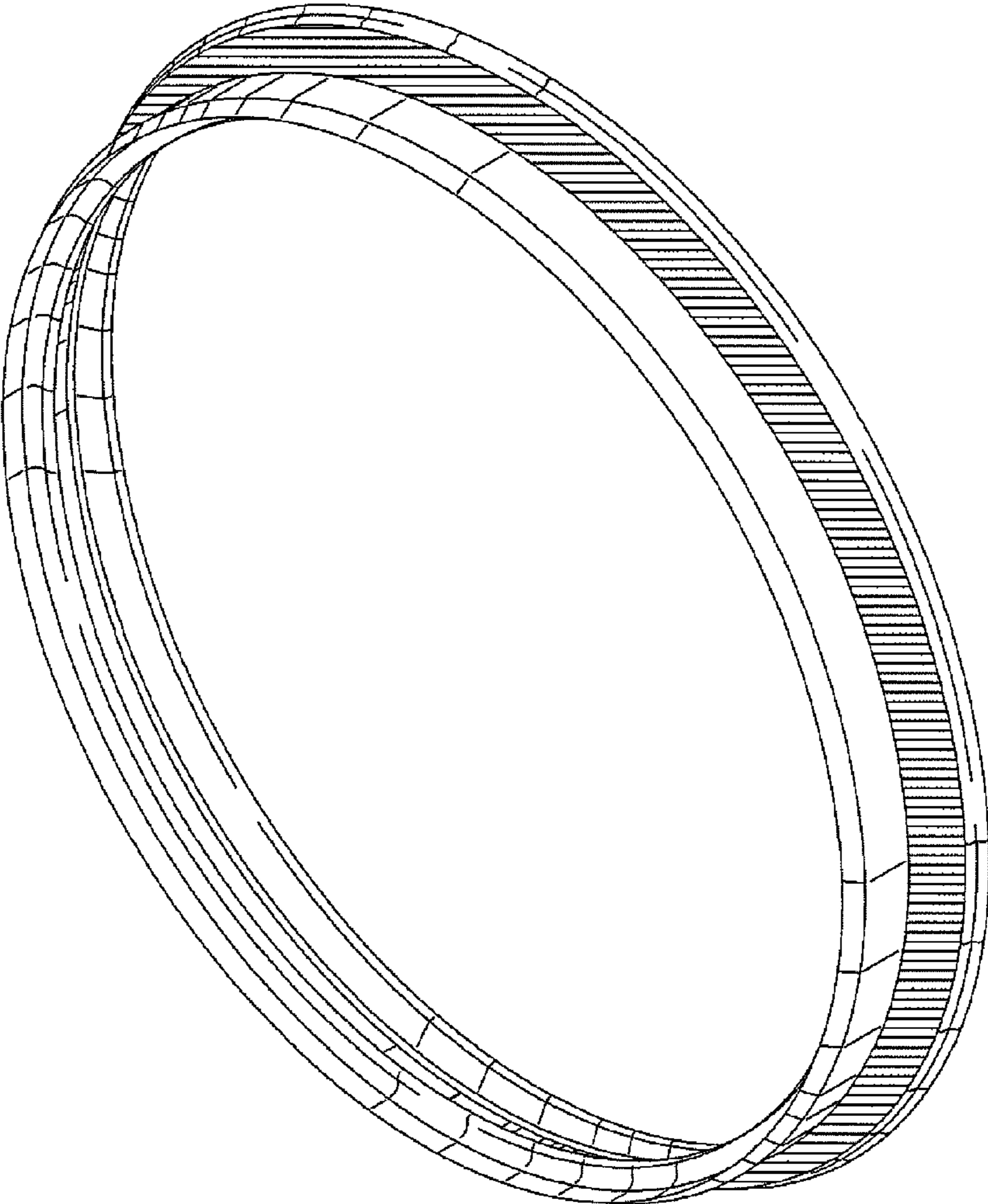

FIG. 8

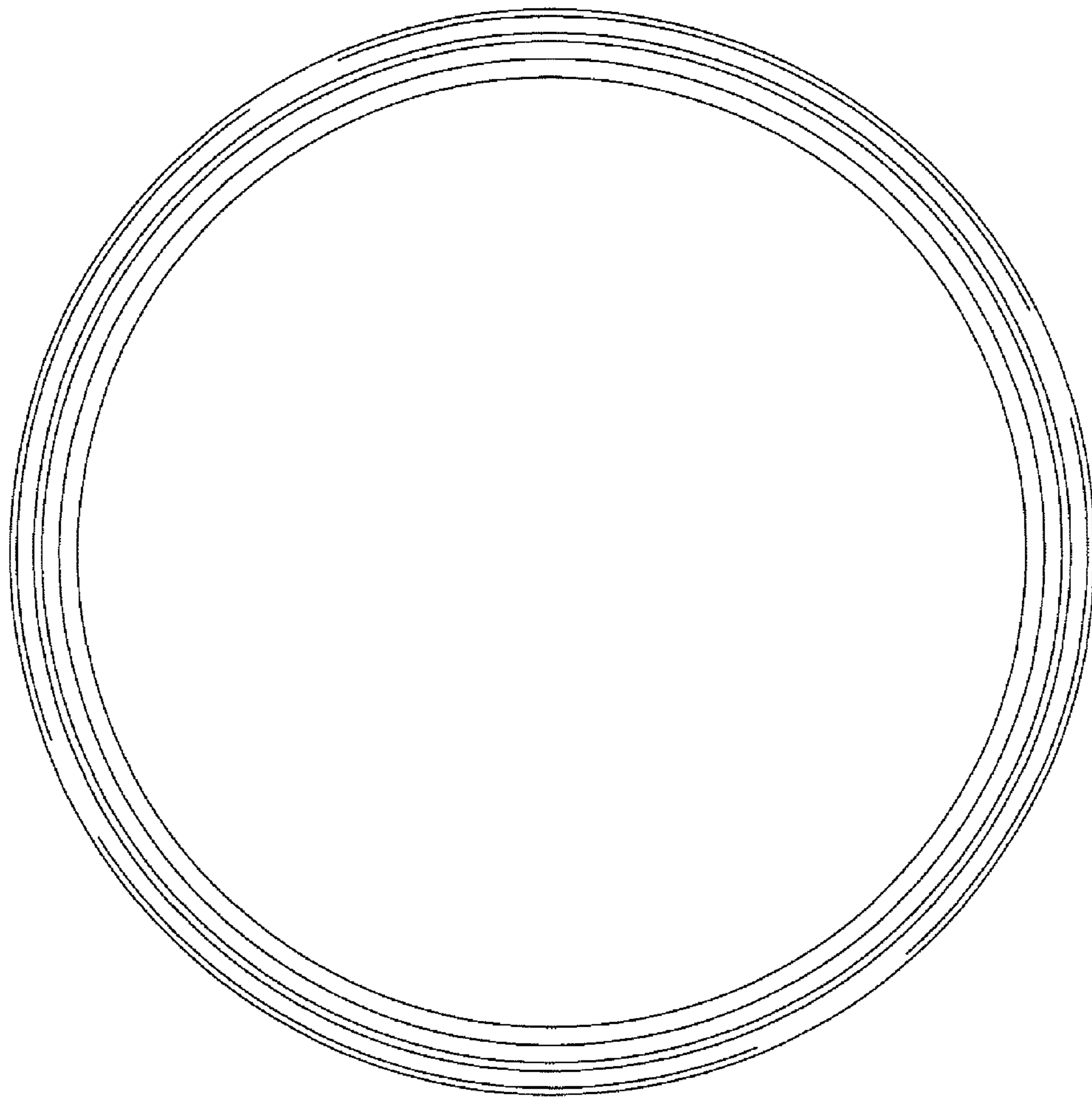

FIG. 9

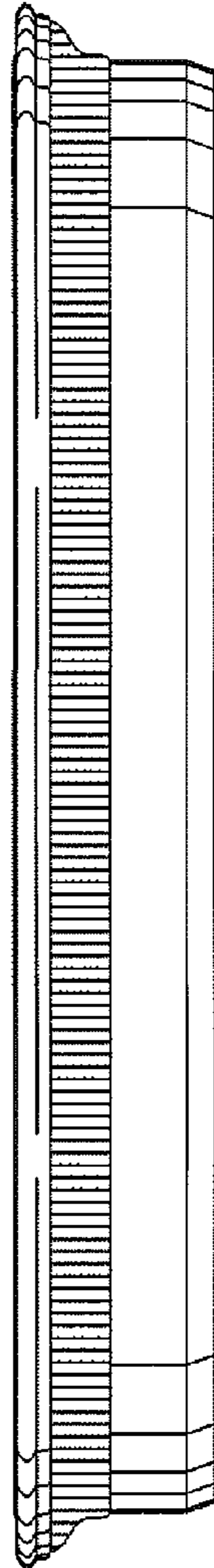

FIG. 10

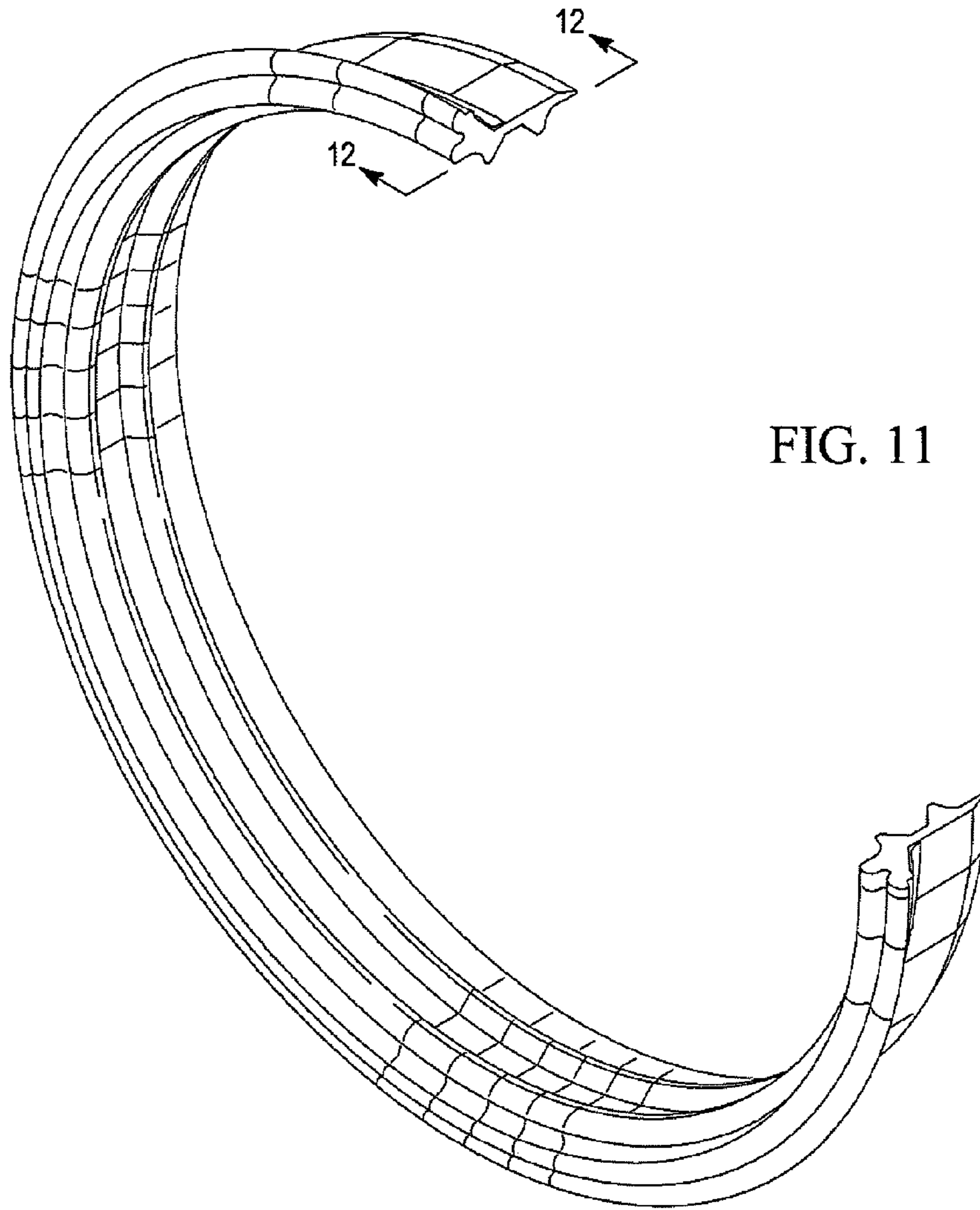

FIG. 11

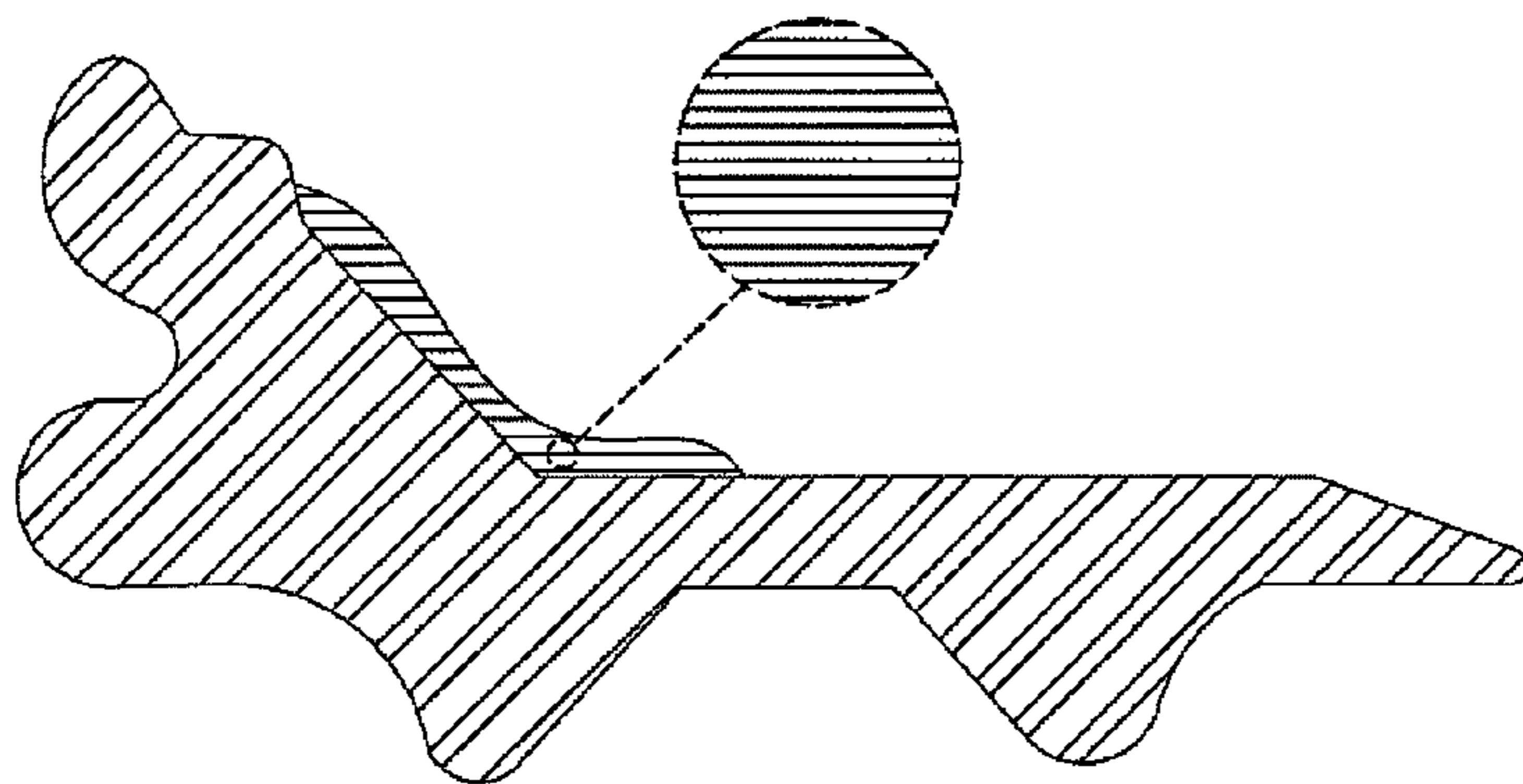

FIG. 12

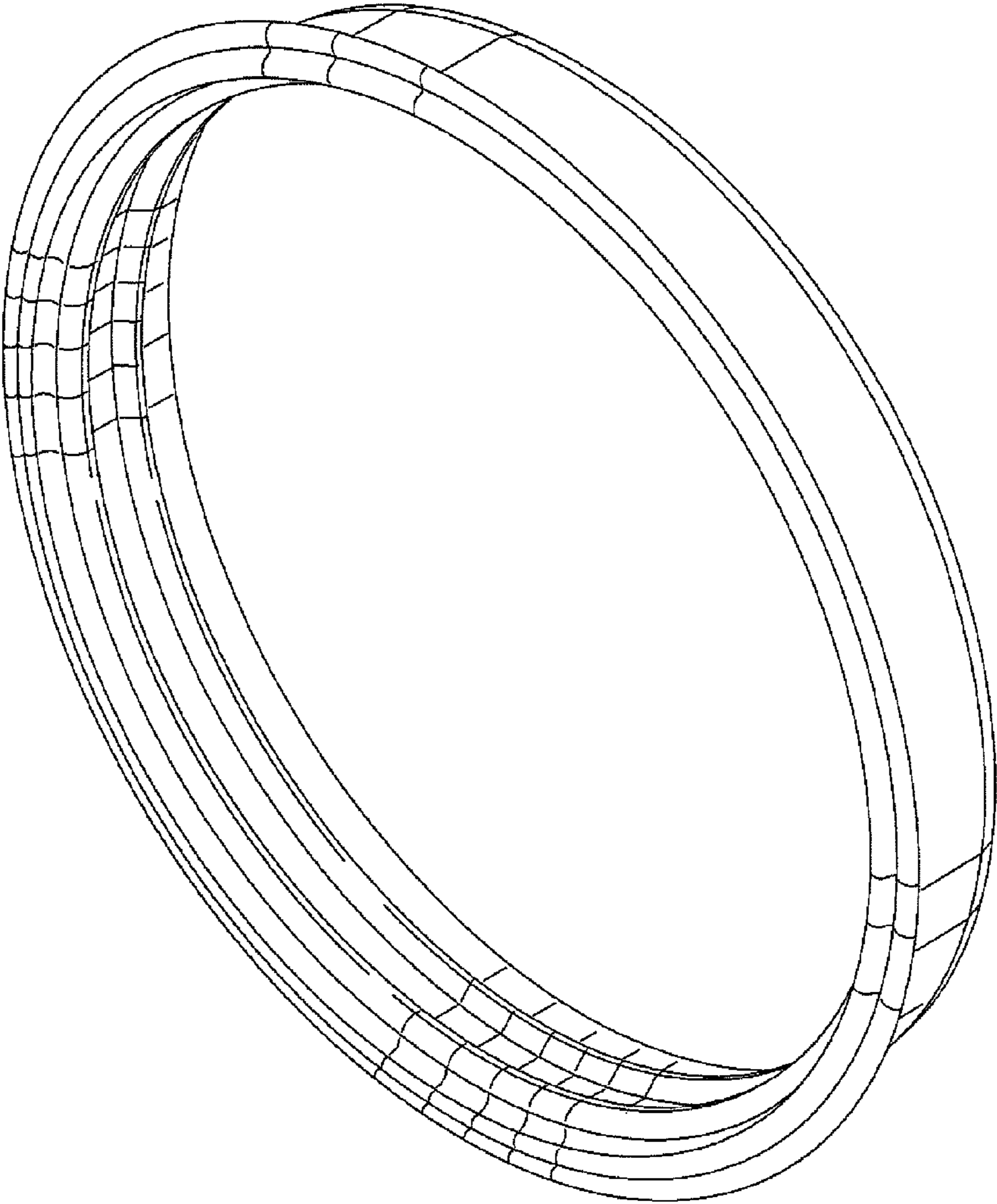

FIG. 13

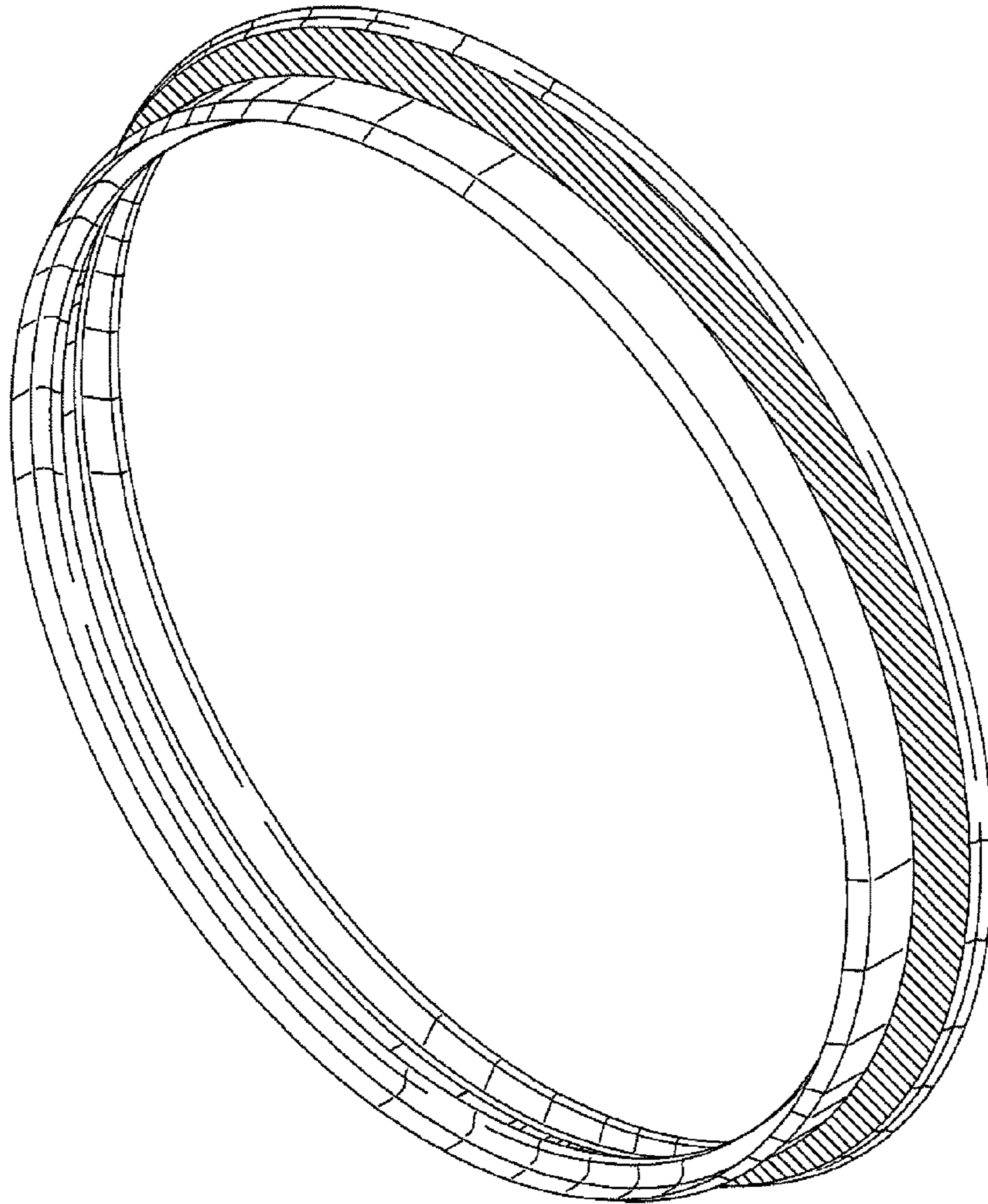

FIG. 14

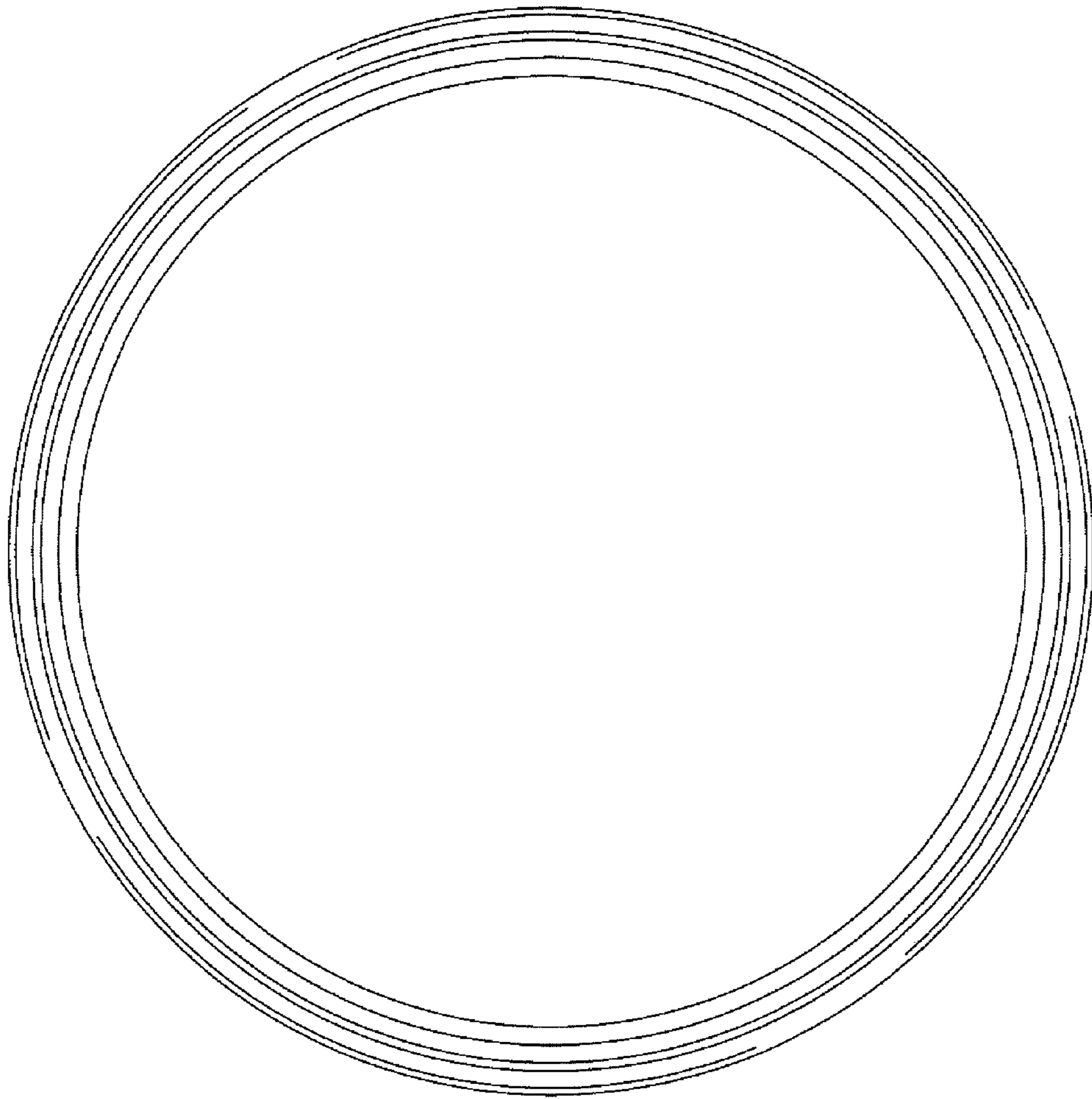

FIG. 15

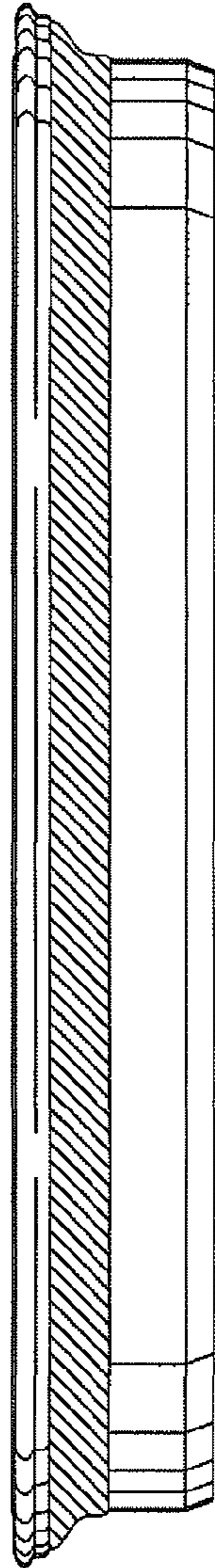

FIG. 16

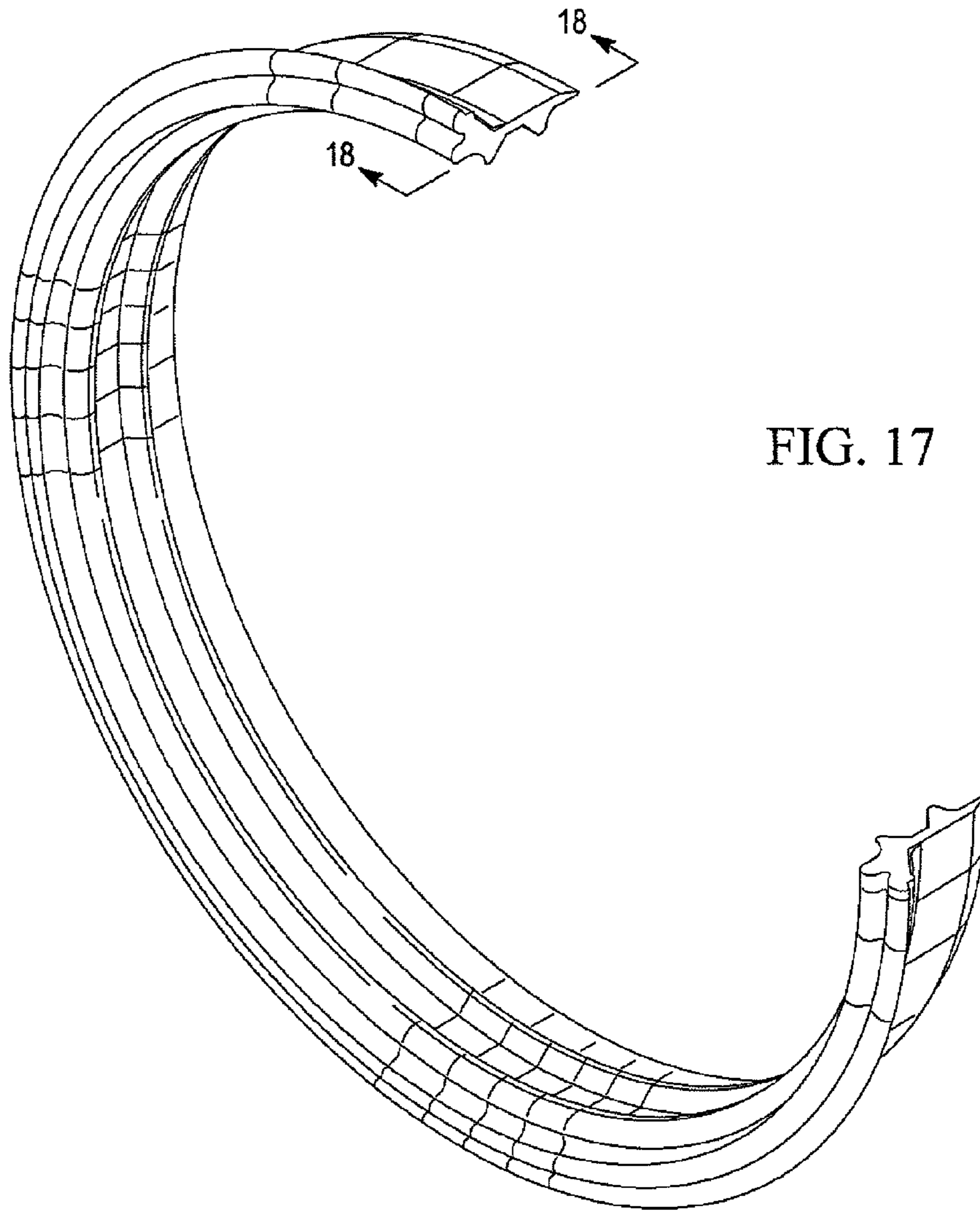

FIG. 17

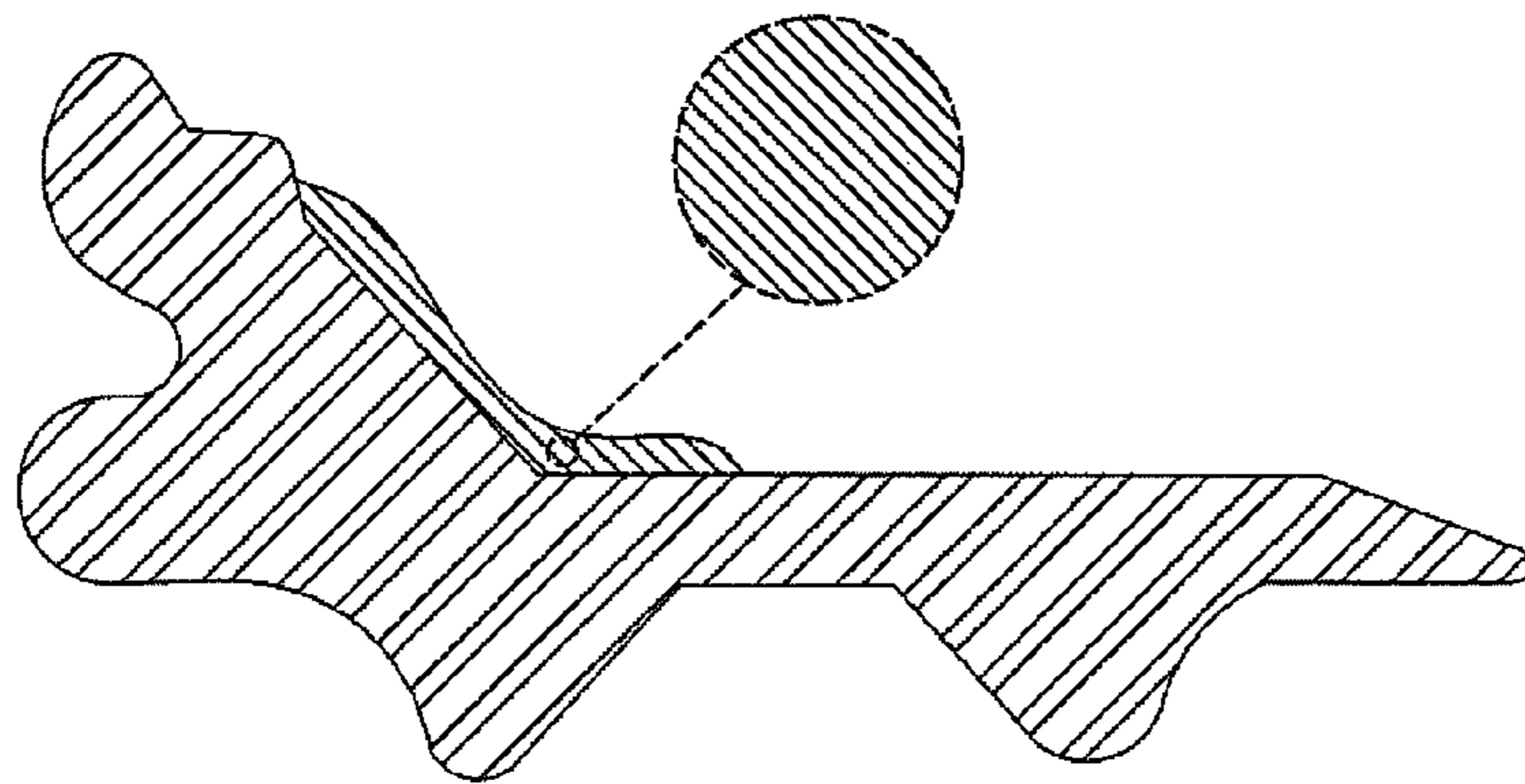

FIG. 18

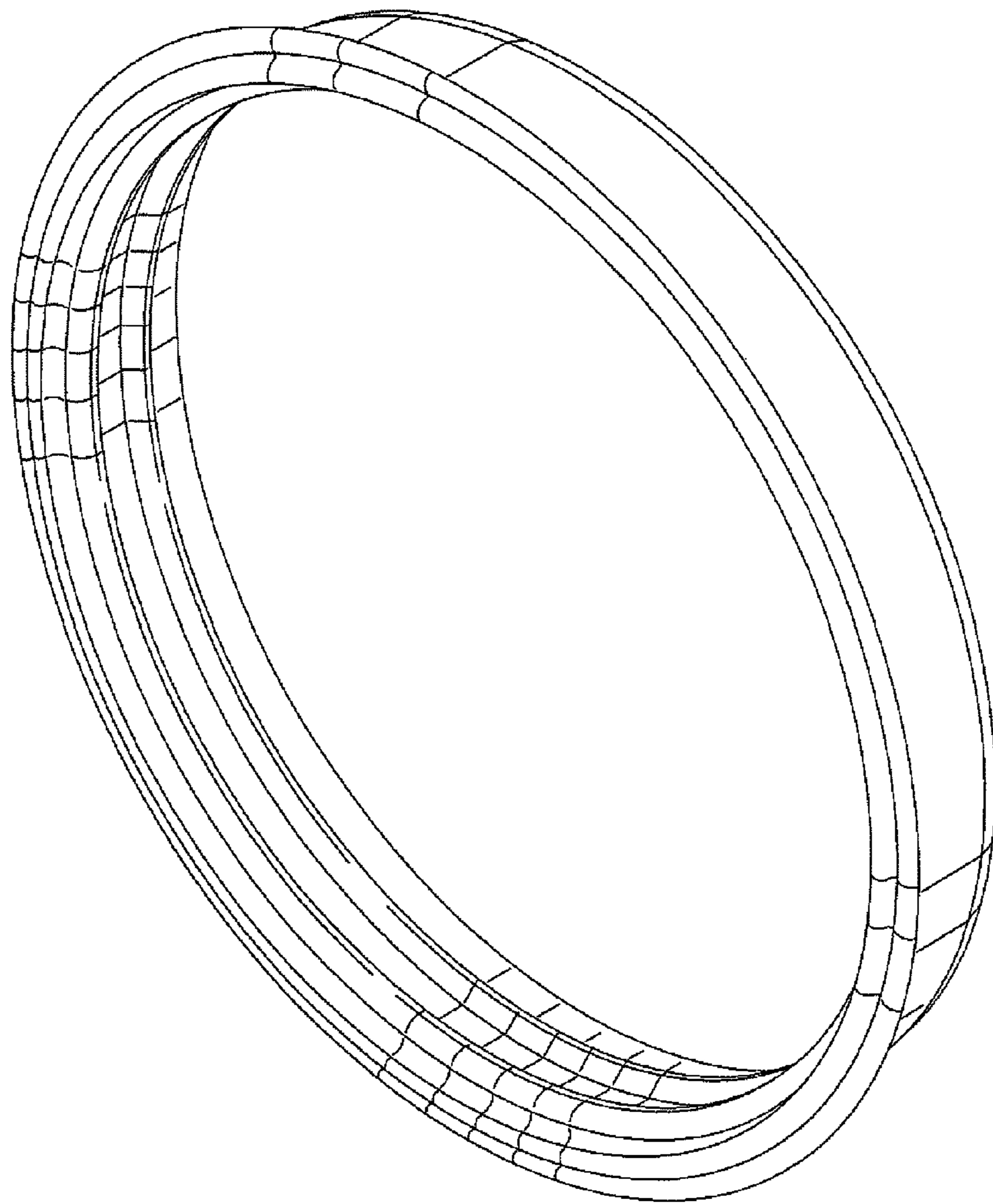

FIG. 19

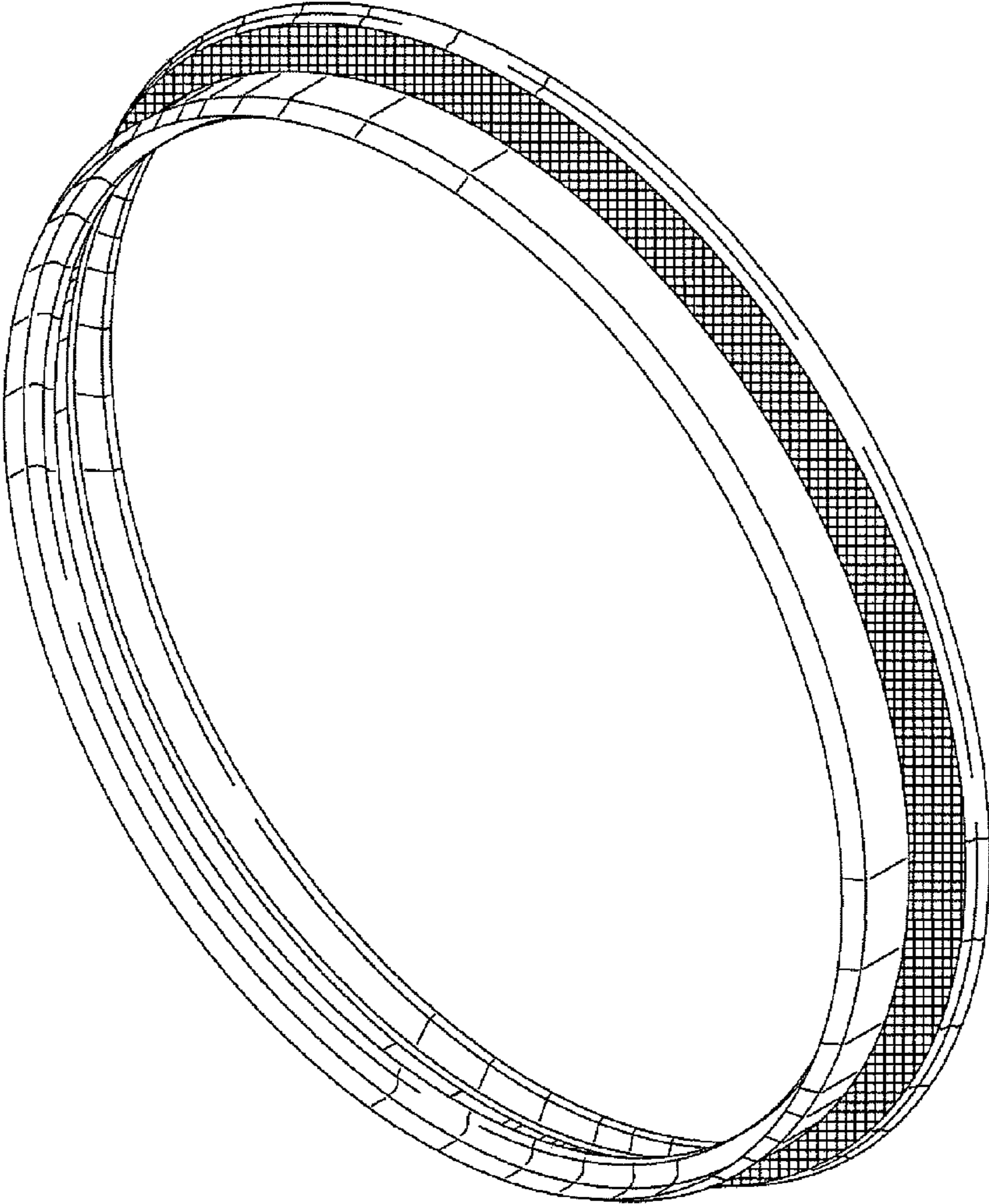

FIG. 20

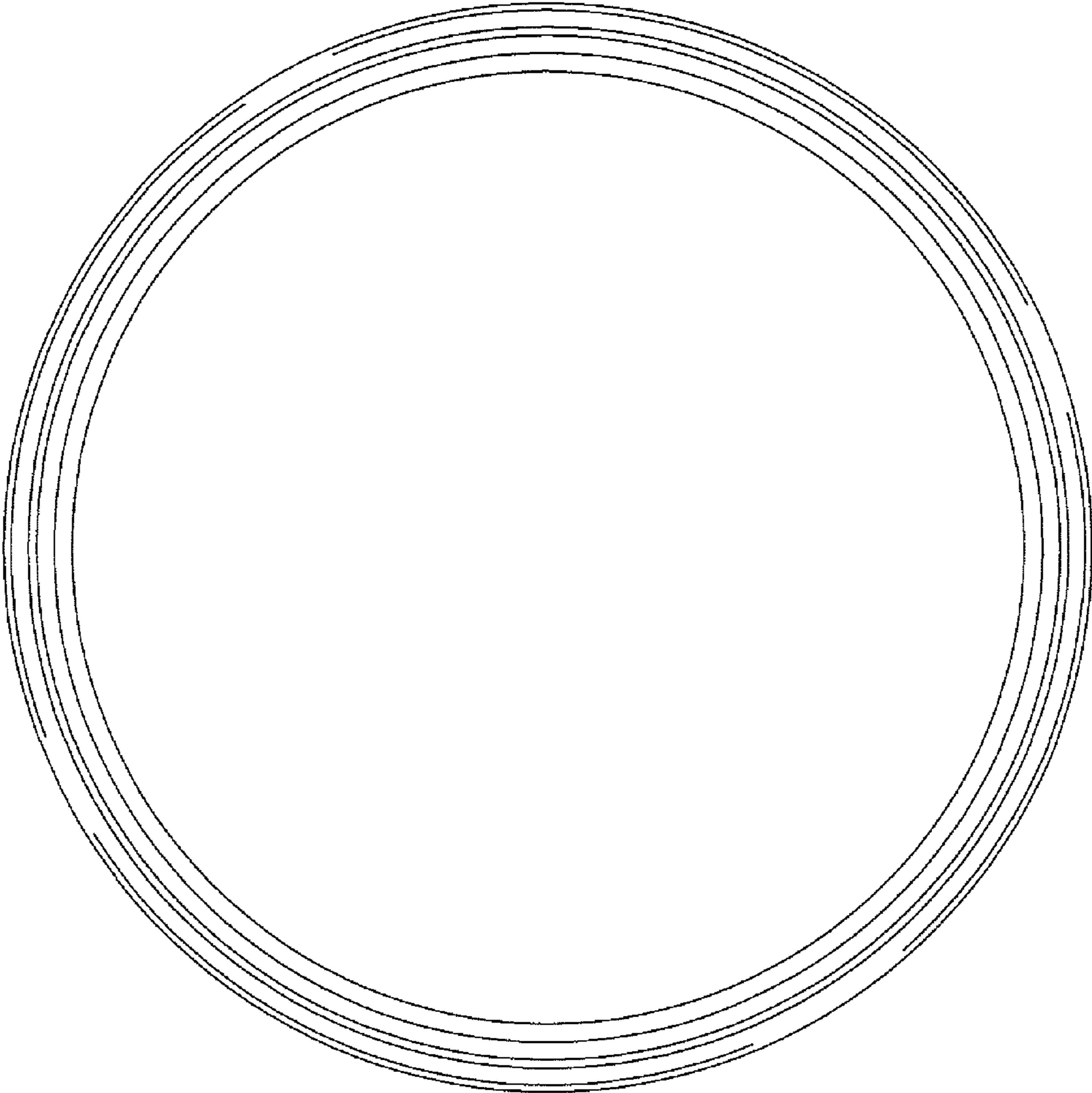

FIG. 21

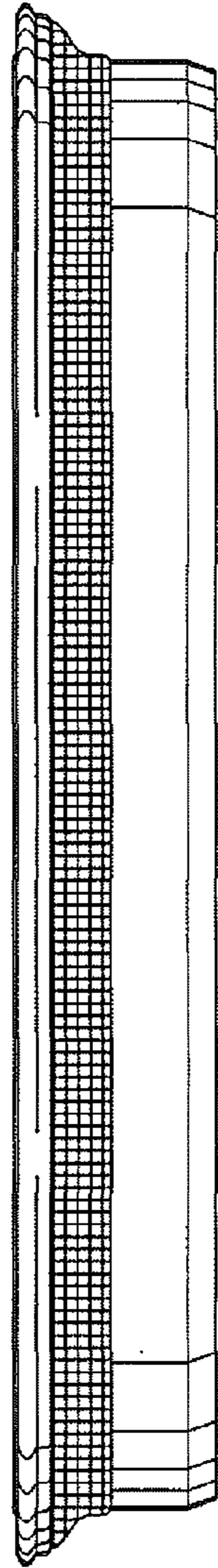

FIG. 22

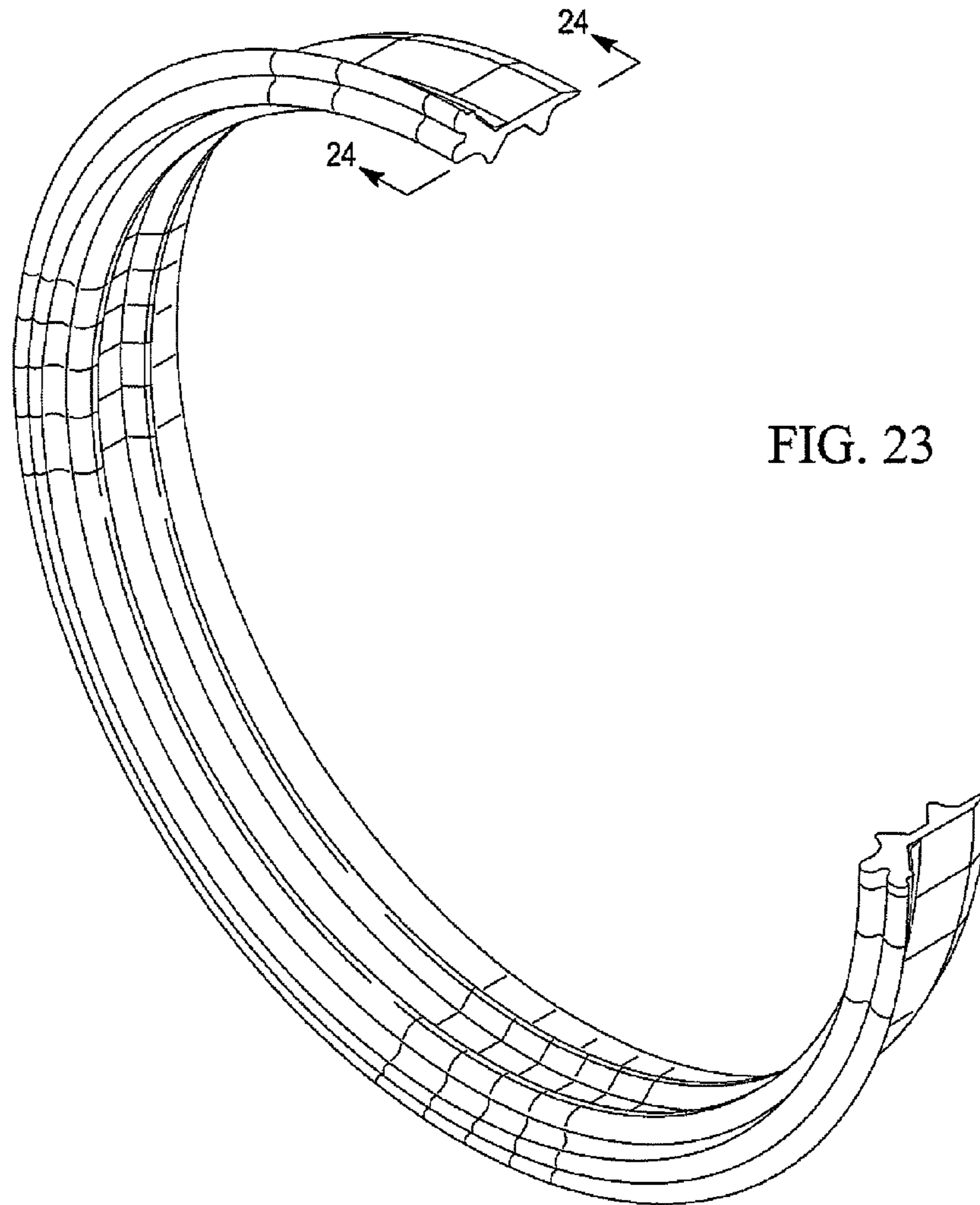

FIG. 23

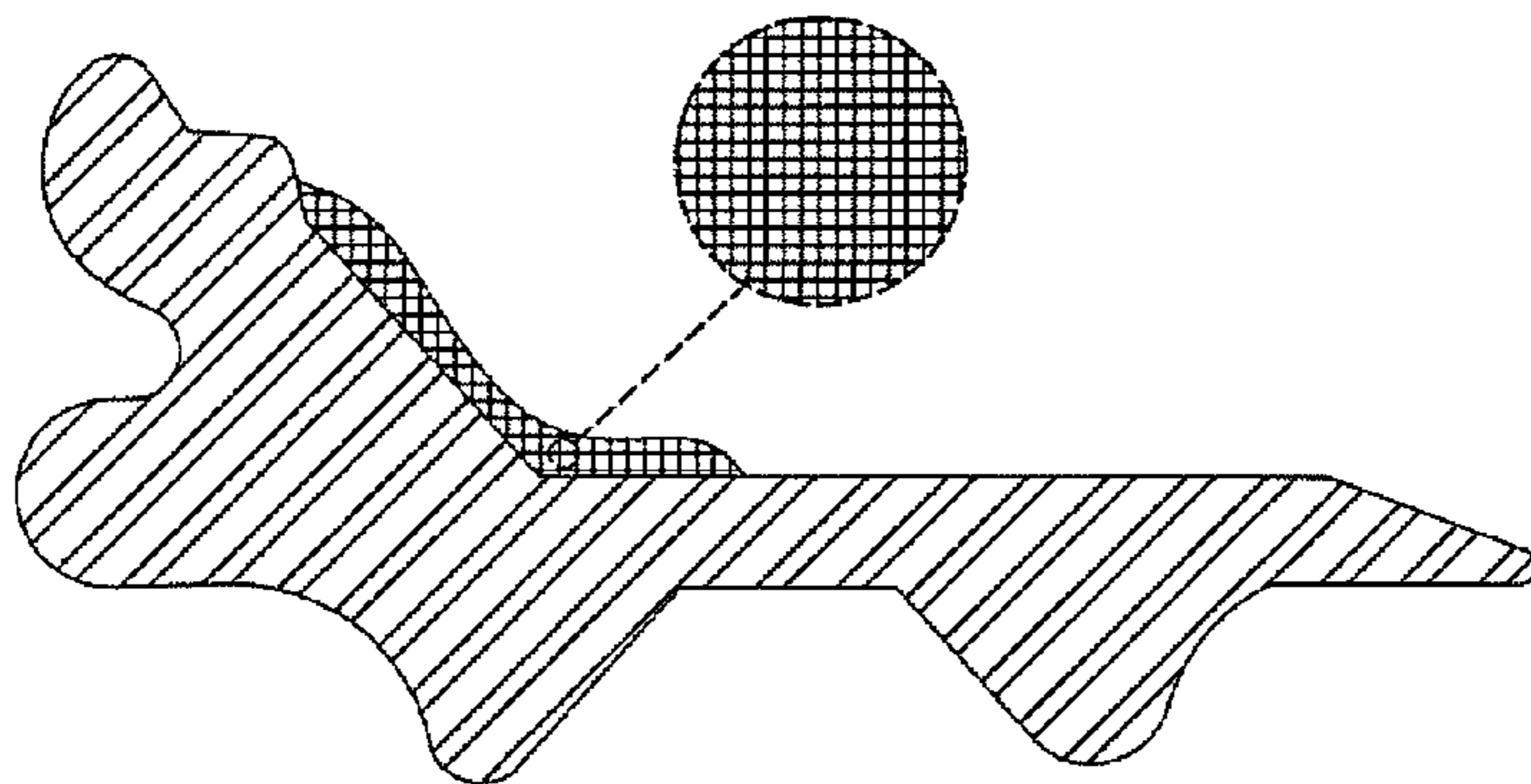

FIG. 24

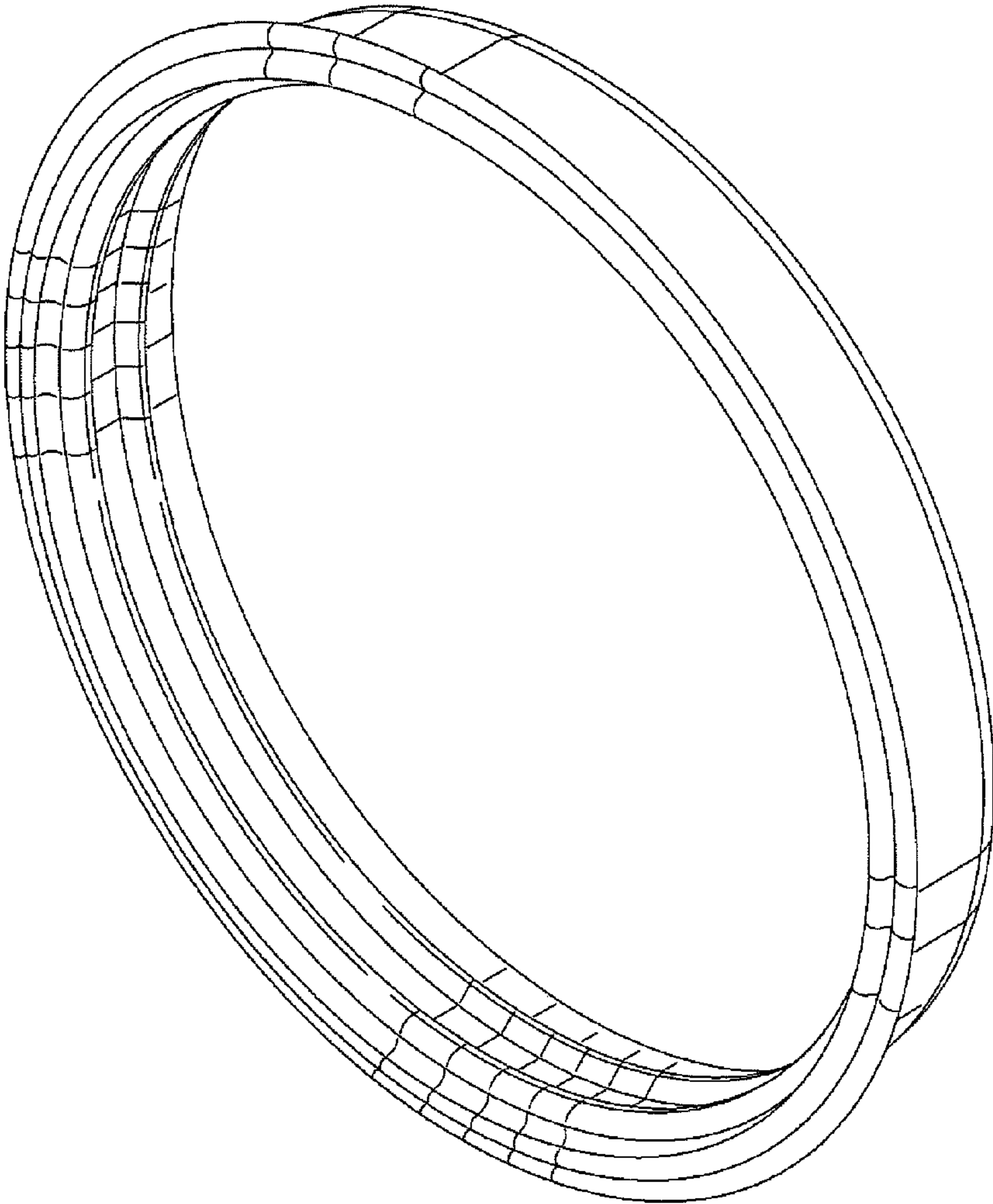

FIG. 25

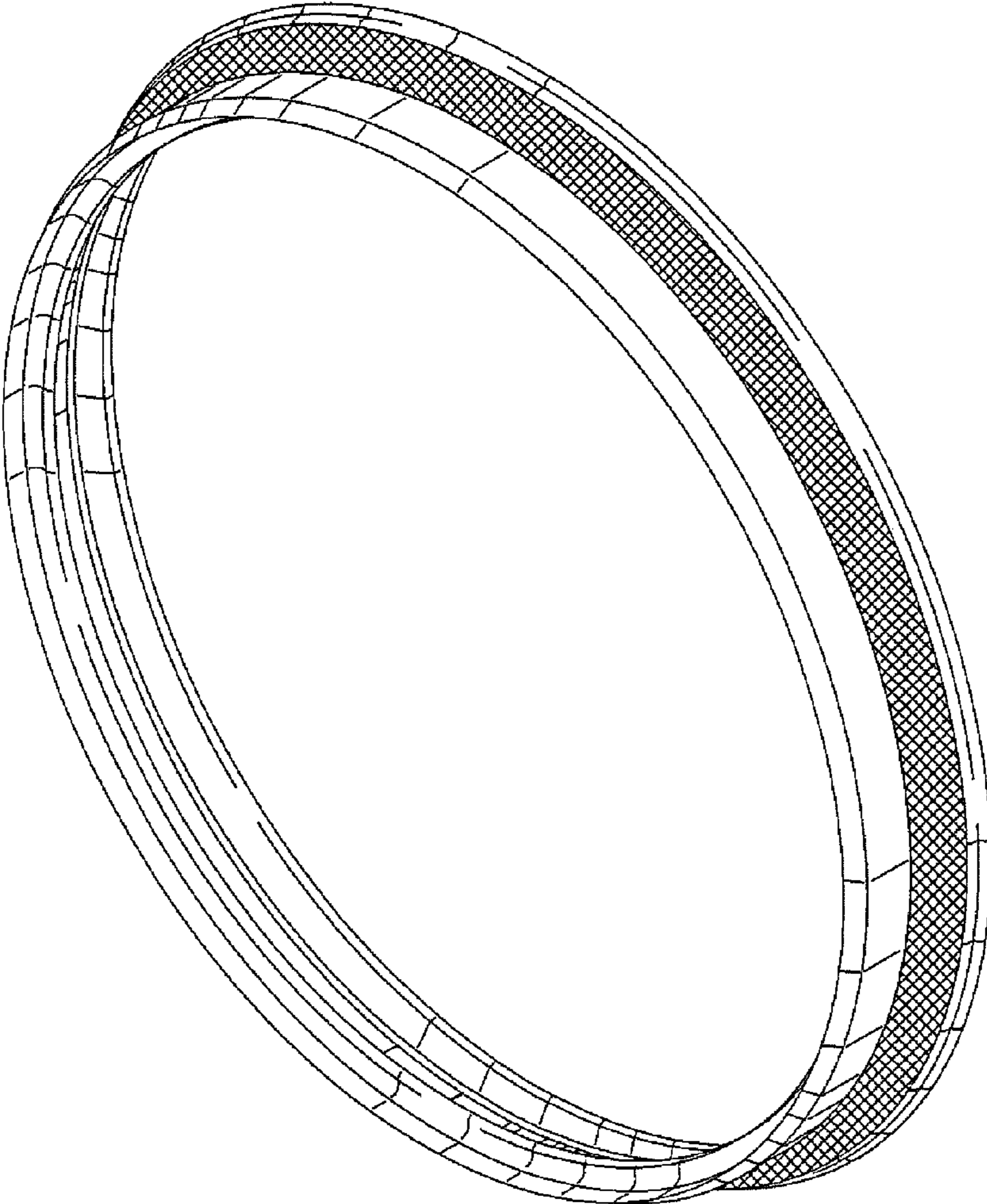

FIG. 26

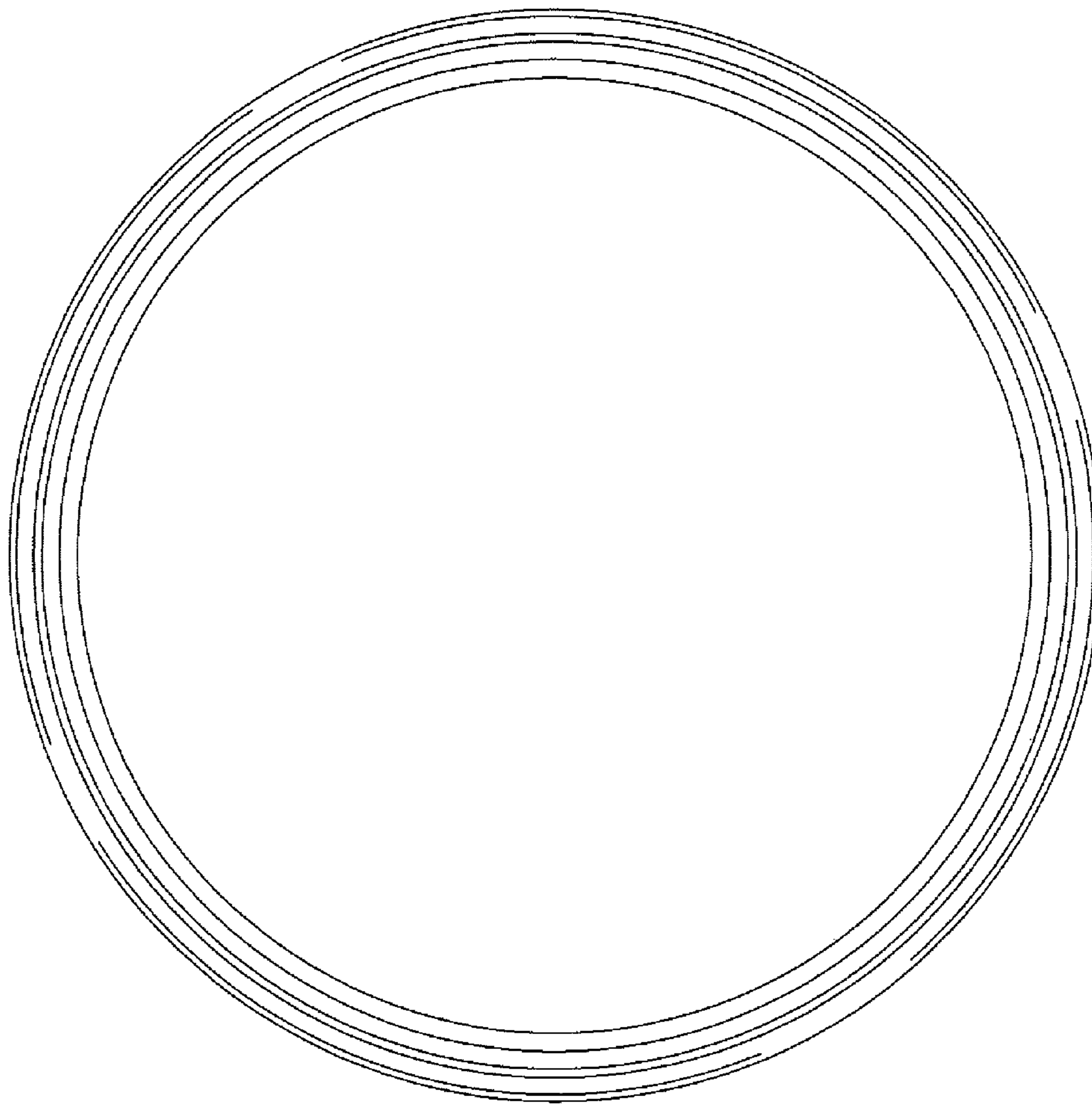

FIG. 27

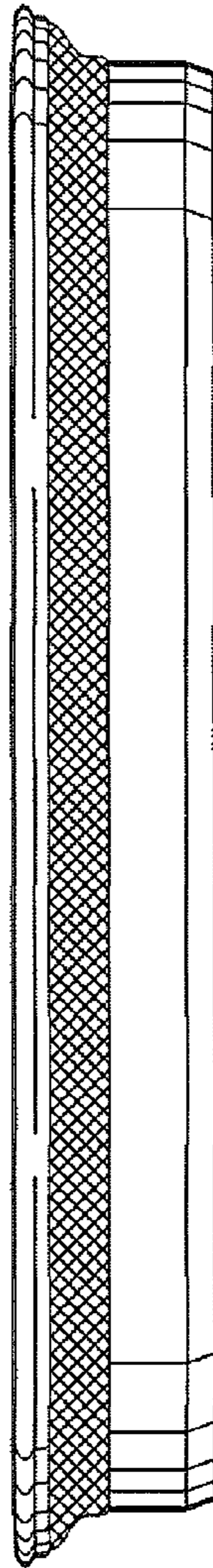

FIG. 28

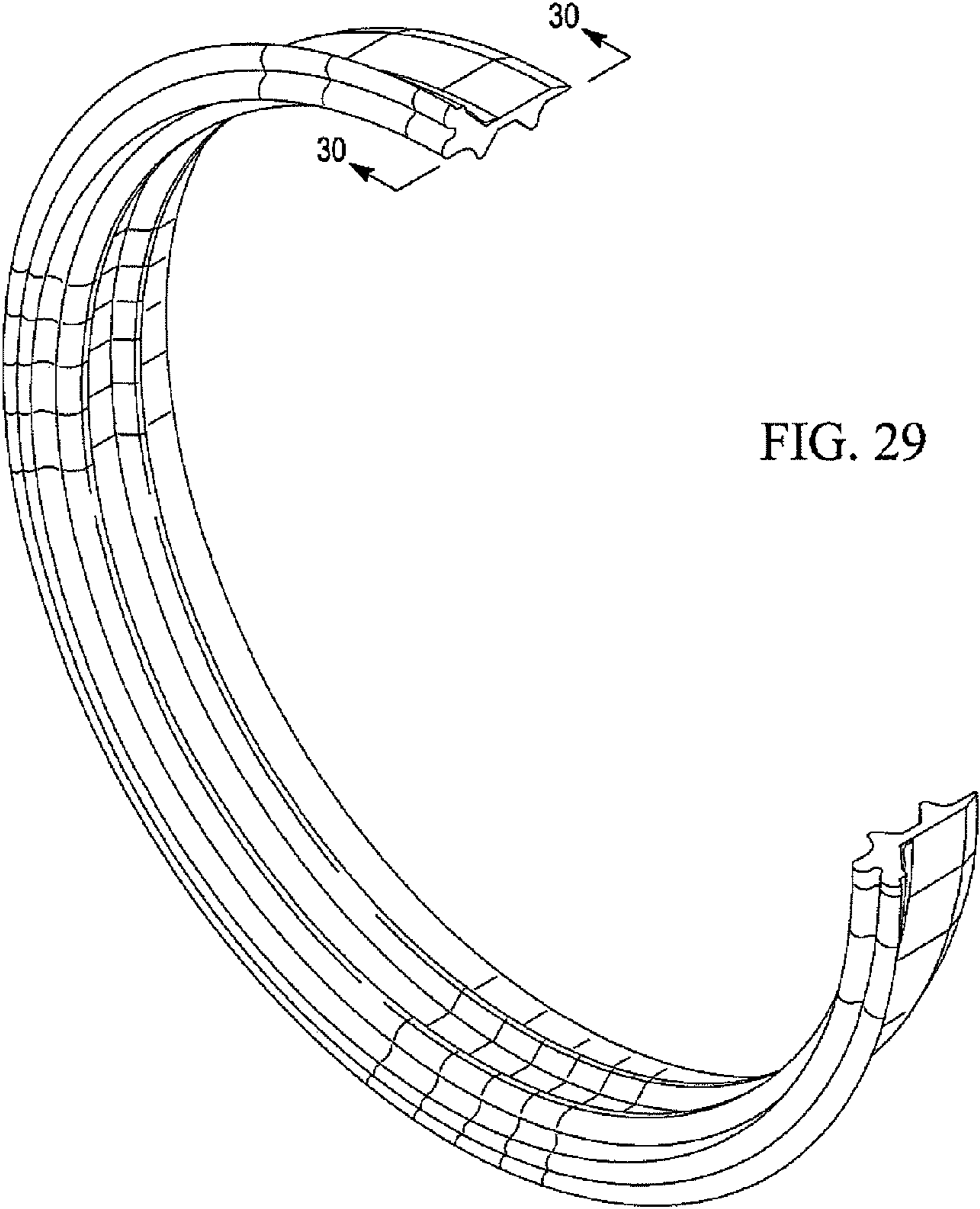

FIG. 29

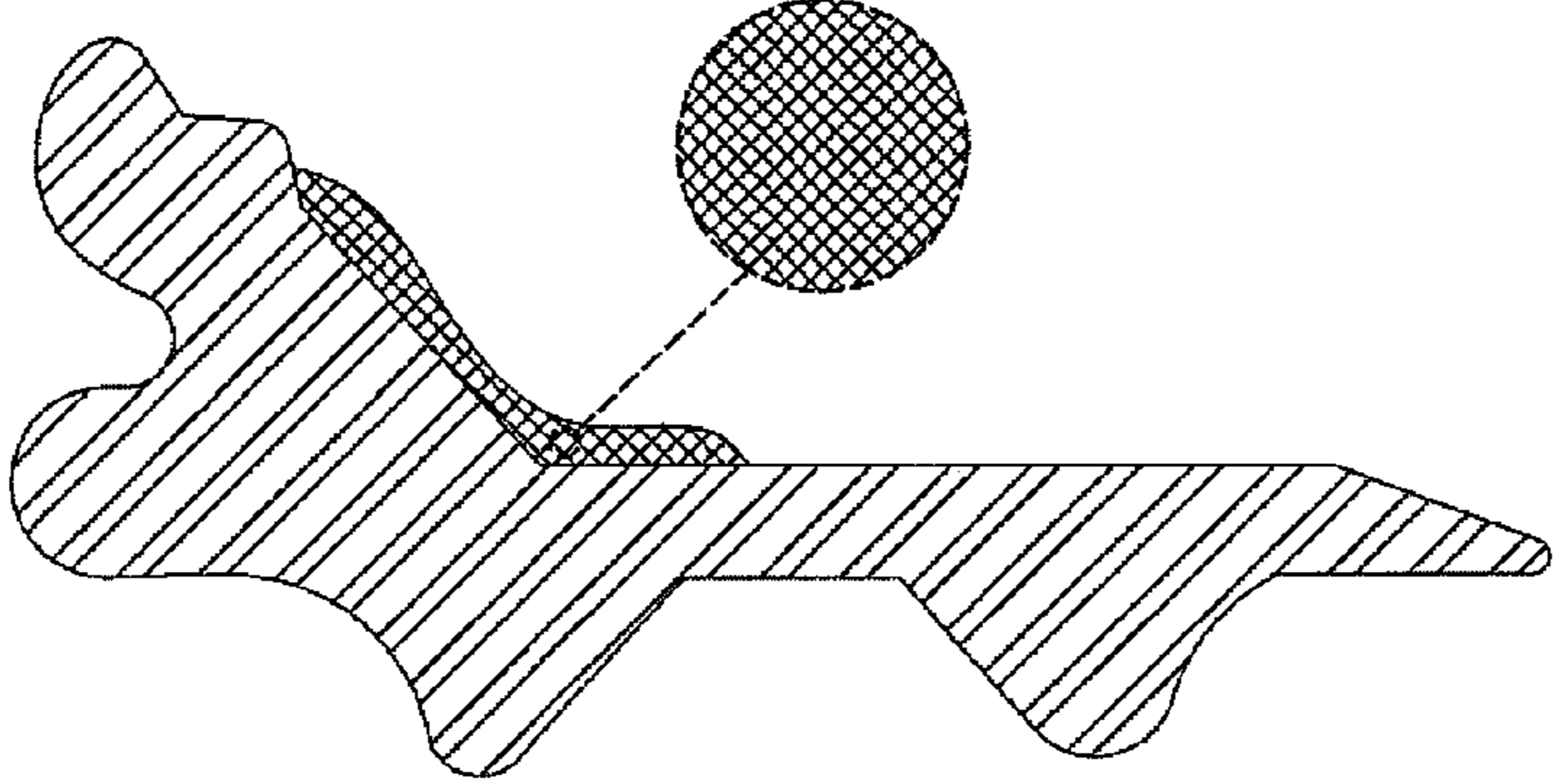

FIG. 30

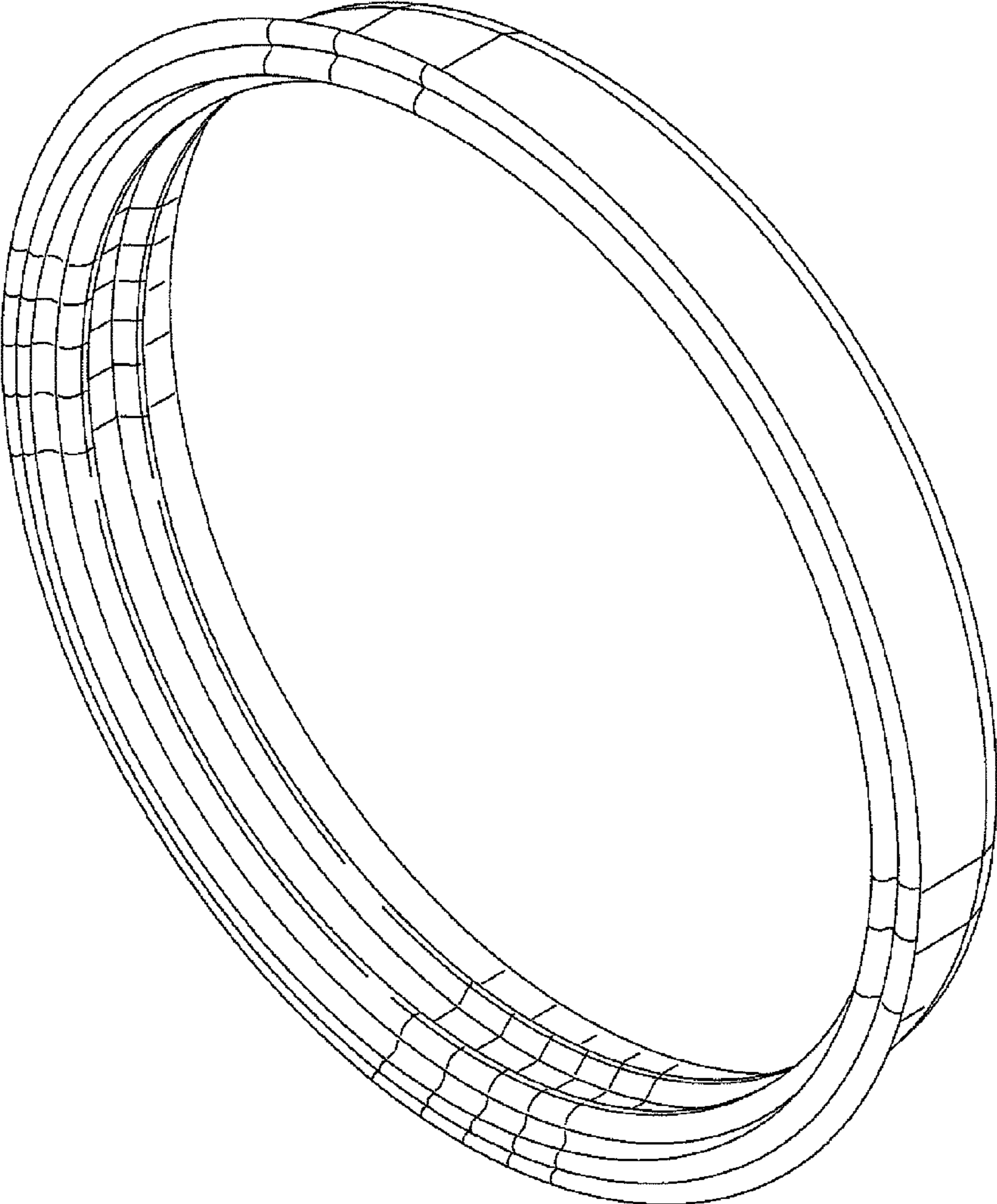

FIG. 31

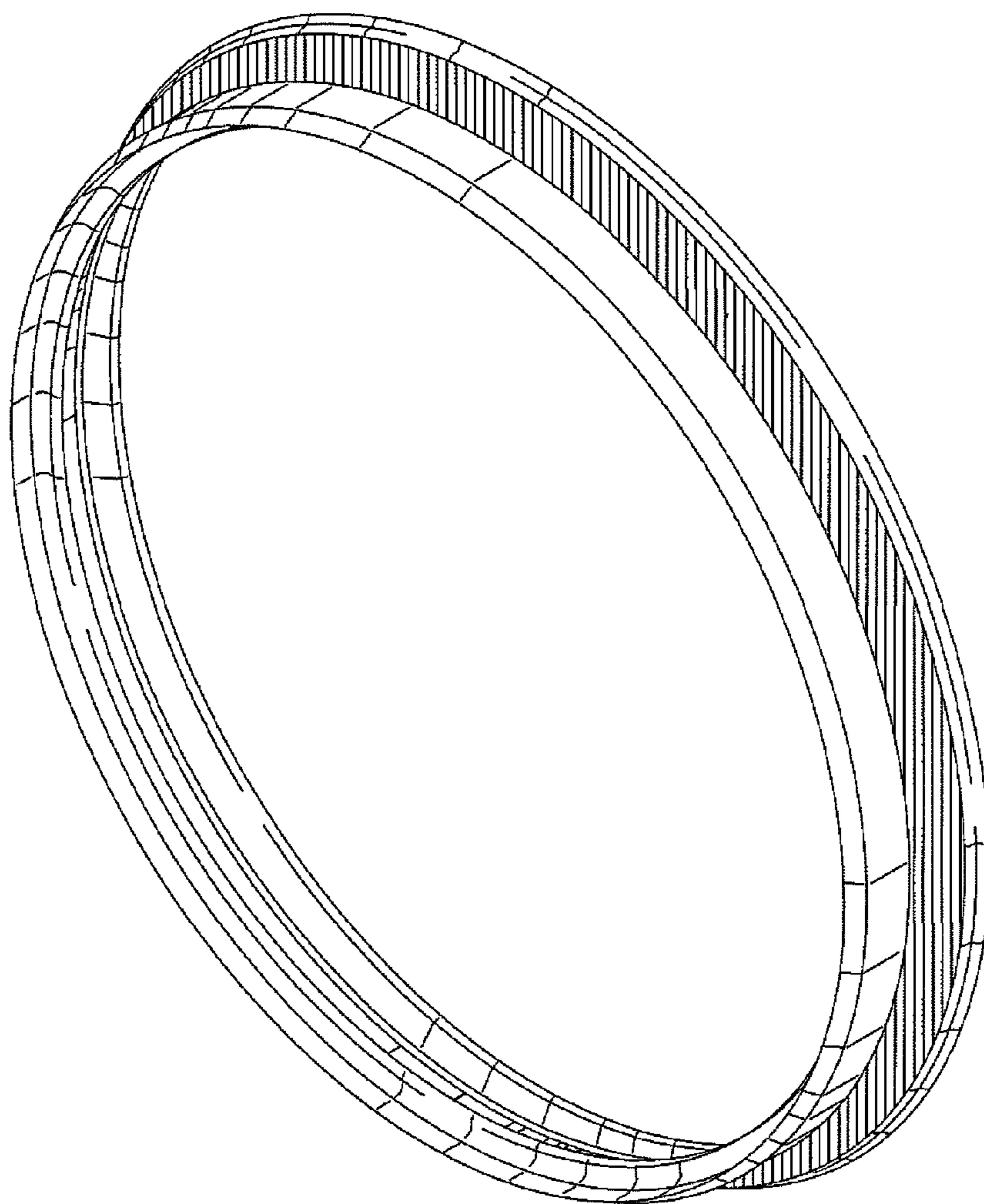

FIG. 32

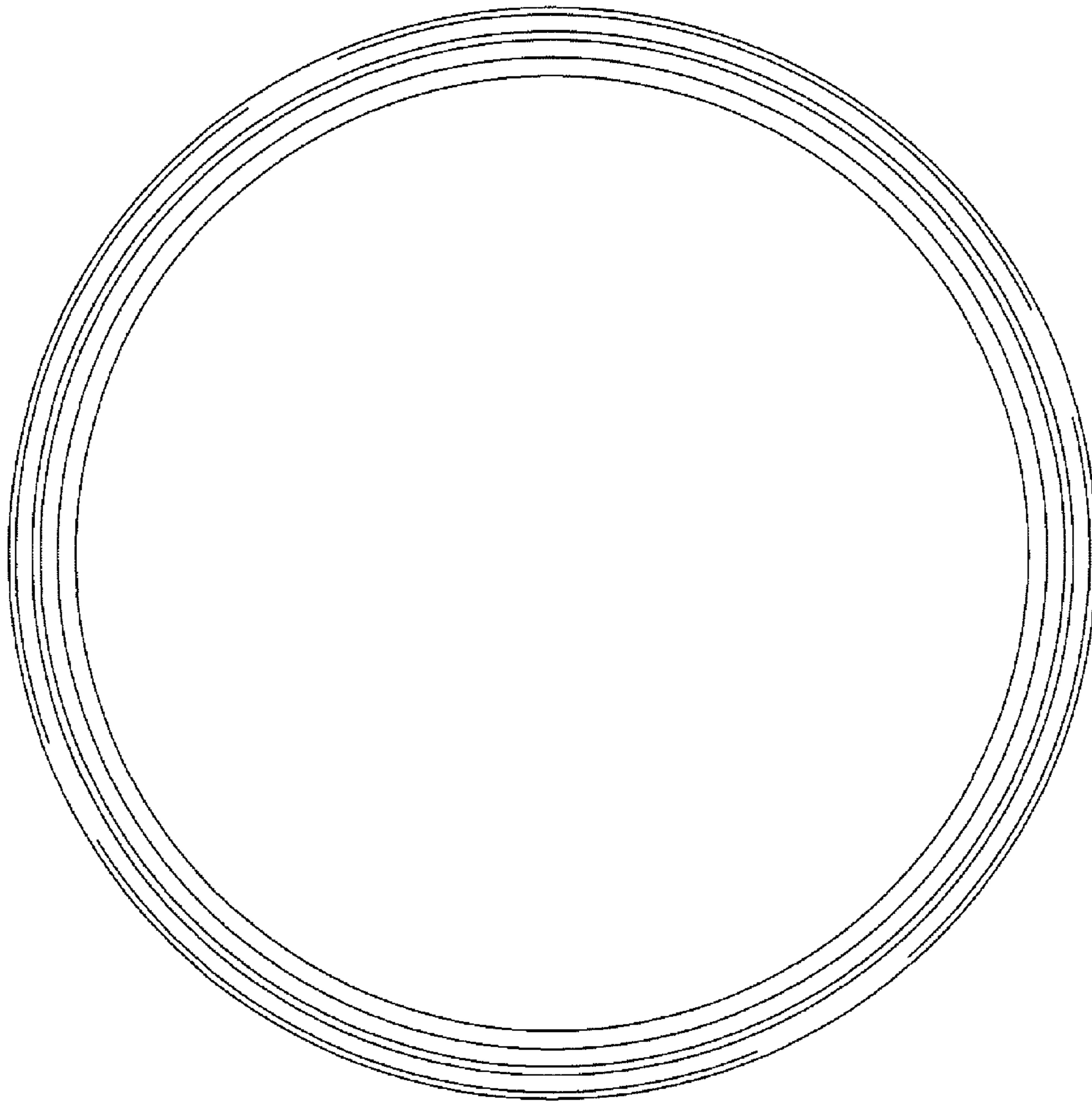

FIG. 33

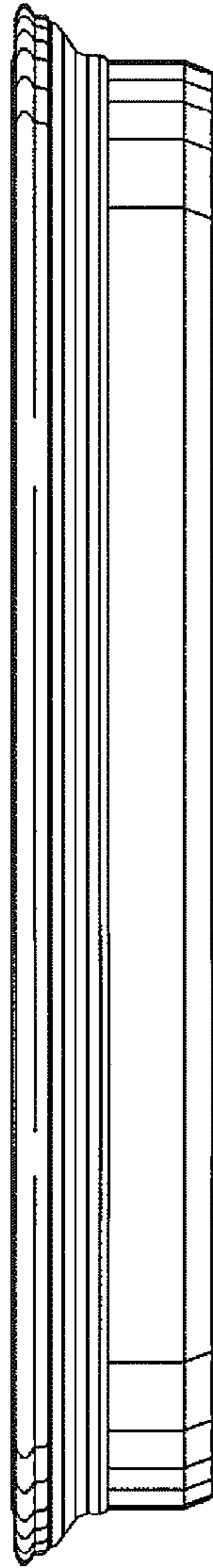

FIG. 34

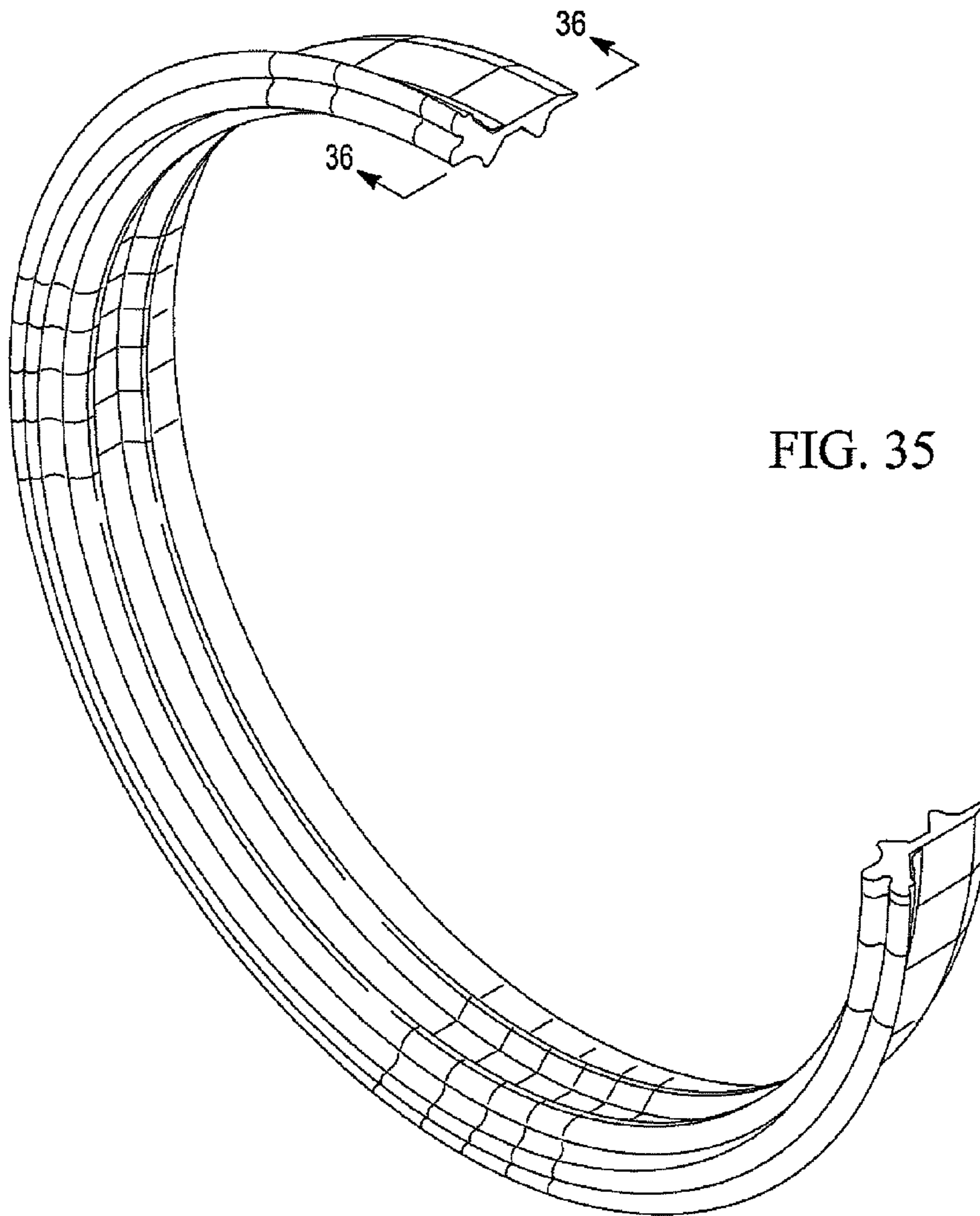

FIG. 35

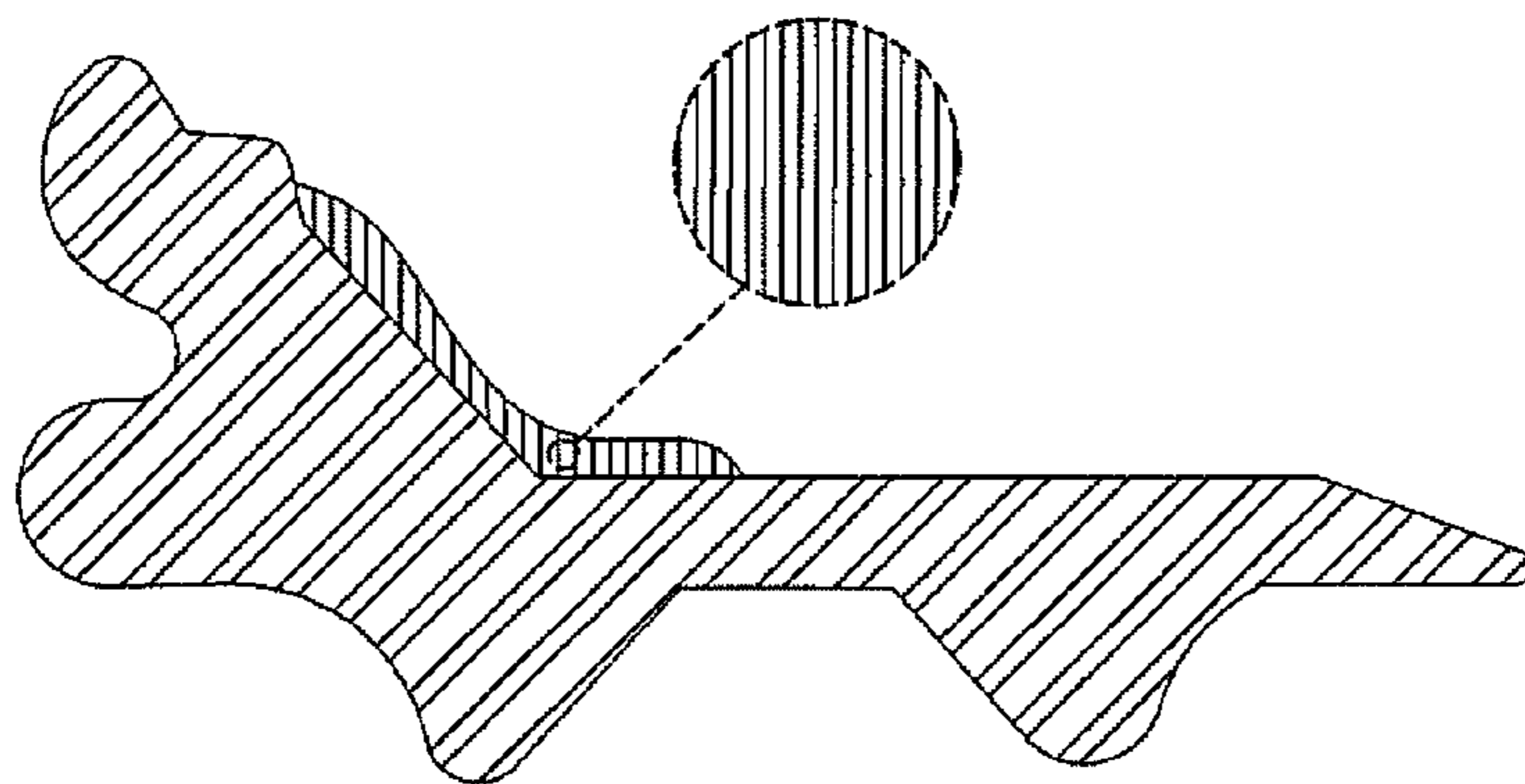

FIG. 36

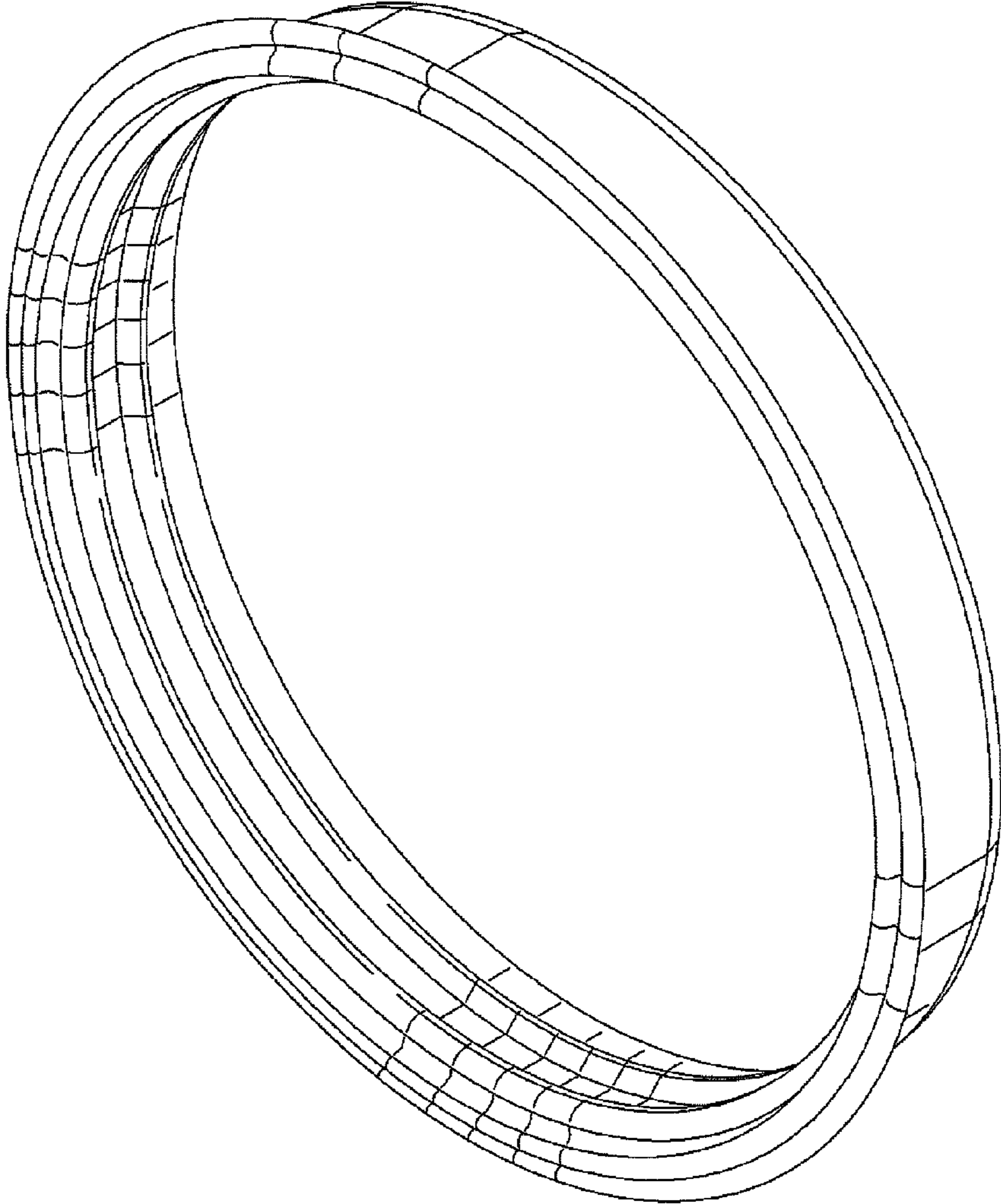

FIG. 37

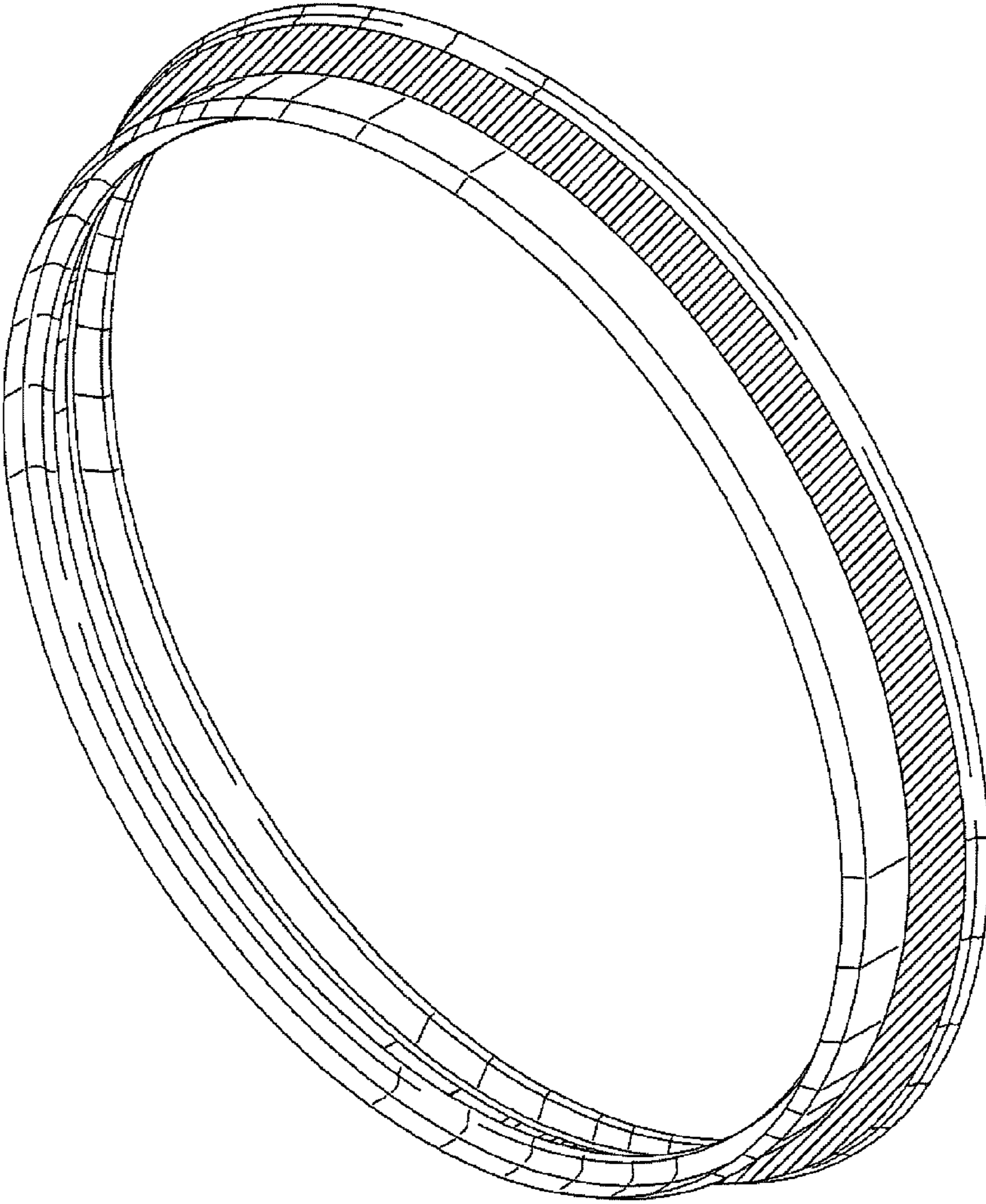

FIG. 38

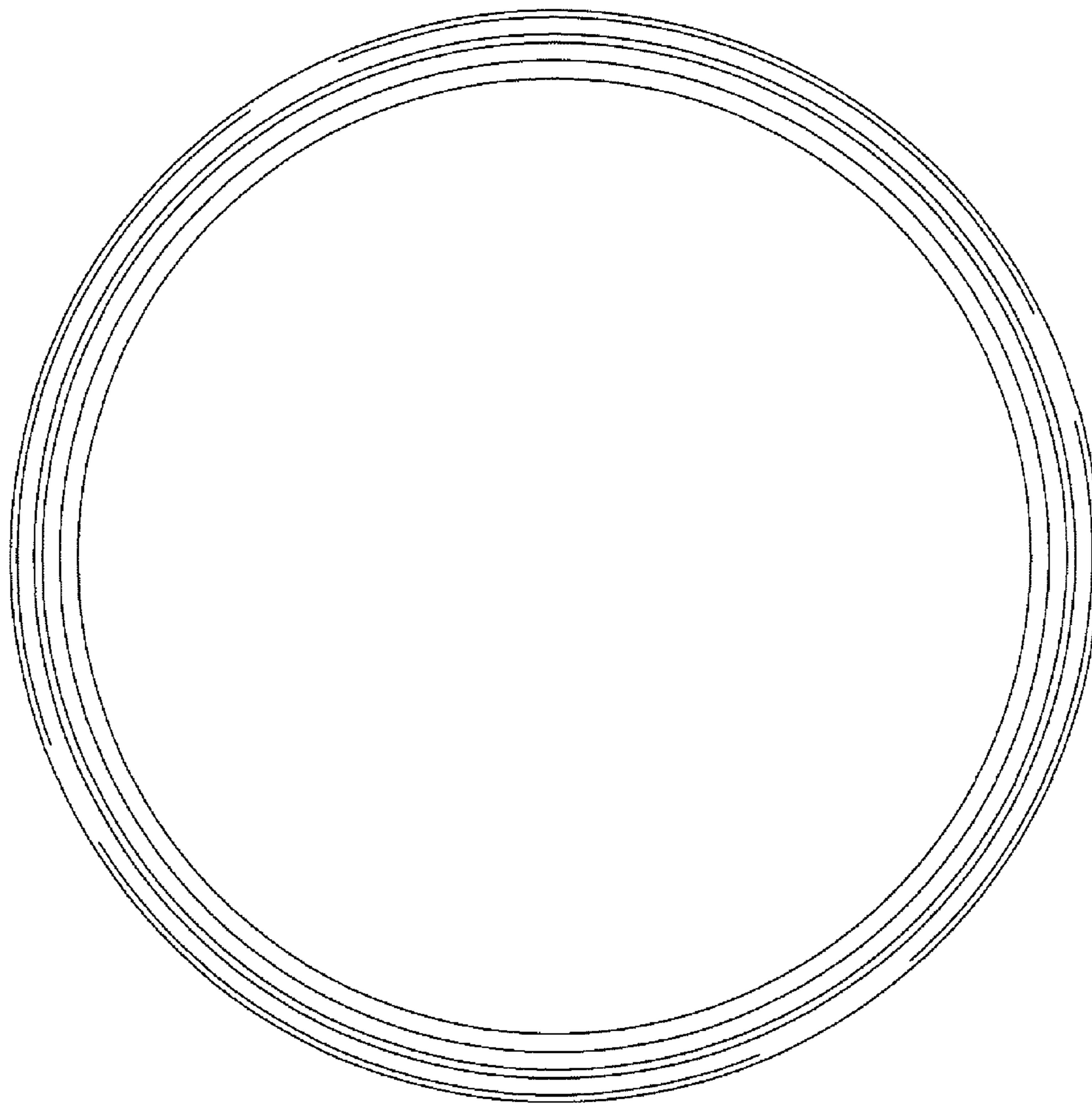

FIG. 39

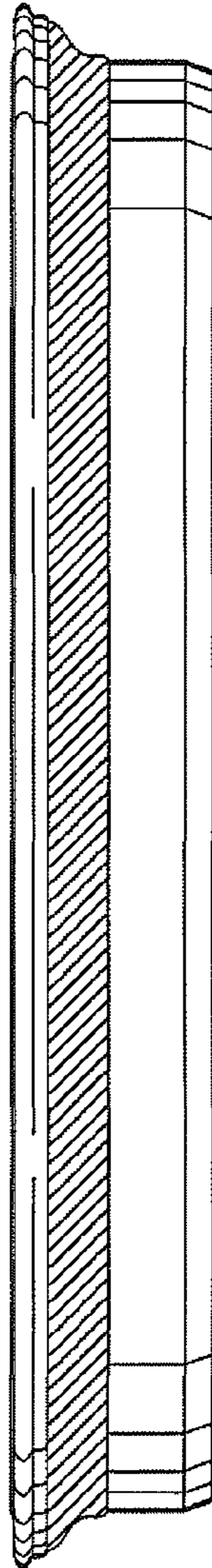

FIG. 40

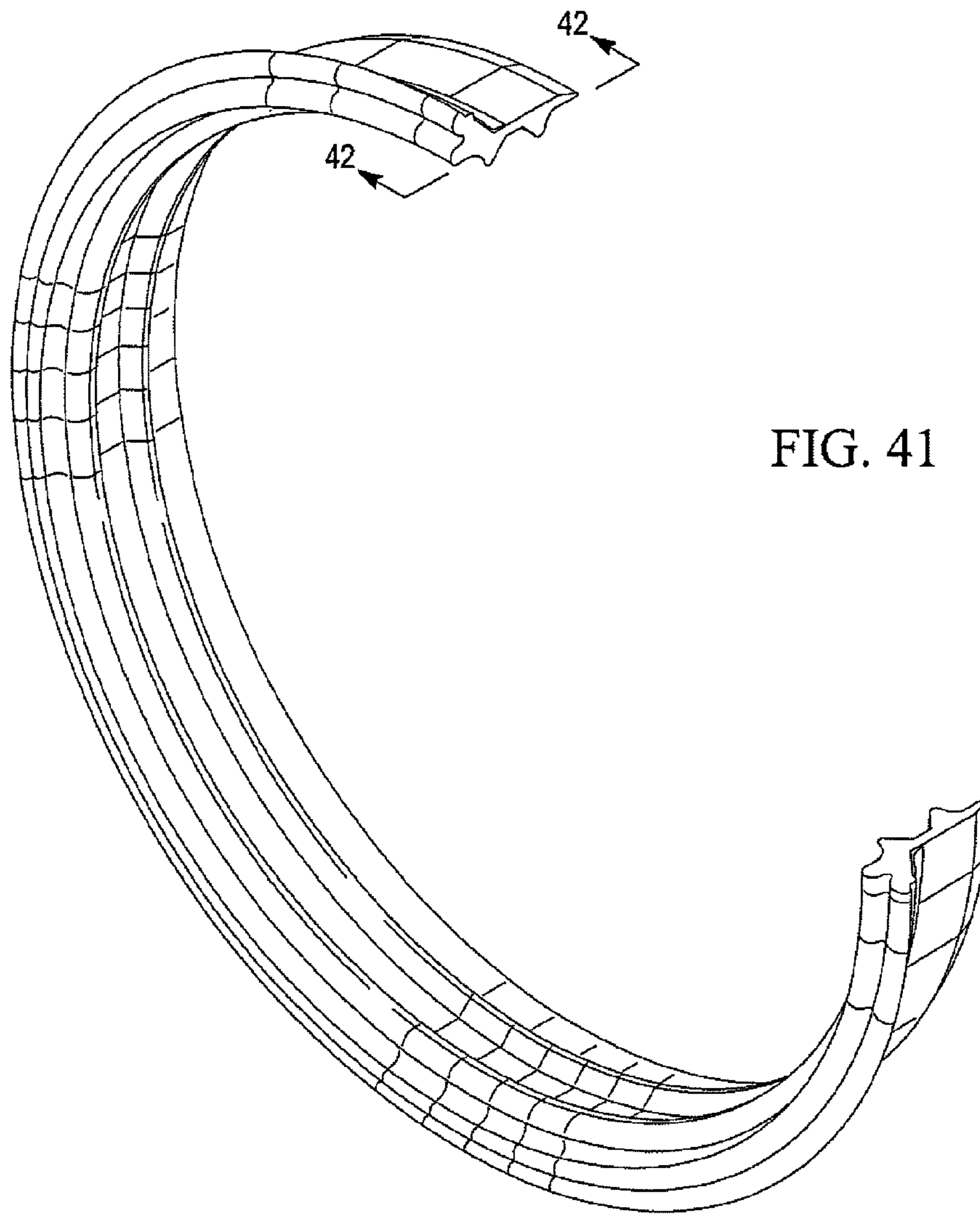

FIG. 41

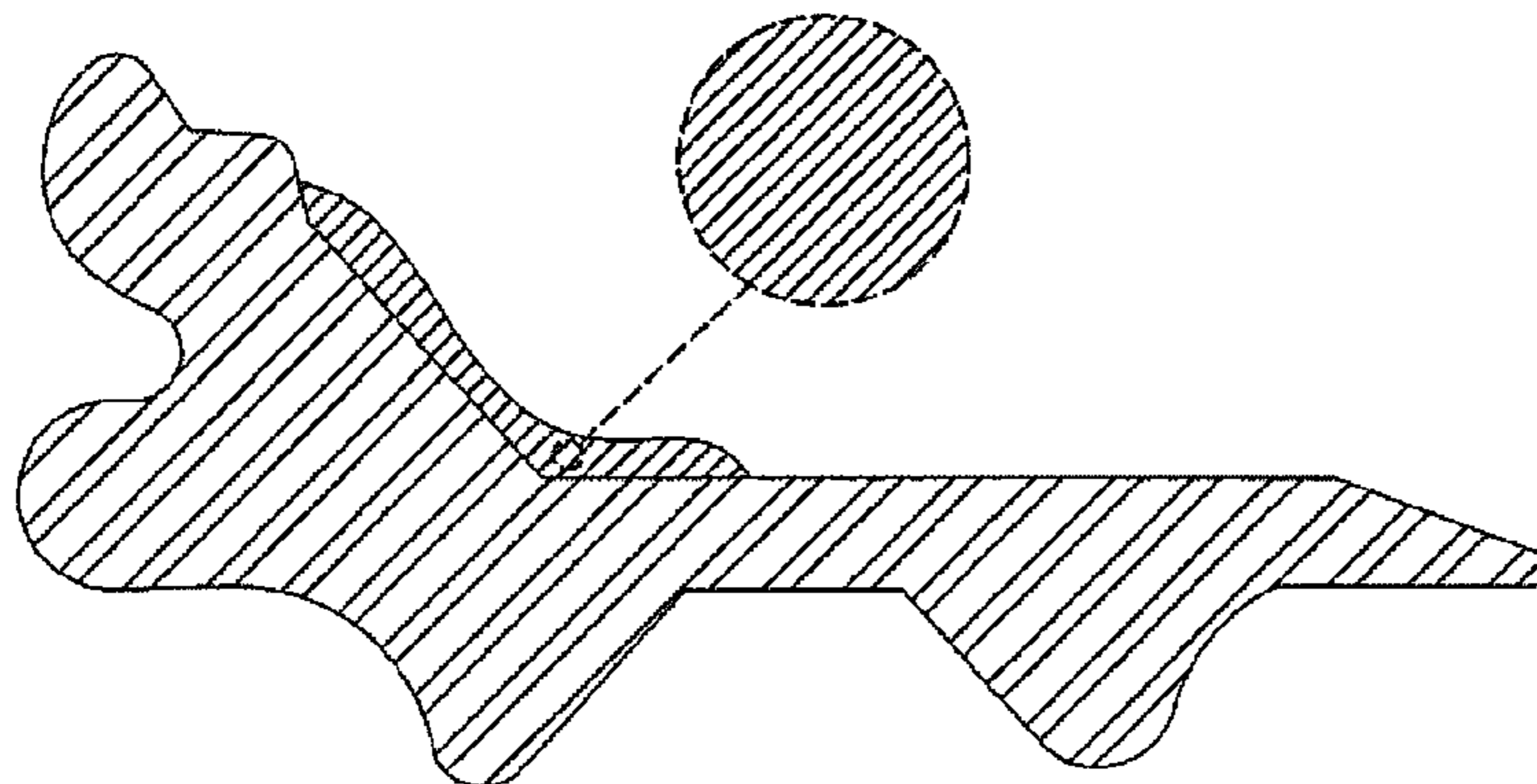

FIG. 42

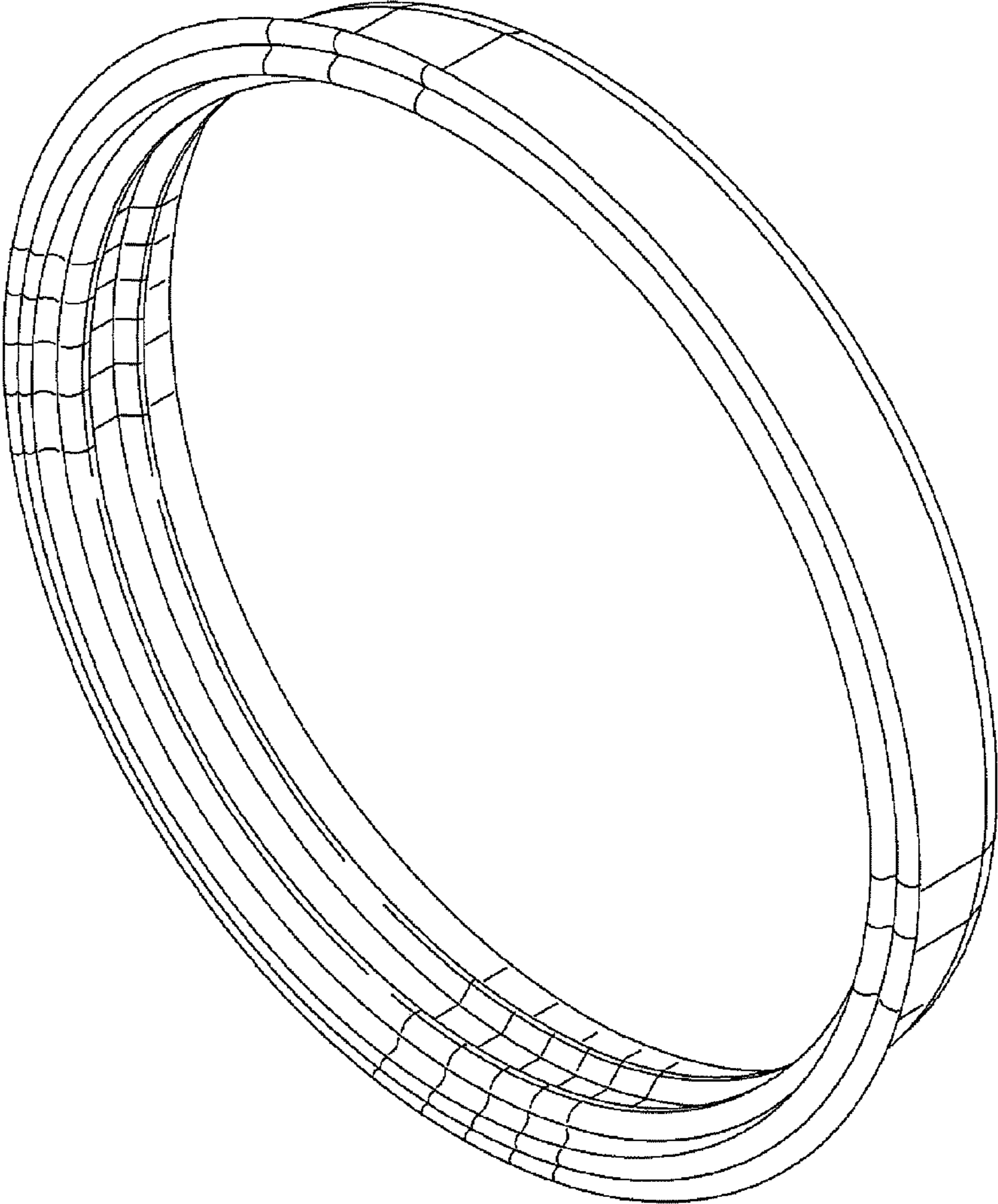

FIG. 43

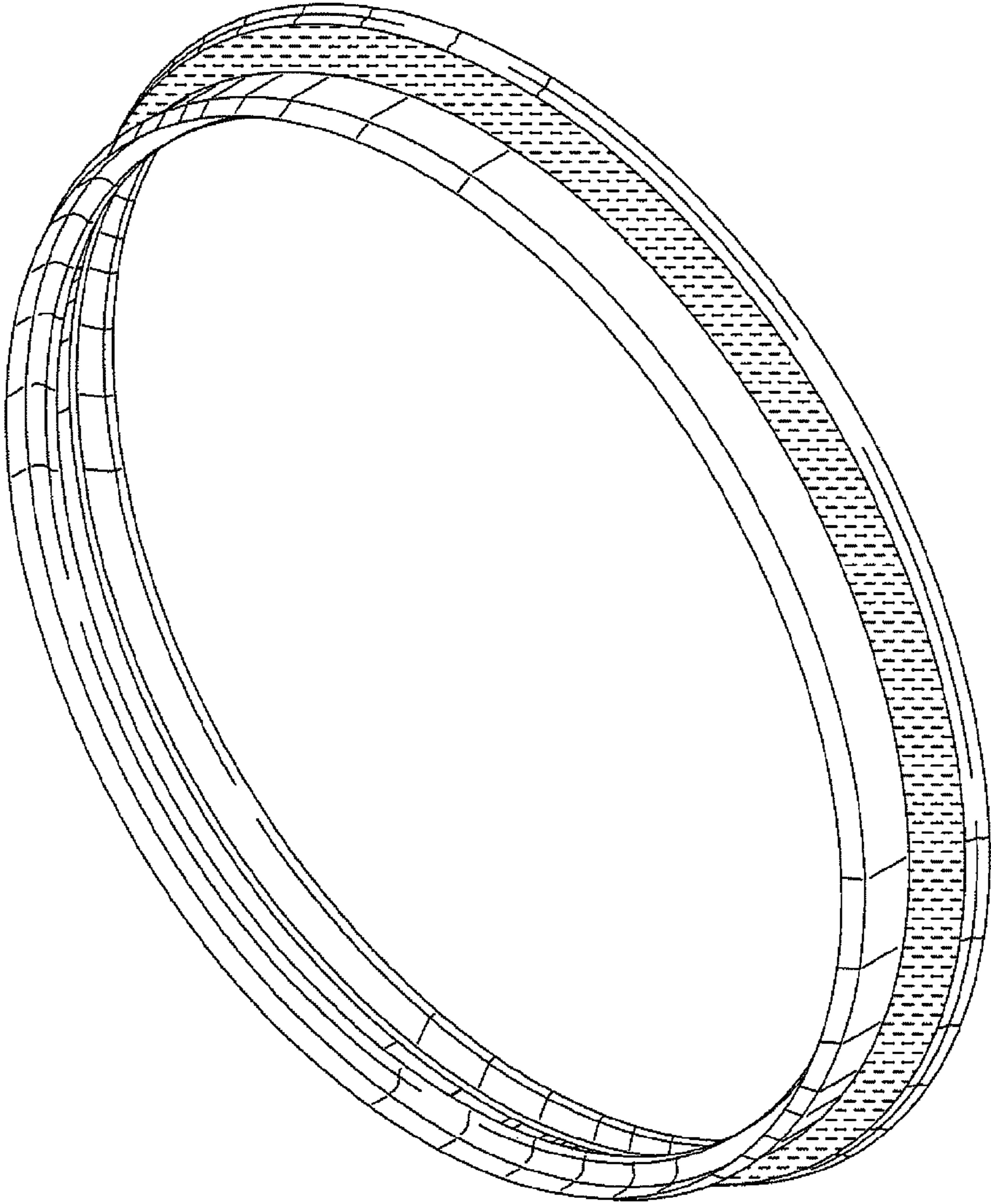

FIG. 44

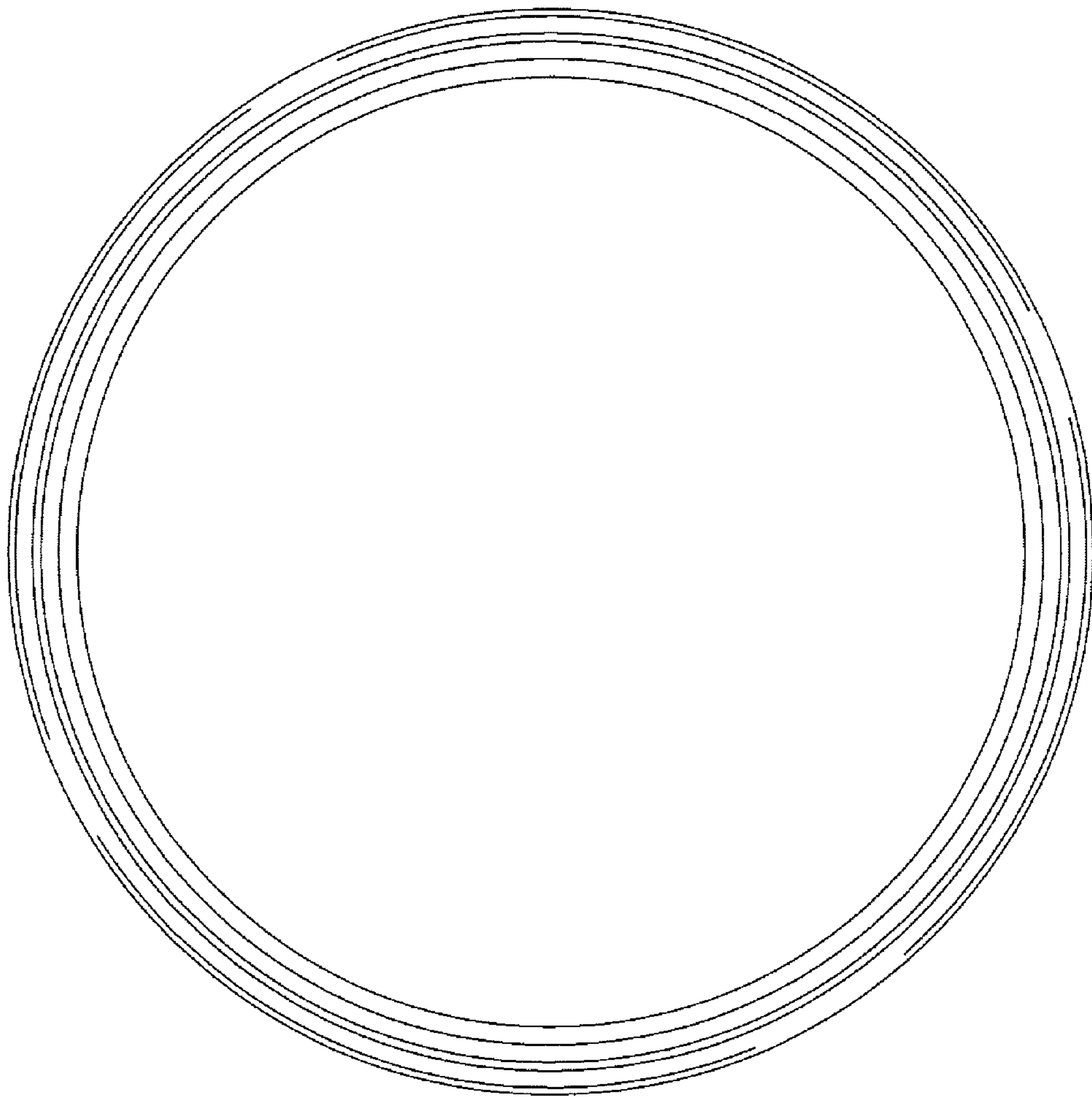

FIG. 45

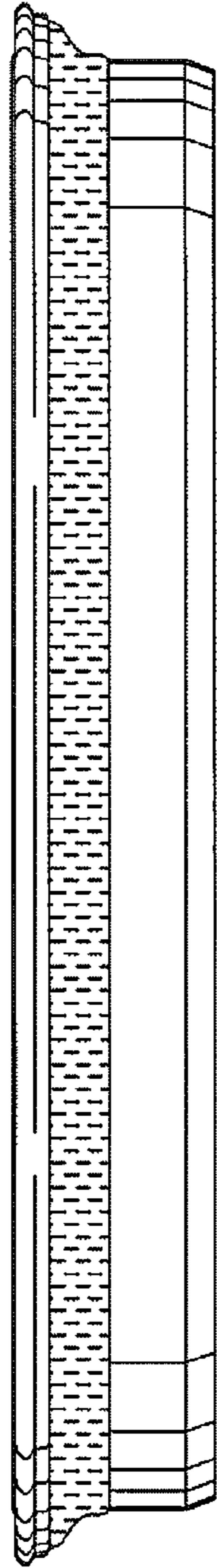

FIG. 46

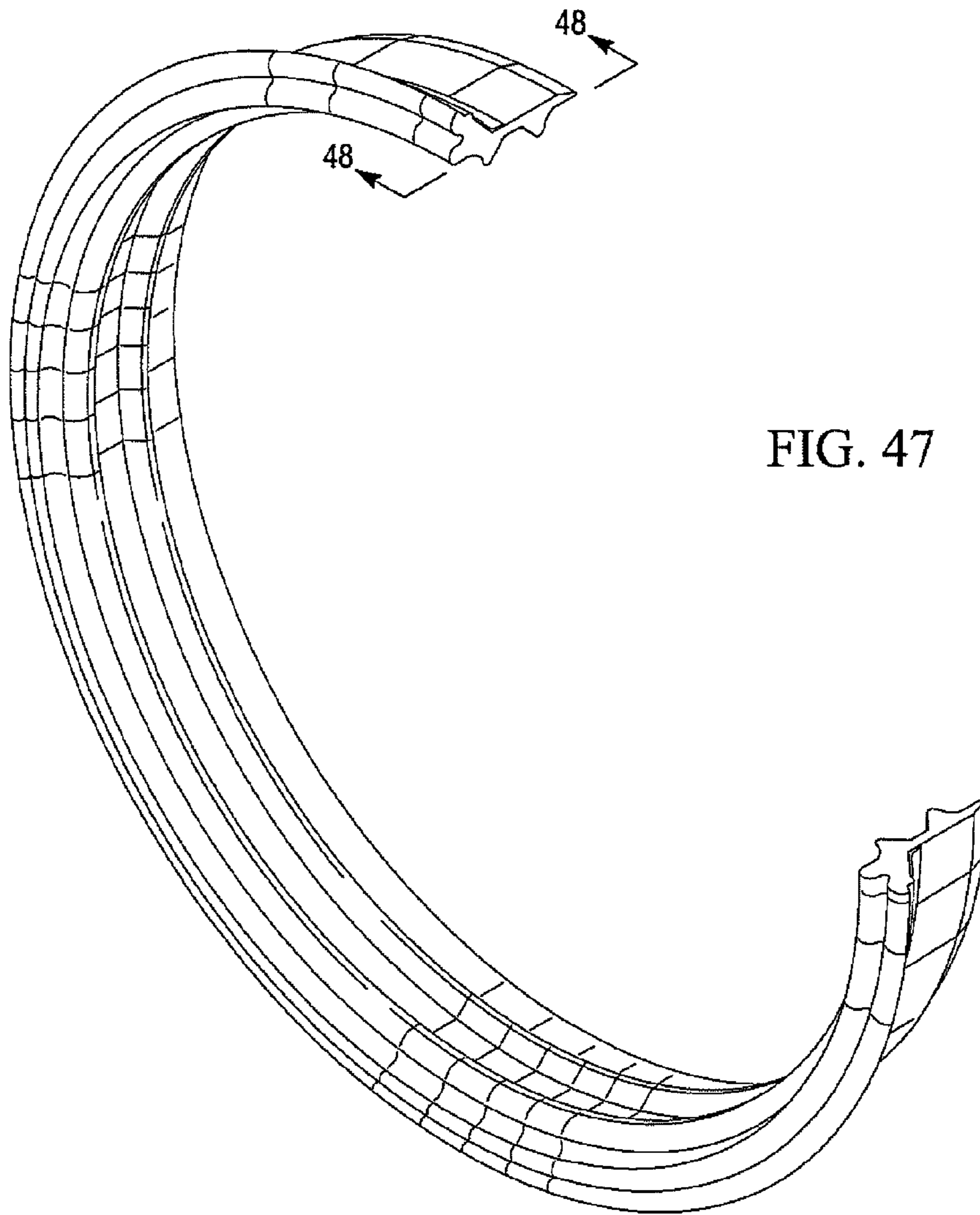

FIG. 47

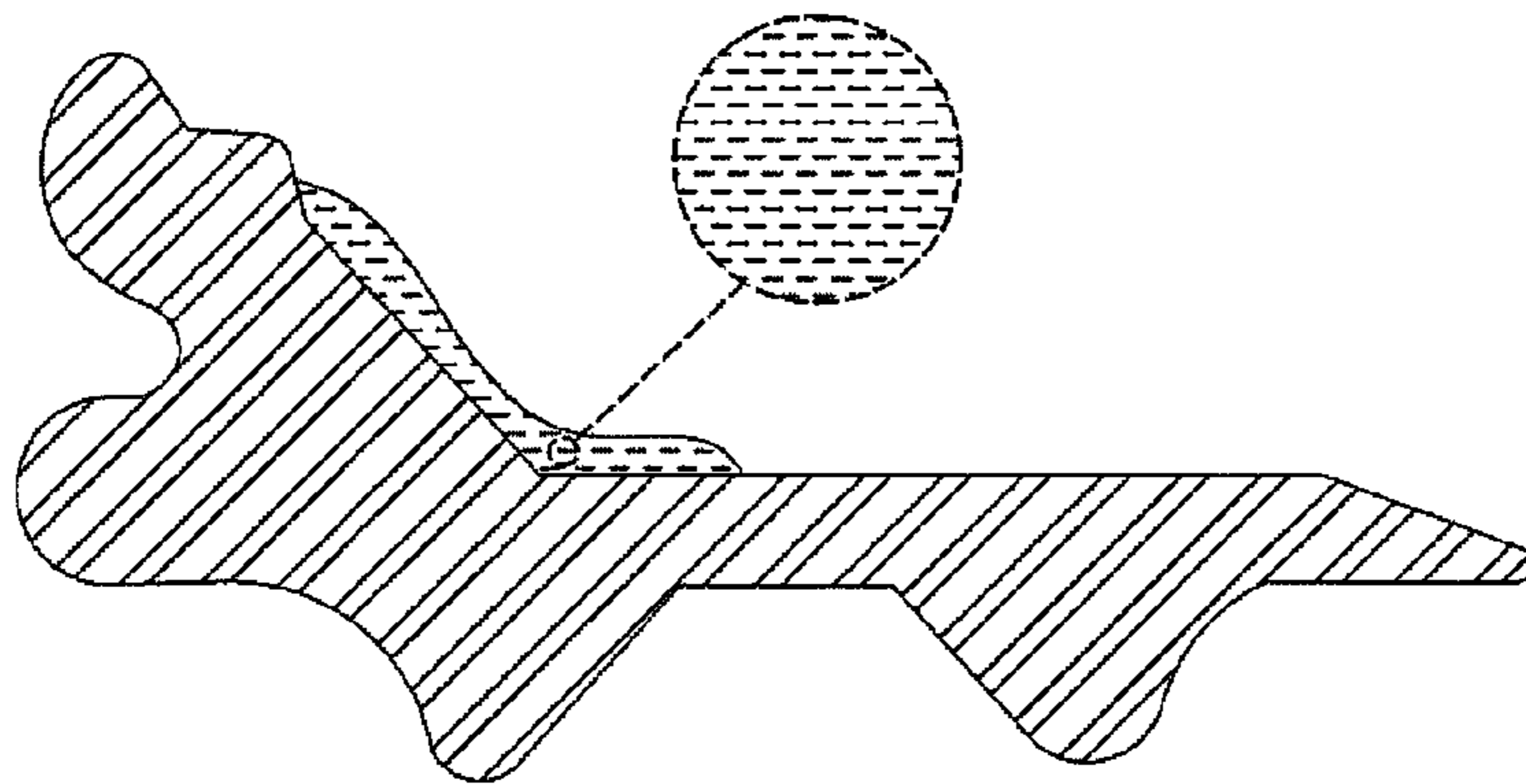

FIG. 48

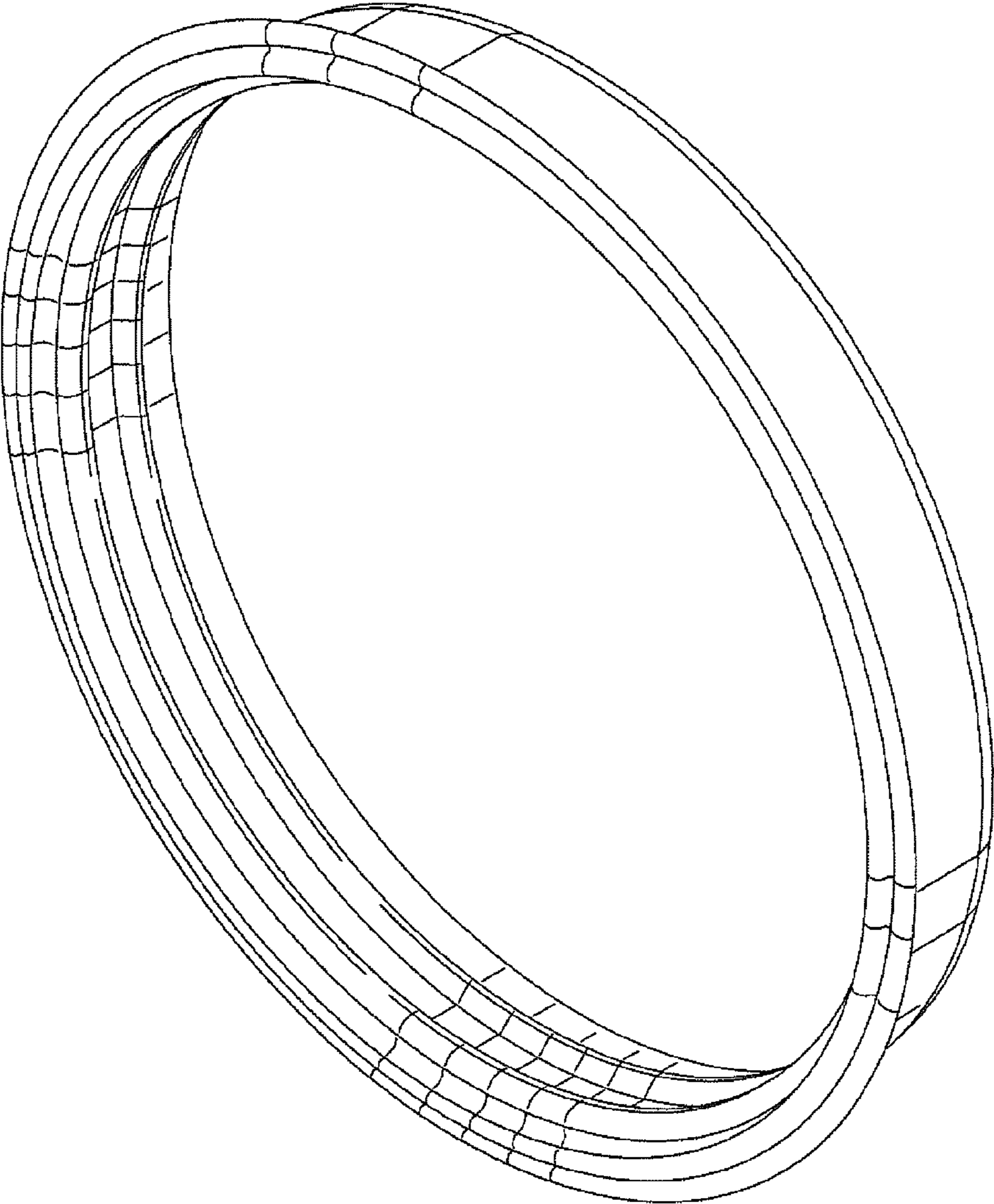

FIG. 49

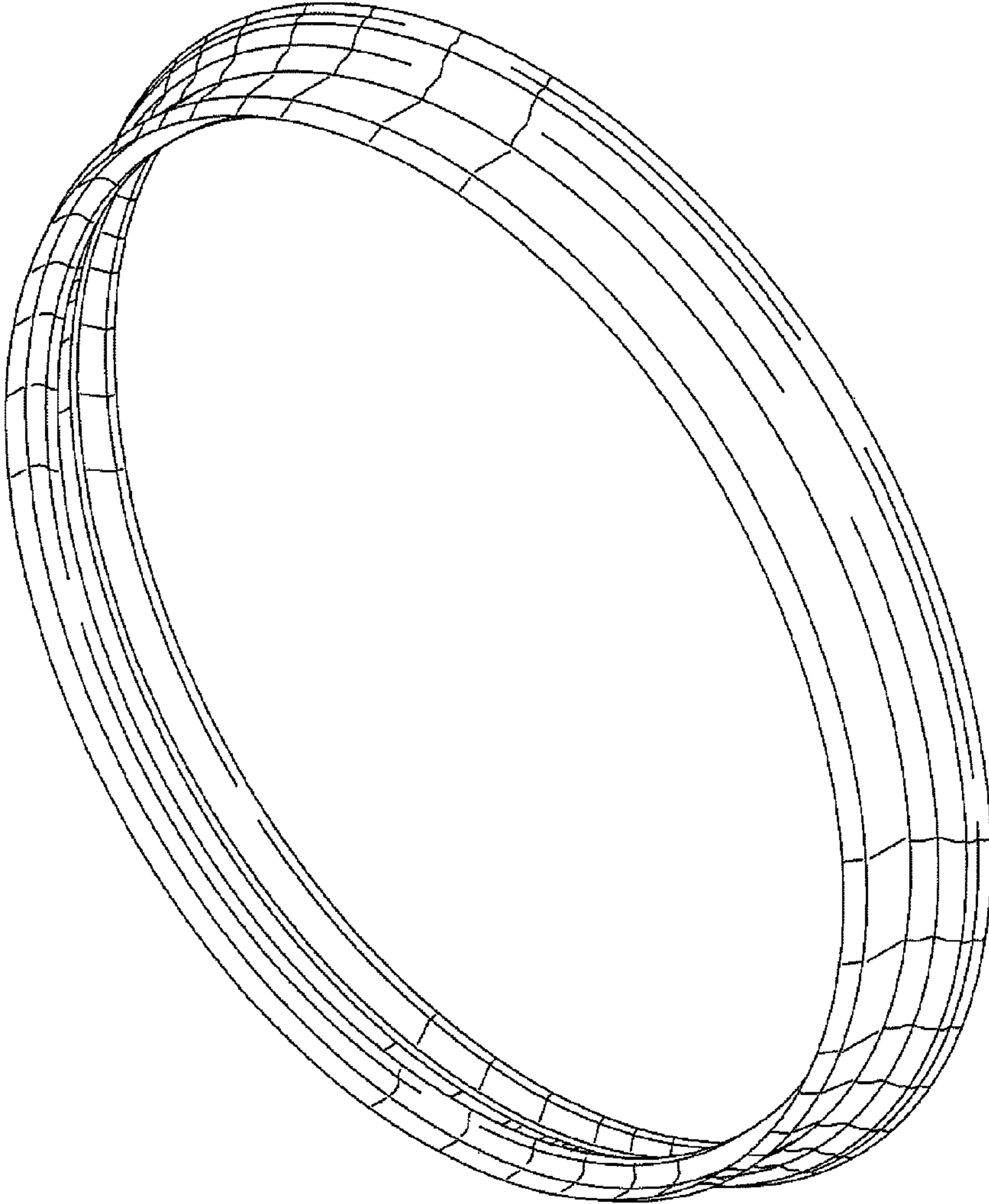

FIG. 50

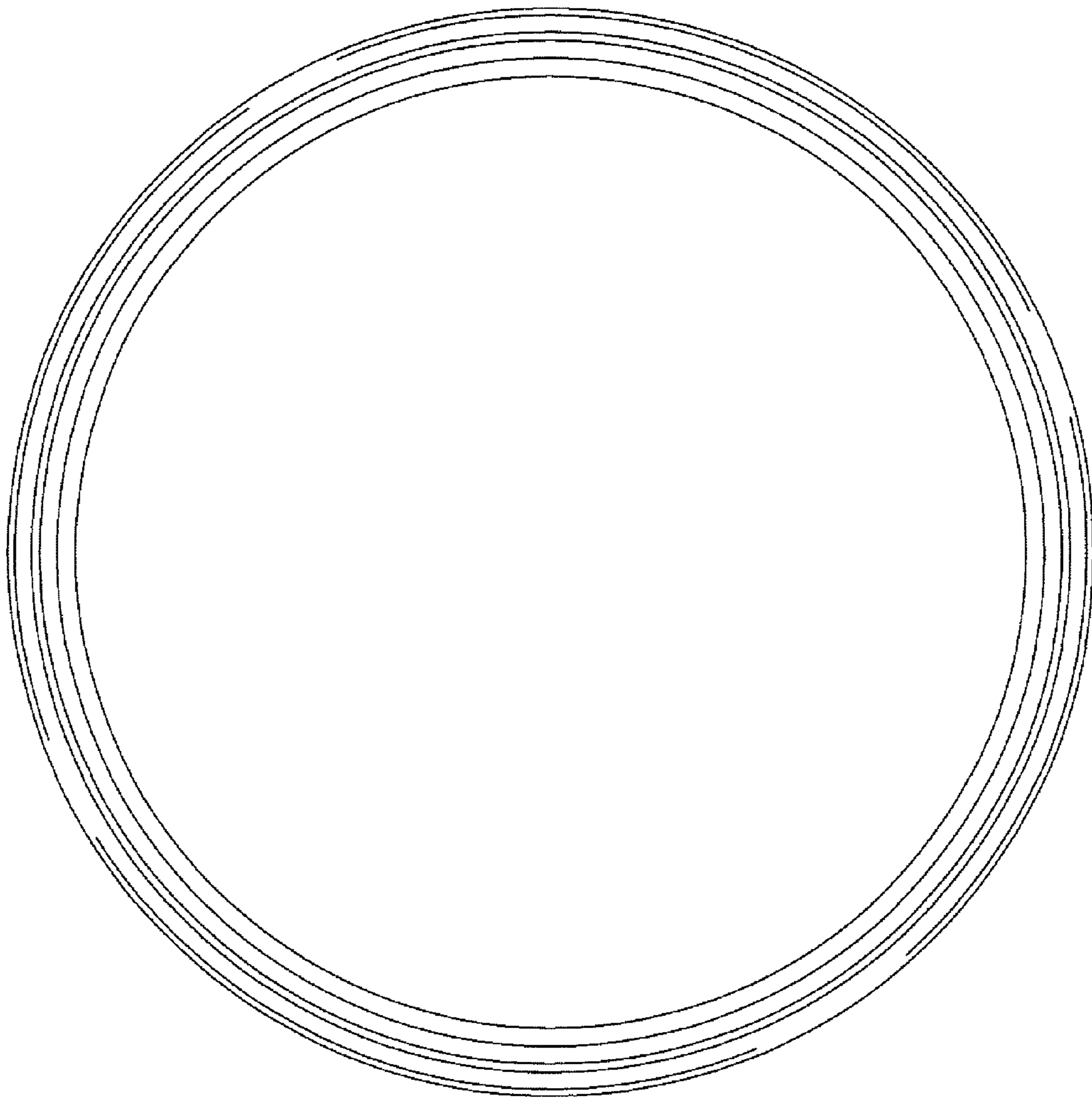

FIG. 51

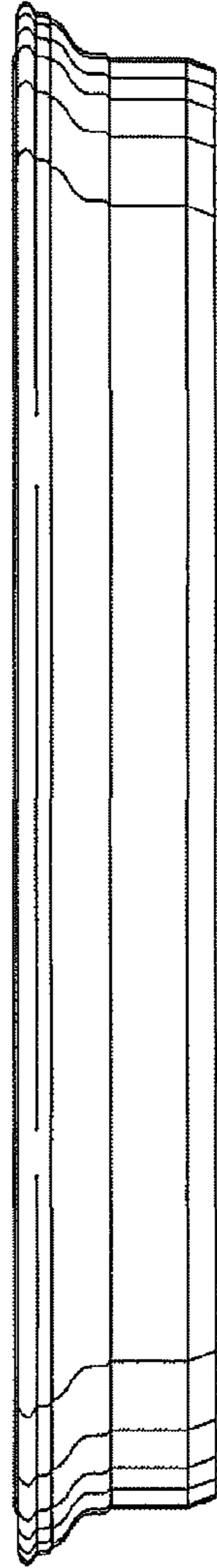

FIG. 52

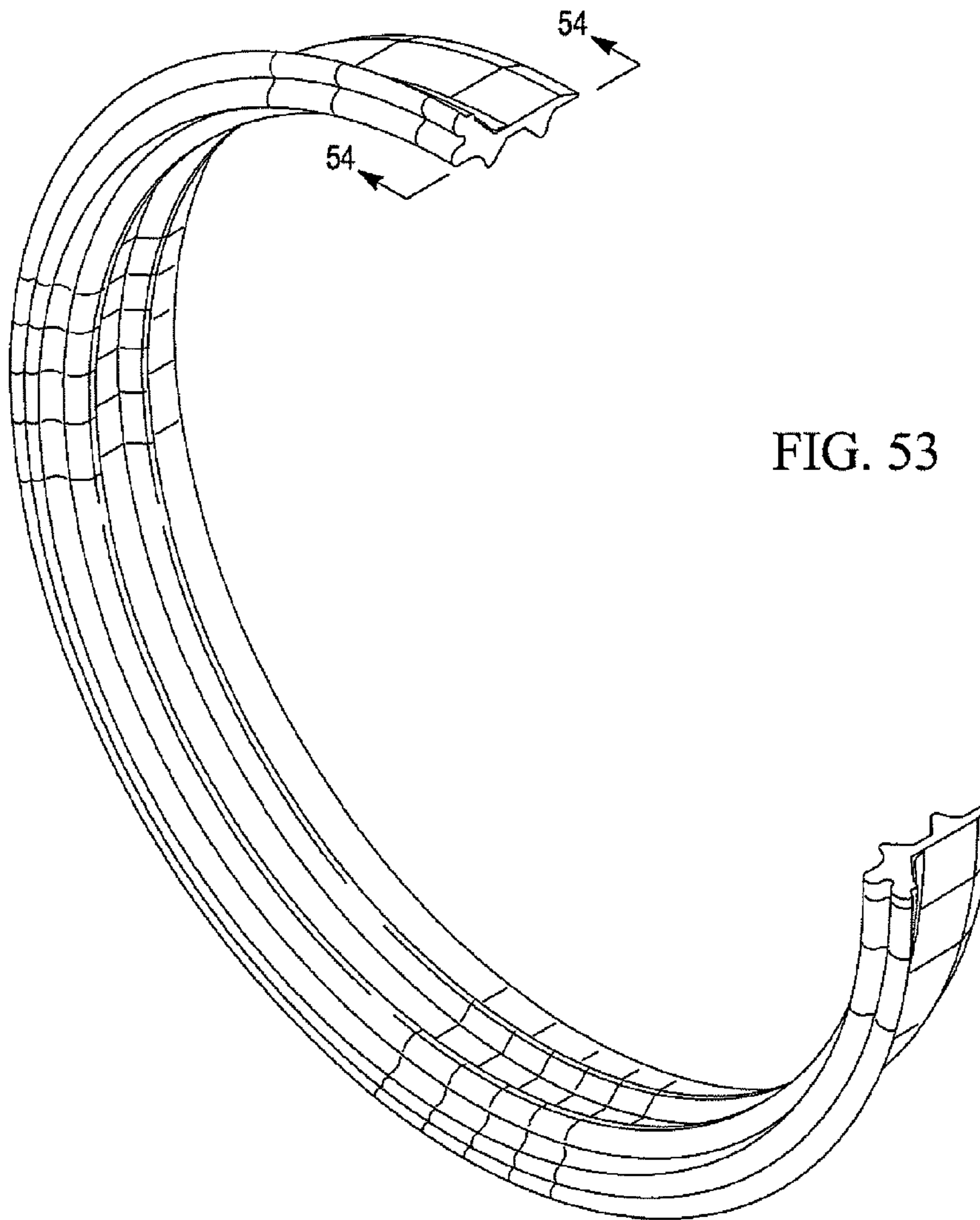

FIG. 53

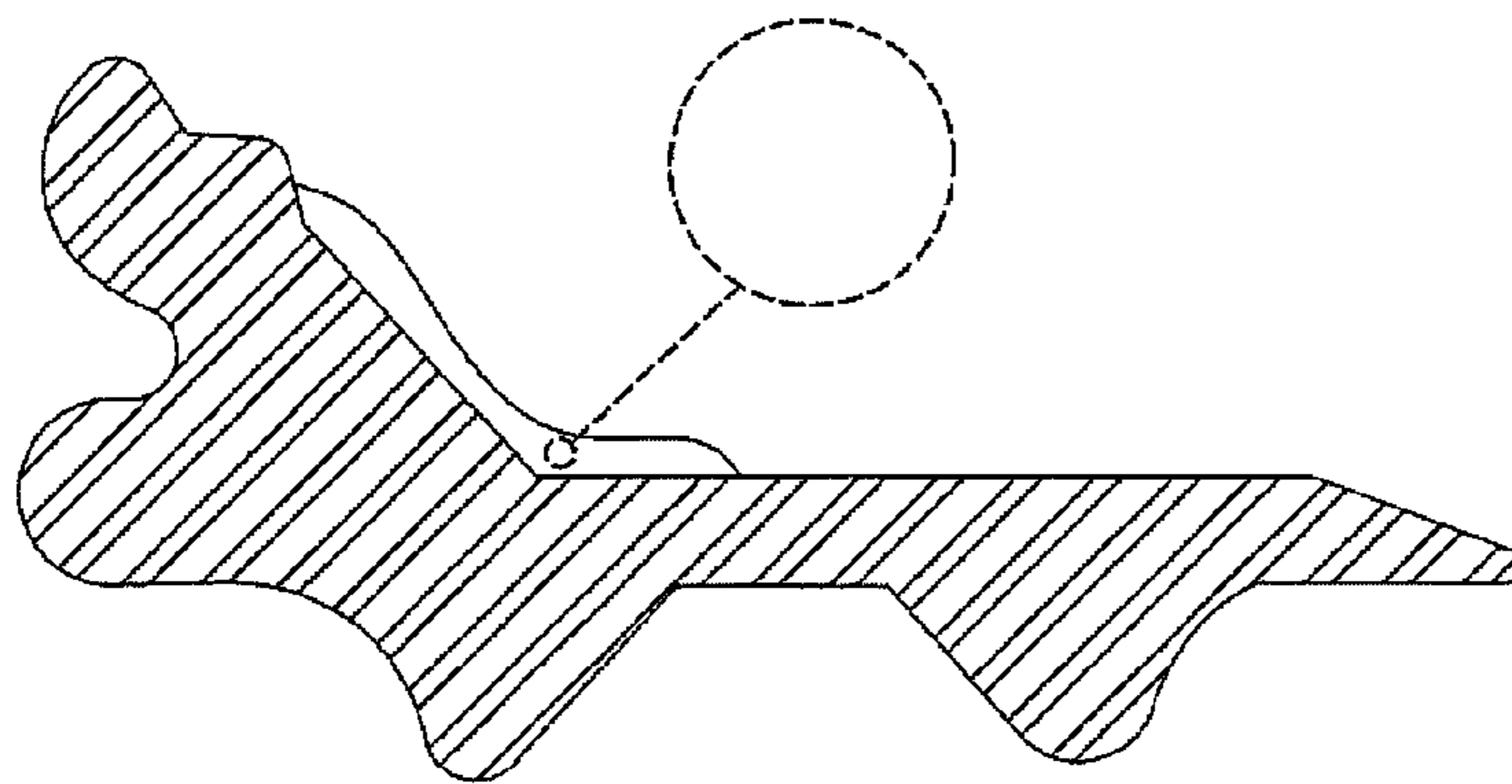

FIG. 54