



US00D706778S

(12) **United States Design Patent**
Kawasaki et al.

(10) **Patent No.:** **US D706,778 S**
(45) **Date of Patent:** **** Jun. 10, 2014**

(54) **BASE STATION**

(75) Inventors: **Takanori Kawasaki**, Tokyo (JP);
Kensuke Iizuka, Kawasaki (JP);
Kenichi Kimura, Kamakura (JP); **Hisao Morooka**, Kawasaki (JP)

(73) Assignee: **Fujitsu Limited**, Kawasaki (JP)

(**) Term: **14 Years**

(21) Appl. No.: **29/427,815**

(22) Filed: **Jul. 23, 2012**

(30) **Foreign Application Priority Data**

Jan. 23, 2012 (JP) D2012-001183

(51) **LOC (10) Cl.** **14-02**

(52) **U.S. Cl.**
USPC **D14/356**; D14/358

(58) **Field of Classification Search**
USPC D16/230; D14/358, 349, 351, 354-355,
D14/357, 432, 137, 155, 217, 227, 240, 242,
D14/496, 352, 356, 168, 188; D13/184;
369/24.01; 455/39, 500, 73, 78, 88,
455/347, 557, 560-561; 379/93.09, 93.15,
379/220.01, 156, 333-334, 338-339,
379/378.01, 399.01, 399.02, 413.02,
379/413.03, 413.04, 414, 900

See application file for complete search history.

(56) **References Cited**

U.S. PATENT DOCUMENTS

D314,770 S * 2/1991 Desbarats D14/140.2
D514,563 S * 2/2006 Kuramashi et al. D14/358
D579,931 S * 11/2008 Chang D14/242

D593,066 S * 5/2009 Sheba et al. D14/496
D627,345 S * 11/2010 Govindasamy et al. D14/356
D649,151 S * 11/2011 Ramones et al. D14/358
D649,548 S * 11/2011 Szoke et al. D14/358
D650,782 S * 12/2011 Hogan D14/358
8,228,670 B2 * 7/2012 Fahey et al. 455/556.1
D669,060 S * 10/2012 Huang D14/240
D671,100 S * 11/2012 Huang D14/242
D682,829 S * 5/2013 Wu et al. D14/358

OTHER PUBLICATIONS

U.S. Appl. No. 29/427,816, filed Jul. 23, 2012, Takanori Kawasaki et al., Fujitsu Limited.

* cited by examiner

Primary Examiner — Wan Laymon

(74) *Attorney, Agent, or Firm* — Staas & Halsey LLP

(57) **CLAIM**

The ornamental design for a base station, as shown and described.

DESCRIPTION

FIG. 1 is a perspective view of front, top and right side of a base station showing our new design;
FIG. 2 is a perspective view of rear, top and left side thereof;
FIG. 3 is a front view thereof;
FIG. 4 is a rear view thereof;
FIG. 5 is a left side view thereof;
FIG. 6 is a right side view thereof;
FIG. 7 is a top view thereof; and,
FIG. 8 is a bottom view thereof.

The broken lines in FIG. 4 are included for the purpose of illustrating unclaimed portions of the base station and form no part of the claimed design.

1 Claim, 6 Drawing Sheets

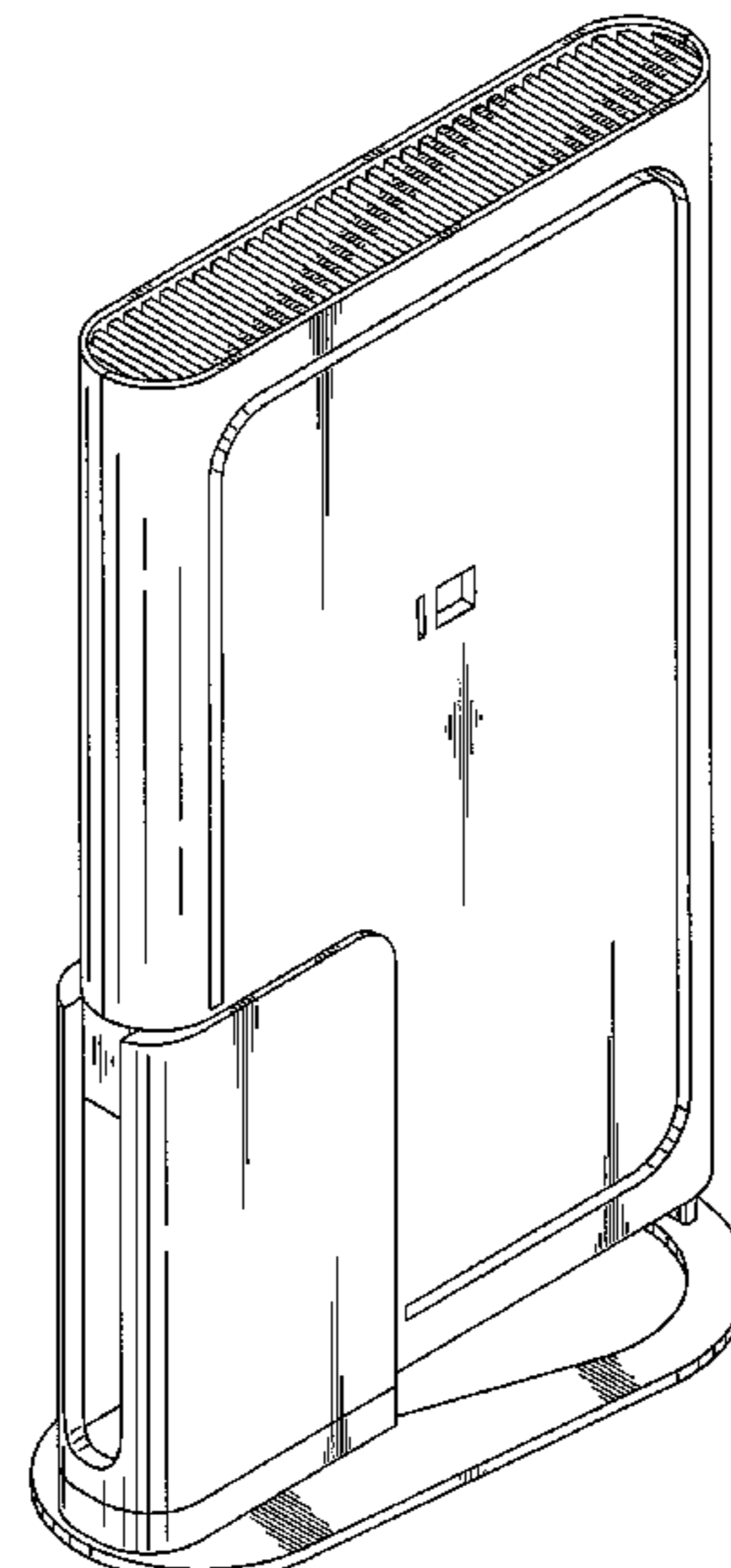
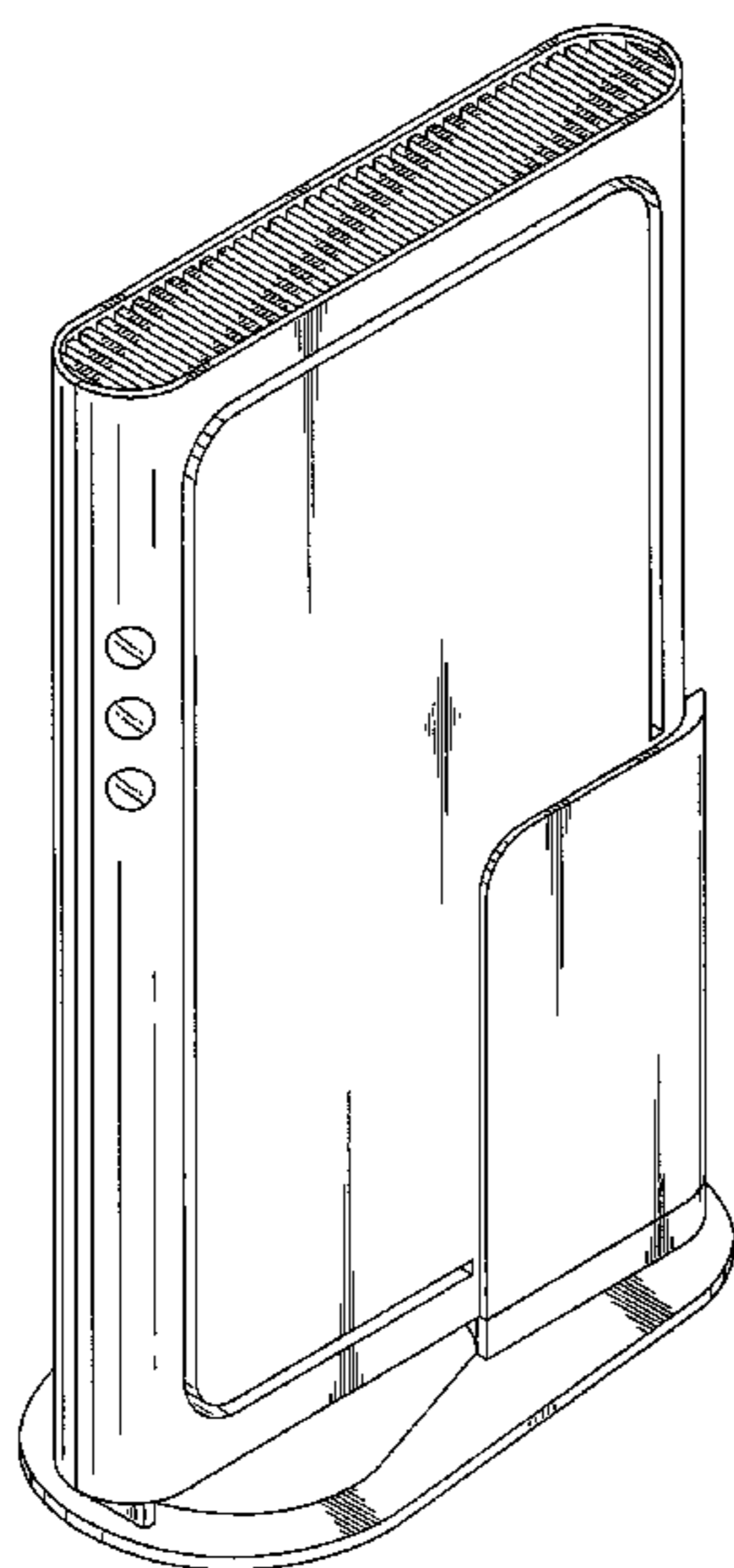

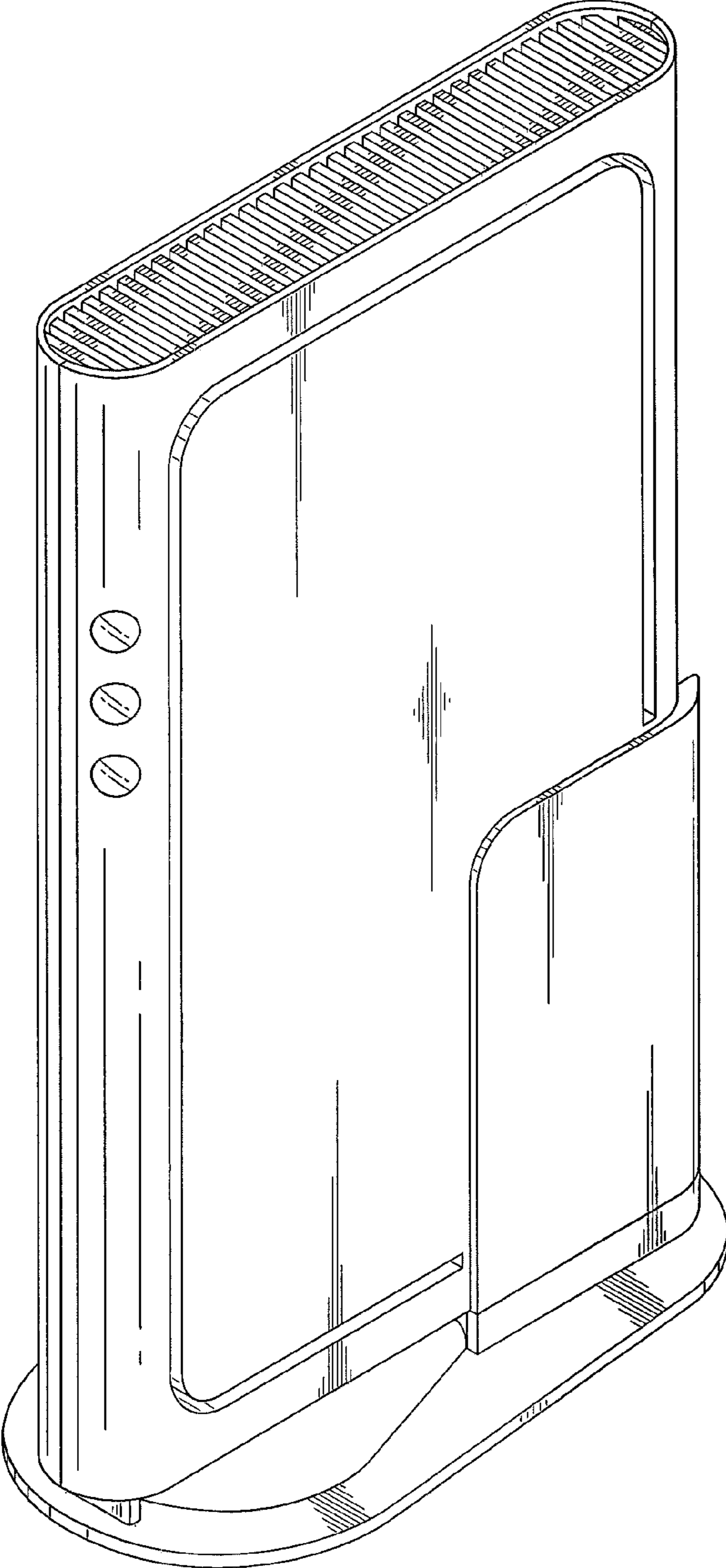

FIG. 1

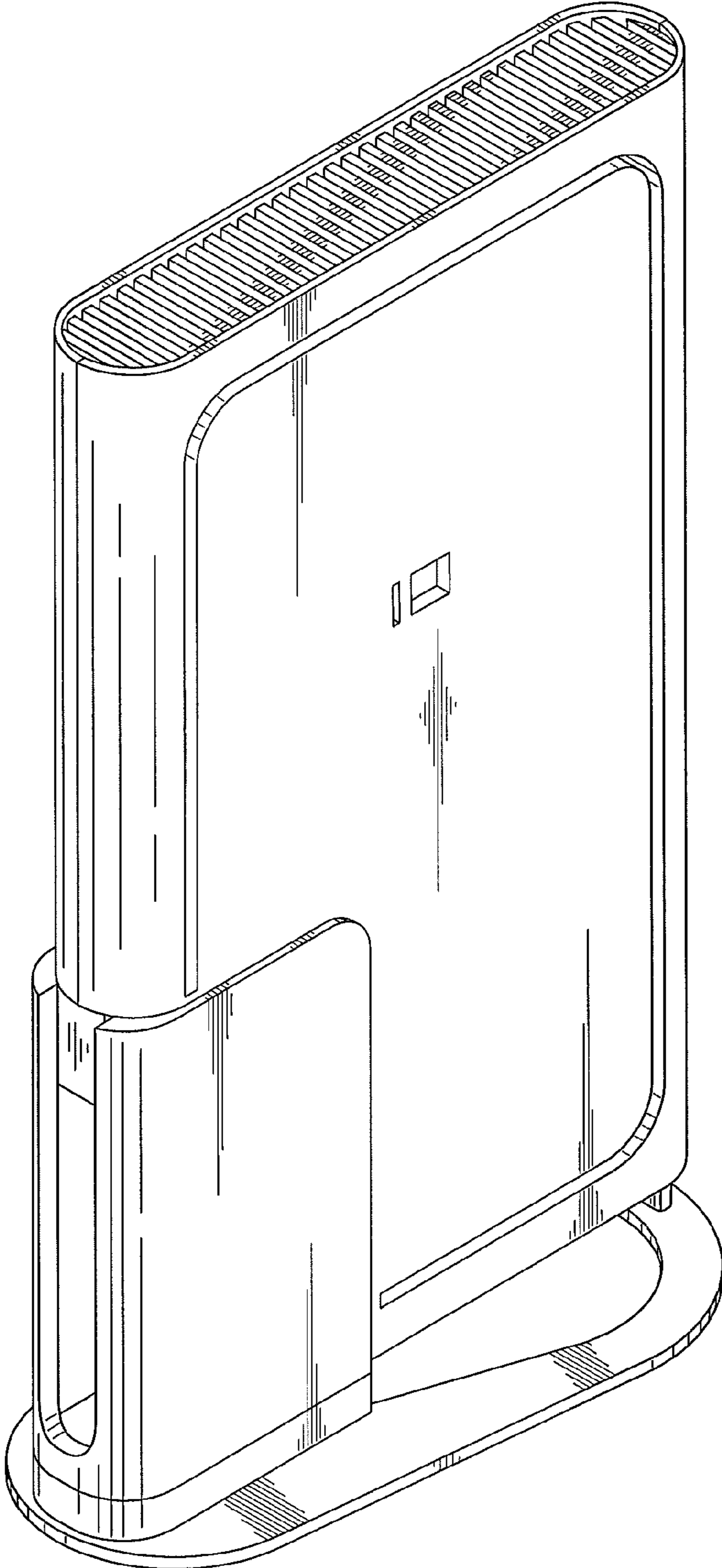

FIG. 2

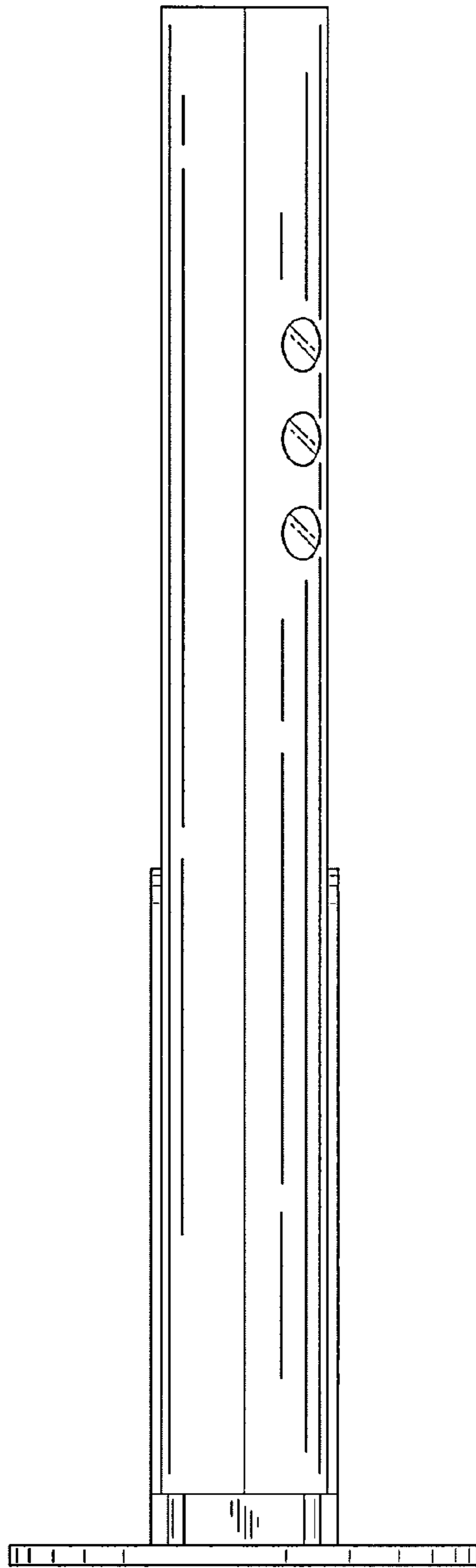

FIG. 3

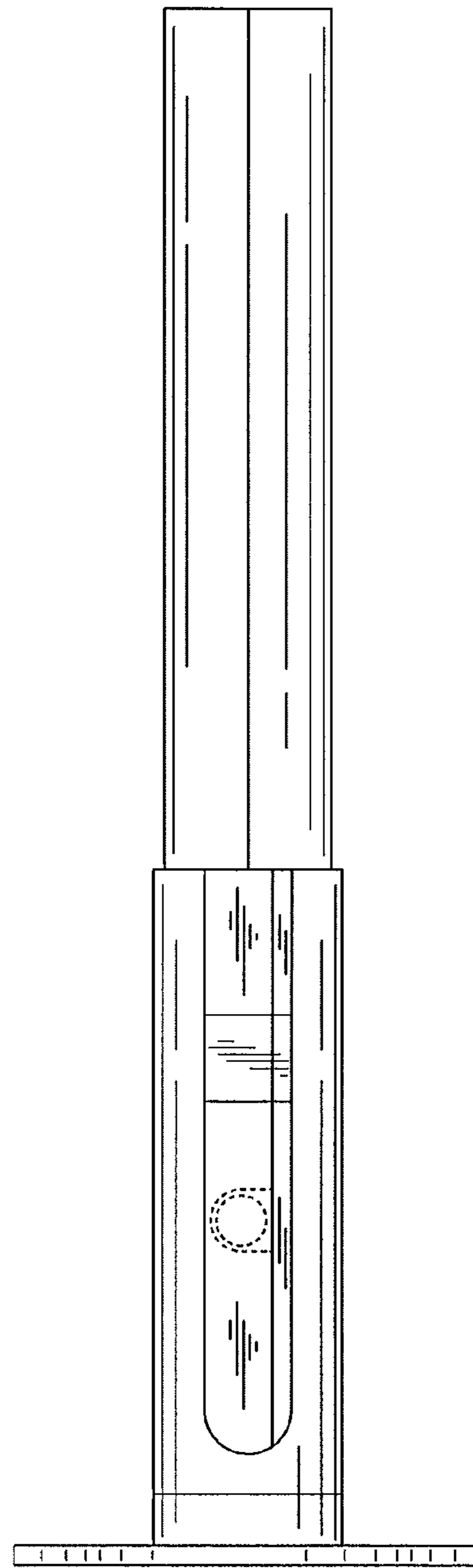

FIG. 4

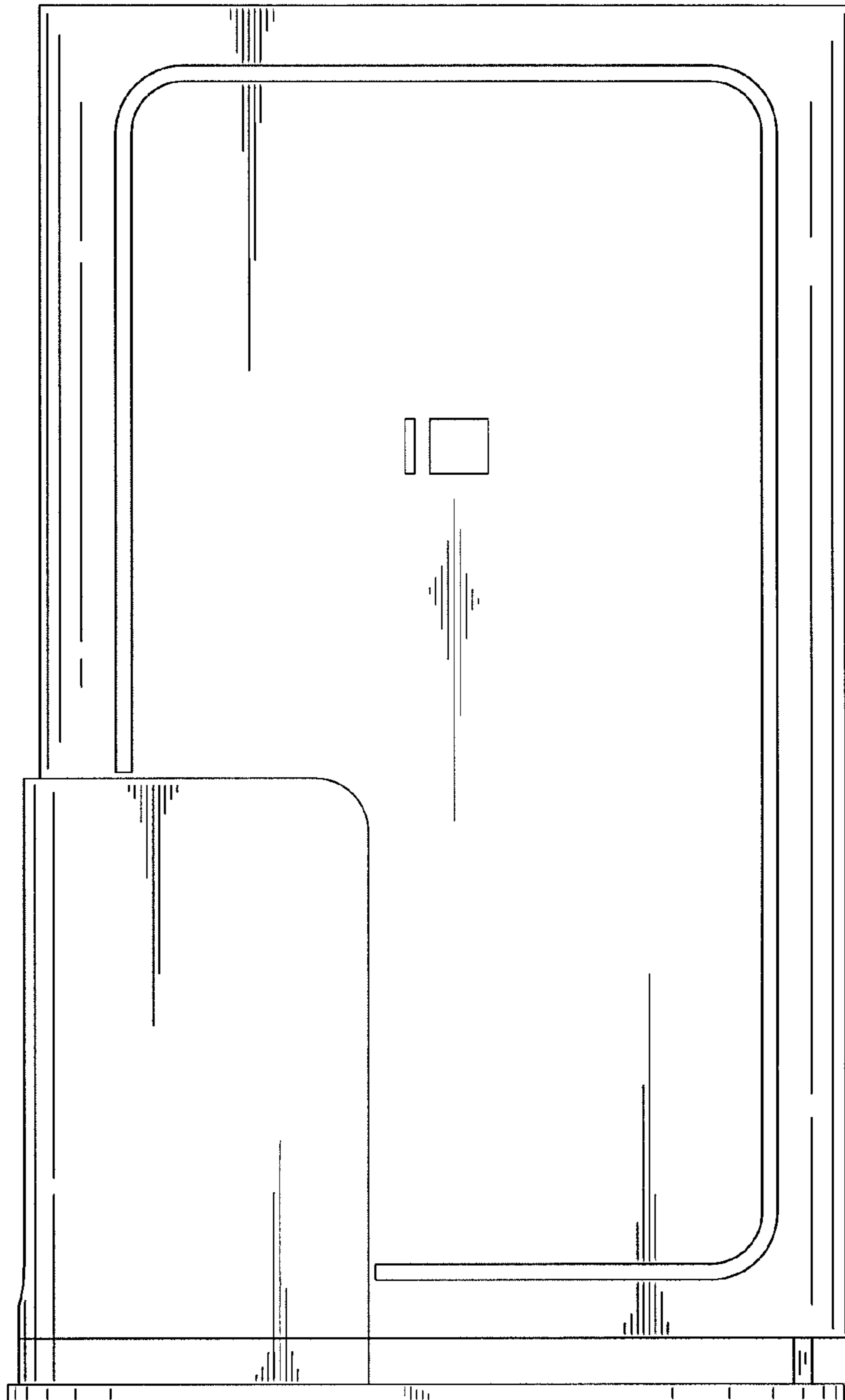

FIG. 5

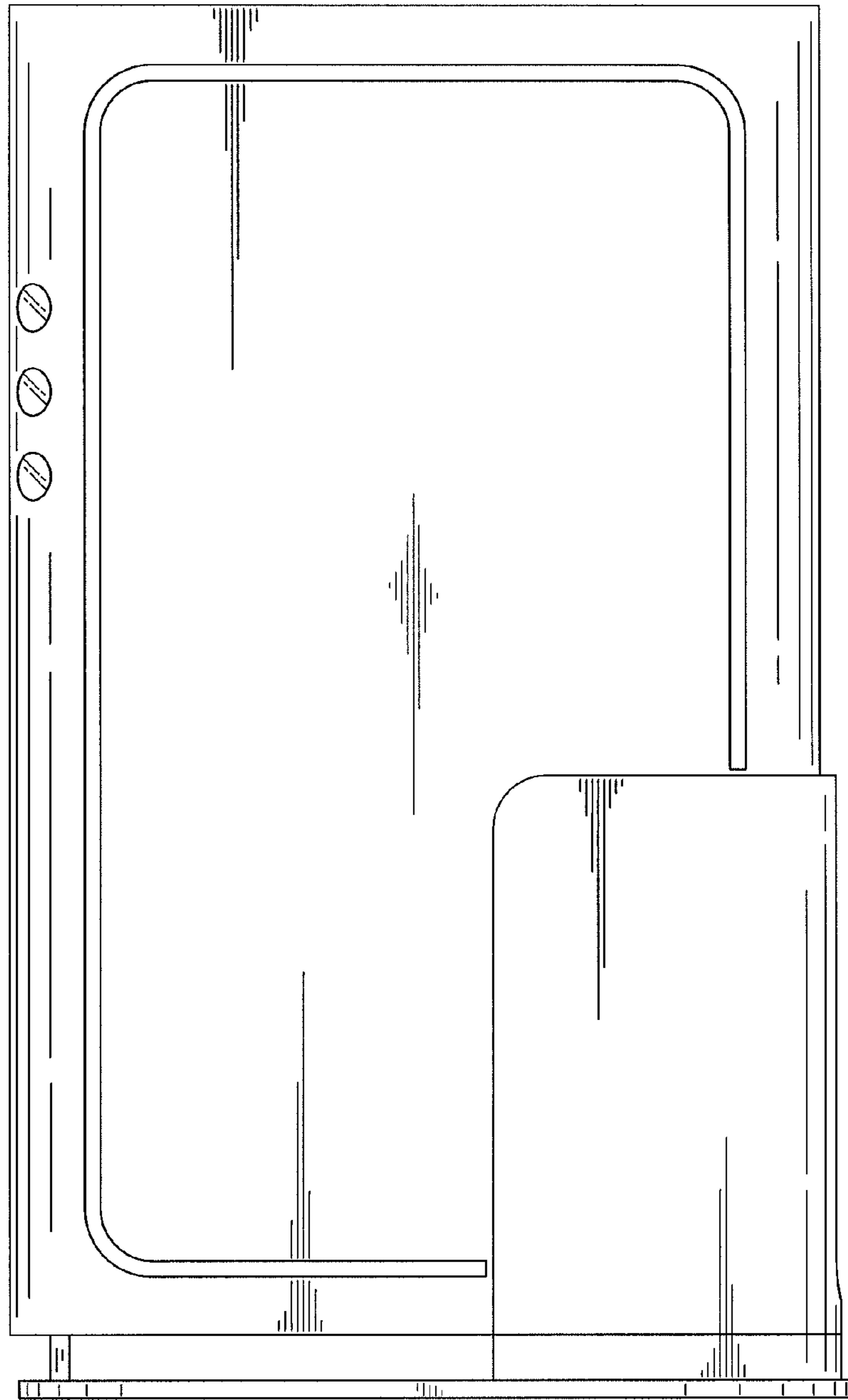

FIG. 6

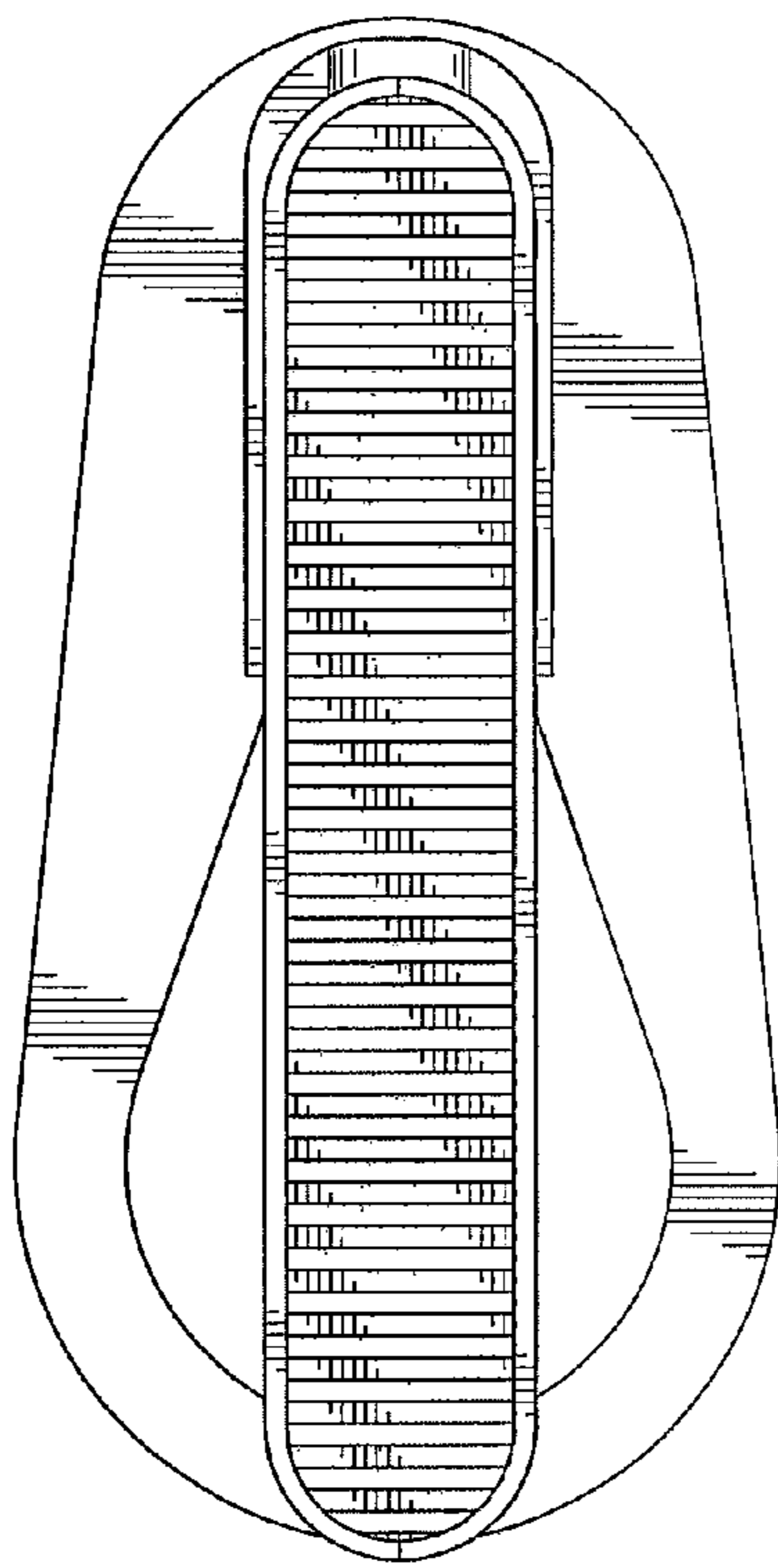

FIG. 7

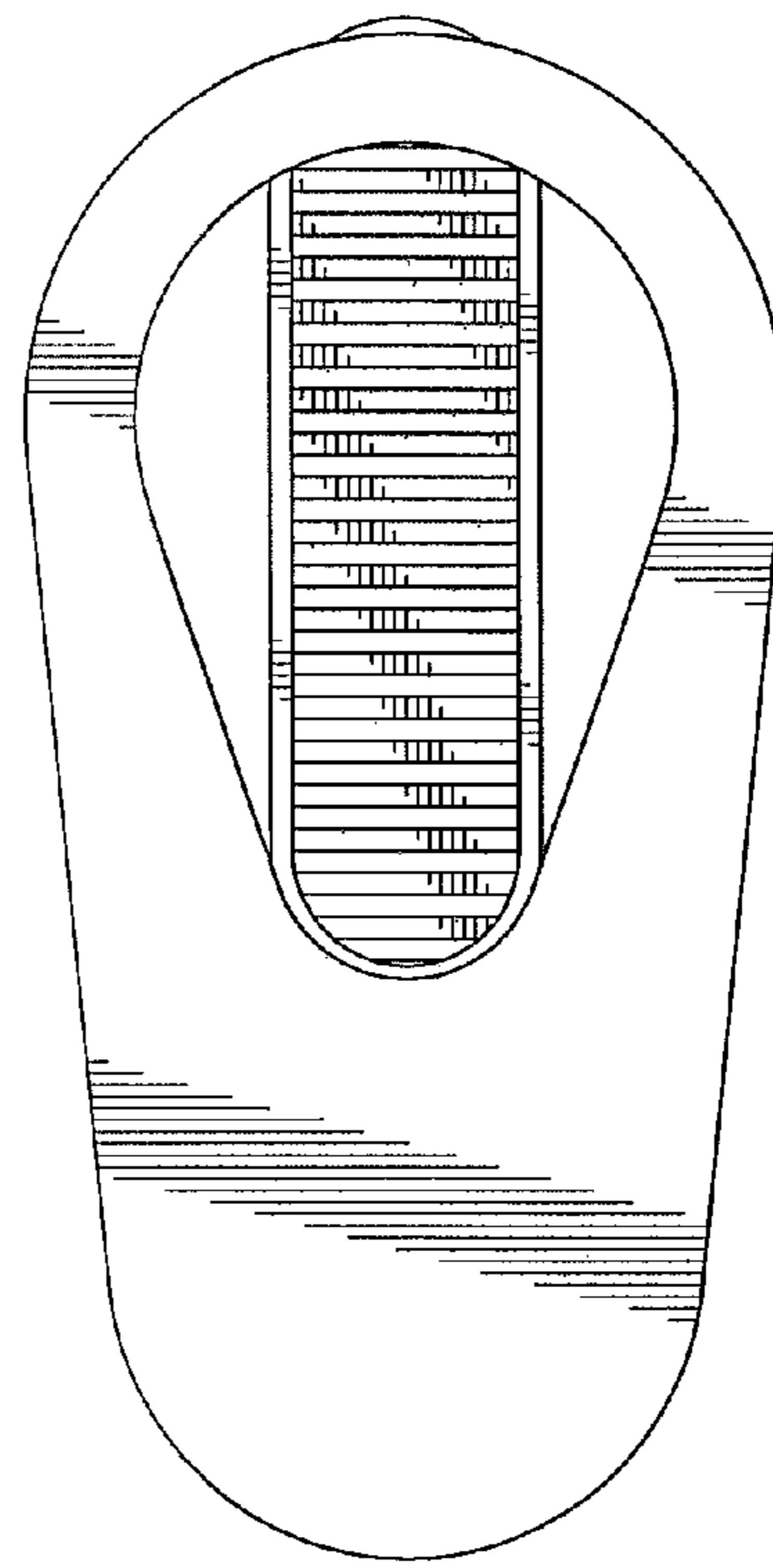

FIG. 8