

US00D706688S

(12) **United States Design Patent**
Baldwin

(10) **Patent No.:** **US D706,688 S**
(45) **Date of Patent:** **** Jun. 10, 2014**

(54) **TRAILER HITCH WITH BOOT PULLING FEATURE**

(71) Applicant: **Amber Baldwin**, Pineville, LA (US)

(72) Inventor: **Amber Baldwin**, Pineville, LA (US)

(**) Term: **14 Years**

(21) Appl. No.: **29/468,510**

(22) Filed: **Oct. 1, 2013**

Related U.S. Application Data

(63) Continuation of application No. 13/568,640, filed on Aug. 7, 2012, now abandoned.

(51) **LOC (10) Cl.** **12-16**

(52) **U.S. Cl.**
USPC **D12/162**

(58) **Field of Classification Search**
USPC D12/162, 159, 161, 160; 56/DIG. 14; 37/399; 280/406.2, 407, 407.1, 408, 280/411.1, 416.1, 416.2, 416.3, 418, 418.1, 280/433, 434, 435, 441.1, 441.2, 455.1, 280/456.1, 480, 493, 504, 507, 508; 224/42.11, 42.12, 42.14, 42.26, 400, 224/401, 412, 413, 488, 494, 500-501, 519, 224/537; 135/88.05; 150/166

See application file for complete search history.

(56) **References Cited**

U.S. PATENT DOCUMENTS

346,682 A 8/1886 Quinlan
846,694 A 3/1907 Paul

3,784,067 A	1/1974	Hicks	
4,355,744 A	10/1982	Dudley	
4,394,946 A	7/1983	McCormick	
D320,109 S	9/1991	Chew	
5,152,439 A	10/1992	Simons	
D358,570 S *	5/1995	Doherty et al.	D12/162
5,566,868 A	10/1996	Mariscal et al.	
D412,771 S	8/1999	Kelley	
6,634,667 B1 *	10/2003	Tozer	280/514
6,712,381 B1 *	3/2004	Moss	280/491.1
6,745,926 B2 *	6/2004	Chimenti	224/509
7,044,493 B1 *	5/2006	Wilson	280/489
7,338,064 B1 *	3/2008	Williams	280/491.3
7,819,128 B2 *	10/2010	Clark et al.	135/88.08
2007/0102898 A1 *	5/2007	Schulze	280/507
2007/0145716 A1 *	6/2007	Schulze	280/483
2011/0156369 A1 *	6/2011	Schroder	280/491.1

* cited by examiner

Primary Examiner — Katrina A Betton

(74) *Attorney, Agent, or Firm* — Robert C. Montgomery; Montgomery Patent & Design

(57) **CLAIM**

The ornamental design for a trailer hitch with boot pulling feature, as shown and described.

DESCRIPTION

FIG. 1 is a perspective view of a trailer hitch with boot pulling feature;

FIG. 2 is a front view thereof;

FIG. 3 is a rear view thereof;

FIG. 4 is a left-hand side view thereof;

FIG. 5 is a right-hand side view thereof;

FIG. 6 is a top view thereof; and,

FIG. 7 is a bottom view thereof.

1 Claim, 7 Drawing Sheets

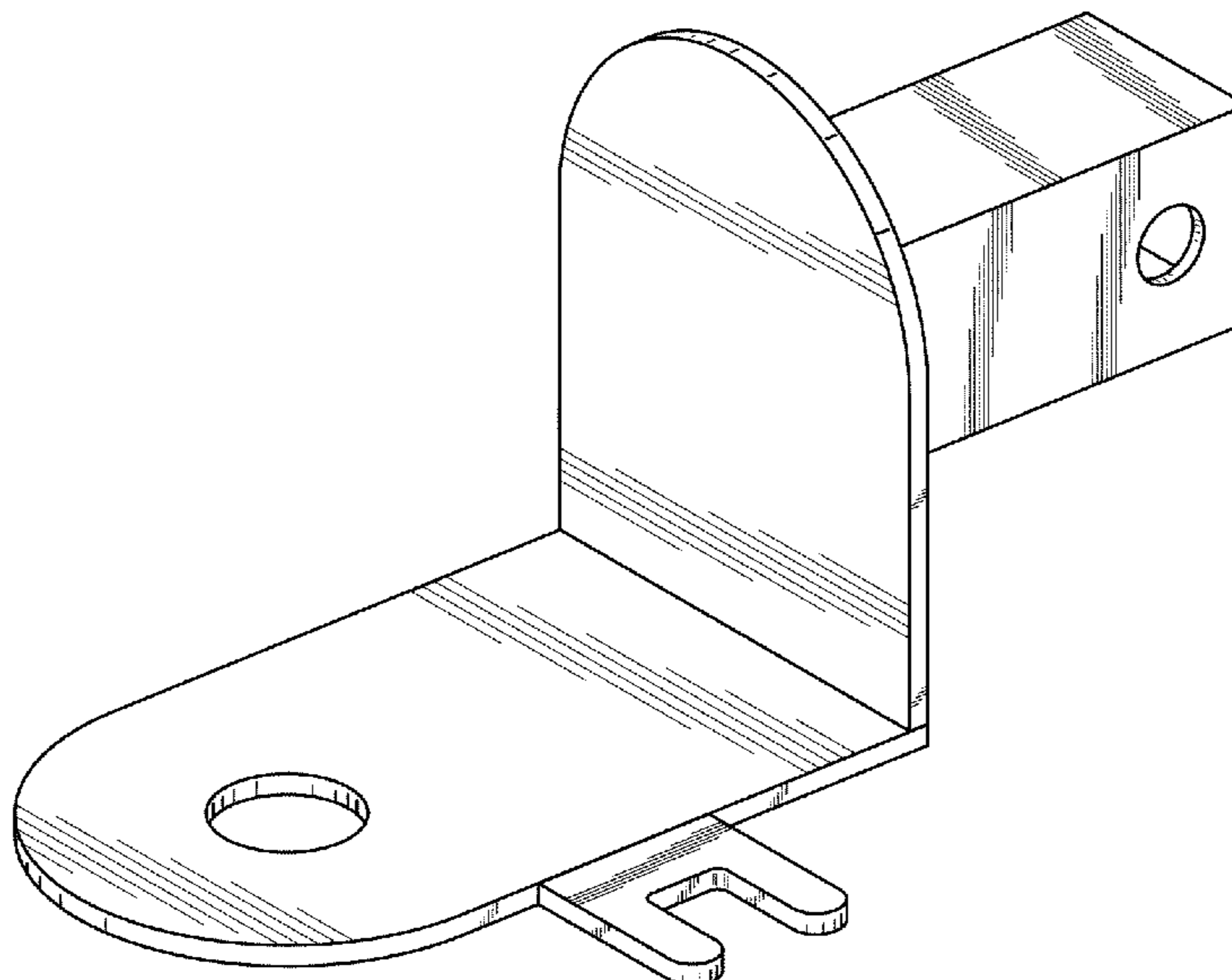

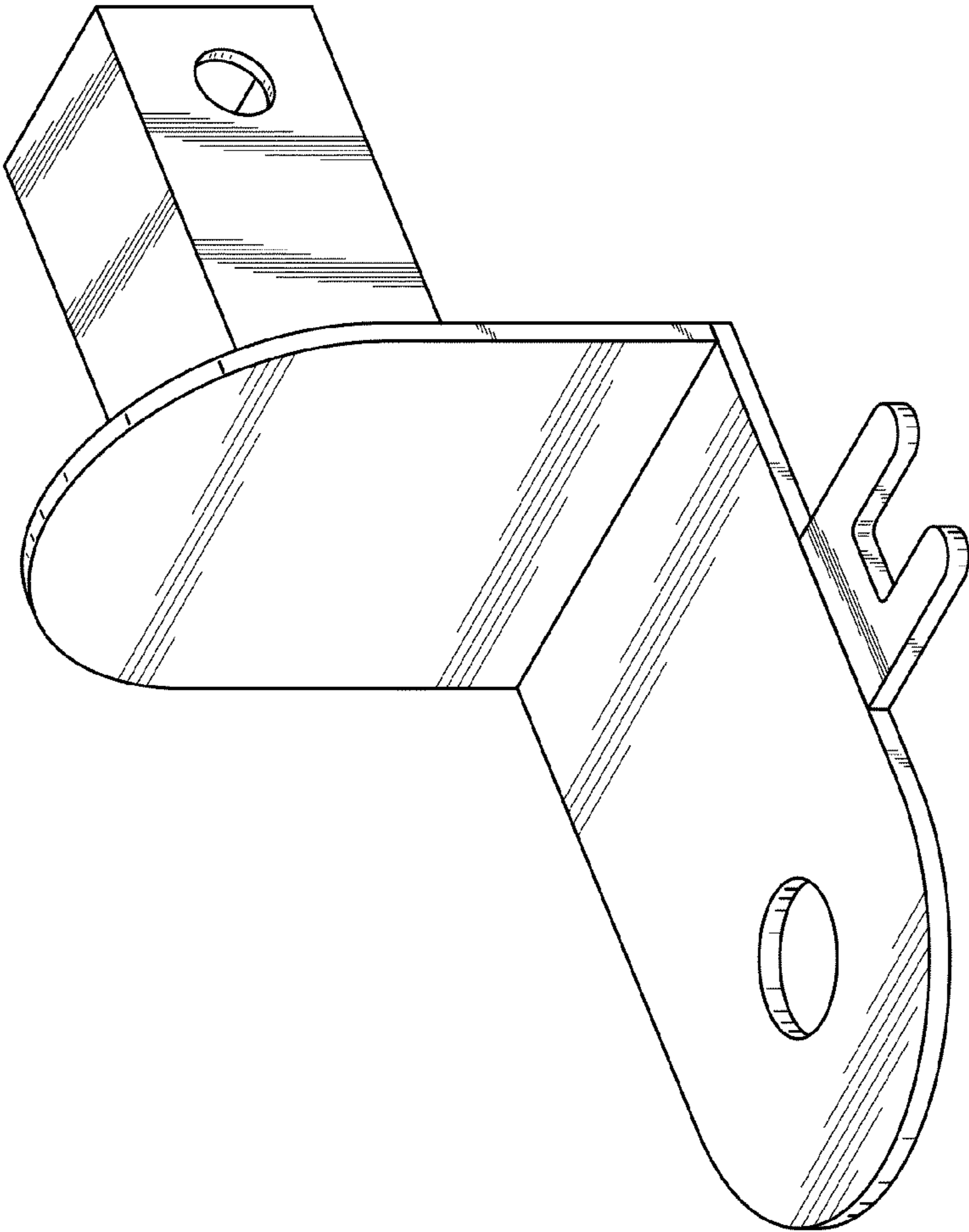

Fig. 1

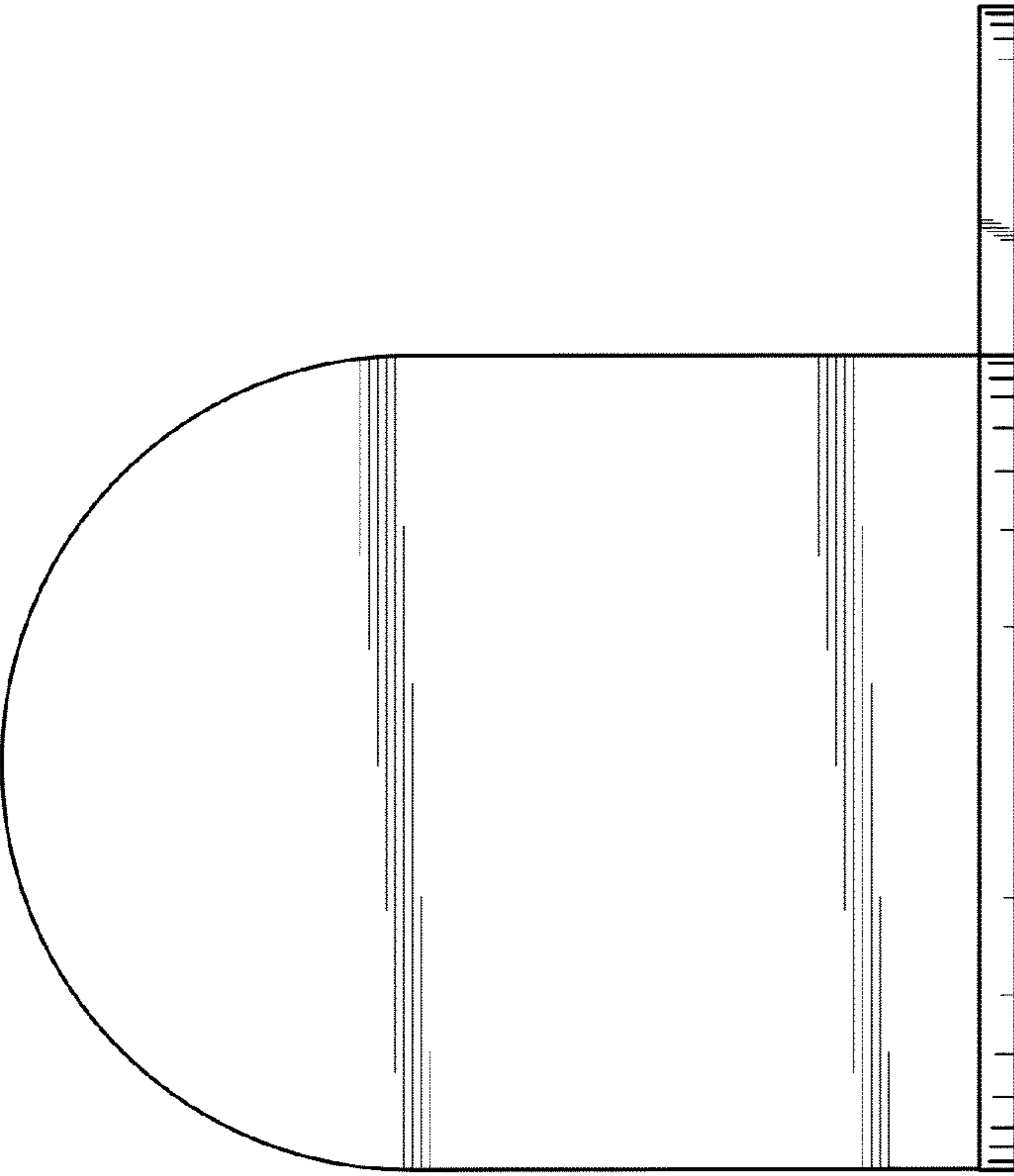

Fig. 2

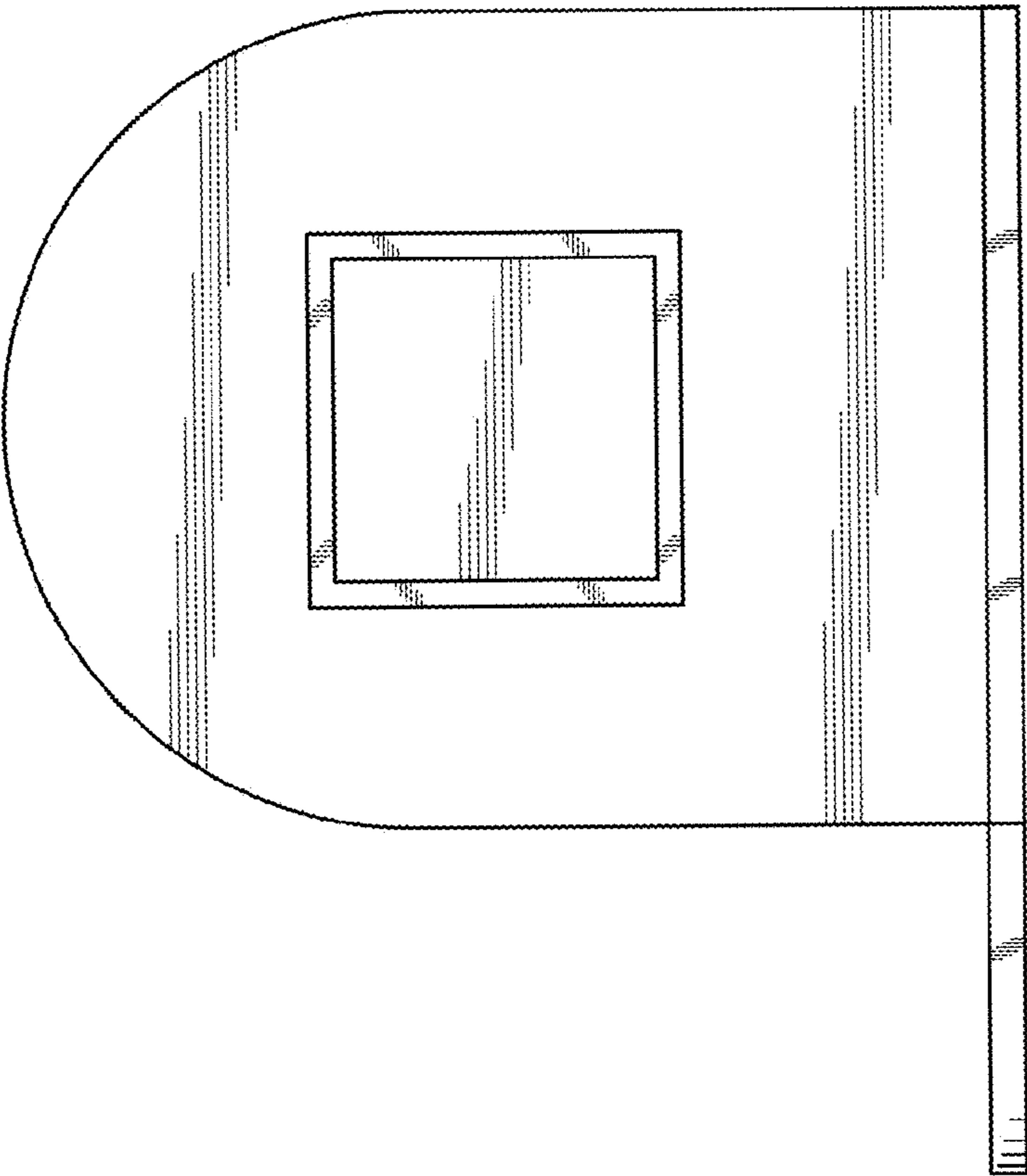

Fig. 3

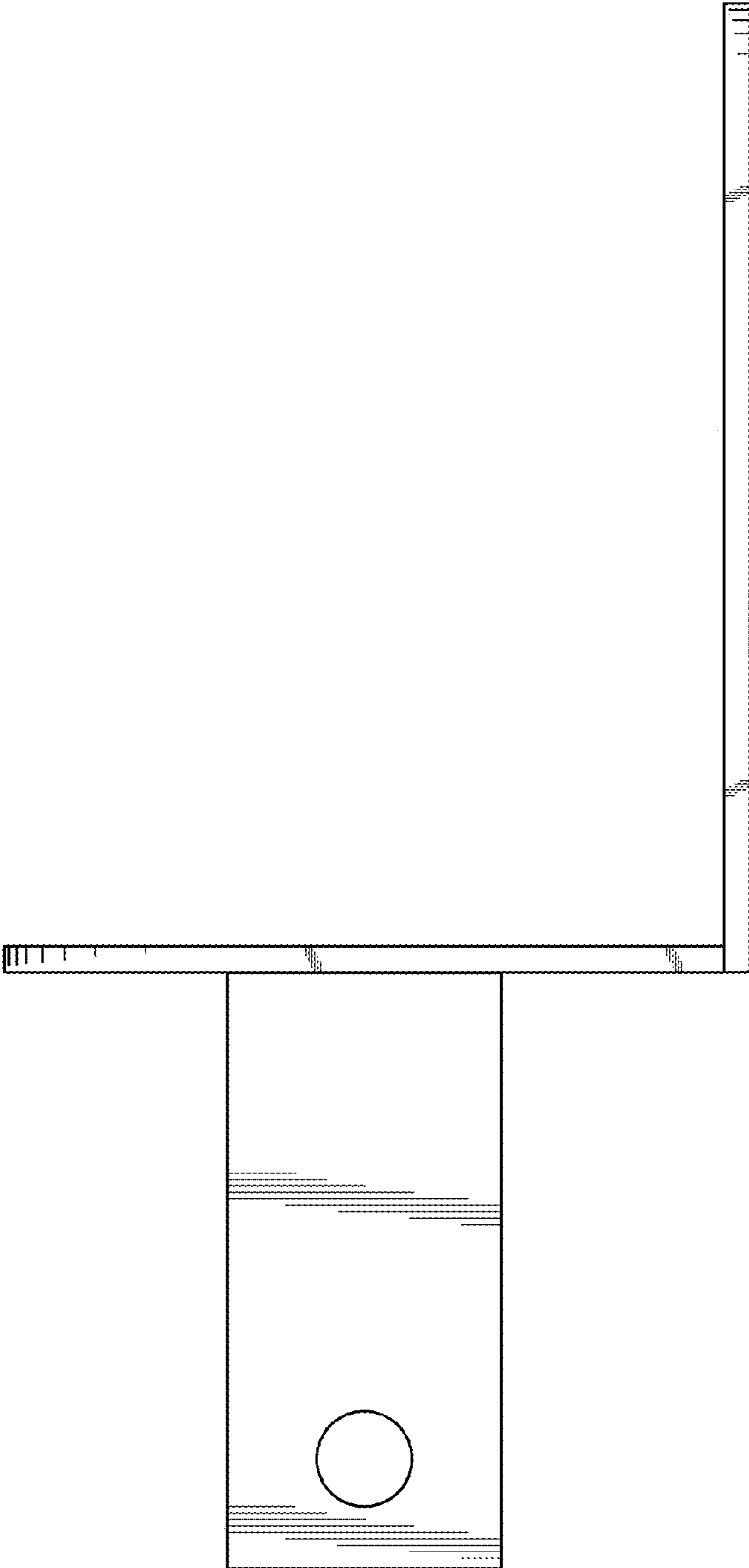

Fig. 4

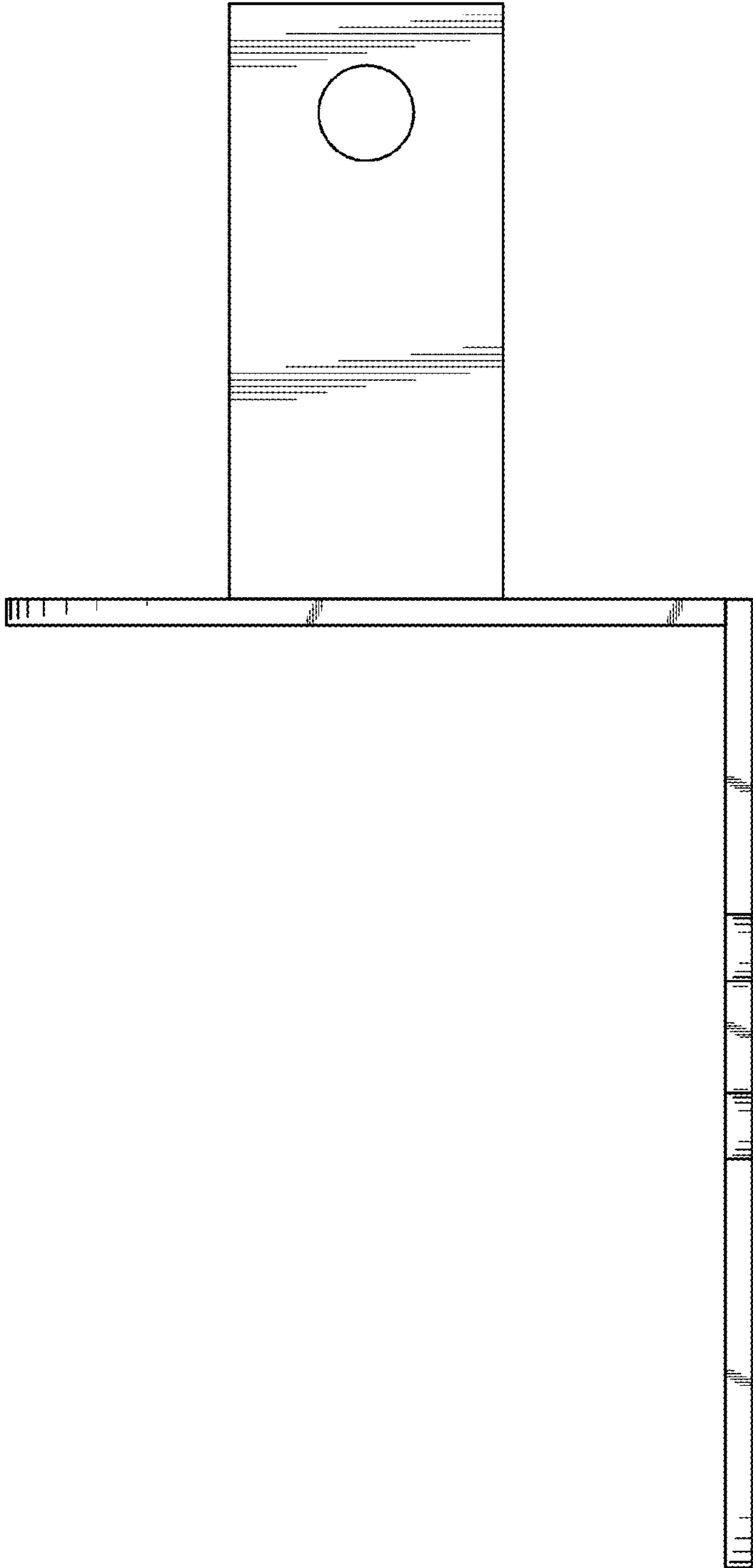

Fig. 5

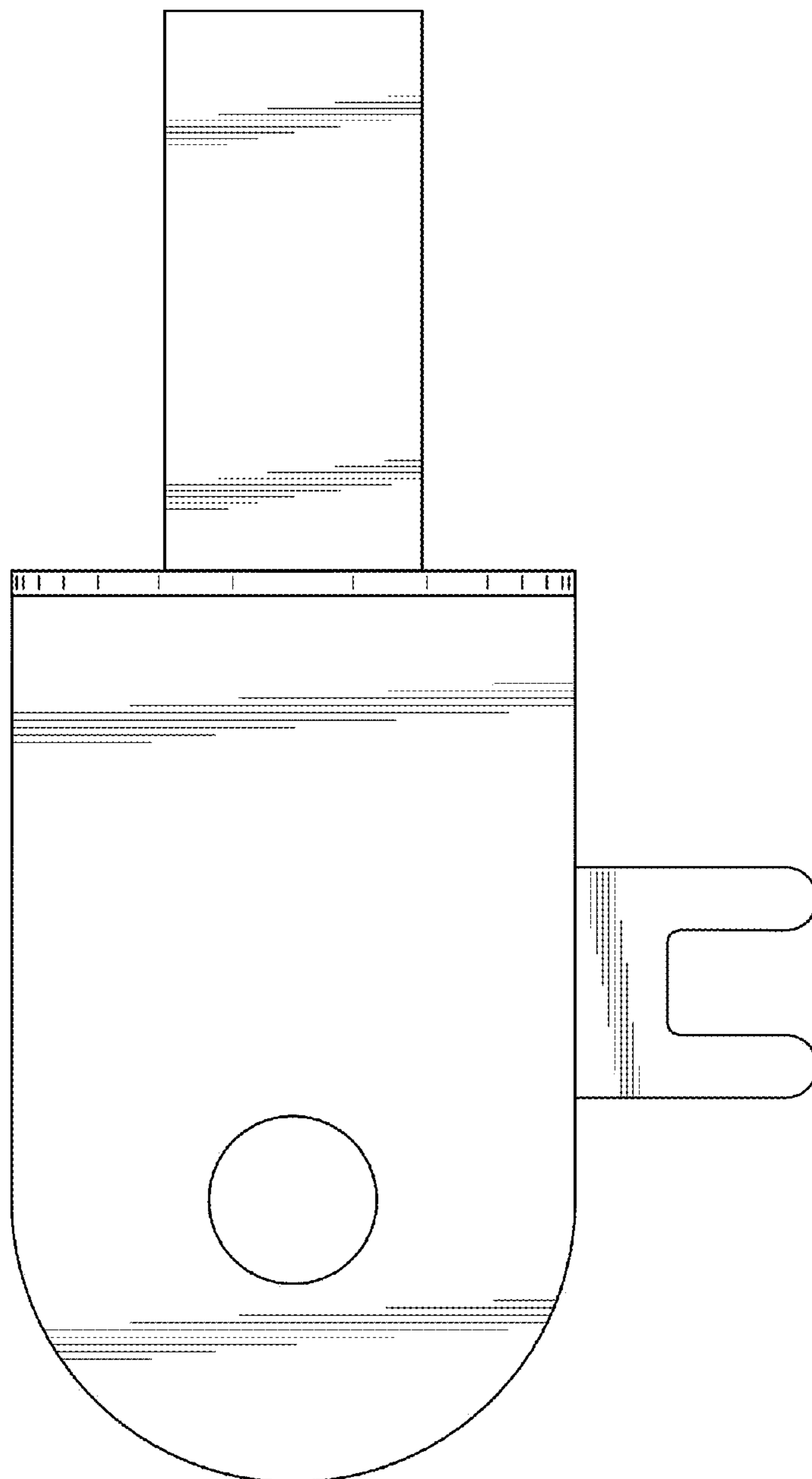

Fig. 6

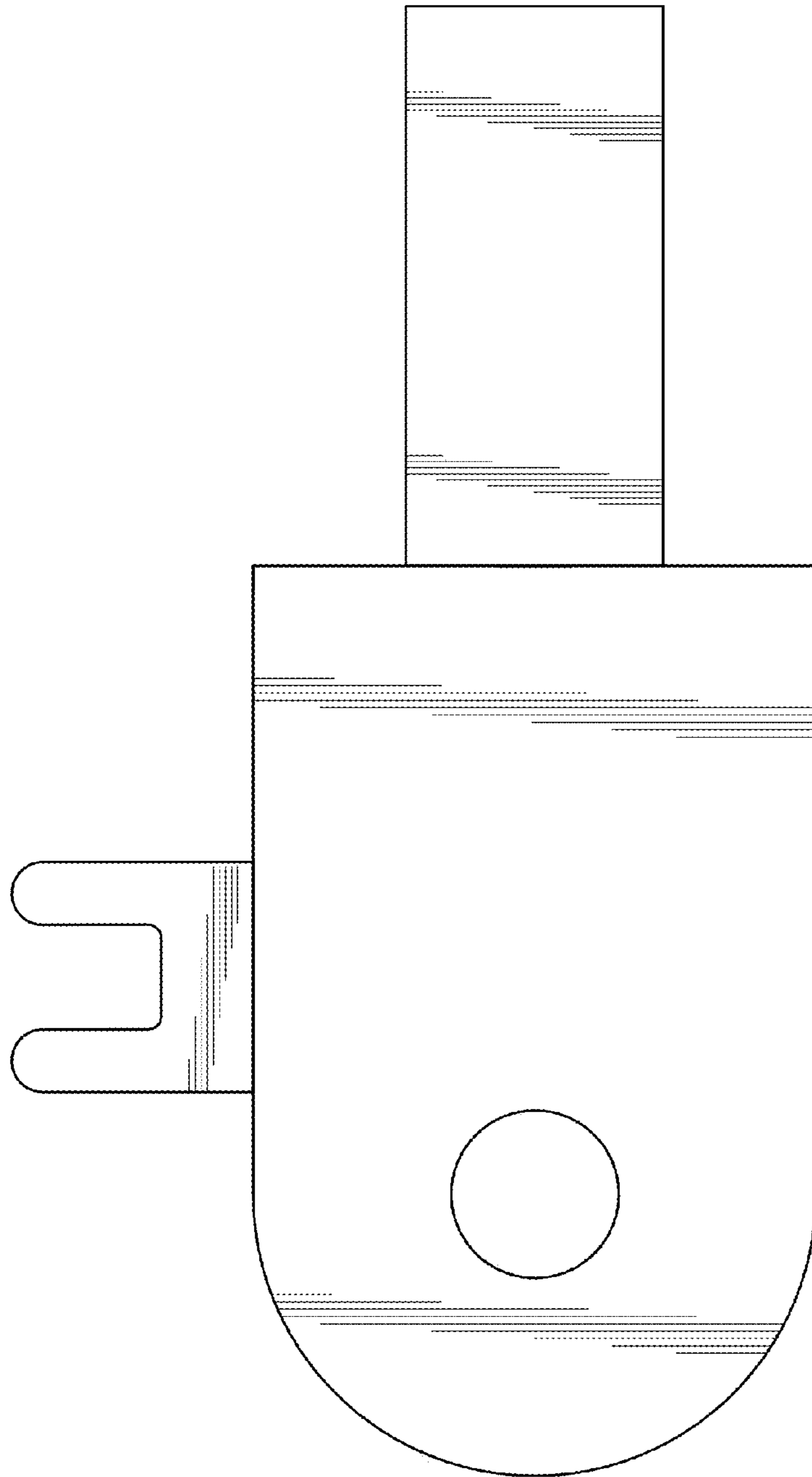

Fig. 7