



US00D706643S

(12) **United States Design Patent**
Akana et al.

(10) **Patent No.:** **US D706,643 S**
(45) **Date of Patent:** **** Jun. 10, 2014**

(54) **COMBINED EARPHONES AND PACKAGE**

(75) Inventors: **Jody Akana**, San Francisco, CA (US);
Bartley K. Andre, Palo Alto, CA (US);
Shota Aoyagi, San Francisco, CA (US);
Jeremy Bataillou, San Francisco, CA
(US); **Daniel J. Coster**, San Francisco,
CA (US); **Daniele De Iuliis**, San
Francisco, CA (US); **M. Evans Hankey**,
San Francisco, CA (US); **Julian Hoenig**,
San Francisco, CA (US); **Richard P.**
Howarth, San Francisco, CA (US);
Jonathan P. Ive, San Francisco, CA
(US); **Duncan Robert Kerr**, San
Francisco, CA (US); **Shin Nishibori**,
Kailua, HI (US); **Matthew Dean**
Rohrbach, San Francisco, CA (US);
Peter Russell-Clarke, San Francisco,
CA (US); **Mikael Silvanto**, San
Francisco, CA (US); **Christopher J.**
Stringer, Woodside, CA (US); **Eugene**
Antony Whang, San Francisco, CA
(US); **Rico Zörkendörfer**, San
Francisco, CA (US)

(73) Assignee: **Apple Inc.**, Cupertino, CA (US)

(**) Term: **14 Years**

(21) Appl. No.: **29/431,868**

(22) Filed: **Sep. 11, 2012**

(51) **LOC (10) Cl.** **09-01**

(52) **U.S. Cl.**
USPC **D9/721; D9/432**

(58) **Field of Classification Search**
USPC D9/414, 416, 418, 420–424, 430–434,
D9/455–456, 721; D3/272, 273, 294–296,
D3/302; 206/267, 269, 270, 273, 299, 737,
206/740, 822; 229/100, 101, 101.3, 106,
229/108–122; D7/601–603

See application file for complete search history.

(56) **References Cited**

U.S. PATENT DOCUMENTS

4,542,822 A 9/1985 Kennedy, Jr. et al.
D397,865 S 9/1998 Lin
5,984,224 A 11/1999 Yang
D479,016 S * 8/2003 Sgariboldi D28/78

(Continued)

OTHER PUBLICATIONS

Jacostore.co.uk, “Black Ladybird Beetle Earphones,” (<http://www.jacostore.co.uk/black-ladybird-beetle-earphones-45-p.asp>),
accessed Oct. 19, 2012, 1 page.

(Continued)

Primary Examiner — Susan Bennett Hattan

Assistant Examiner — Vy Koenig

(74) *Attorney, Agent, or Firm* — Sterne, Kessler, Goldstein
& Fox P.L.L.C.

(57) **CLAIM**

The ornamental design for combined earphones and package,
as shown and described.

DESCRIPTION

FIG. 1 is a top perspective view of combined earphones and
package showing our new design;
FIG. 2 is a top view thereof;
FIG. 3 is a bottom view thereof;
FIG. 4 is a rear view thereof;
FIG. 5 is a front view thereof;
FIG. 6 is left view thereof; and,
FIG. 7 is a right view thereof.

The broken lines in the Figures show portions of the com-
bined earphones and package that form no part of the claimed
design.

The shade lines in the Figures show contour and transparency,
and not surface ornamentation.

1 Claim, 5 Drawing Sheets

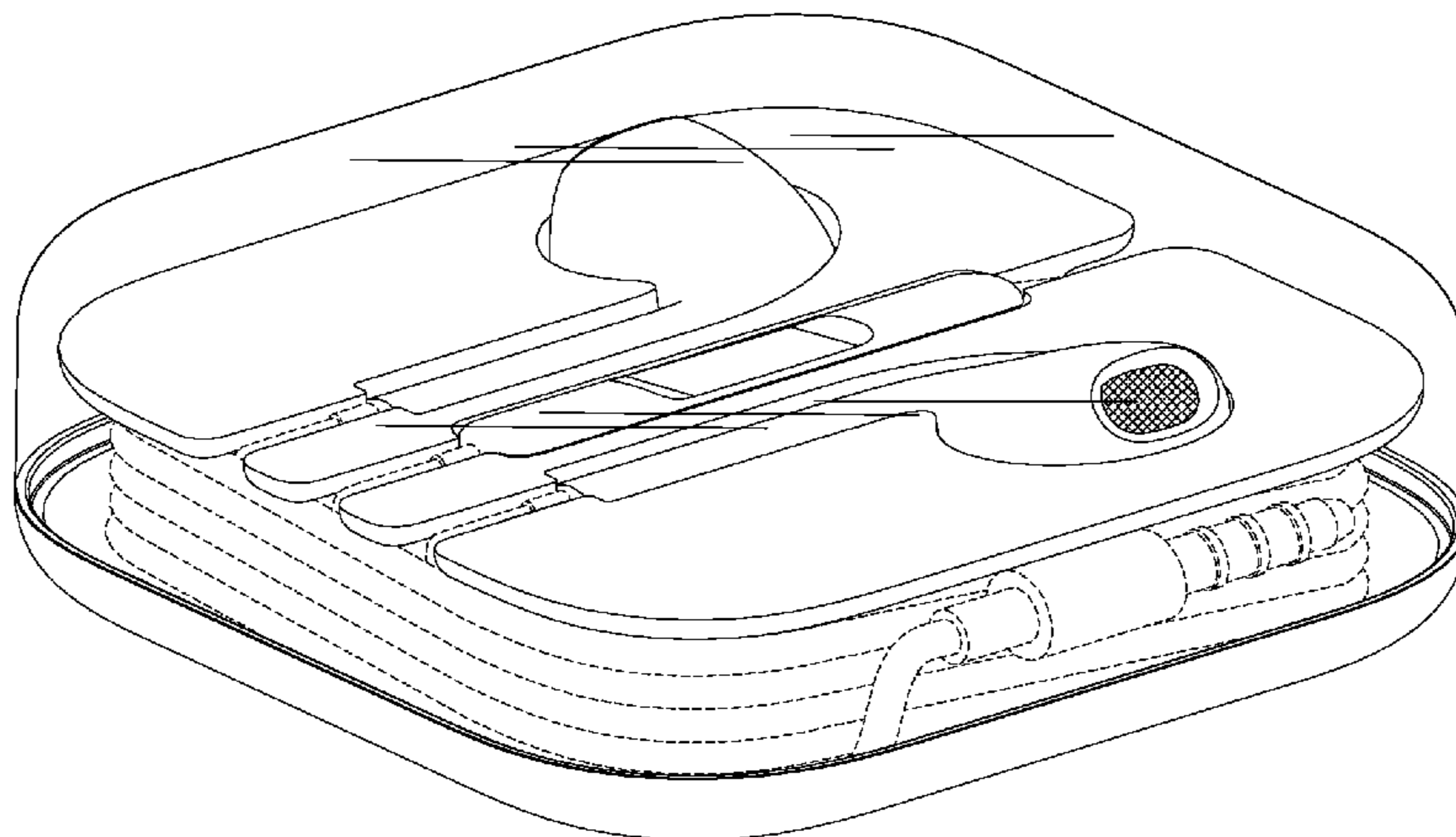

(56)

References Cited

U.S. PATENT DOCUMENTS

D493,335	S	*	7/2004	Armato	D7/629
D506,744	S		6/2005	Andre et al.		
D531,025	S		10/2006	Tanner		
D556,571	S	*	12/2007	Jalet	D9/432
D558,571	S	*	1/2008	Andre et al.	D9/432
D577,250	S	*	9/2008	Zanaletti	D7/391
D580,752	S		11/2008	Andre et al.		
D584,142	S	*	1/2009	Andre et al.	D9/432
D601,884	S		10/2009	Andre et al.		
D604,501	S		11/2009	Lee		
D604,605	S	*	11/2009	Chung et al.	D9/432
D616,741	S	*	6/2010	Andre et al.	D9/432
D618,999	S	*	7/2010	Akana et al.	D9/430
D620,984	S	*	8/2010	Rose et al.	D20/27
D621,256	S		8/2010	Andre et al.		
D624,316	S	*	9/2010	Ferber et al.	D3/294
D637,076	S	*	5/2011	Akana et al.	D9/430
D649,449	S		11/2011	Akana et al.		
D658,492	S		5/2012	Akana et al.		
D659,530	S		5/2012	Akana et al.		
D668,143	S		10/2012	Akana et al.		
D672,660	S	*	12/2012	Vural	D9/721
D676,321	S	*	2/2013	Jones et al.	D9/456
D685,771	S	*	7/2013	Bertenthal	D14/223
D686,065	S	*	7/2013	Kuo et al.	D9/432

OTHER PUBLICATIONS

Akana et al., U.S. Appl. No. 29/431,563, "Earphones," filed Sep. 8, 2012 (Not Published).
 Akana et al., U.S. Appl. No. 29/431,731, "Stand," filed Sep. 11, 2012 (Not Published).
 Akana et al., U.S. Appl. No. 29/431,876, "Packaging with Accessory," filed Sep. 11, 2012 (Not Published).
 Akana et al., U.S. Appl. No. 29/431,877, "Packaging with Accessories," filed Sep. 12, 2012 (Not Published).
 Akana et al., U.S. Appl. No. 29/431,882, "Packaging with Accessories," filed Sep. 12, 2012 (Not Published).
 Akana et al., U.S. Appl. No. 29/431,920, "Packaging with Accessories," filed Sep. 12, 2012 (Not Published).
 Akana et al., U.S. Appl. No. 29/432,033, "Earphones," filed Sep. 12, 2012 (Not Published).
 Akana et al., U.S. Appl. No. 29/432,035, "Packaging with Accessories," filed Sep. 12, 2012 (Not Published).
 Akana et al., U.S. Appl. No. 29/432,147, "Packaging with Accessories," filed Sep. 13, 2012 (Not Published).
 Akana et al., U.S. Appl. No. 29/432,409, "Packaging with Accessories," filed Sep. 14, 2012 (Not Published).

* cited by examiner

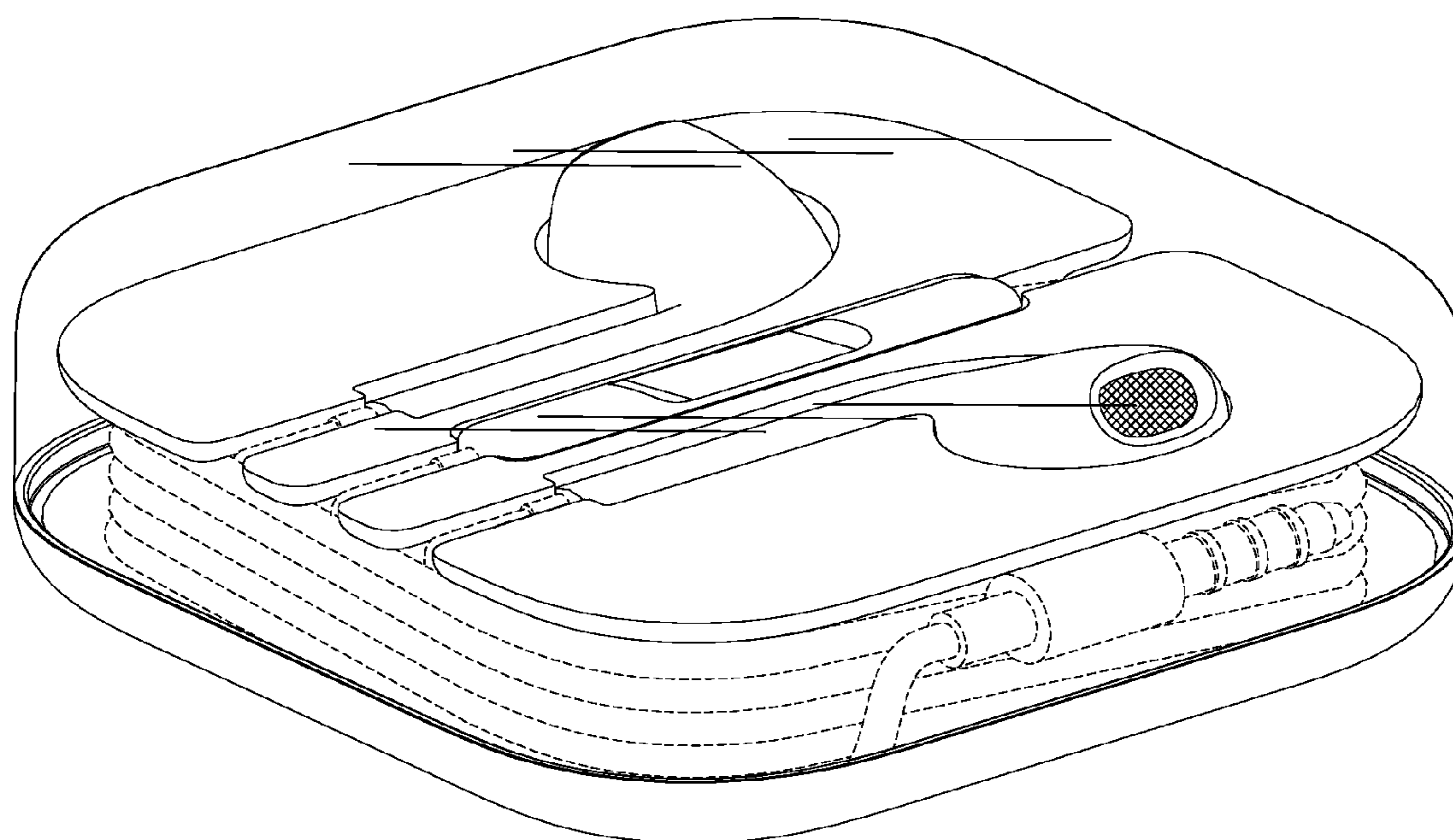

FIG. 1

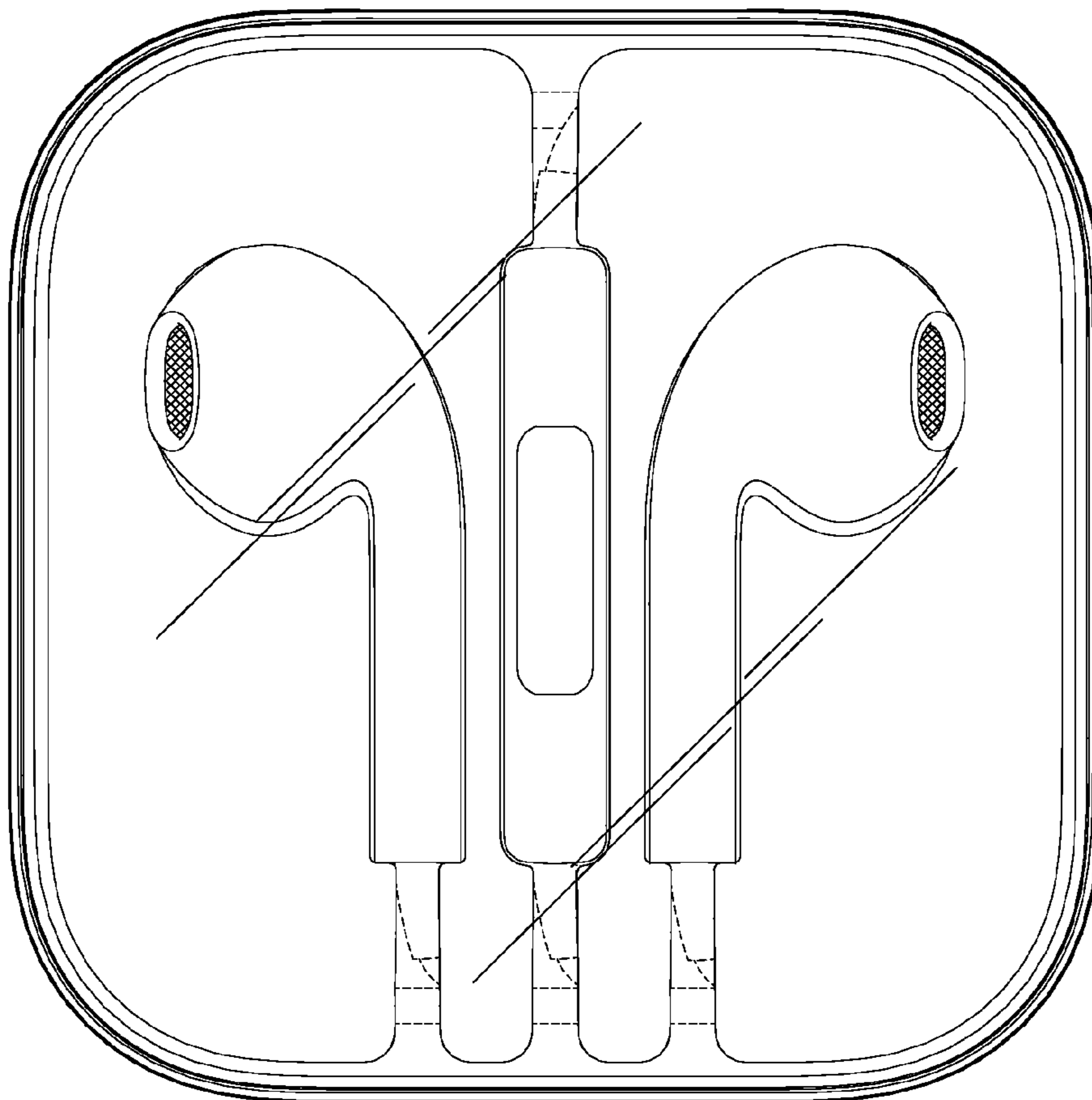

FIG. 2

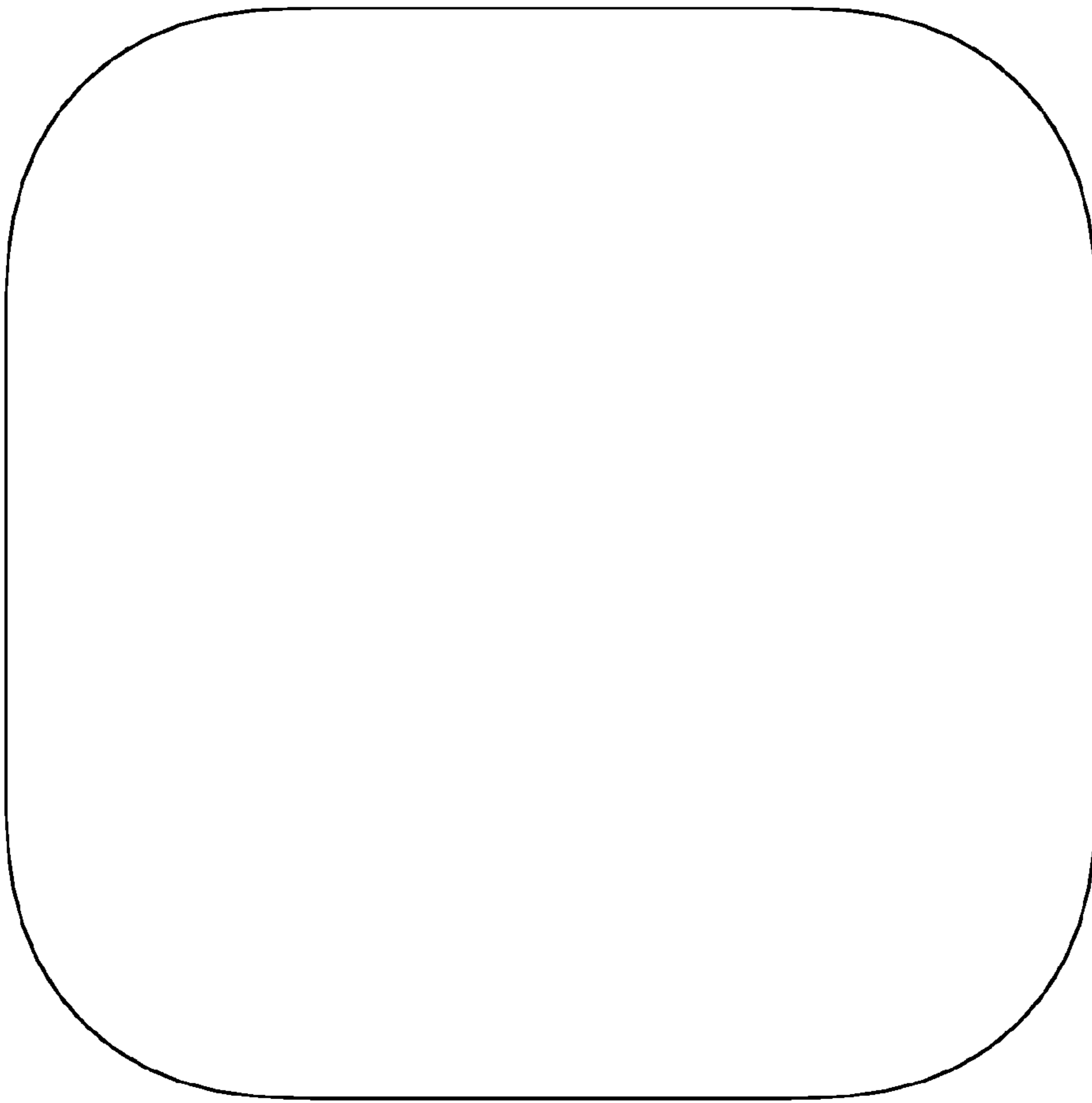

FIG. 3

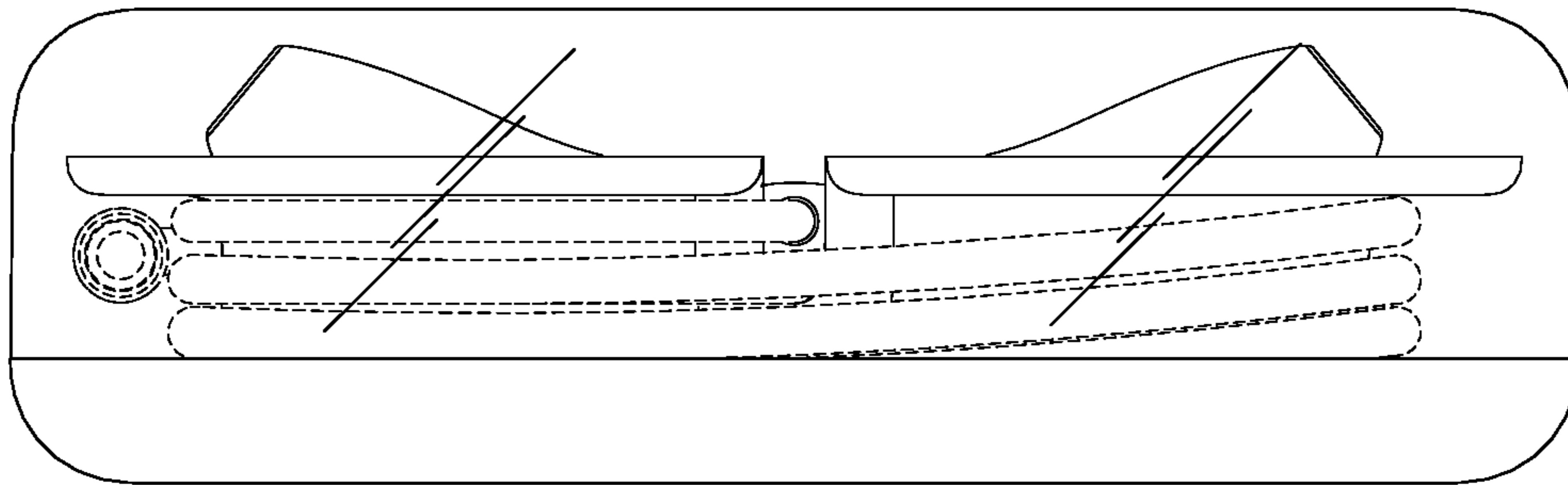

FIG. 4

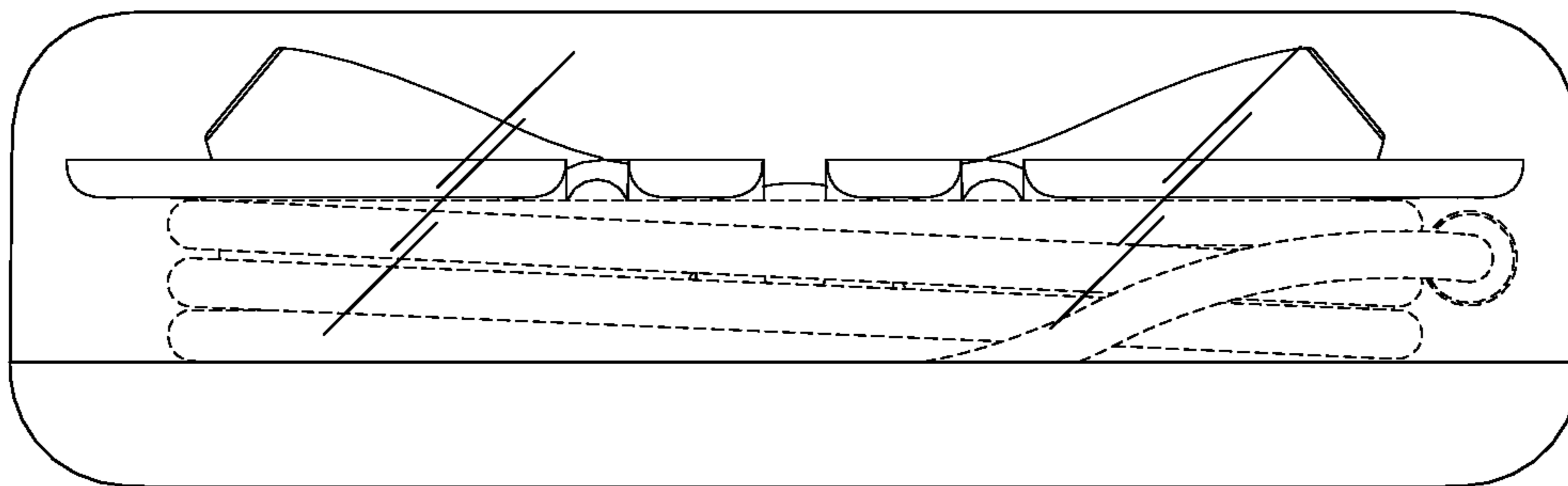

FIG. 5

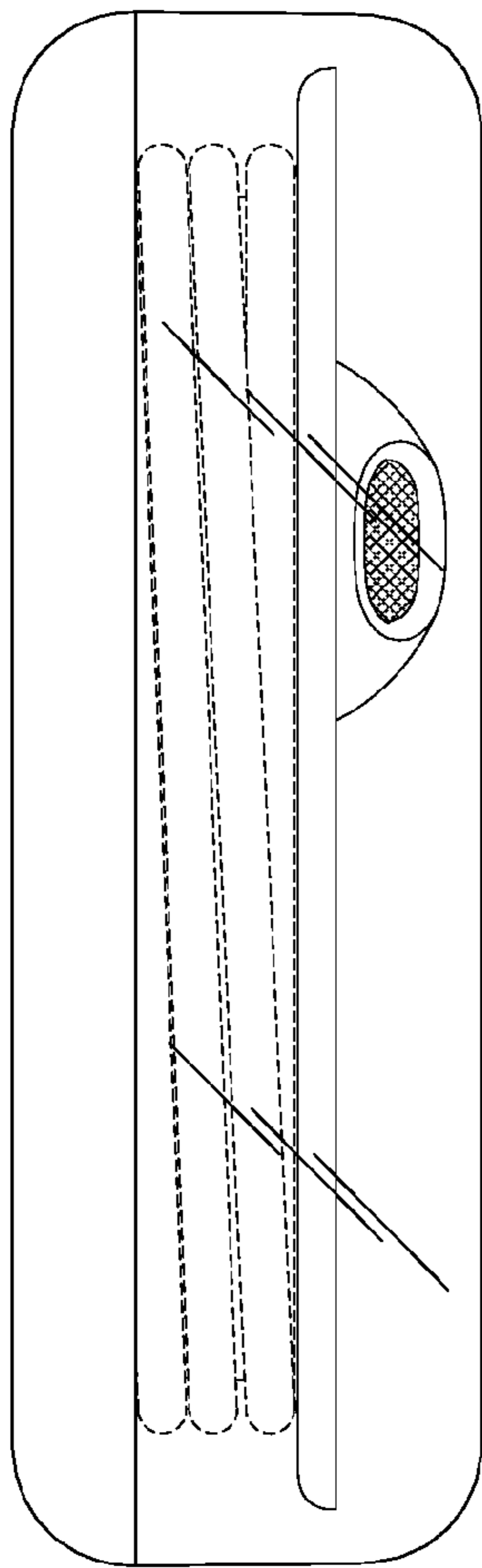

FIG. 6

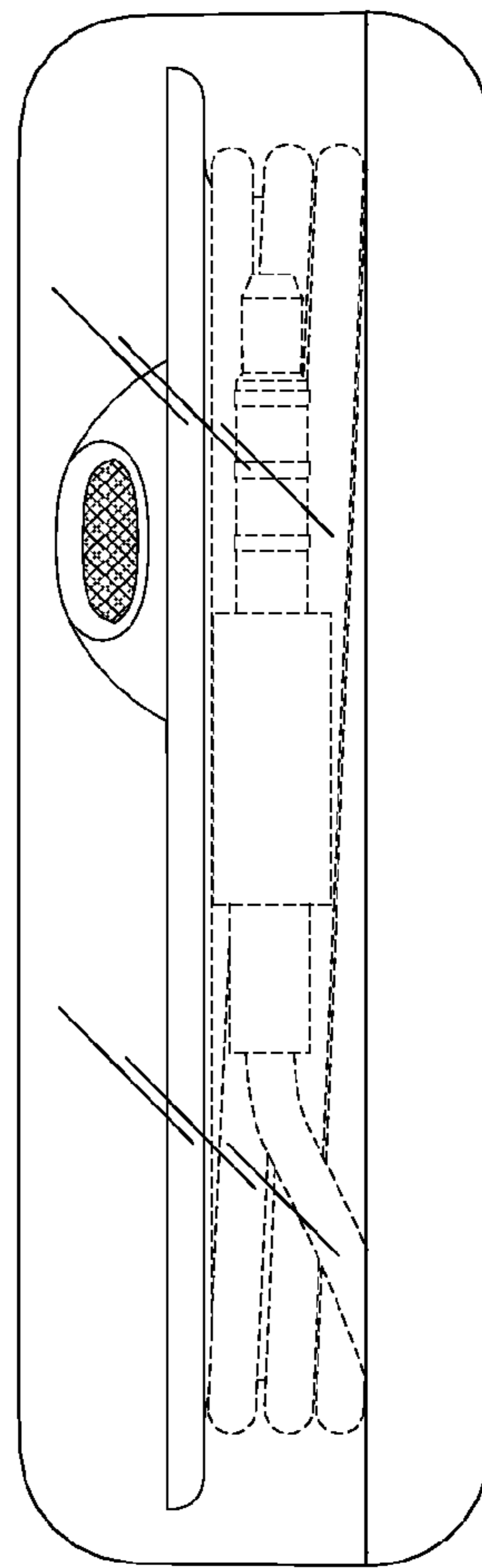

FIG. 7