



US00D706620S

(12) **United States Design Patent**  
**Matsumura et al.**

(10) **Patent No.:** **US D706,620 S**  
(45) **Date of Patent:** **\*\* Jun. 10, 2014**

(54) **TRAY**

(56) **References Cited**

- (71) Applicant: **The Procter & Gamble Company**, Cincinnati, OH (US)
- (72) Inventors: **Satoshi Matsumura**, Singapore (SG); **Wolfram Beck**, Singapore (SG); **Ferdinand Casipe Calantoc**, Beijing (CN); **Anirban Mukherjee**, Singapore (SG); **Lifang Niu**, Singapore (SG); **Rahul Pise**, Singapore (SG); **Muthuraja Subbiah**, Singapore (SG)
- (73) Assignee: **The Procter & Gamble Company**, Cincinnati, OH (US)
- (\*\*) Term: **14 Years**
- (21) Appl. No.: **29/464,545**
- (22) Filed: **Aug. 19, 2013**
- (51) **LOC (10) Cl.** ..... **09-03**
- (52) **U.S. Cl.**  
USPC ..... **D9/424; D9/432**
- (58) **Field of Classification Search**  
CPC ..... B29L 2031/7162; B29L 2031/7164; B29L 2031/7165; B65D 1/22; B65D 1/225; B65D 1/34; B65D 43/162; B65D 81/02; B65D 81/3813; B65D 5/001; B65D 5/0025; B65D 5/64; B65D 21/00; B65D 2501/24; B65D 2501/24019; B65D 2207/00  
USPC ..... D9/415-419, 420-425, 428, 429-435, D9/708, 719, 734; D3/203.2, 272, 273, D3/294, 302-304; D7/538-542, 601, 602, D7/629; 220/780-806, 574-575; 206/521.1, 541, 564
- See application file for complete search history.

U.S. PATENT DOCUMENTS

D305,618 S *	1/1990	Blaser .....	D9/425
D363,662 S *	10/1995	Plater .....	D9/425
D510,263 S *	10/2005	Isono et al. ....	D9/425
D536,608 S *	2/2007	Arkins .....	D9/414
D618,954 S *	7/2010	Antoun et al. ....	D7/354
D618,955 S *	7/2010	Antoun et al. ....	D7/354
D630,045 S *	1/2011	Antoun et al. ....	D7/392.1
D632,956 S *	2/2011	Fuller et al. ....	D9/424
D690,553 S *	10/2013	Tosdale et al. ....	D7/354
D691,845 S *	10/2013	Tosdale et al. ....	D7/354
D696,937 S *	1/2014	Prater et al. ....	D9/425
D698,643 S *	2/2014	Malley et al. ....	D9/425

\* cited by examiner

*Primary Examiner* — Susan Bennett Hattan

*Assistant Examiner* — Vy Koenig

(74) *Attorney, Agent, or Firm* — Amy I Ahn-Roll

(57) **CLAIM**

The ornamental design for tray, as shown and described.

**DESCRIPTION**

FIG. 1 is a top perspective view of tray, embodying our new design;

FIG. 2 is a right view thereof;

FIG. 3 is a left view thereof;

FIG. 4 is a back view thereof;

FIG. 5 is a front view thereof;

FIG. 6 is a top view thereof;

FIG. 7 is a bottom view thereof; and,

FIG. 8 is a bottom perspective view thereof.

**1 Claim, 6 Drawing Sheets**

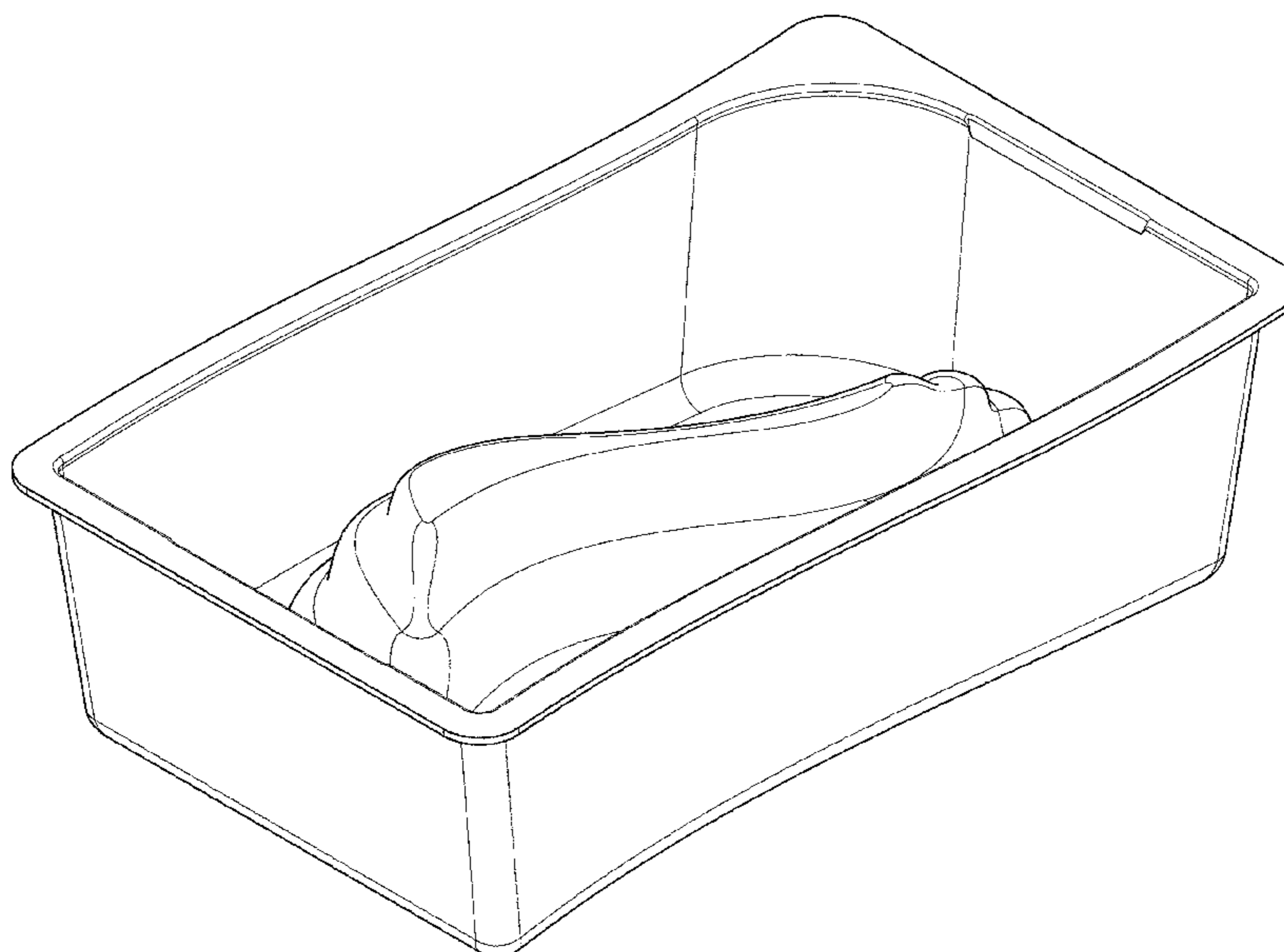

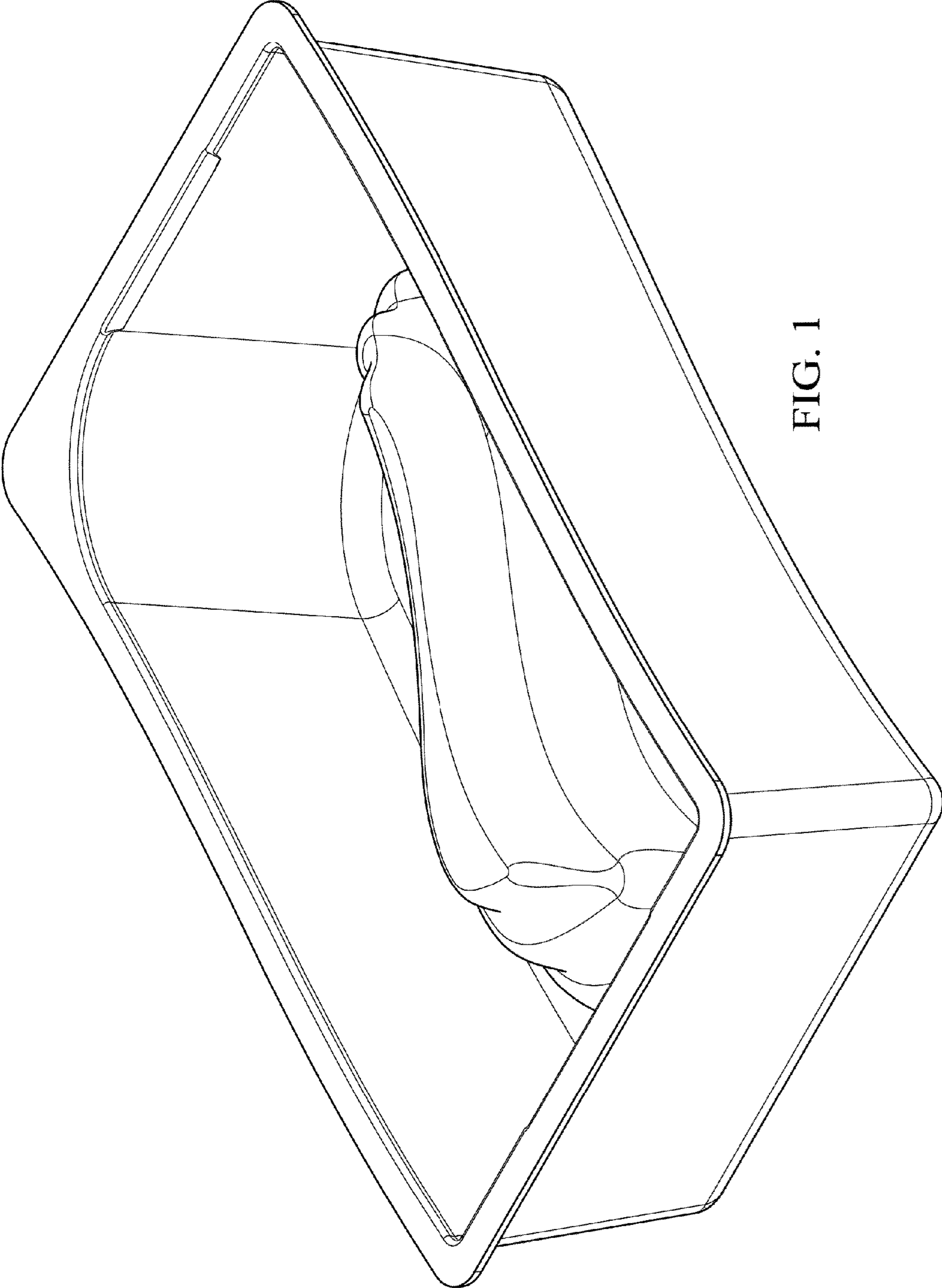

FIG. 1

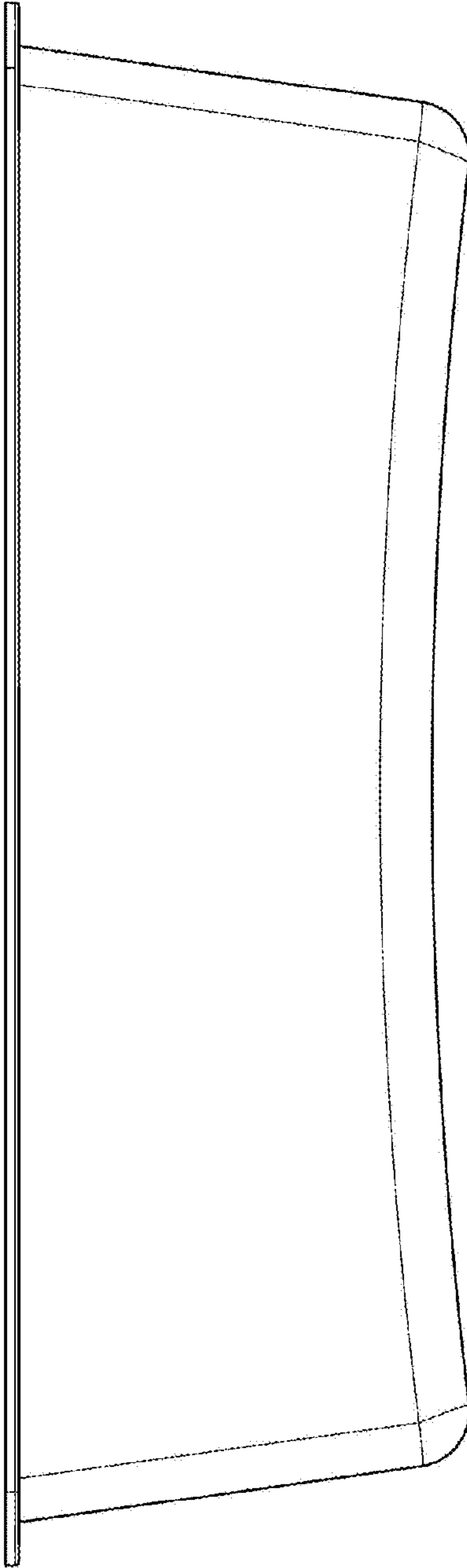

FIG. 2

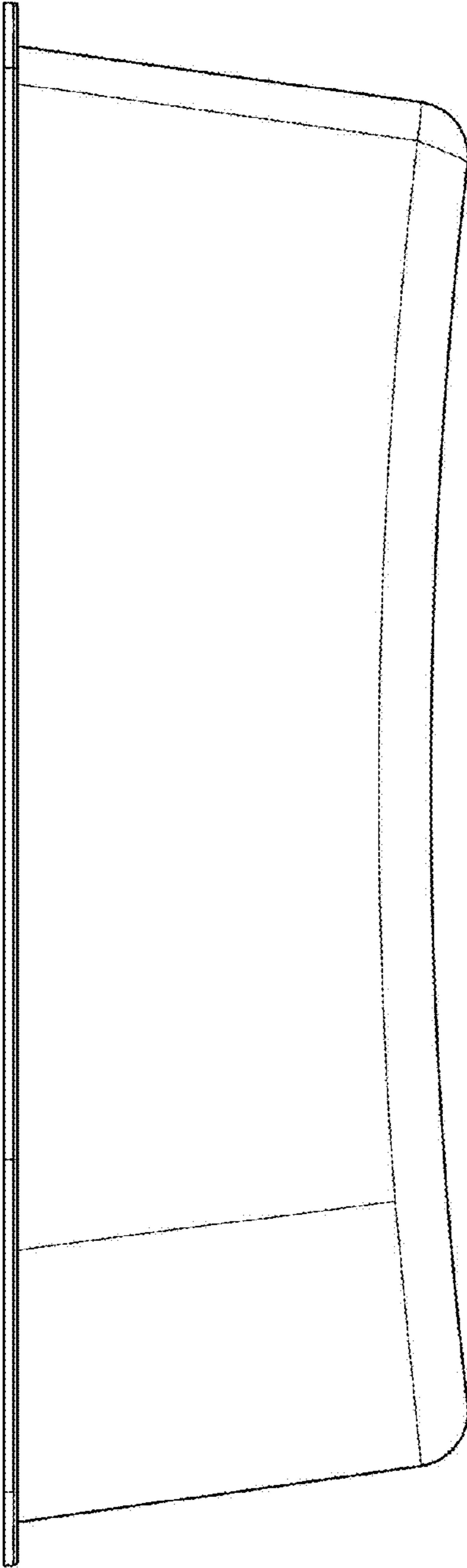

FIG. 3

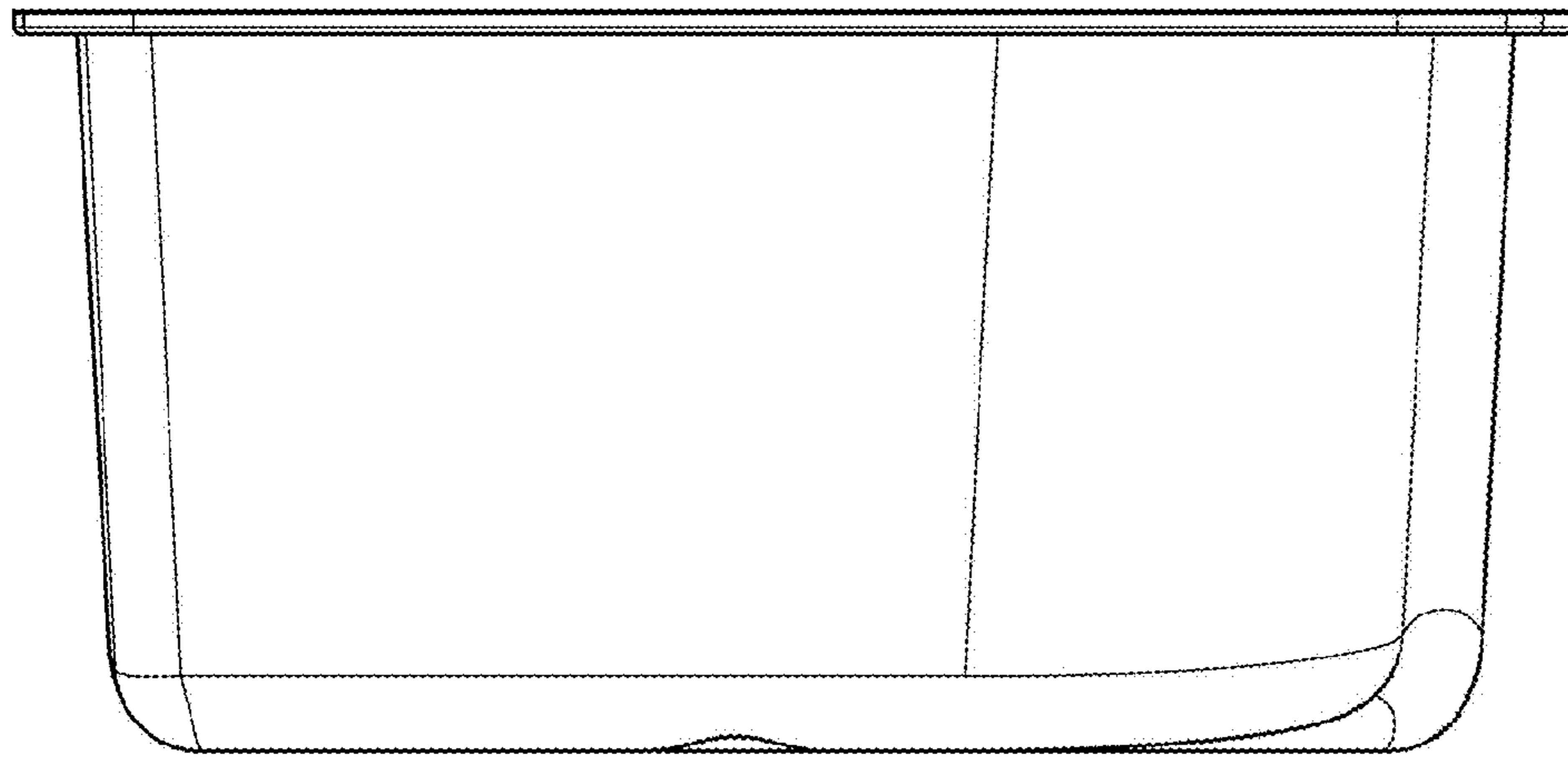

FIG. 4

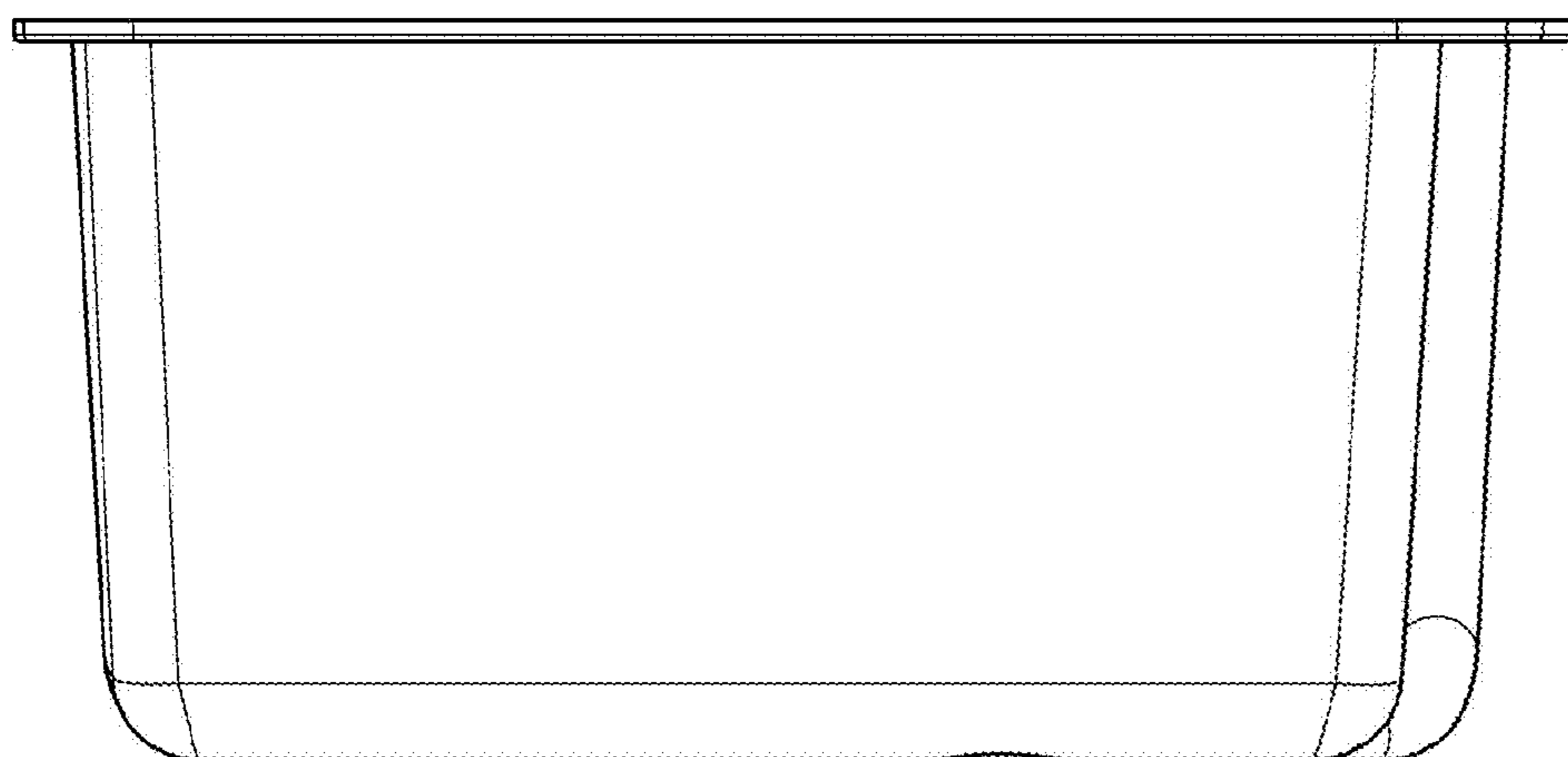

FIG. 5

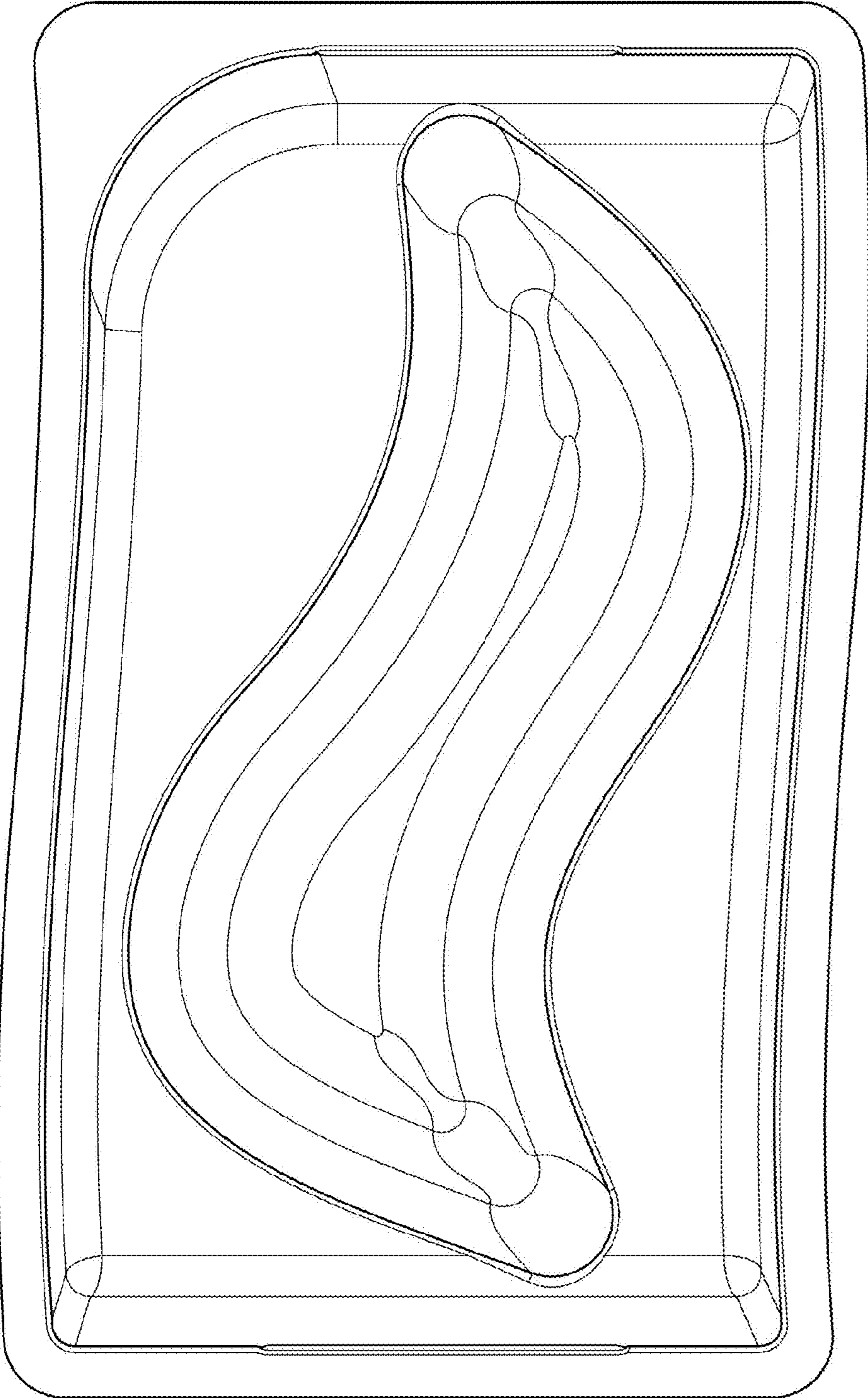

FIG. 6

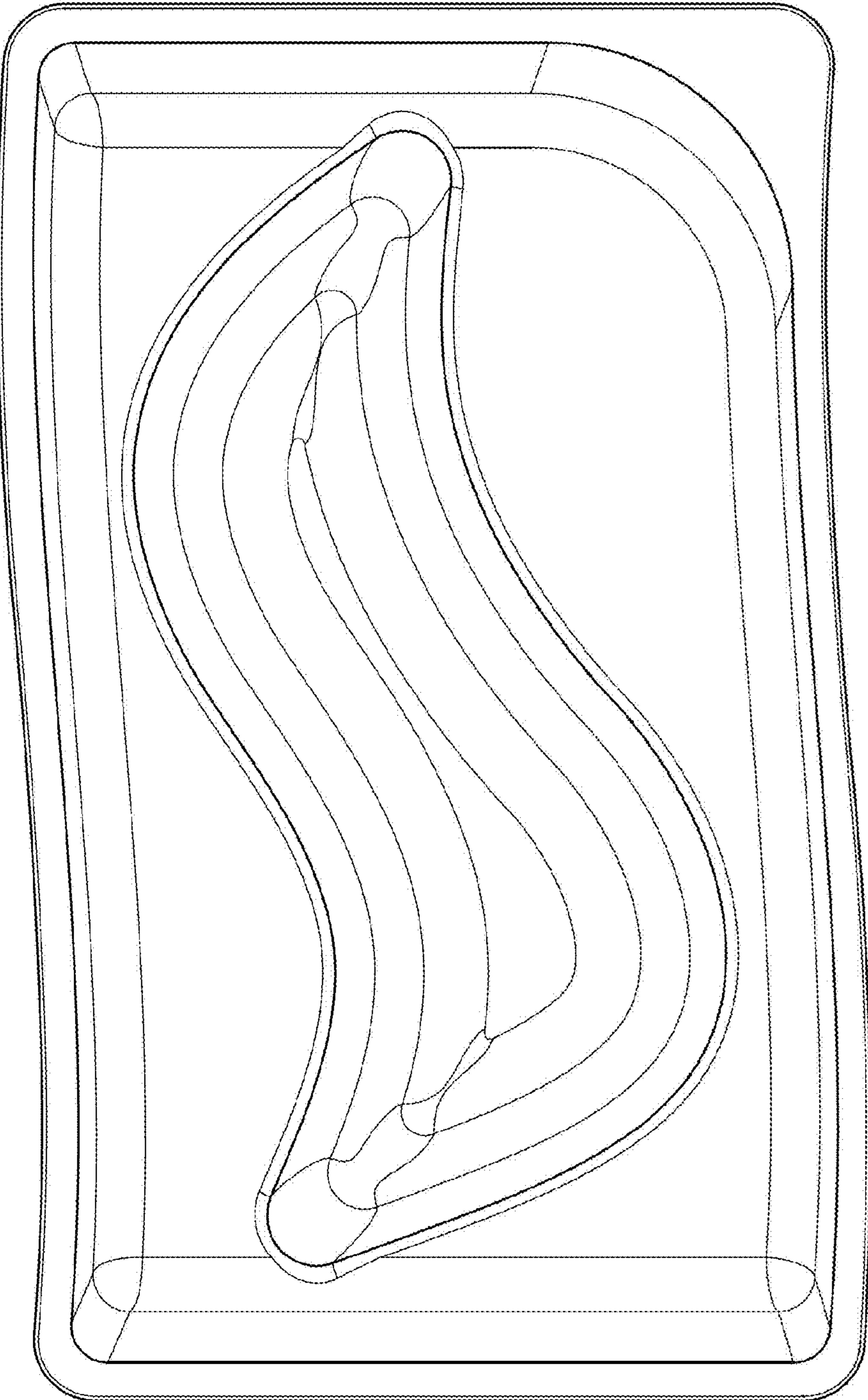

FIG. 7

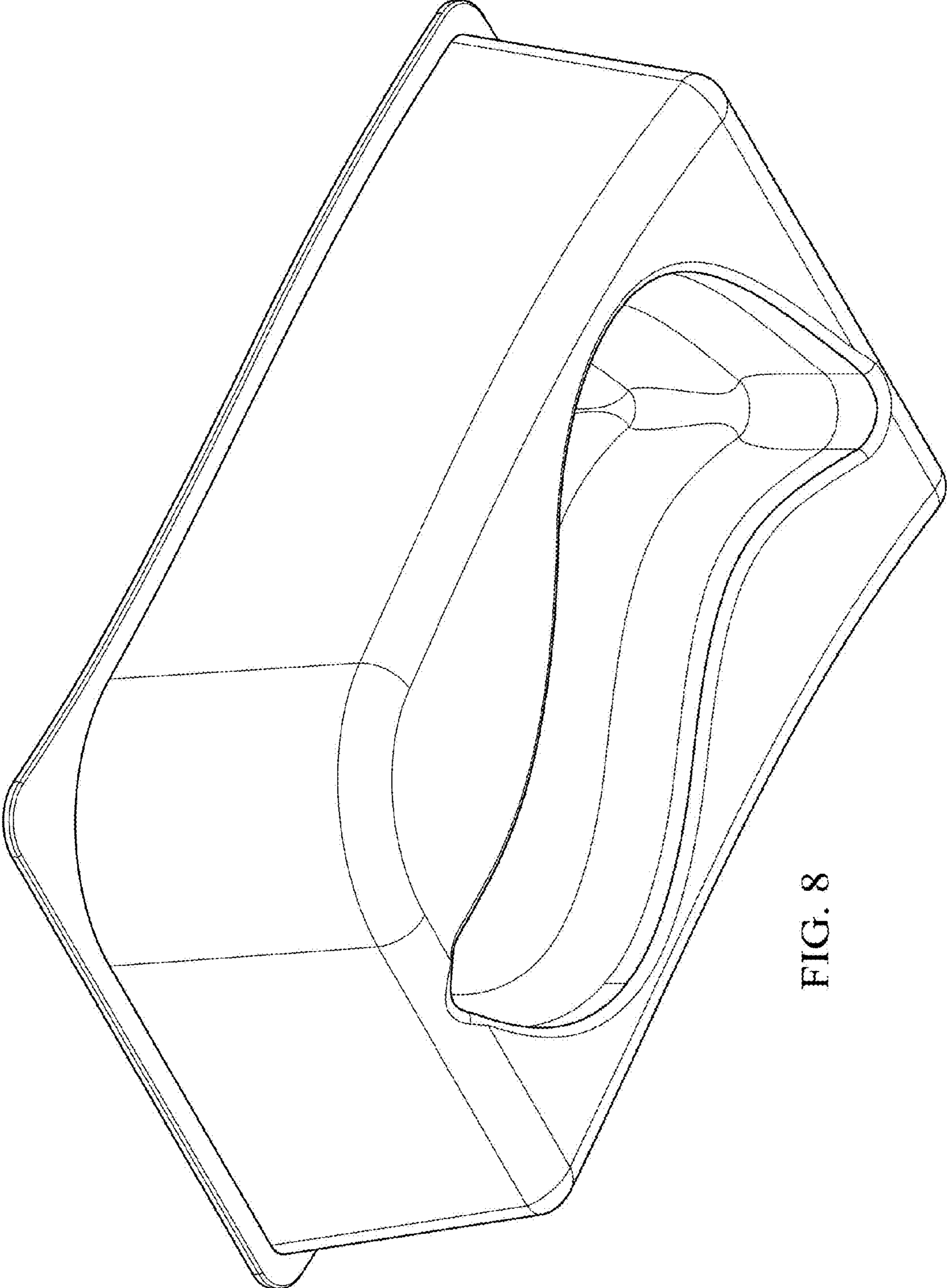

FIG. 8