



US00D706586S

(12) **United States Design Patent**  
**Kestenbaum**

(10) **Patent No.:** **US D706,586 S**

(45) **Date of Patent:** **\*\* Jun. 10, 2014**

(54) **SALAD SERVER**

(71) Applicant: **DKB Household UK Limited**,  
Farnborough (GB)

(72) Inventor: **Dan Kestenbaum**, Guildford (GB)

(73) Assignee: **DKB Household UK Limited**,  
Hampshire (GB)

(\*\*) Term: **14 Years**

(21) Appl. No.: **29/452,831**

(22) Filed: **Apr. 22, 2013**

(30) **Foreign Application Priority Data**

Oct. 23, 2012 (EM) ..... 002123588-0004

(51) **LOC (10) Cl.** ..... **07-06**

(52) **U.S. Cl.**  
USPC ..... **D7/688**

(58) **Field of Classification Search**  
USPC ..... D7/680-696, 368, 669, 653, 643, 645,  
D7/642; 30/322-328; 294/7, 8, 55.5, 49,  
294/176; 7/110, 113

See application file for complete search history.

(56) **References Cited**

U.S. PATENT DOCUMENTS

5,699,618 A \* 12/1997 Barbera ..... 30/322  
D618,070 S \* 6/2010 Jalet et al. .... D7/691  
D648,602 S \* 11/2011 Gray ..... D7/688

\* cited by examiner

*Primary Examiner* — Terry Wallace

(74) *Attorney, Agent, or Firm* — Kaplan Breyer Schwarz &  
Ottesen, LLP

(57) **CLAIM**

The ornamental design for a salad server, as shown and described.

**DESCRIPTION**

FIG. 1 is a top, rear and left side perspective view of the salad server comprising a salad server spoon and a salad server fork positioned on top of the salad server spoon;

FIG. 2 is a top view thereof;

FIG. 3 is a bottom view thereof;

FIG. 4 is a left side view thereof;

FIG. 5 is a right side view thereof;

FIG. 6 is a rear view thereof; and,

FIG. 7 is a front view thereof.

The broken lines shown in the drawing views are included for illustrative purposes only and are not intended to limit the claimed design.

**1 Claim, 5 Drawing Sheets**

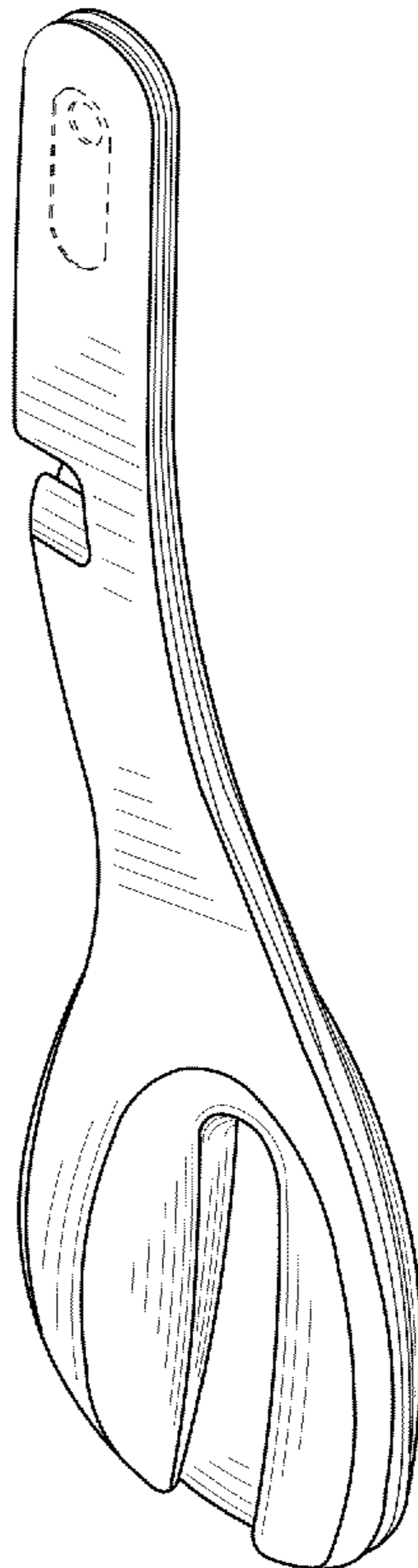

Figure 1

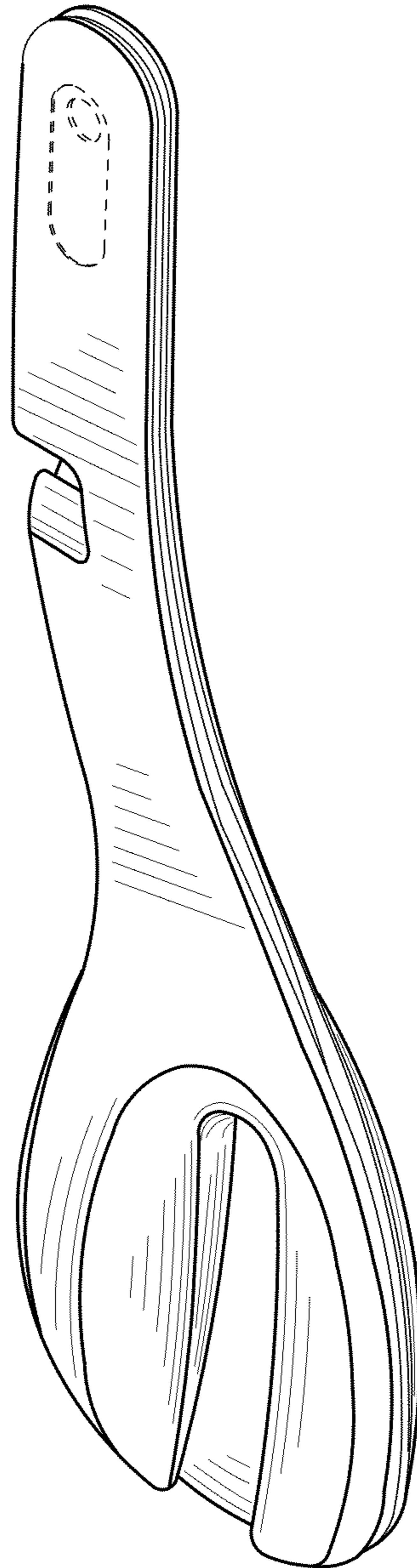

Figure 2

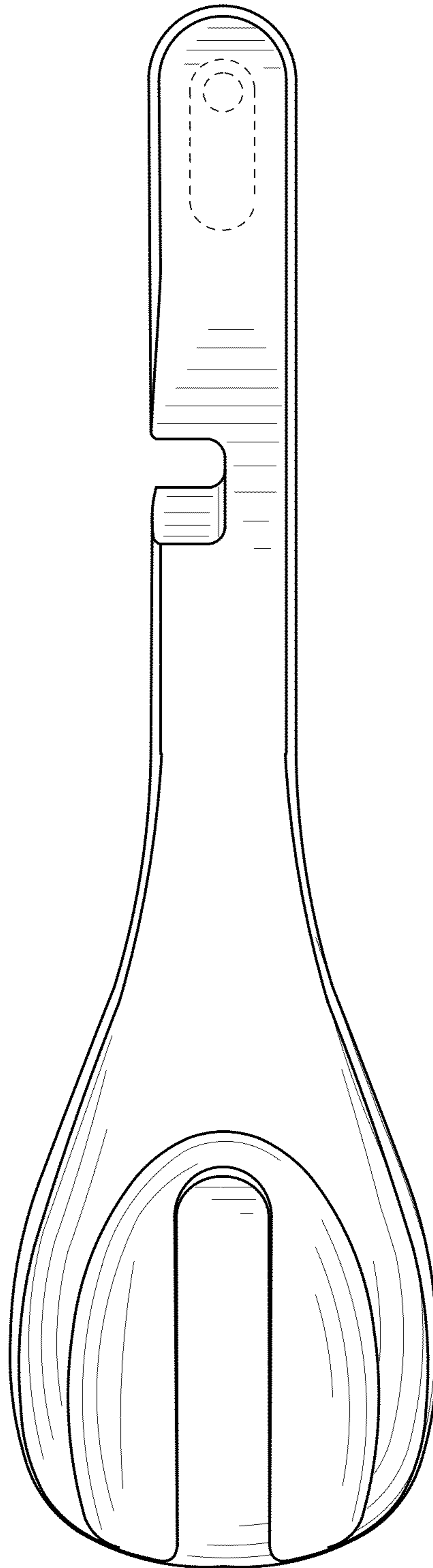

Figure 3

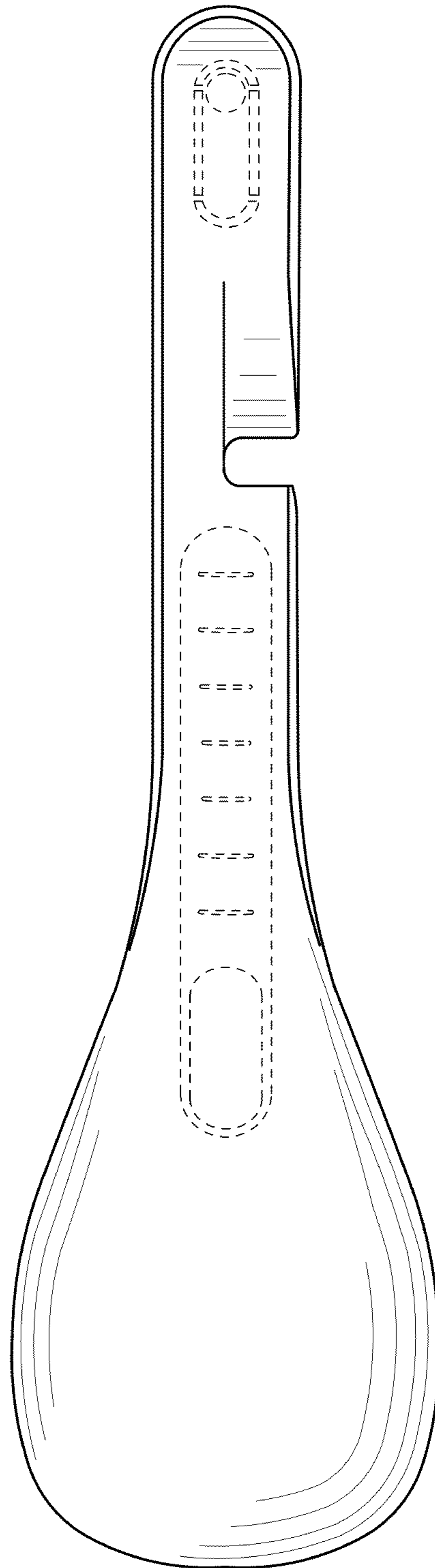

Figure 4

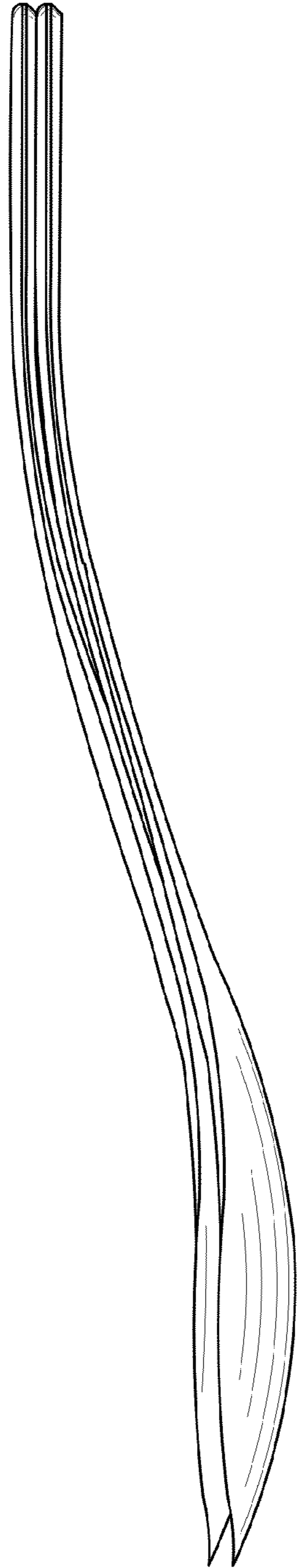

Figure 5

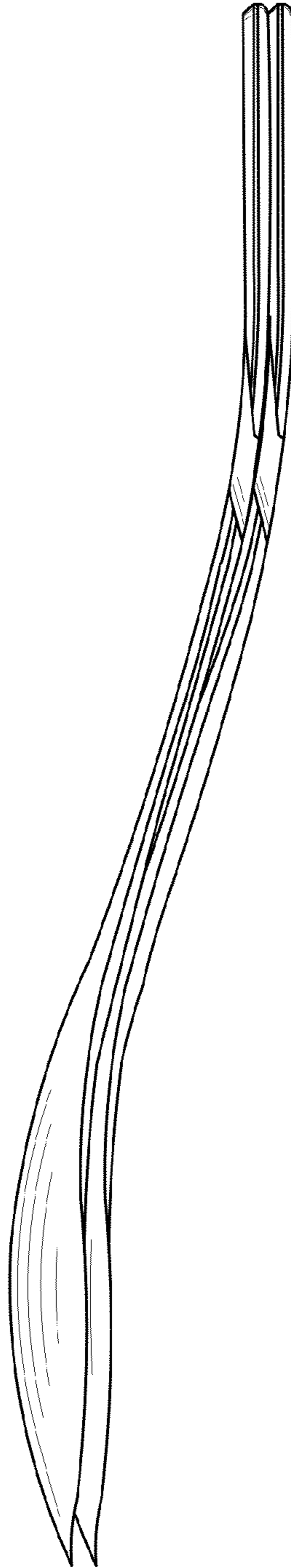

Figure 6

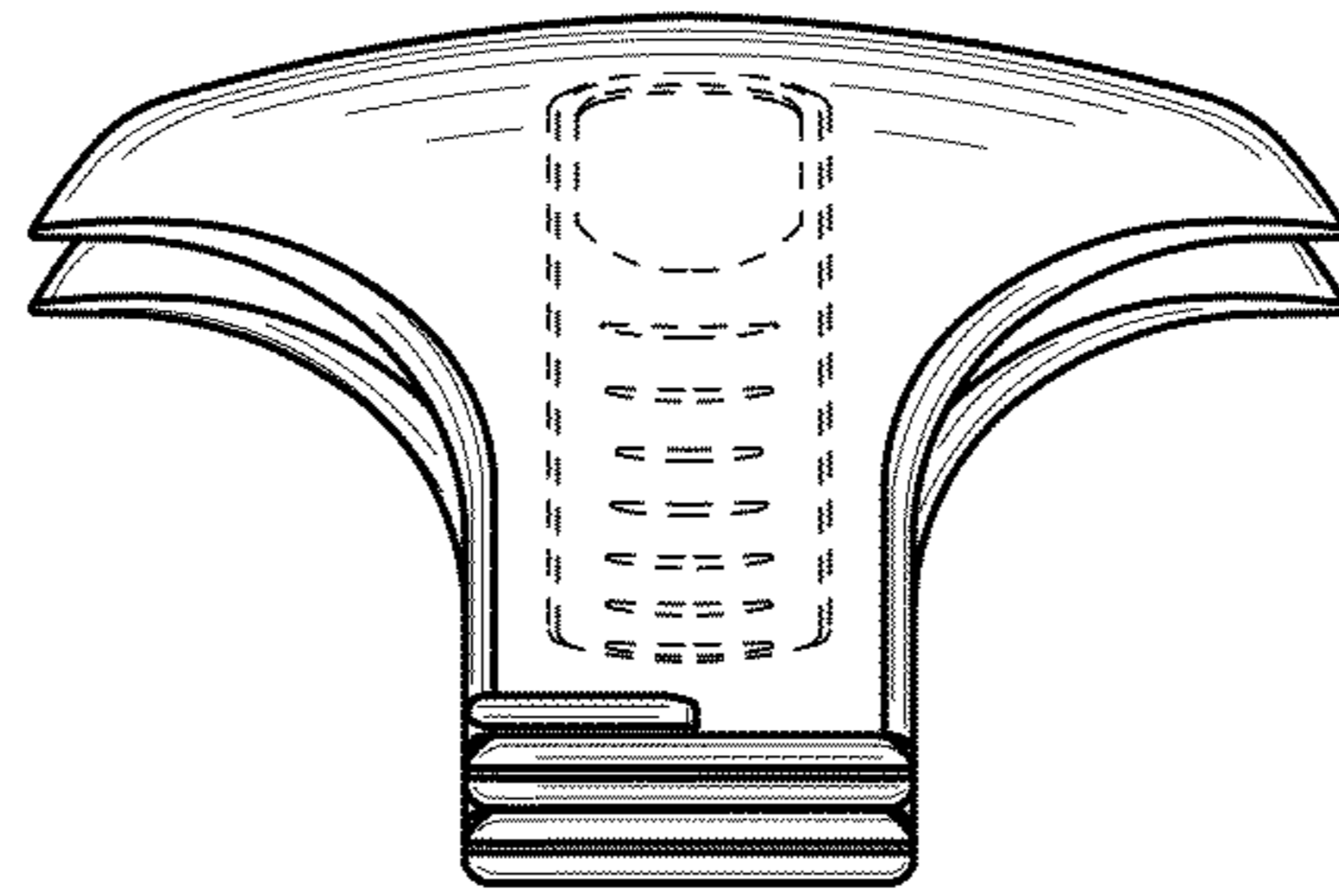

Figure 7

