



US00D706581S

(12) **United States Design Patent**
Pendleton et al.

(10) **Patent No.:** **US D706,581 S**
(45) **Date of Patent:** **** Jun. 10, 2014**

(54) **TOOL FOR ELECTRIC MIXER**

4,173,310 A * 11/1979 Schaeffer 241/282.1
4,260,267 A * 4/1981 Walton 366/343
4,331,300 A * 5/1982 Hicks et al. 241/282.1

(71) Applicant: **Kenwood Limited**, Havant (GB)

(Continued)

(72) Inventors: **Oliver Pendleton**, Havant (GB); **Martin Johns**, Havant (GB)

Primary Examiner — Ricky Pham

(73) Assignee: **Kenwood Limited**, Hampshire (GB)

(74) *Attorney, Agent, or Firm* — Fleit Gibbons Gutman Bognini Bianco PL; Martin Fleit; Paul D. Bianco

(**) Term: **14 Years**

(57) **CLAIM**

The ornamental design for a tool for electric mixer, as shown and described.

(21) Appl. No.: **29/464,729**

(22) Filed: **Aug. 20, 2013**

DESCRIPTION

(30) **Foreign Application Priority Data**

Feb. 21, 2013 (EM) 002188573-0001
Feb. 21, 2013 (EM) 002188573-0002

FIG. 1 is a perspective view from above of a first embodiment of a tool for electric mixer according to the present invention.

FIG. 2 is a first side view of the tool of FIG. 1.

FIG. 3 is a second side (opposite the first side) view of the tool of FIG. 1.

(51) **LOC (10) Cl.** **31-00**

(52) **U.S. Cl.**
USPC **D7/412**; D7/376; D7/378; D7/383;
D7/384

FIG. 4 is a third side (orthogonal to the first and second sides) view of the tool of FIG. 1.

FIG. 5 is a fourth side (opposite the third side) view of the tool of FIG. 1.

(58) **Field of Classification Search**

USPC D7/301–313, 316–326, 356–357,
D7/372–386, 391–398, 412–415, 665,
D7/691–693; D15/29, 147; D23/200;
30/265; 99/348, 508–512; 215/307;
220/563; 241/36, 101.2, 199.12,
241/282.1–282.2, 291, 292.1;
366/192–211, 241–254, 282.2, 270,
366/330.3, 434; 416/75–77, 70 R, 227 R;
473/591

FIG. 6 is a perspective view from below of the tool of FIG. 1.

FIG. 7 is a top view of the tool of FIG. 1.

FIG. 8 is a perspective view from above of a second embodiment of a tool for electric mixer according to the present invention.

FIG. 9 is a first side view of the tool of FIG. 8.

FIG. 10 is a second side (opposite the first side) view of the tool of FIG. 8.

See application file for complete search history.

FIG. 11 is a third side (orthogonal to the first and second sides) view of the tool of FIG. 8.

FIG. 12 is a fourth side (opposite the third side) view of the tool of FIG. 8.

(56) **References Cited**

U.S. PATENT DOCUMENTS

2,584,260 A * 2/1952 Custer 473/591
3,461,933 A * 8/1969 Mantelet 241/199.12

FIG. 13 is a perspective view from below of the tool of FIG. 8; and,

FIG. 14 is a top view of the tool of FIG. 8.

1 Claim, 14 Drawing Sheets

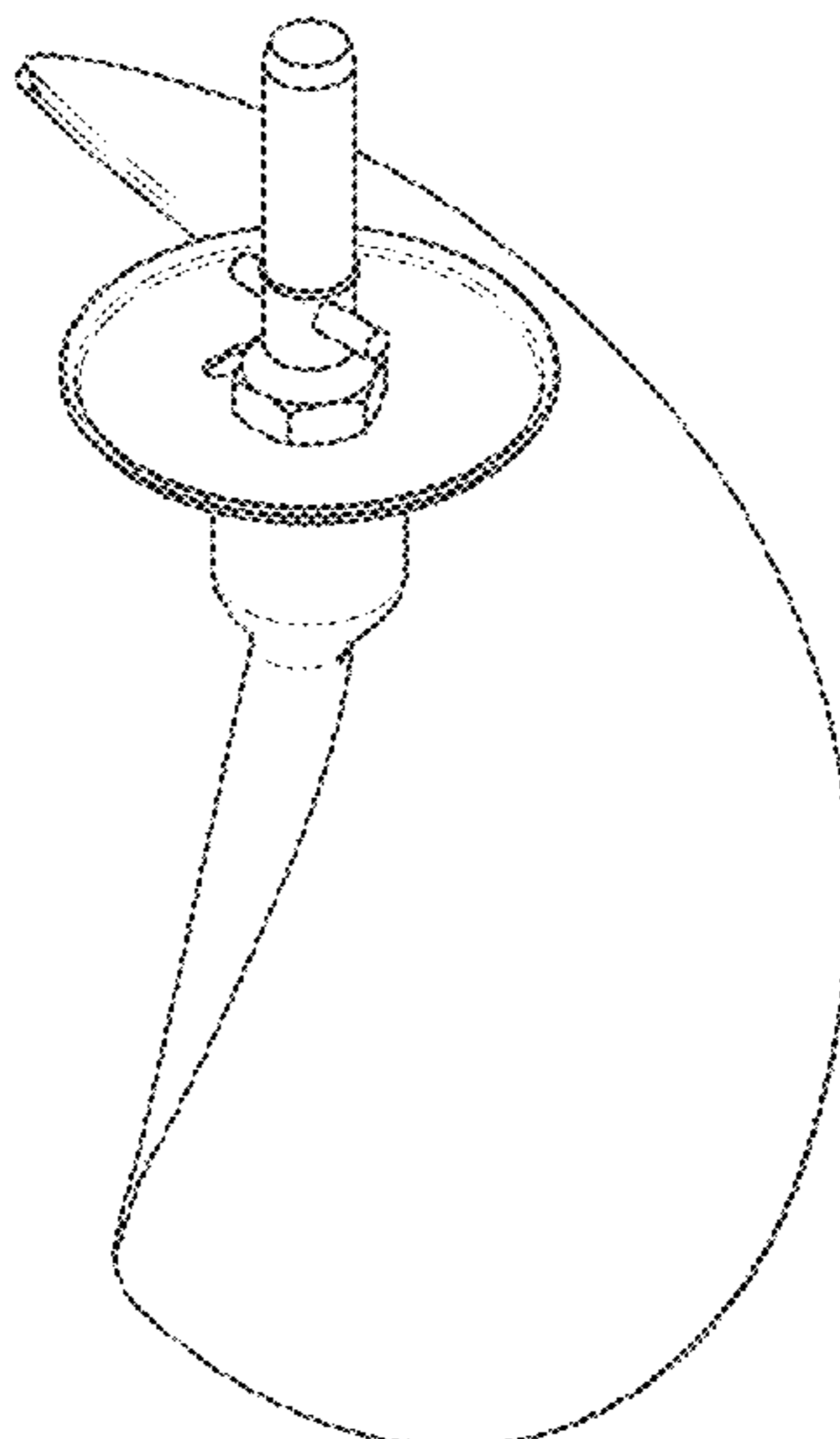

(56)

References Cited

U.S. PATENT DOCUMENTS

4,733,827 A * 3/1988 Williams 241/101.2
 4,817,878 A * 4/1989 Shibata 241/282.2
 D421,201 S * 2/2000 Crescenzi et al. D7/412
 D421,546 S * 3/2000 Ekstrom D7/412
 D432,621 S * 10/2000 Etschel et al. D23/200
 6,532,863 B1 * 3/2003 Lee 99/348
 D499,303 S * 12/2004 Huang D7/412
 D501,628 S * 2/2005 Feil D7/412
 6,866,414 B2 * 3/2005 Kupidowski 366/330.3
 D519,526 S * 4/2006 Bowsher D15/29
 D523,028 S * 6/2006 Fitzpatrick D15/29
 D572,076 S * 7/2008 Ling D7/384
 7,419,111 B2 * 9/2008 Gursel 241/282.1
 D604,101 S * 11/2009 Sands D7/412
 7,641,380 B2 * 1/2010 Behar et al. 366/205
 D622,095 S * 8/2010 Metaxatos et al. D7/383

D624,359 S * 9/2010 Schleinzer D7/412
 D647,364 S * 10/2011 Audette et al. D7/412
 D647,365 S * 10/2011 Audette et al. D7/412
 8,132,752 B1 * 3/2012 Hotaling et al. 241/282.1
 D663,586 S * 7/2012 Audette D7/412
 D668,115 S * 10/2012 Potter D7/412
 D682,030 S * 5/2013 Ezechukwu D7/412
 D684,817 S * 6/2013 Leavitt D7/412
 D690,751 S * 10/2013 Kehoe et al. D15/147
 D696,070 S * 12/2013 Audette D7/412
 D700,013 S * 2/2014 Chu D7/412
 2002/0139884 A1 * 10/2002 Williams et al. 241/282.1
 2006/0176771 A1 * 8/2006 Adams 366/270
 2008/0198691 A1 * 8/2008 Behar et al. 366/205
 2009/0114616 A1 * 5/2009 White et al. 215/307
 2009/0134173 A1 * 5/2009 Liang et al. 220/563
 2009/0260236 A1 * 10/2009 Lin 30/265
 2012/0091245 A1 * 4/2012 Menashes 241/282.1

* cited by examiner

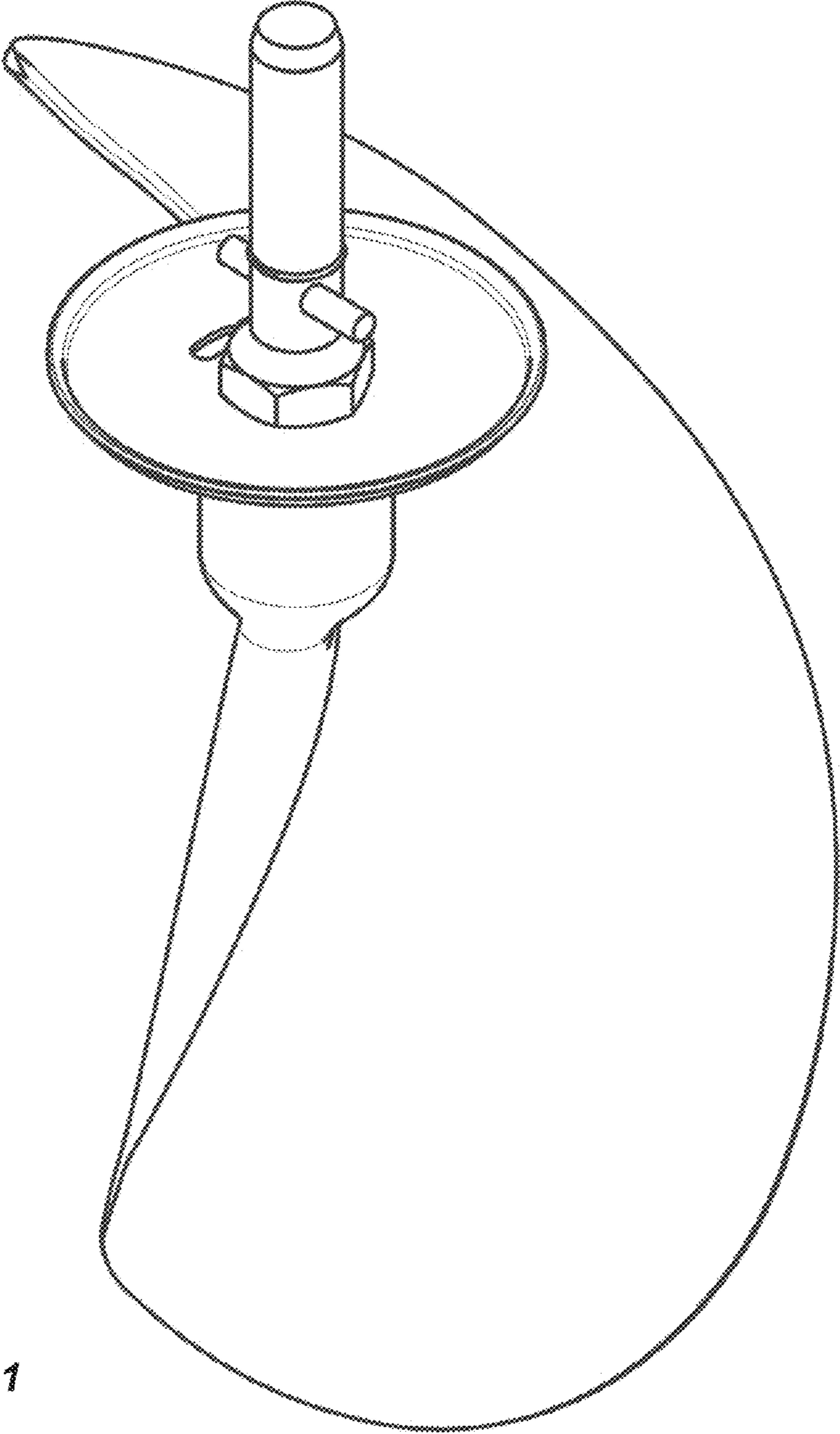

Figure 1

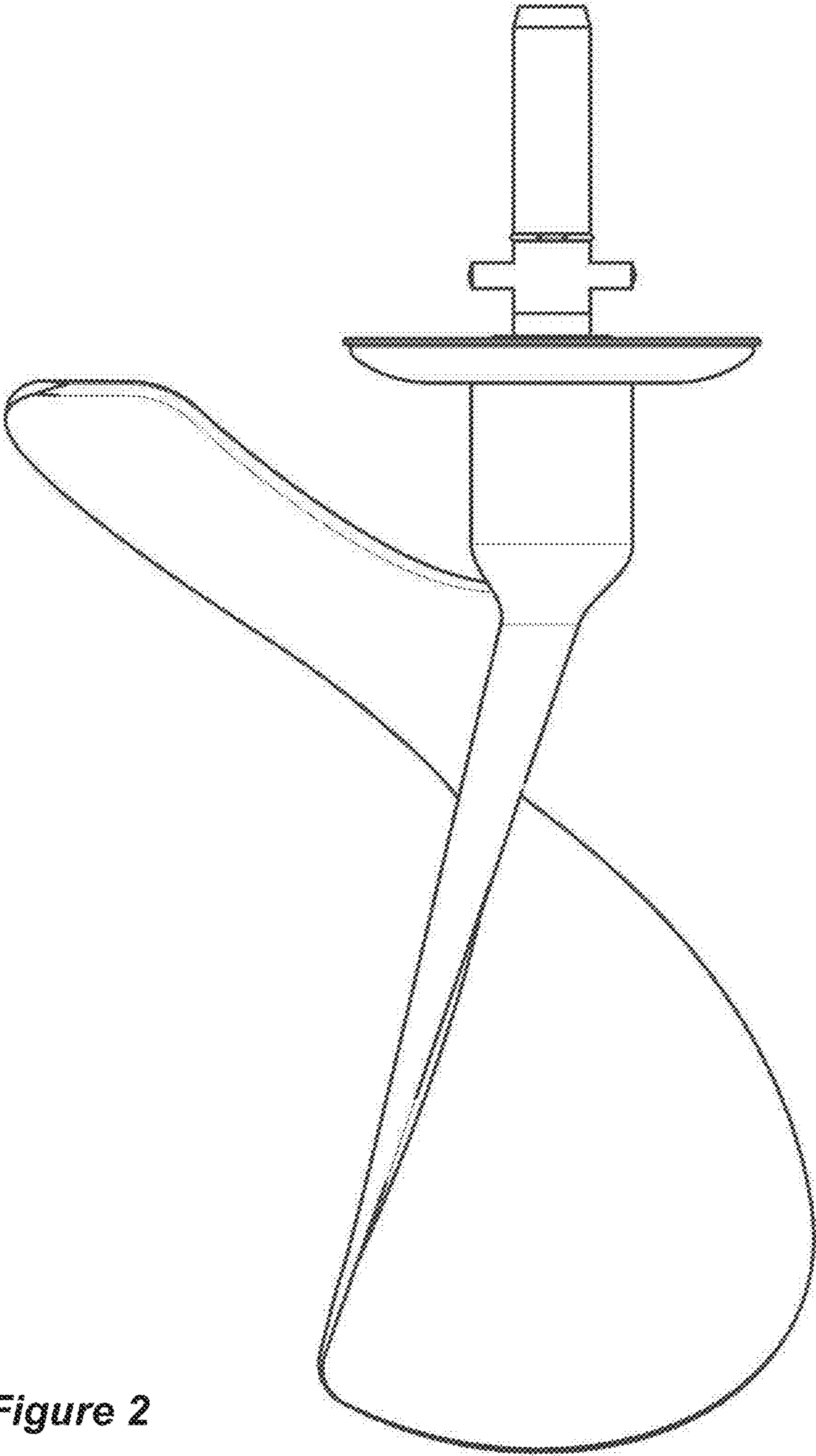

Figure 2

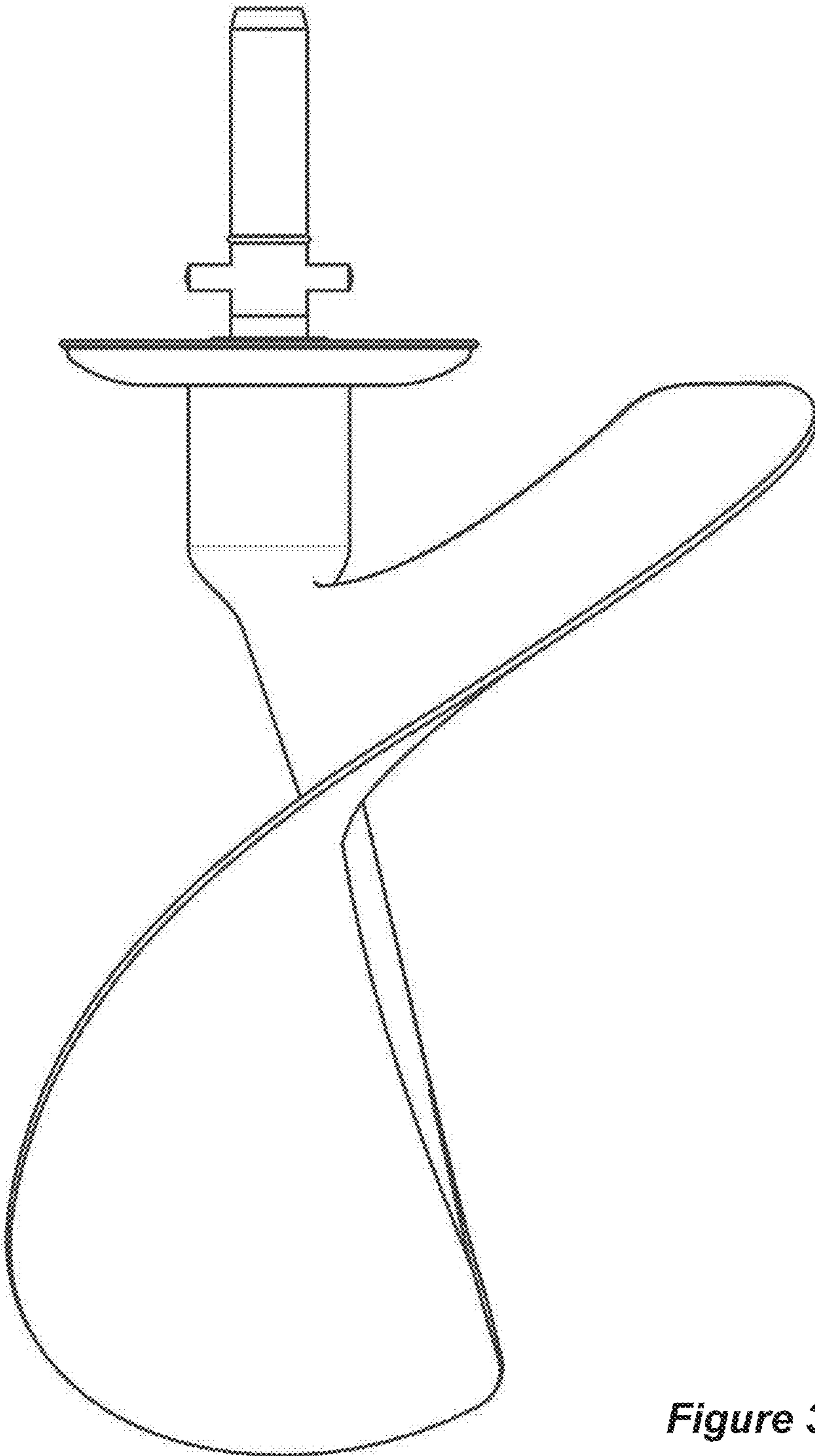

Figure 3

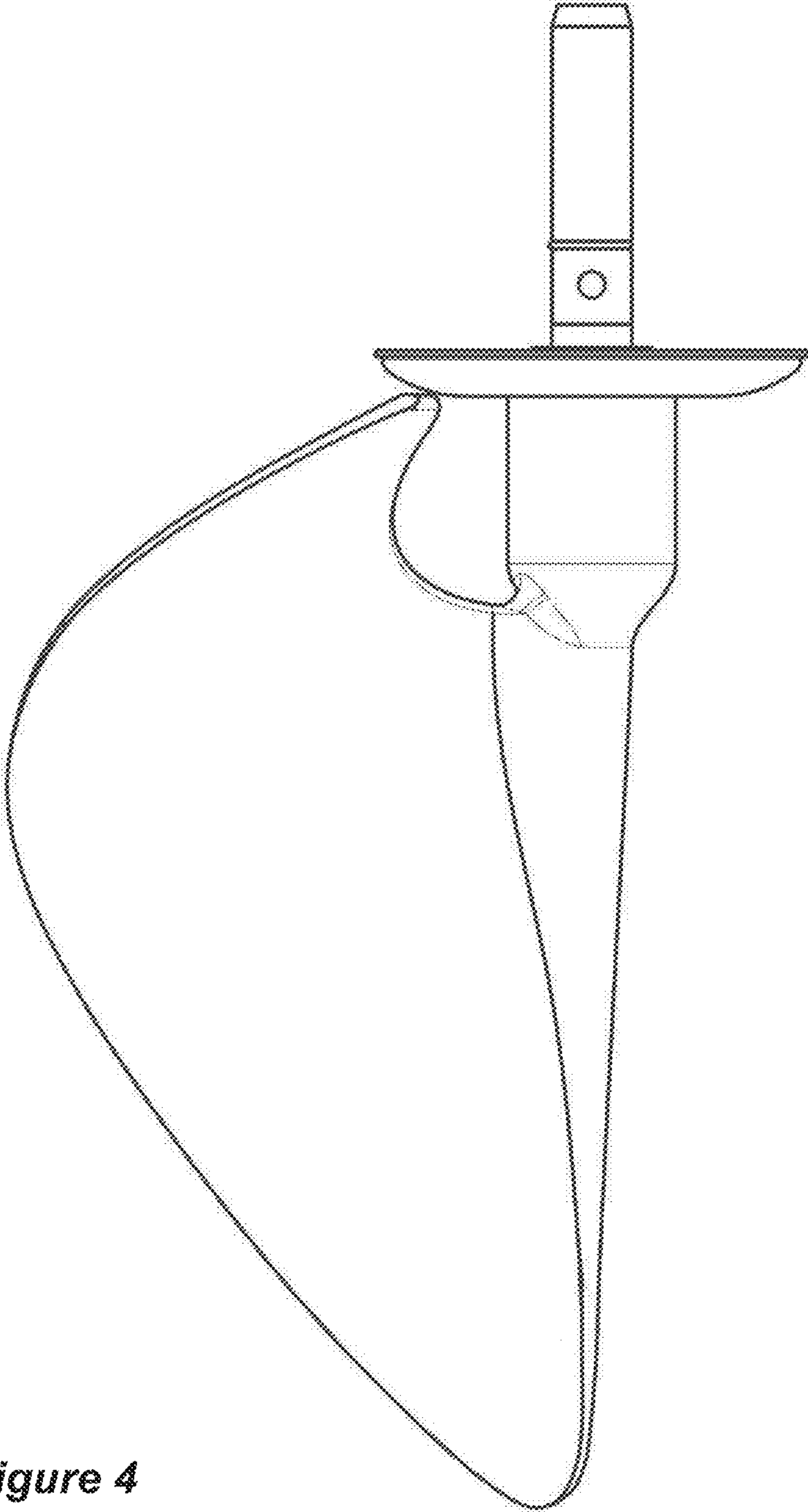

Figure 4

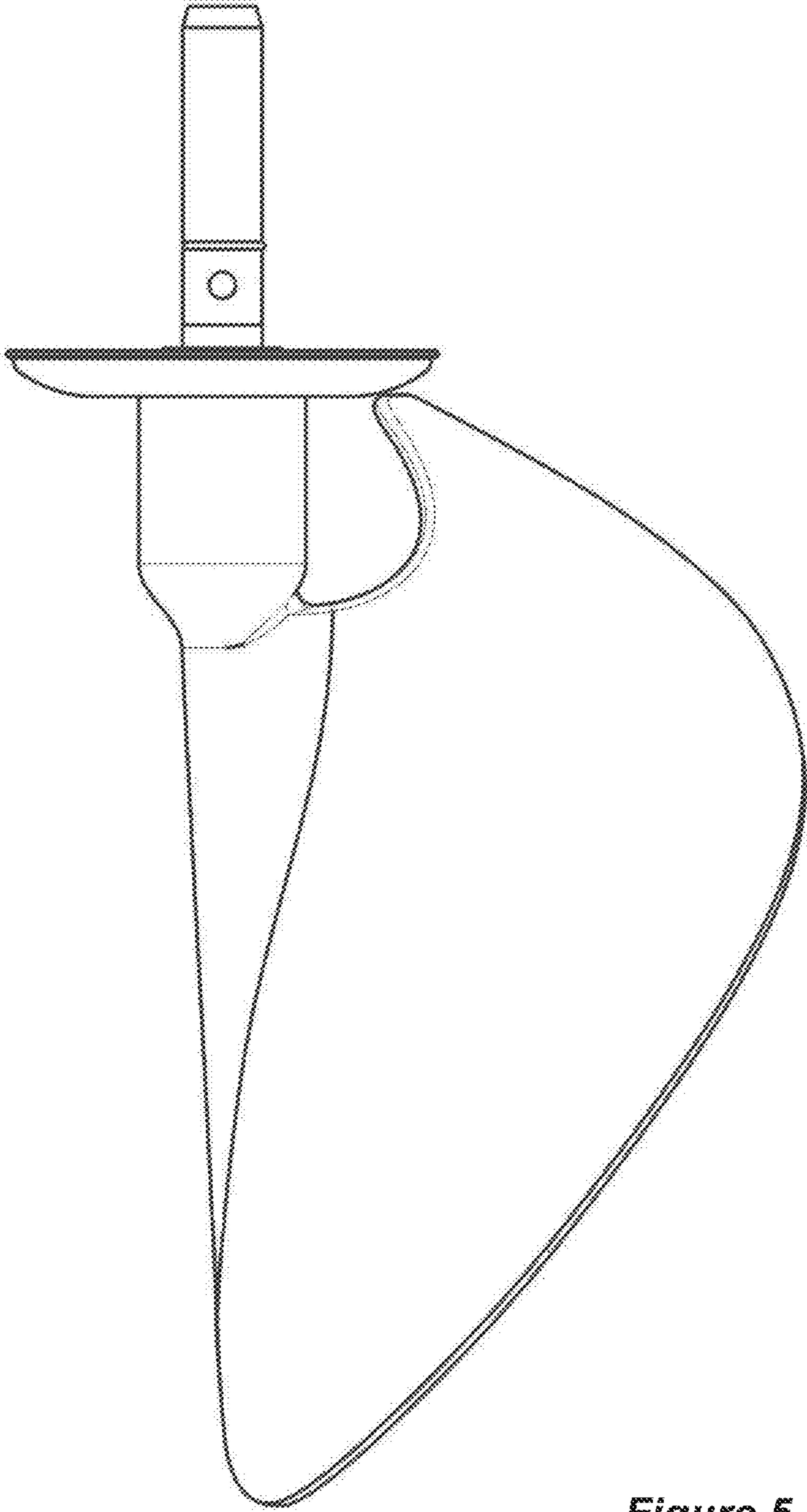

Figure 5

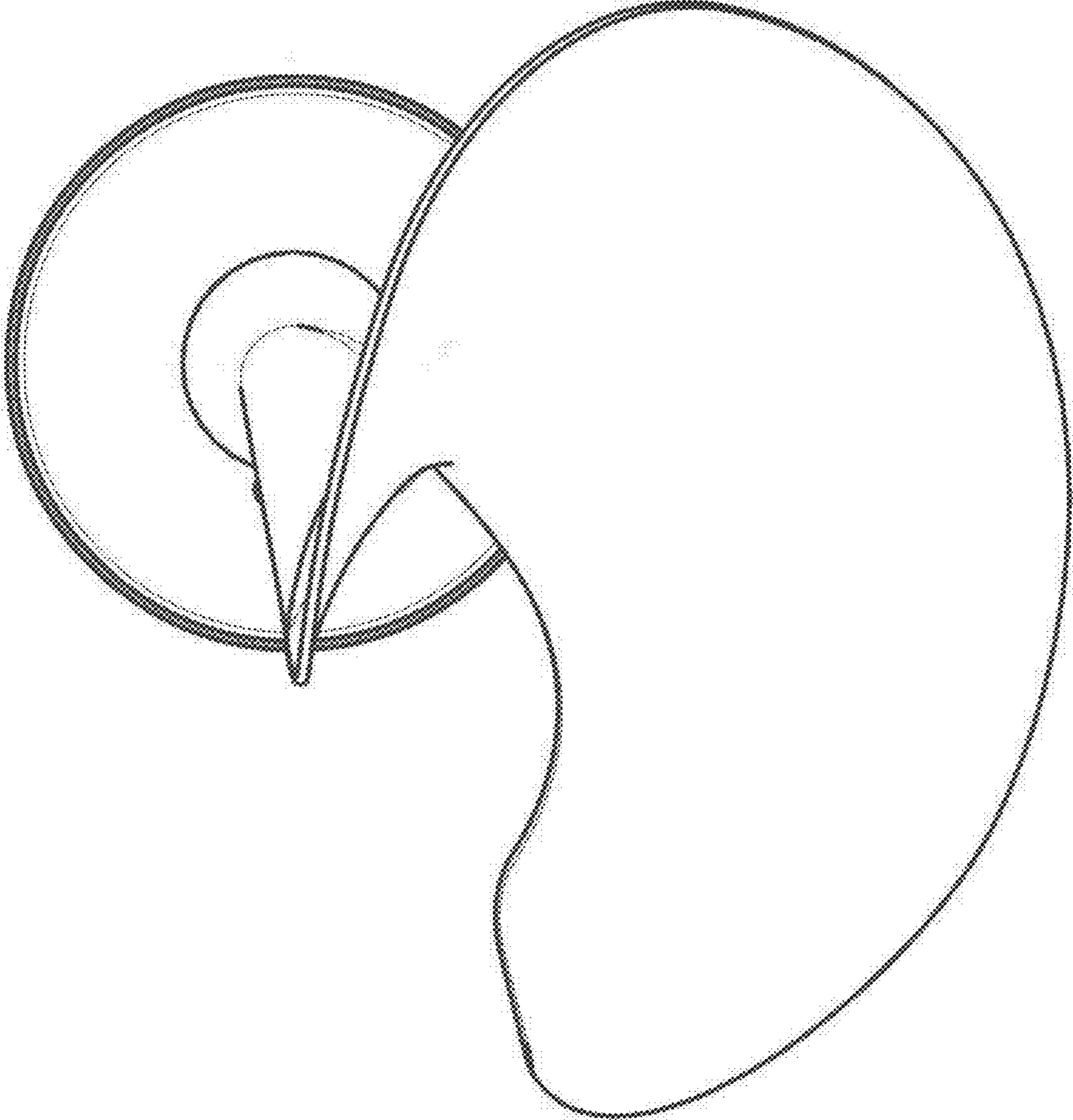

Figure 6

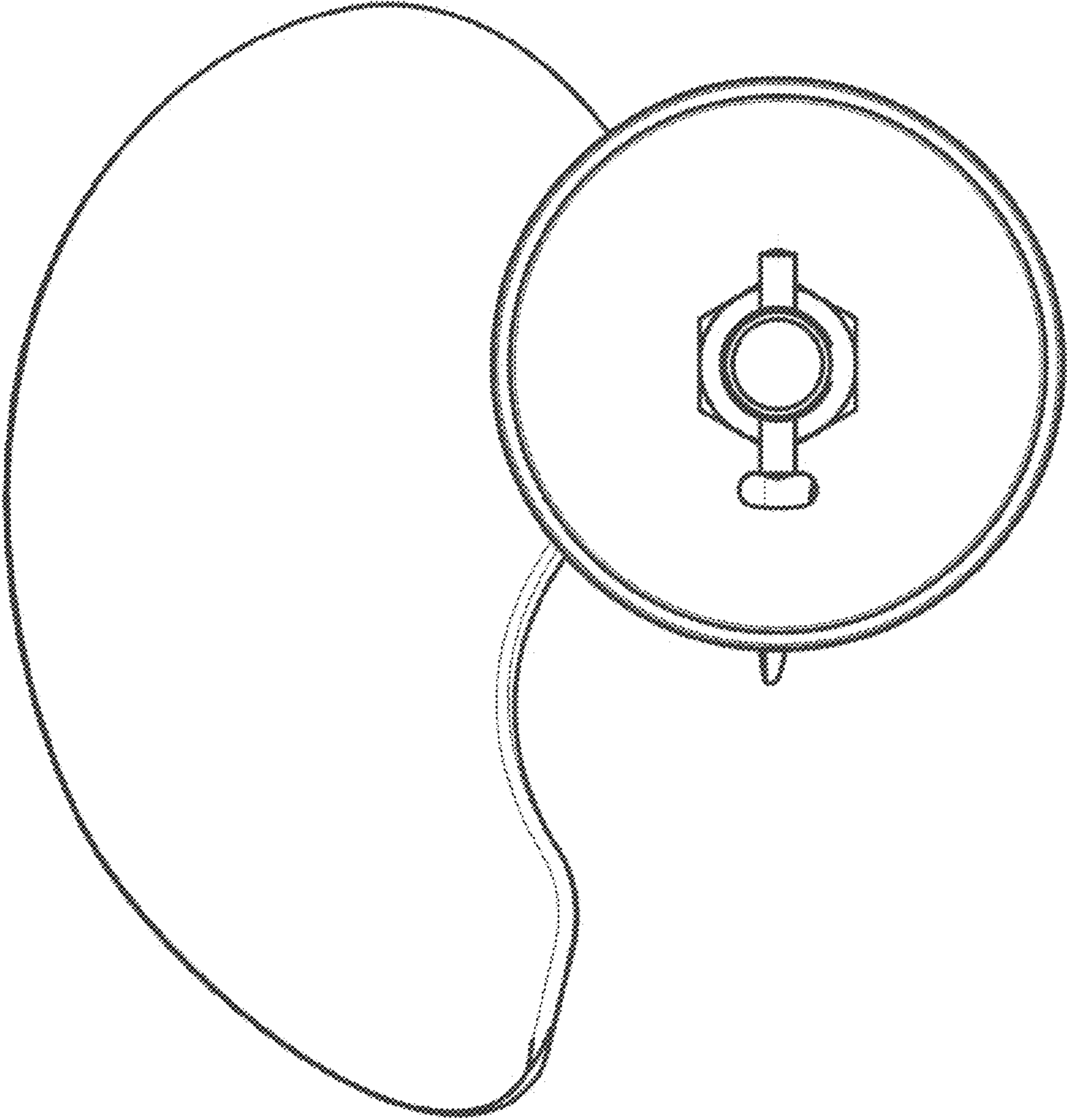

Figure 7

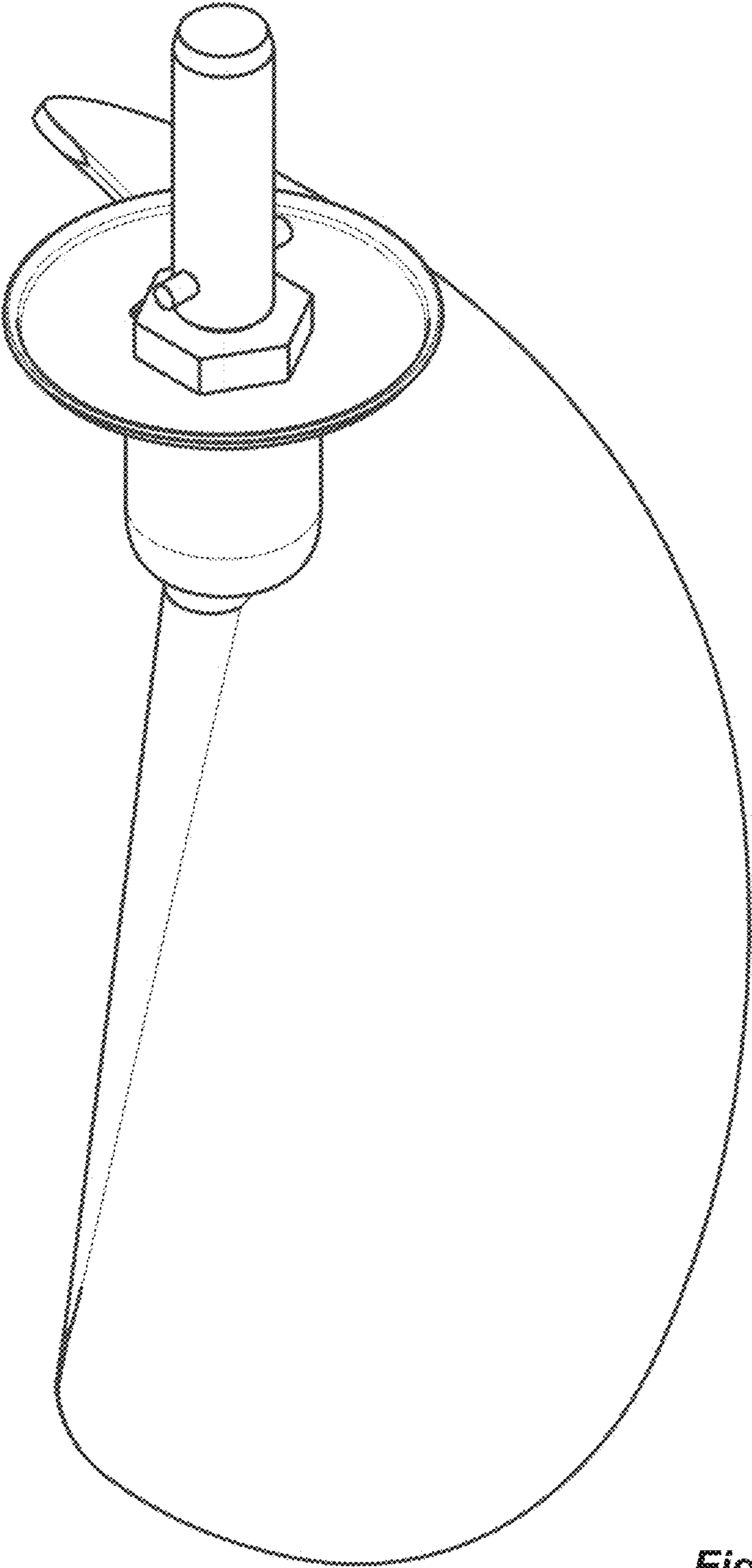

Figure 8

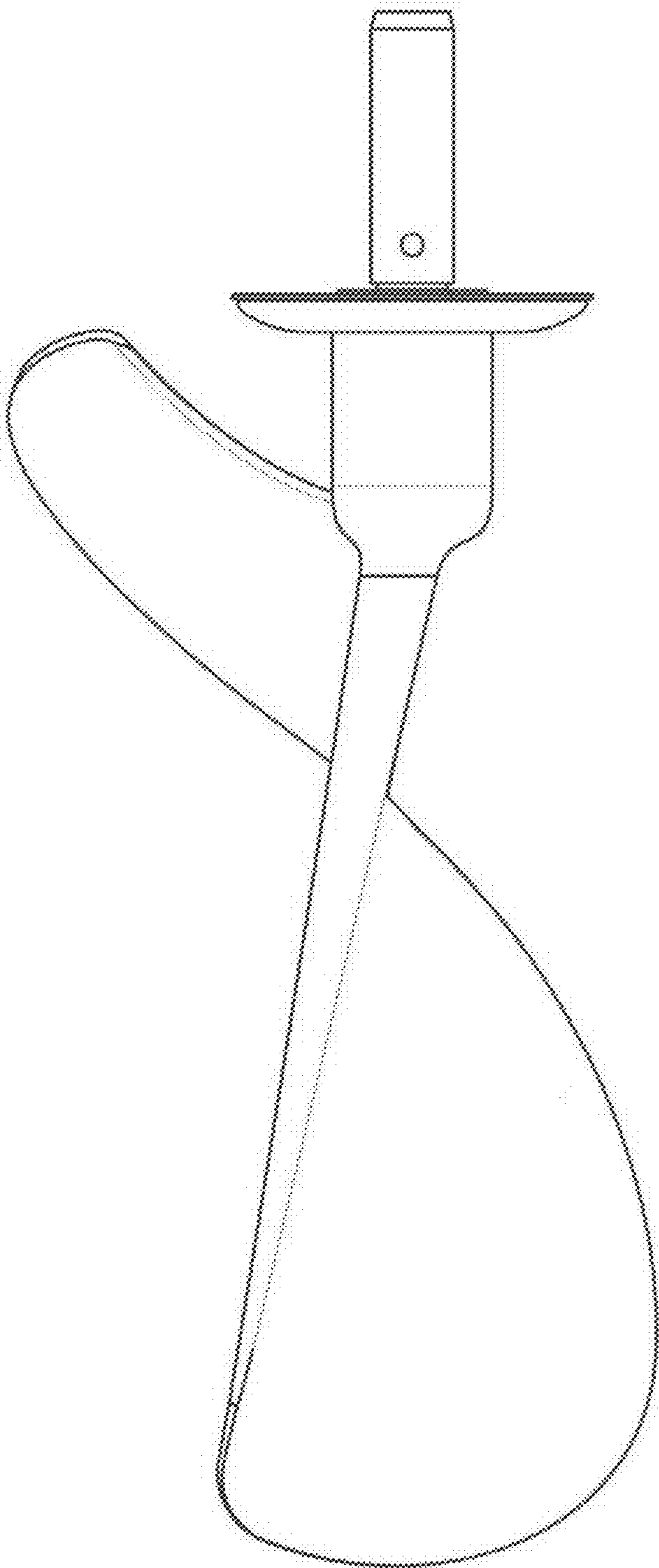

Figure 9

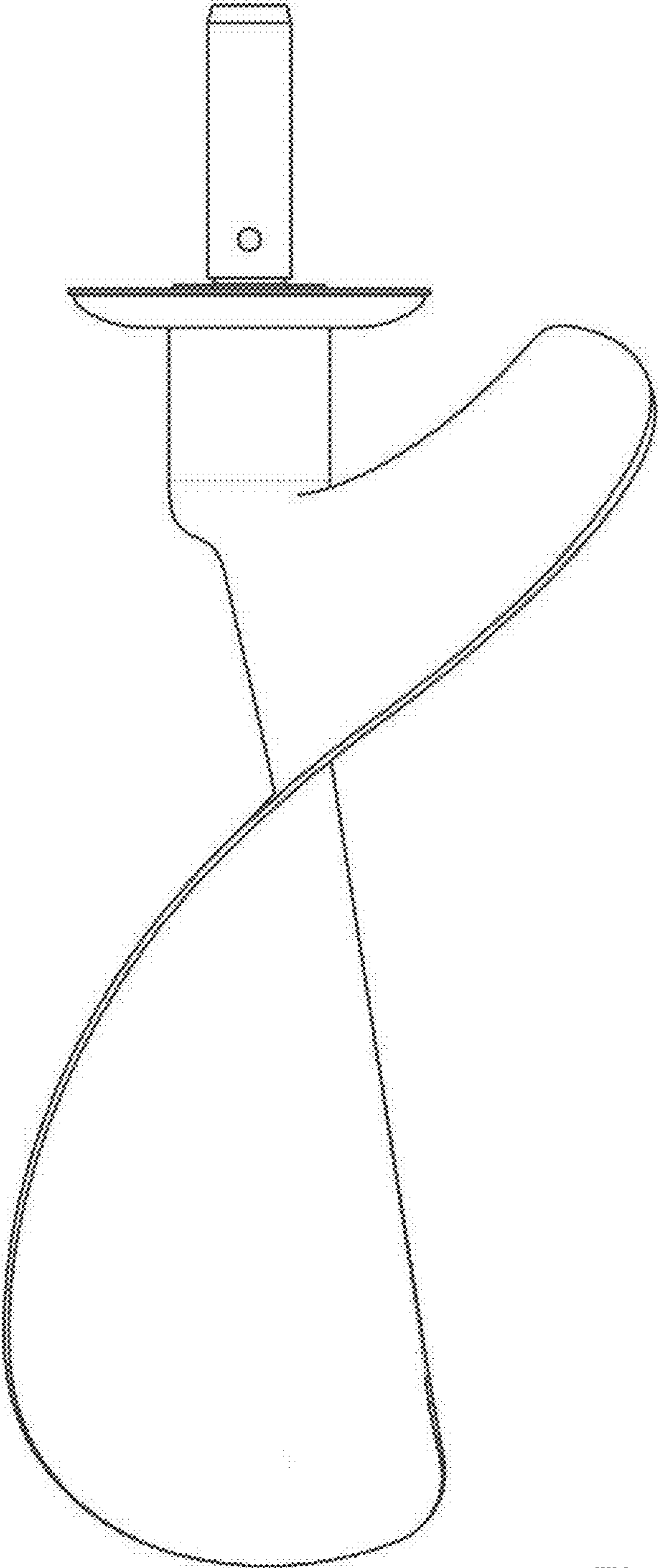

Figure 10

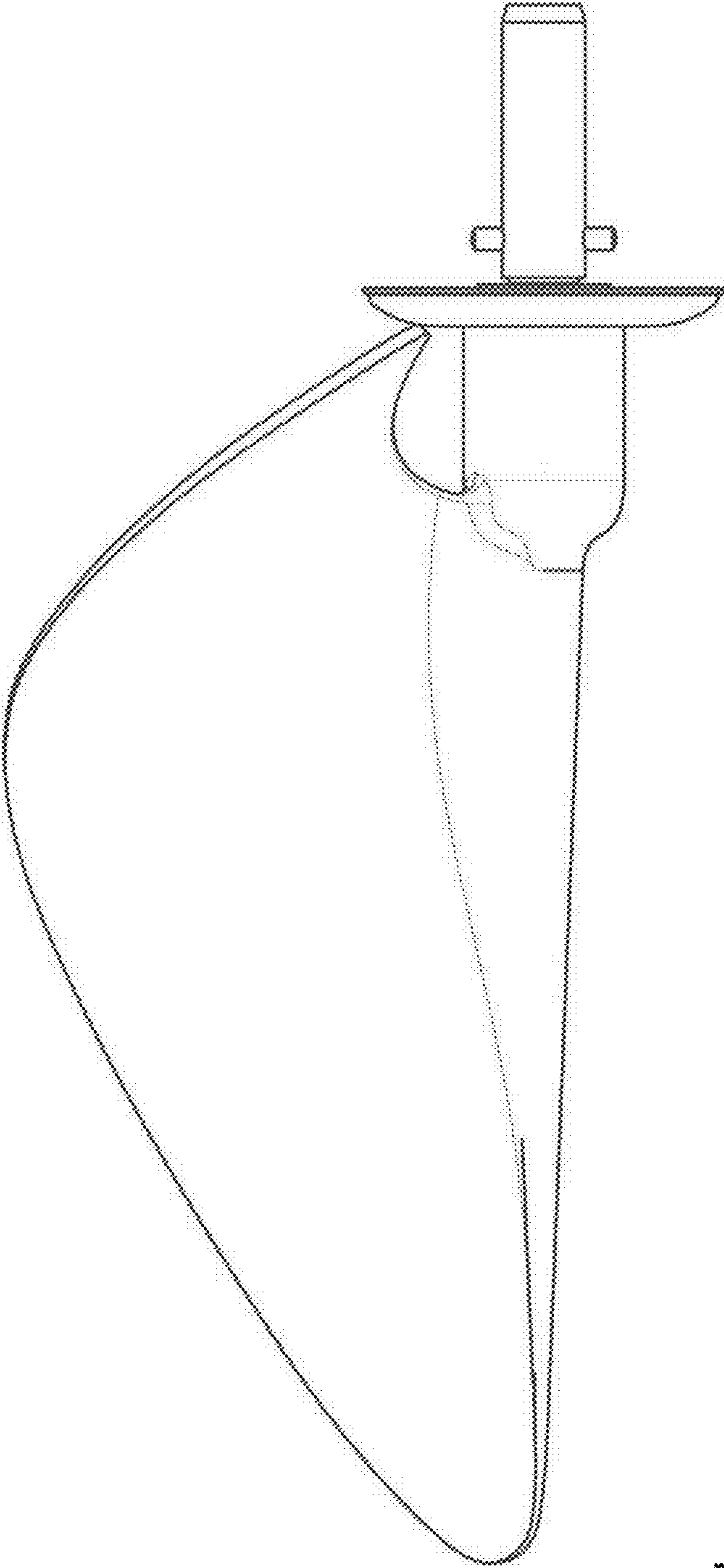

Figure 11

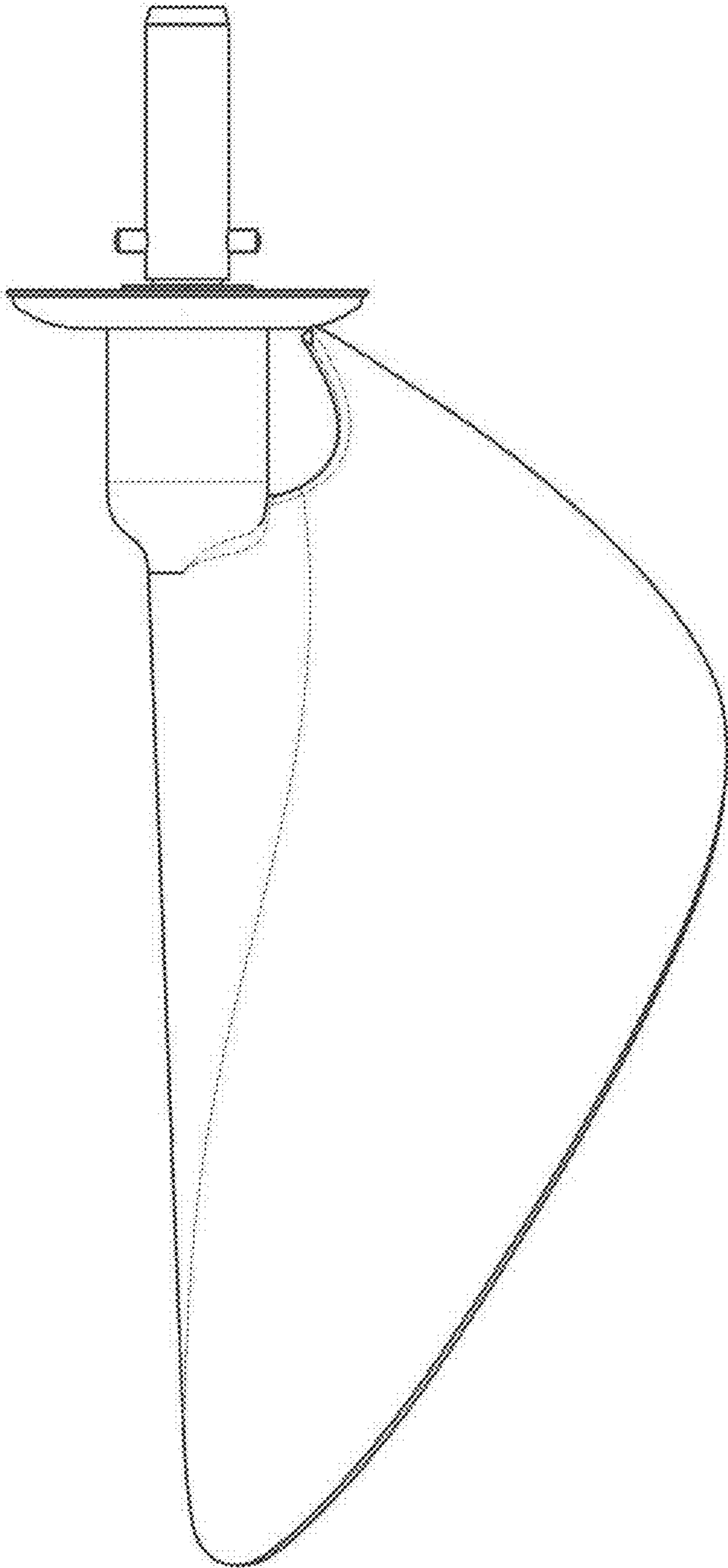

Figure 12

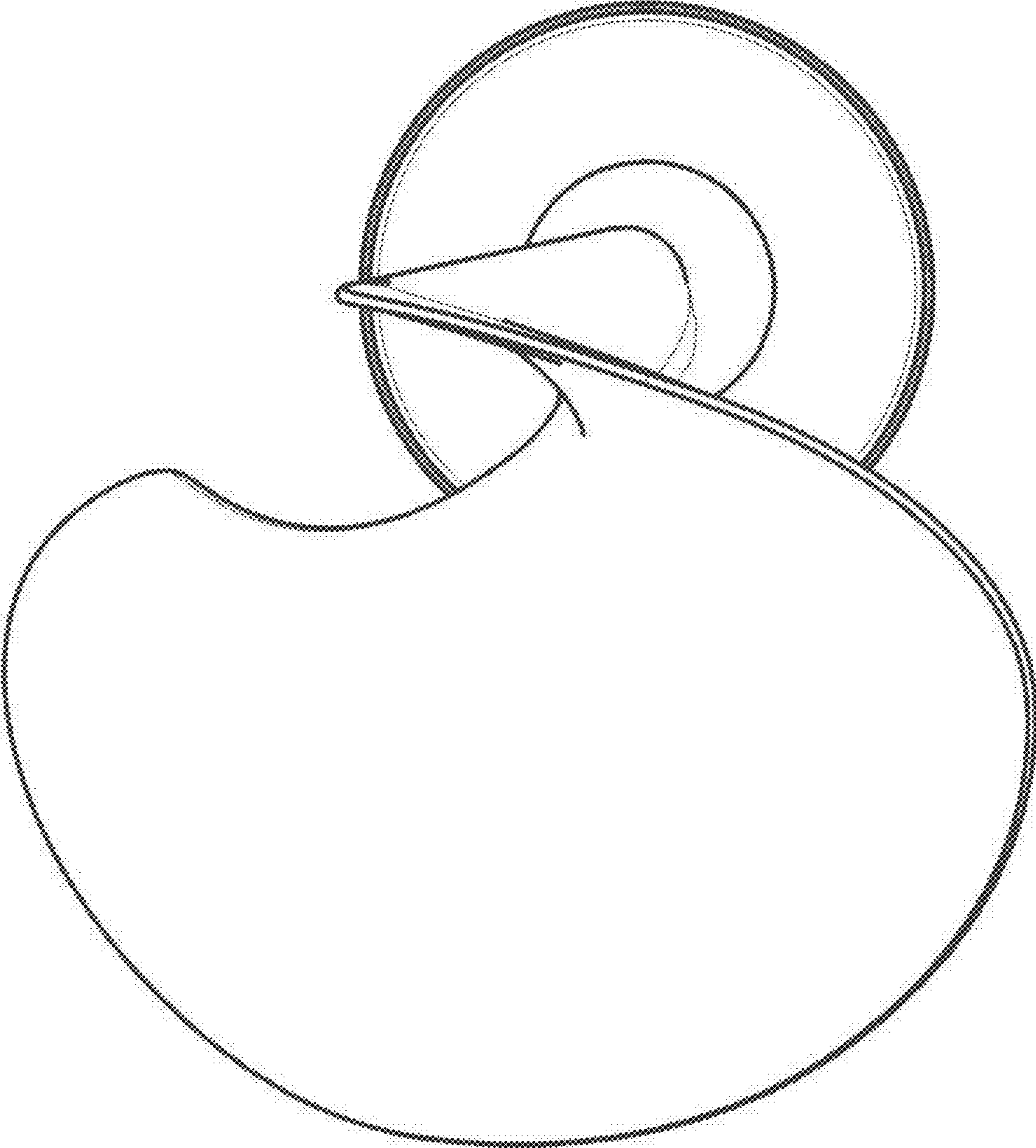

Figure 13

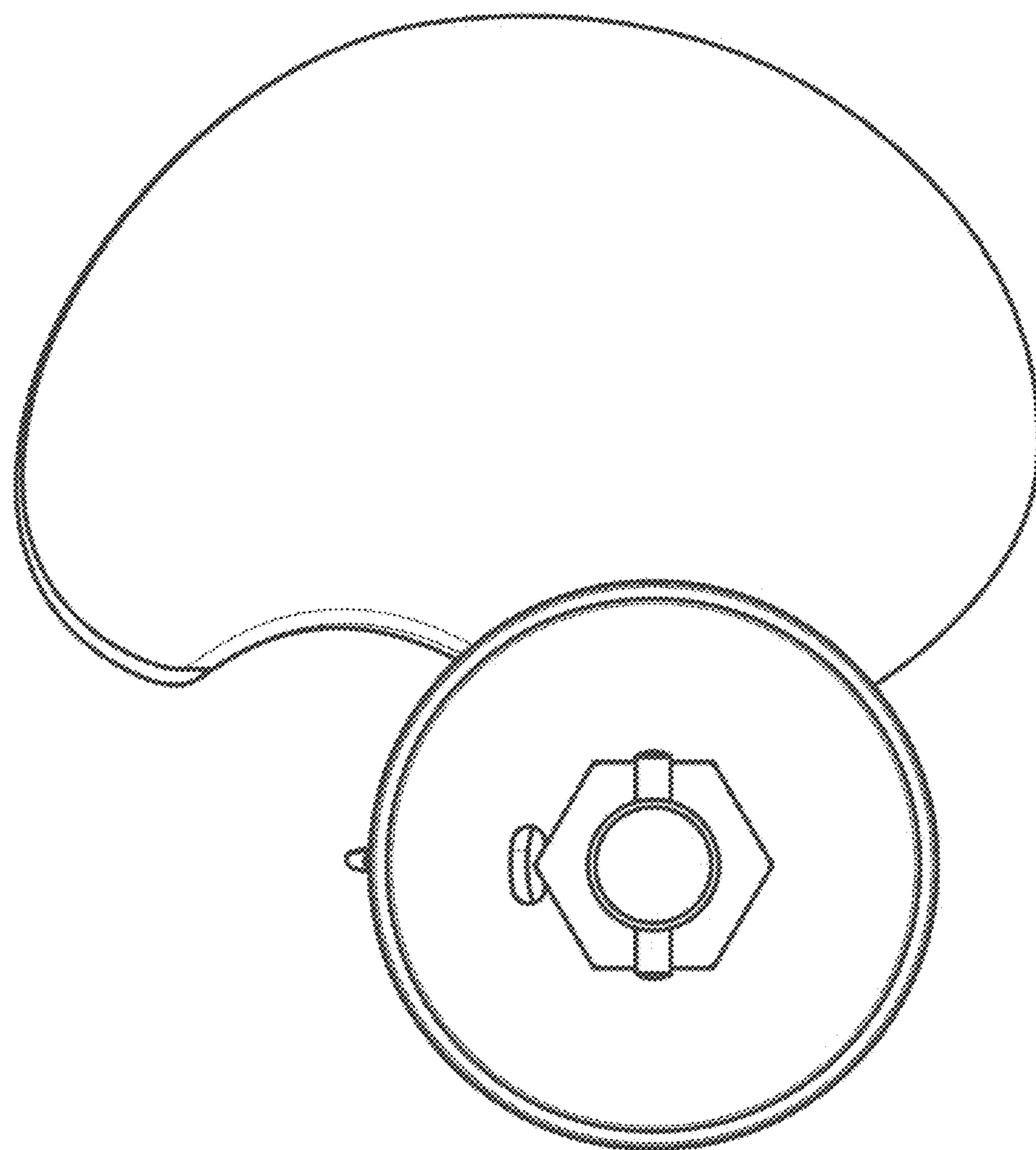

Figure 14