



US00D706546S

(12) **United States Design Patent**
Shukhman

(10) **Patent No.:** **US D706,546 S**
(45) **Date of Patent:** **** Jun. 10, 2014**

(54) **CHAIR**

(71) Applicant: **Alex J. Shukhman**, Emerson, NJ (US)

(72) Inventor: **Alex J. Shukhman**, Emerson, NJ (US)

(**) Term: **14 Years**

(21) Appl. No.: **29/464,098**

(22) Filed: **Aug. 13, 2013**

(51) **LOC (10) Cl.** **06-01**

(52) **U.S. Cl.**
USPC **D6/364**

(58) **Field of Classification Search**
CPC A47C 7/16; A47C 5/12; A47C 7/022;
A47C 7/40; A47C 1/12; A47C 3/12
USPC D6/334-336, 364, 365, 371-373, 374,
D6/375, 379, 380, 708.17, 716, 716.1,
D6/716.2, 716.3, 716.4; 297/451.11,
297/452.12, 452.14, 452.24, 452.29, 451.4,
297/DIG. 2

See application file for complete search history.

(56) **References Cited**

U.S. PATENT DOCUMENTS

2,764,228	A *	9/1956	Donohue	A47C 5/12
2,845,699	A *	8/1958	Woodard	A47C 3/12
D186,307	S *	10/1959	Kagan	D6/375
D188,417	S *	7/1960	Mason	D6/375
3,043,627	A *	7/1962	Torjusen	297/452.14
D201,879	S *	8/1965	Gale	D6/365
D202,424	S *	9/1965	Newsom	297/452.12

3,314,721	A *	4/1967	Smith	297/452.14
D211,169	S *	5/1968	Dwyer	D6/336
D211,462	S *	6/1968	Platner	D6/364
3,441,310	A *	4/1969	Gale	A47C 3/12
3,459,449	A *	8/1969	Klausen	A47C 5/12
3,561,818	A *	2/1971	Lohmeyer	A47C 5/12
D220,481	S *	4/1971	Aarnio	D6/365
D222,538	S *	11/1971	Bernard	D6/364
D224,867	S *	10/1972	Burke	D6/364
D225,294	S *	12/1972	Day	D6/375
D226,415	S *	3/1973	Duern	D6/374
D226,644	S *	4/1973	Kogoj	D6/365
D235,286	S *	6/1975	Martinelli	D6/372
D239,743	S *	5/1976	Losada	D6/365

* cited by examiner

Primary Examiner — Mimoso De

(57) **CLAIM**

The ornamental design for a chair, as shown and described.

DESCRIPTION

FIG. 1 is a perspective view of the front and side of a chair design thereof;

FIG. 2 is a front elevational view thereof;

FIG. 3 is a left side elevational view thereof;

FIG. 4 is a back elevational view thereof;

FIG. 5 is a right side elevational view thereof;

FIG. 6 is a top plan view thereof; and,

FIG. 7 is a bottom plan view thereof.

The broken lines are directed to environment and are for illustrative purposes only.

The broken lines form no part of the claimed design.

1 Claim, 6 Drawing Sheets

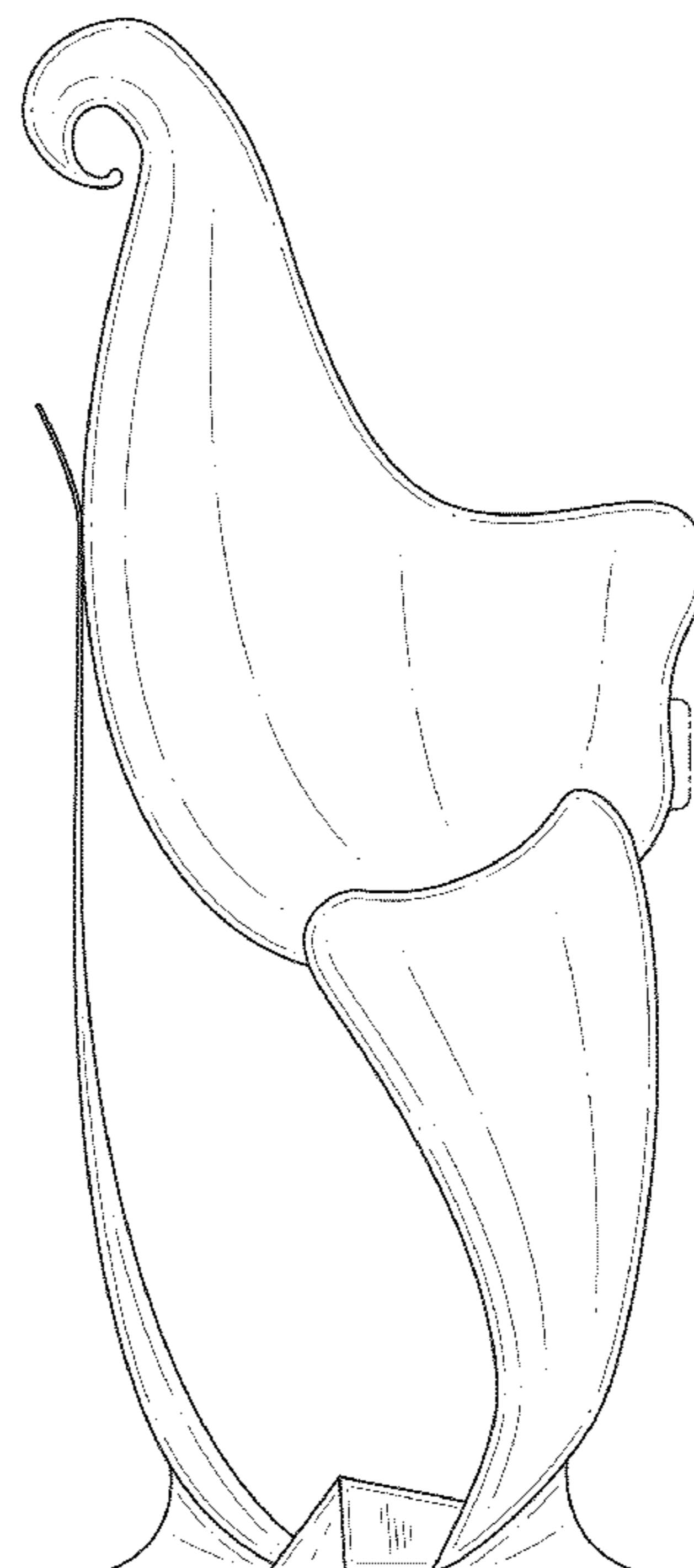
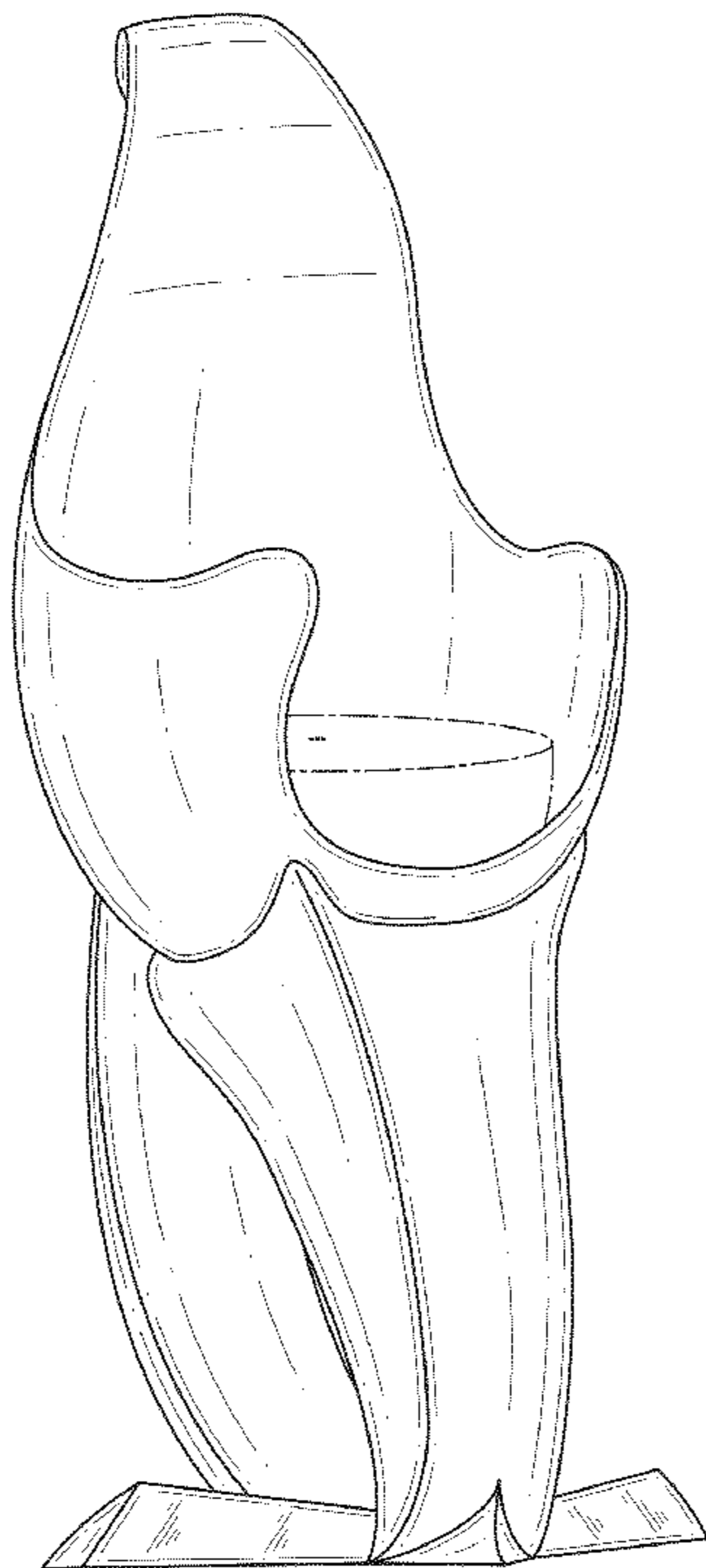

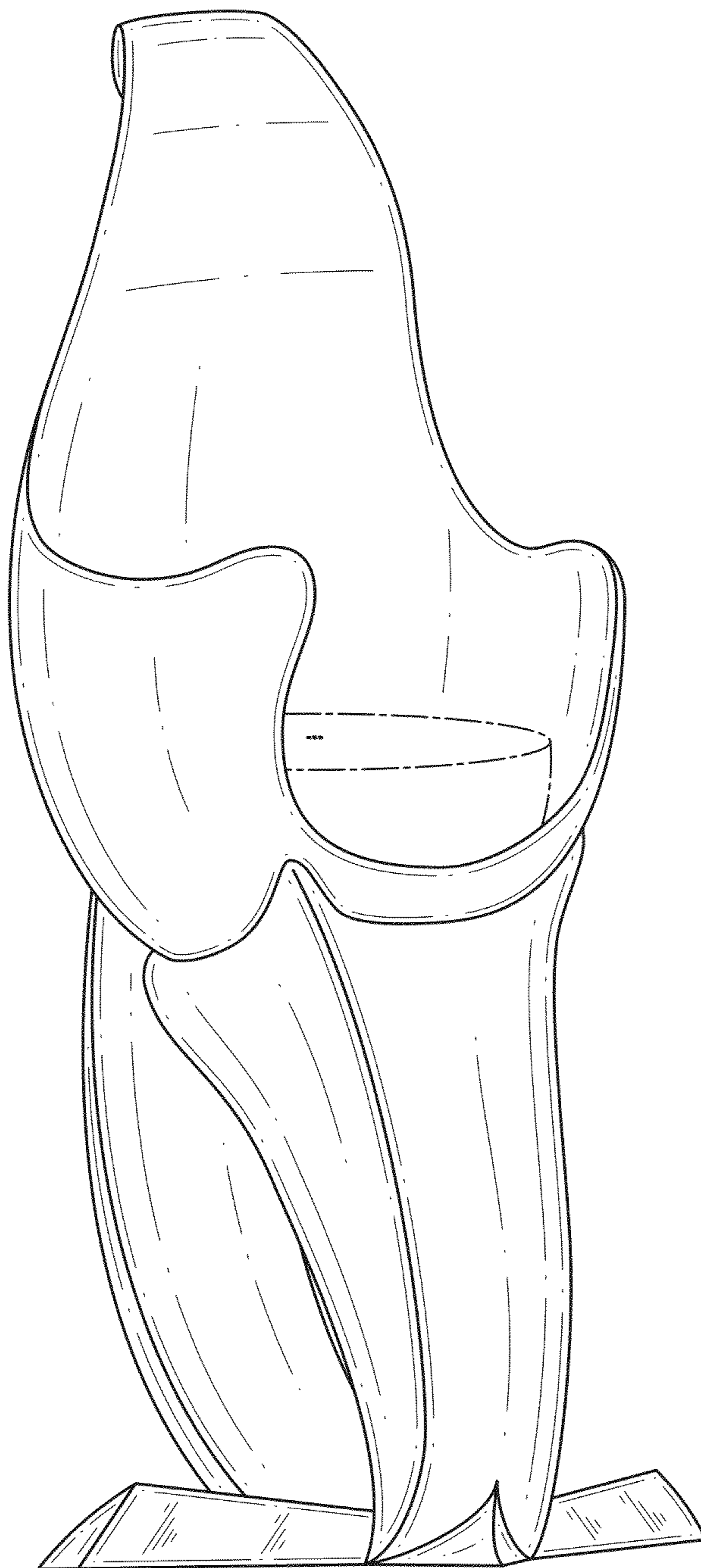

FIG. 1

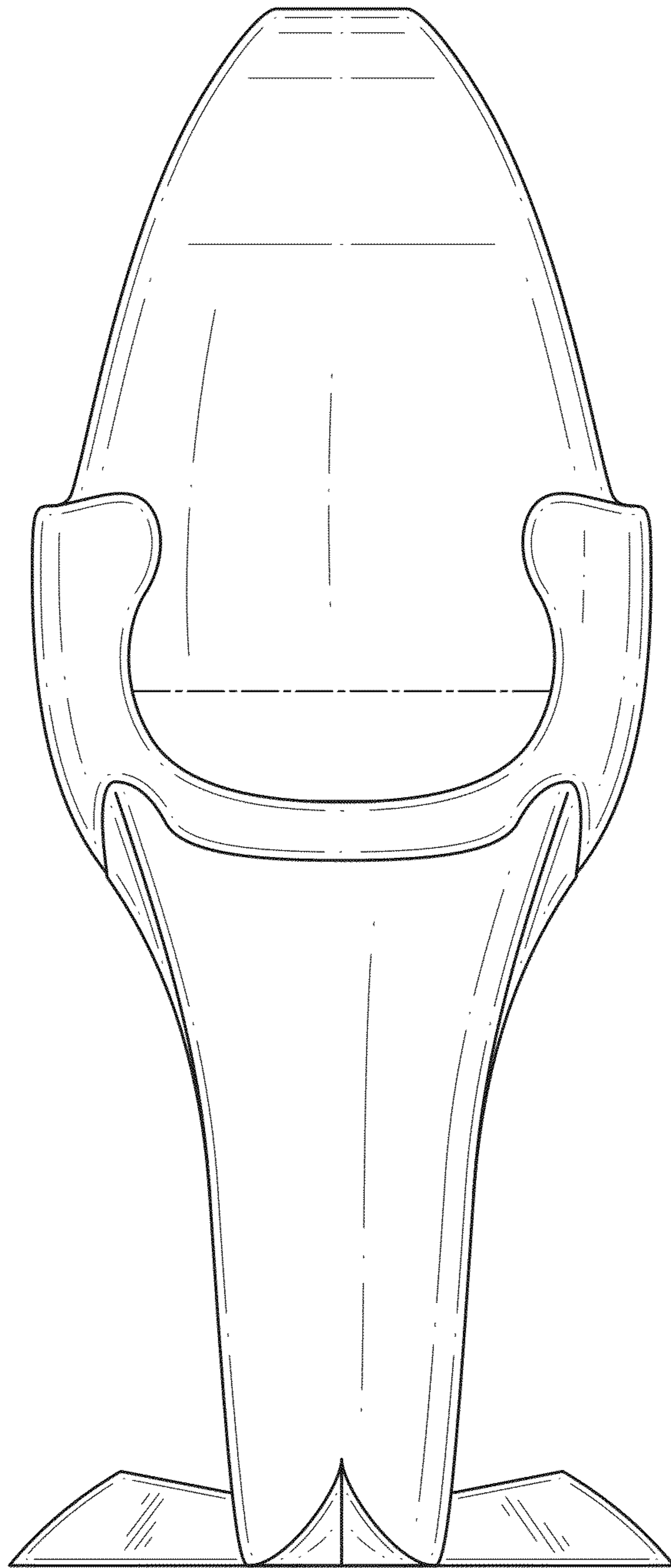

FIG. 2

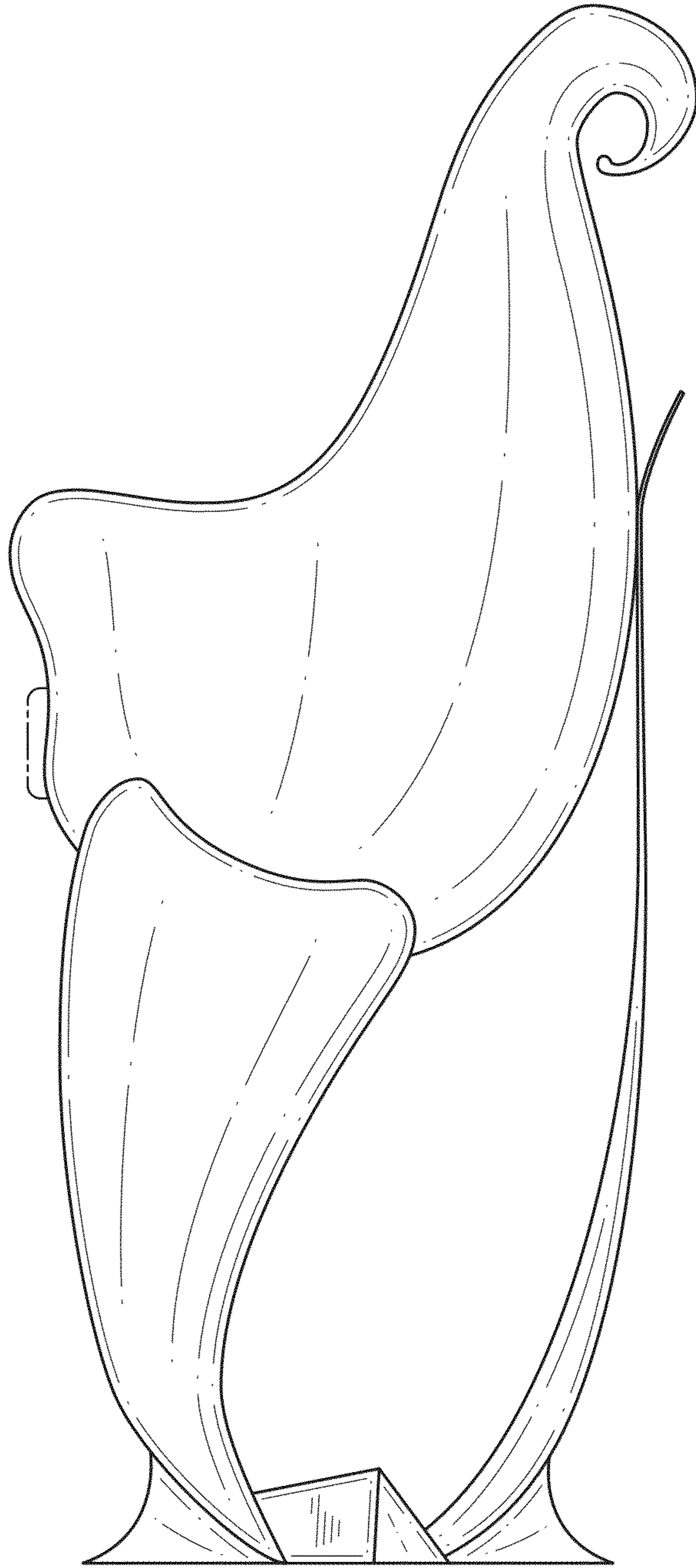

FIG. 3

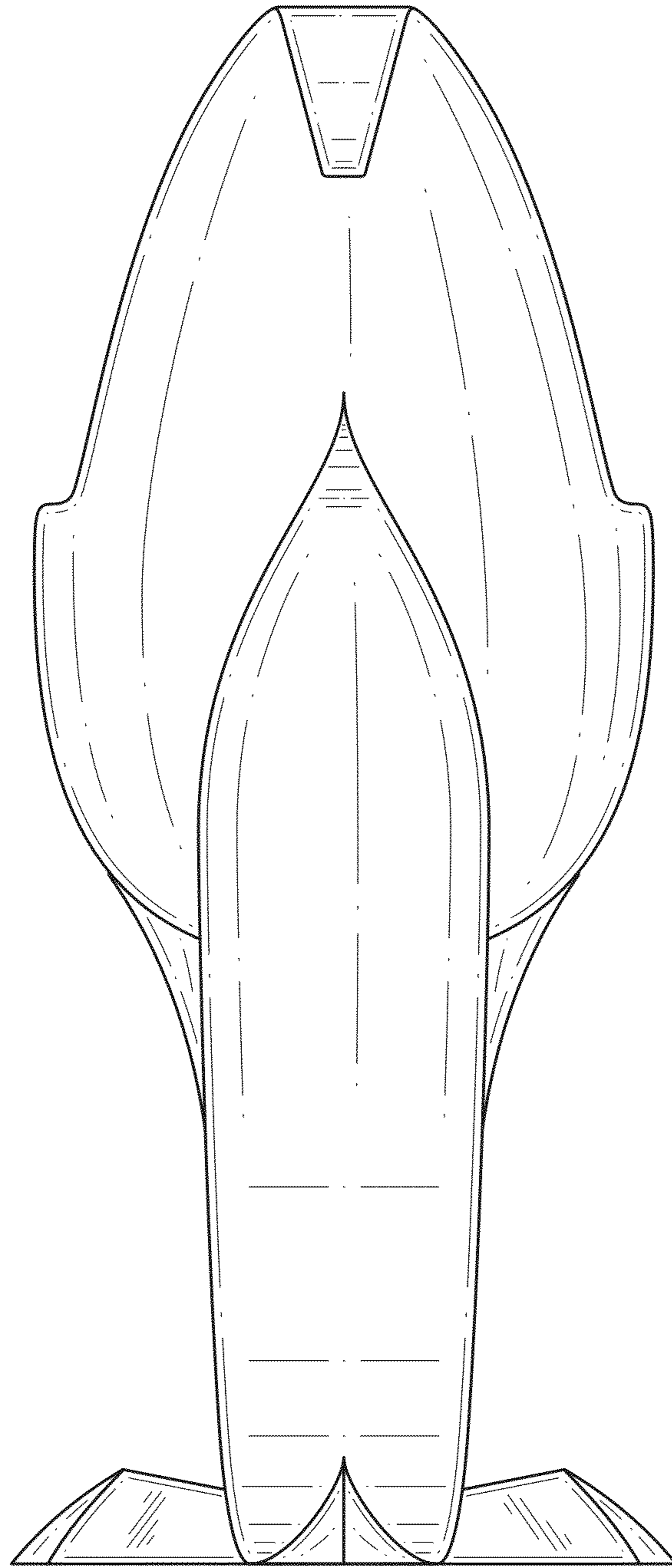

FIG. 4

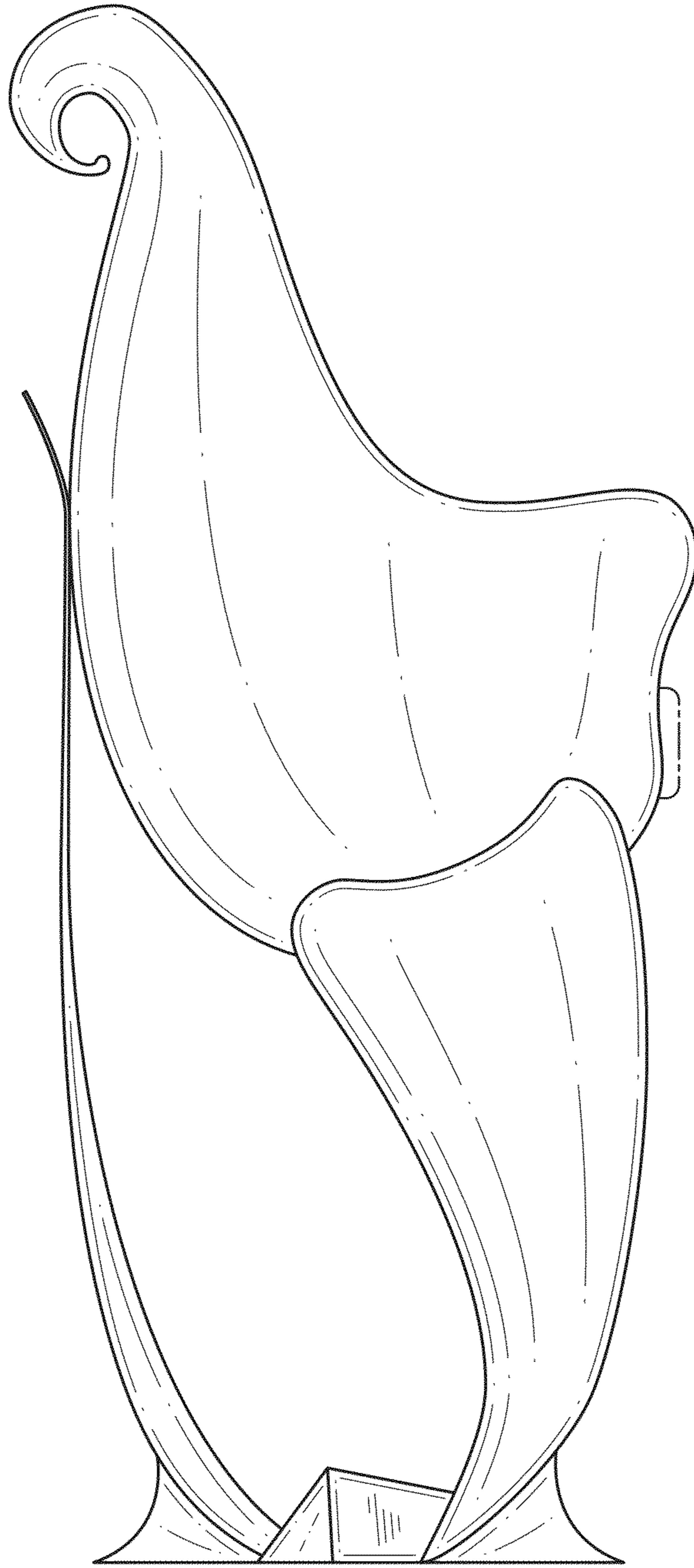

FIG. 5

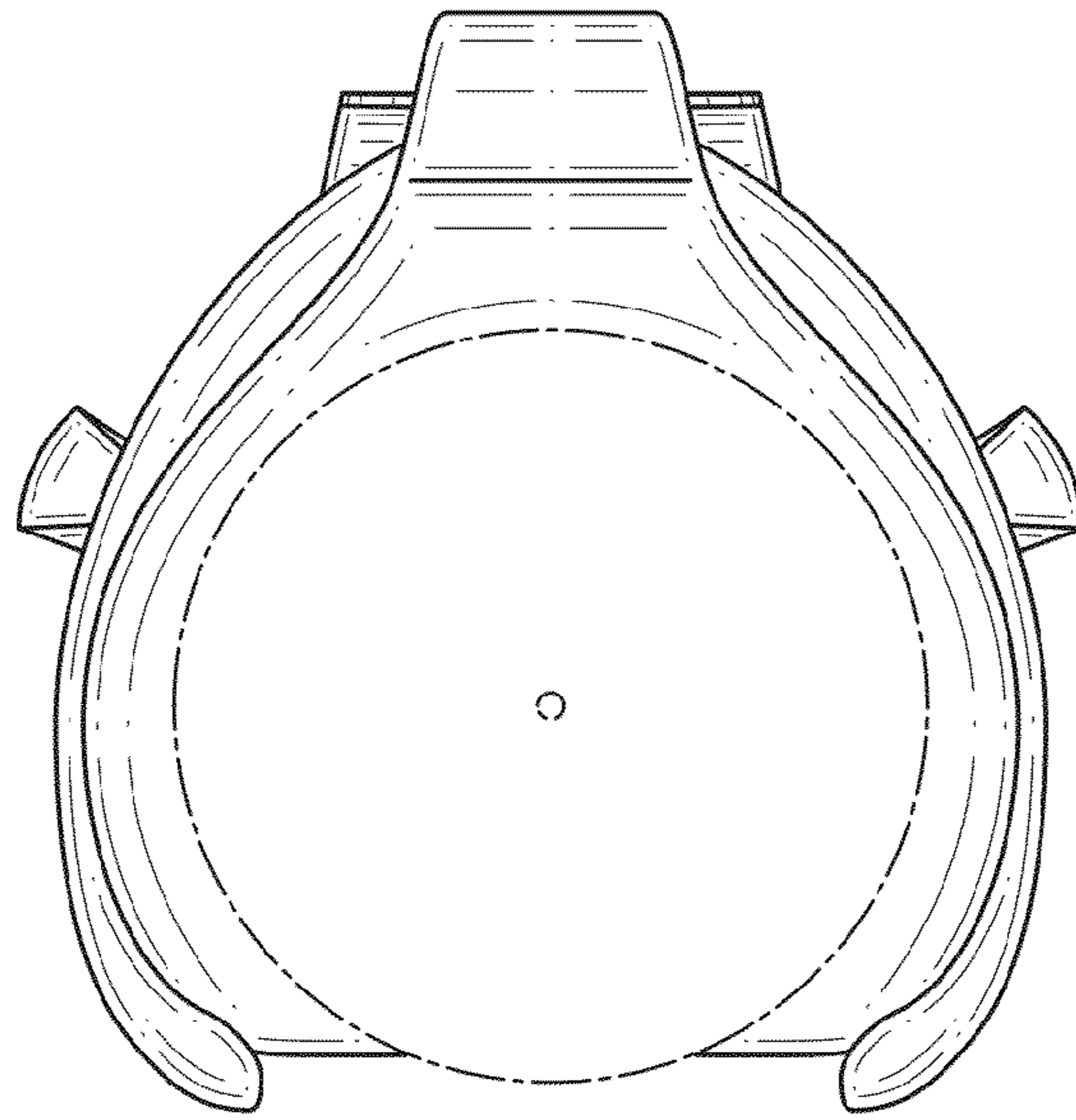

FIG. 6

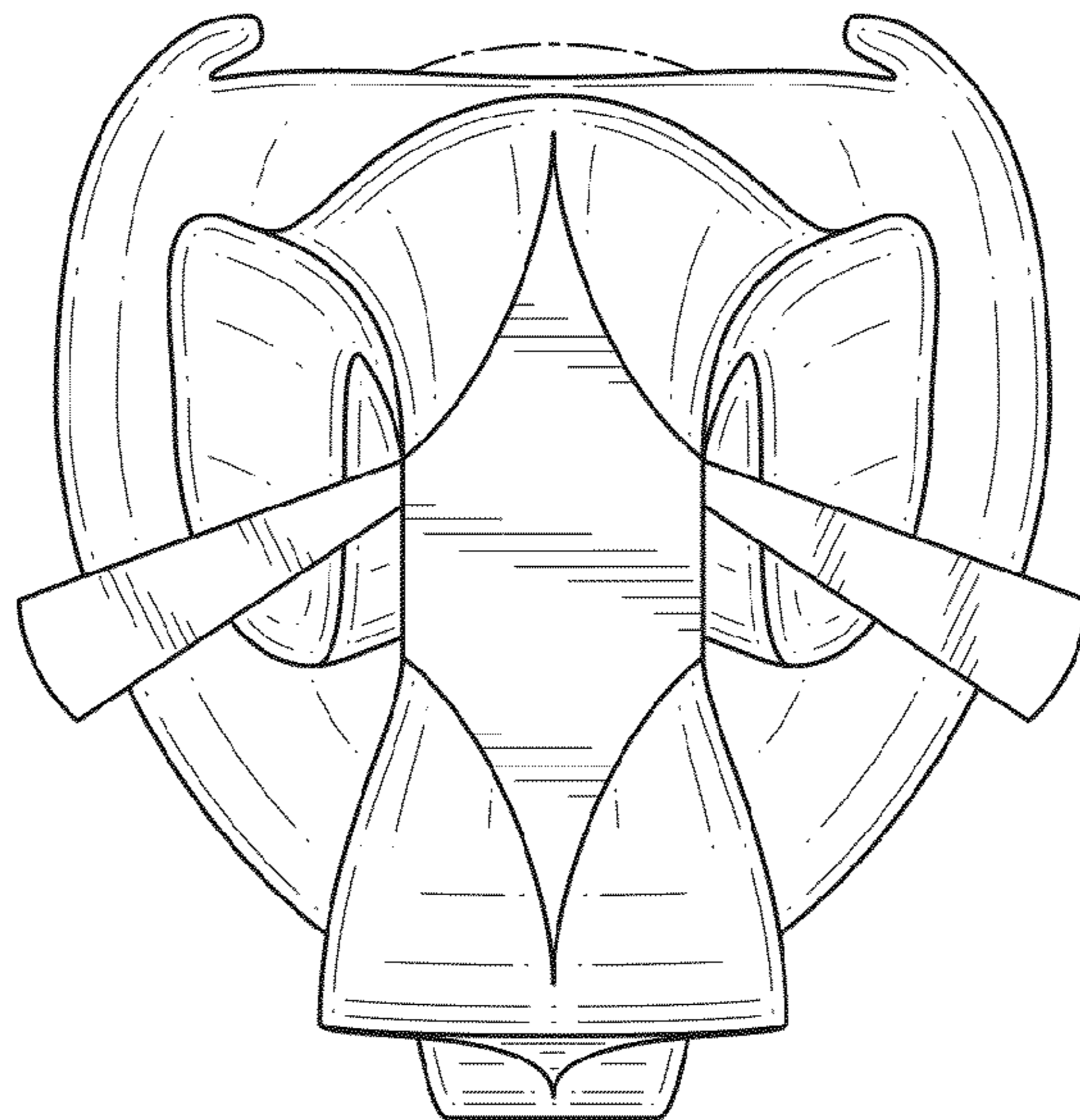

FIG. 7