



US00D706464S

(12) **United States Design Patent**
Rochat et al.

(10) **Patent No.:** **US D706,464 S**
(45) **Date of Patent:** **** Jun. 3, 2014**

(54) **LED BULB HEATSINK**

- (71) Applicant: **Switch Bulb Company, Inc.**, San Jose, CA (US)
- (72) Inventors: **Alex Rochat**, Emeryville, CA (US); **Jeff Salazar**, Palo Alto, CA (US); **David Titzler**, Palo Alto, CA (US); **Andrew Webb**, San Jose, CA (US)
- (73) Assignee: **Switch Bulb Company, Inc.**, San Jose, CA (US)
- (**) Term: **14 Years**
- (21) Appl. No.: **29/465,162**
- (22) Filed: **Aug. 23, 2013**

Related U.S. Application Data

- (63) Continuation of application No. 29/410,660, filed on Jan. 10, 2012, now Pat. No. Des. 689,632.
- (51) **LOC (10) Cl.** **26-04**
- (52) **U.S. Cl.**
USPC **D26/2**
- (58) **Field of Classification Search**
USPC D26/1-4; 313/313, 315, 316, 317, 318, 313/493; 315/52, 53, 56, 57, 58
See application file for complete search history.

(56) **References Cited**

U.S. PATENT DOCUMENTS

D617,475 S	6/2010	Hiraga et al.	
D632,406 S	2/2011	Wei	
D648,461 S	11/2011	Kim et al.	
D653,366 S	1/2012	Le et al.	
D654,193 S *	2/2012	Tong et al.	D26/2
D656,252 S *	3/2012	Engl et al.	D26/2
D679,035 S *	3/2013	Le et al.	D26/2
D696,437 S *	12/2013	Webb et al.	D26/2

OTHER PUBLICATIONS

Office Action received for Japanese Patent Application No. 2012-016404, mailed on Nov. 13, 2012, 2 pages (1 page of English Translation and 1 page of Office Action).
Notice of Allowance received for U.S. Appl. No. 29/410,660, mailed on Apr. 26, 2013, 9 pages.

* cited by examiner

Primary Examiner — Marcus Jackson

(74) *Attorney, Agent, or Firm* — Morrison & Foerster LLP

(57) **CLAIM**

The ornamental design for an LED bulb heatsink, as shown and described.

DESCRIPTION

FIG. 1 is a perspective view of a first embodiment of an LED bulb heatsink;
FIG. 2 is a side view of the first embodiment;
FIG. 3 is a top view of the first embodiment;
FIG. 4 is a bottom view of the first embodiment;
FIG. 5 is a perspective view of a second embodiment of an LED bulb heatsink;
FIG. 6 is a side view of the second embodiment;
FIG. 7 is a top view of the second embodiment;
FIG. 8 is a bottom view of the second embodiment;
FIG. 9 is a perspective view of a third embodiment of an LED bulb heatsink;
FIG. 10 is a side view of the third embodiment;
FIG. 11 is a top view of the third embodiment;
FIG. 12 is a bottom view of the third embodiment;
FIG. 13 is a perspective view of a fourth embodiment of an LED bulb heatsink;
FIG. 14 is a side view of the fourth embodiment;
FIG. 15 is a top view of the fourth embodiment; and,
FIG. 16 is a bottom view of the fourth embodiment.
The broken line showing of the upper and lower portions of the bulb is included for the purpose of illustrating only and forms no part of the claimed design.

1 Claim, 12 Drawing Sheets

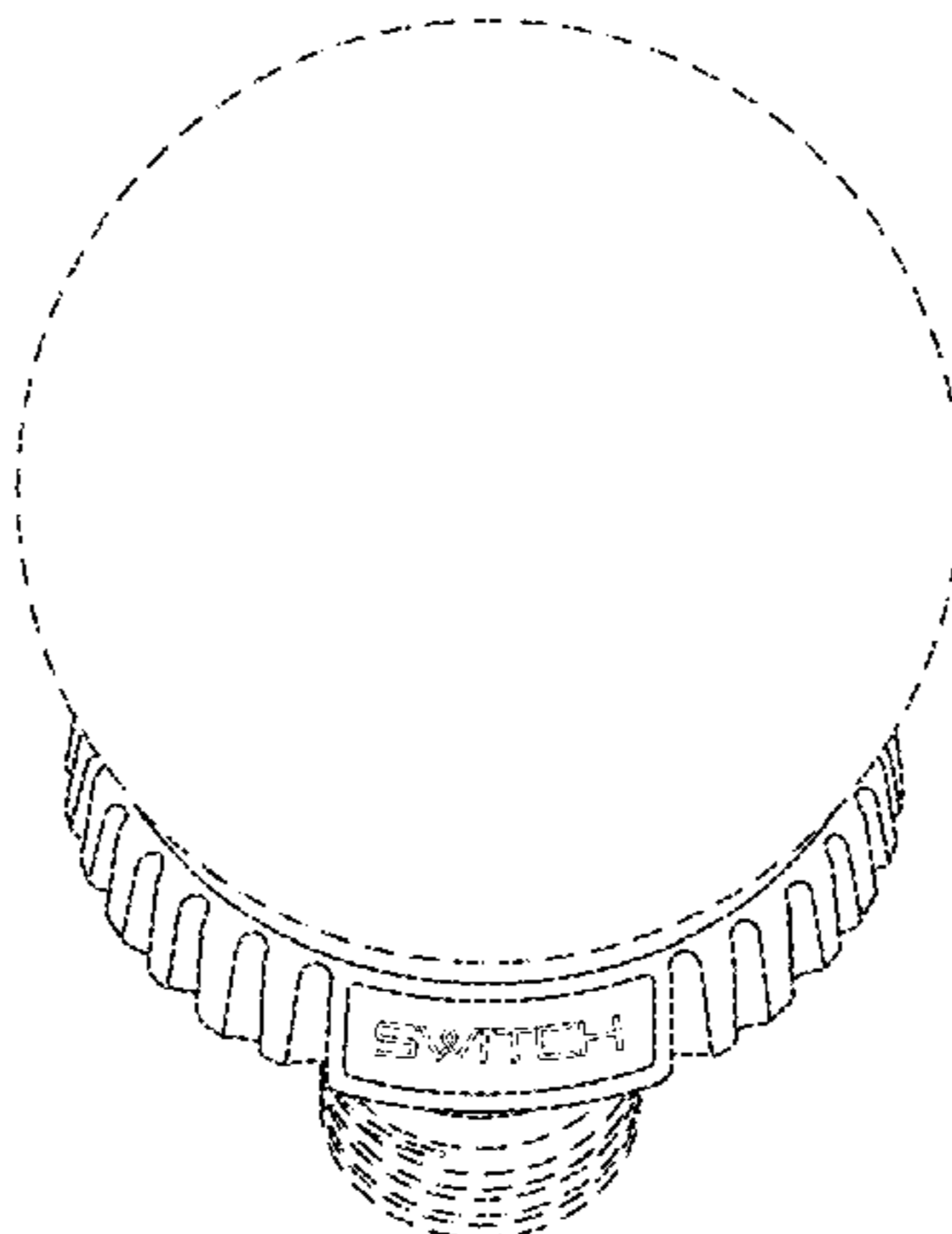

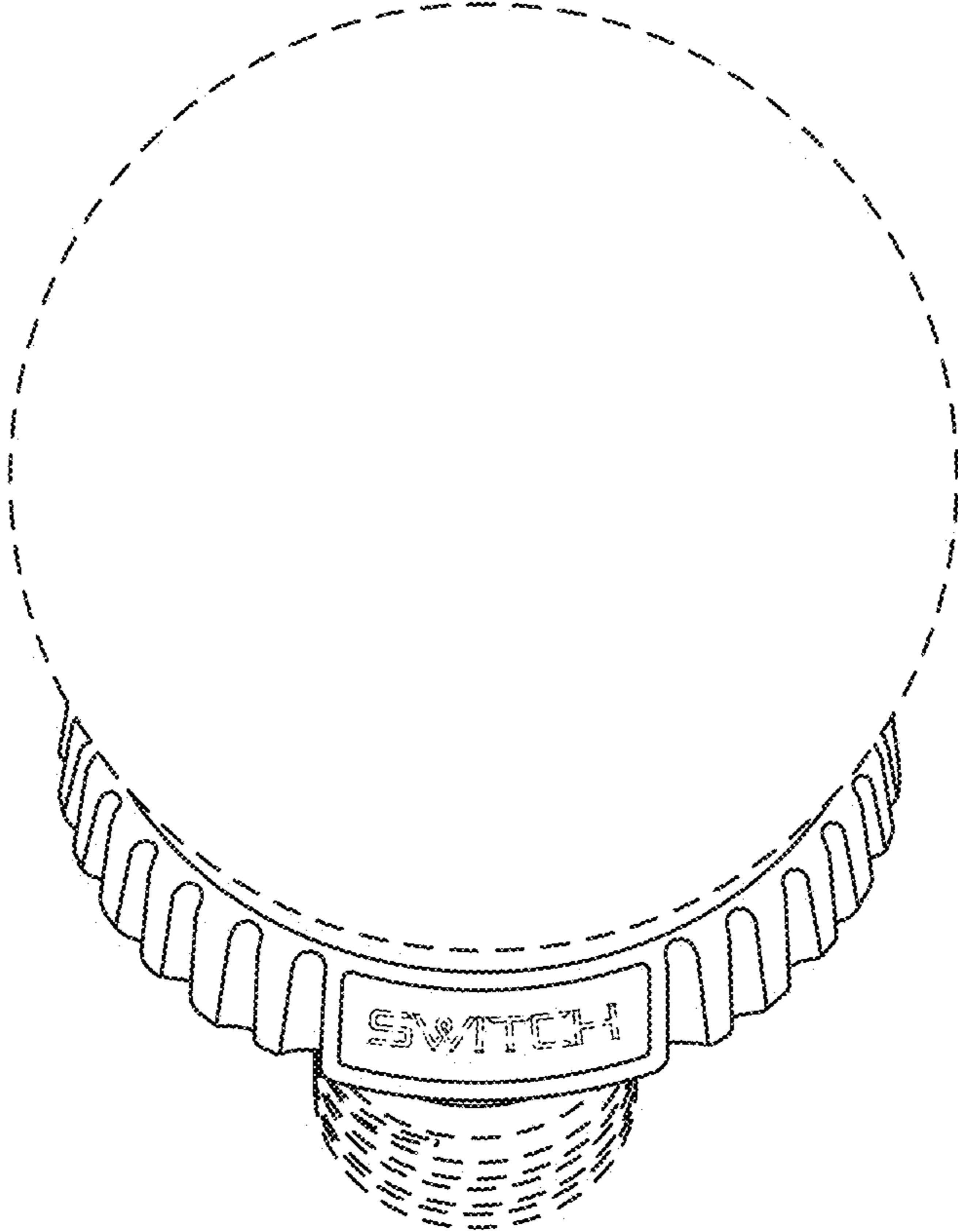

FIG. 1

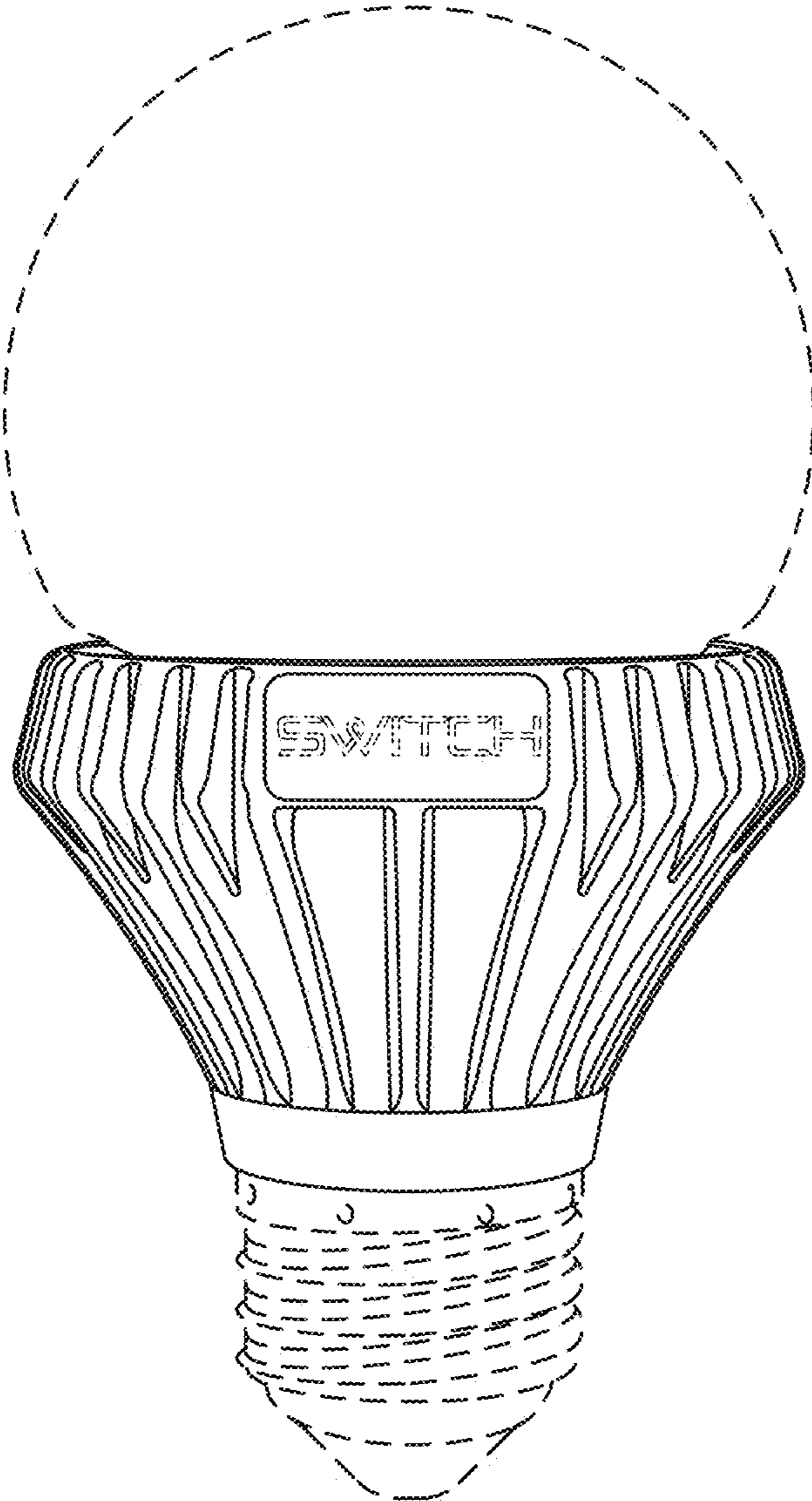

FIG. 2

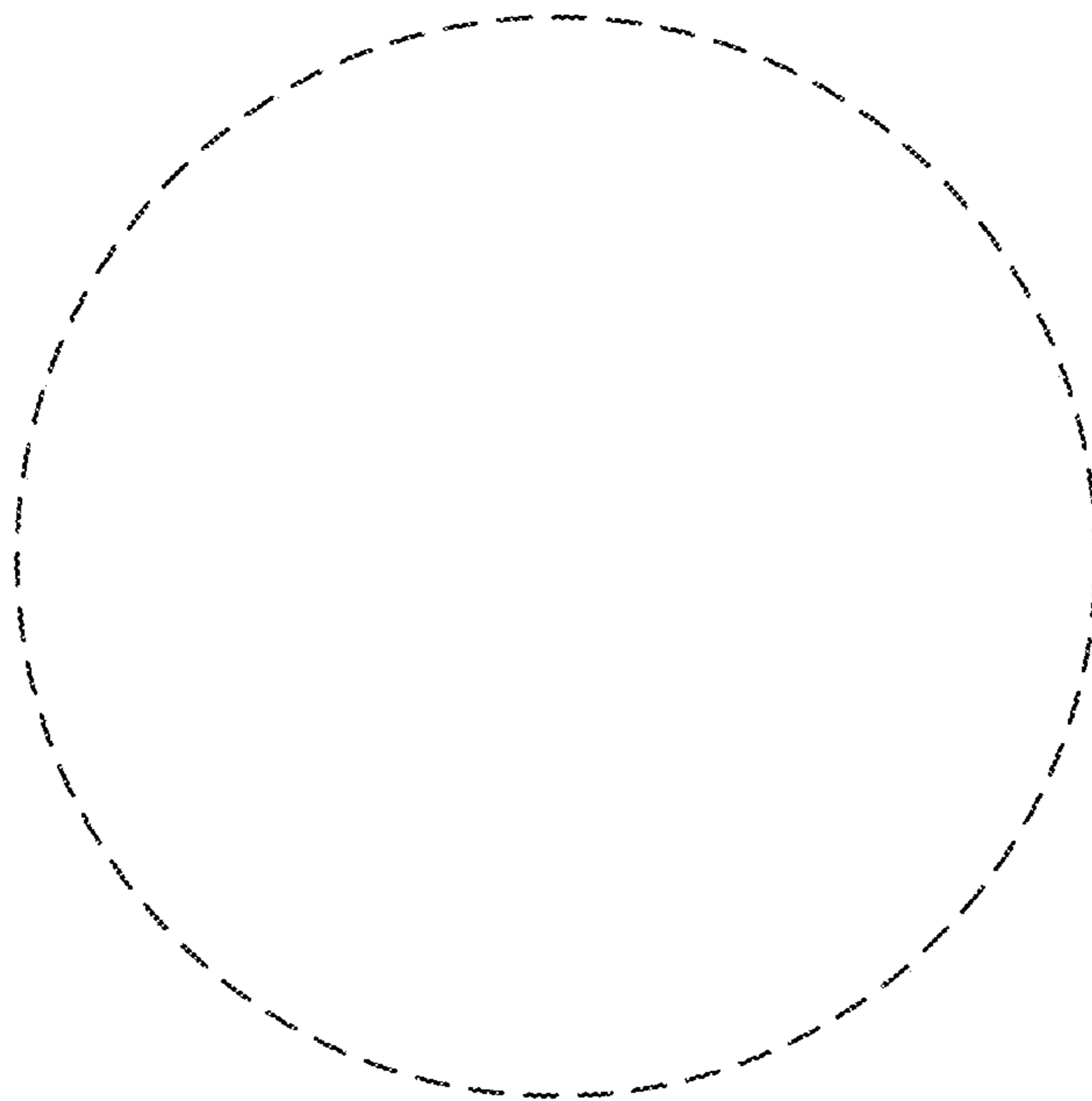

FIG. 3

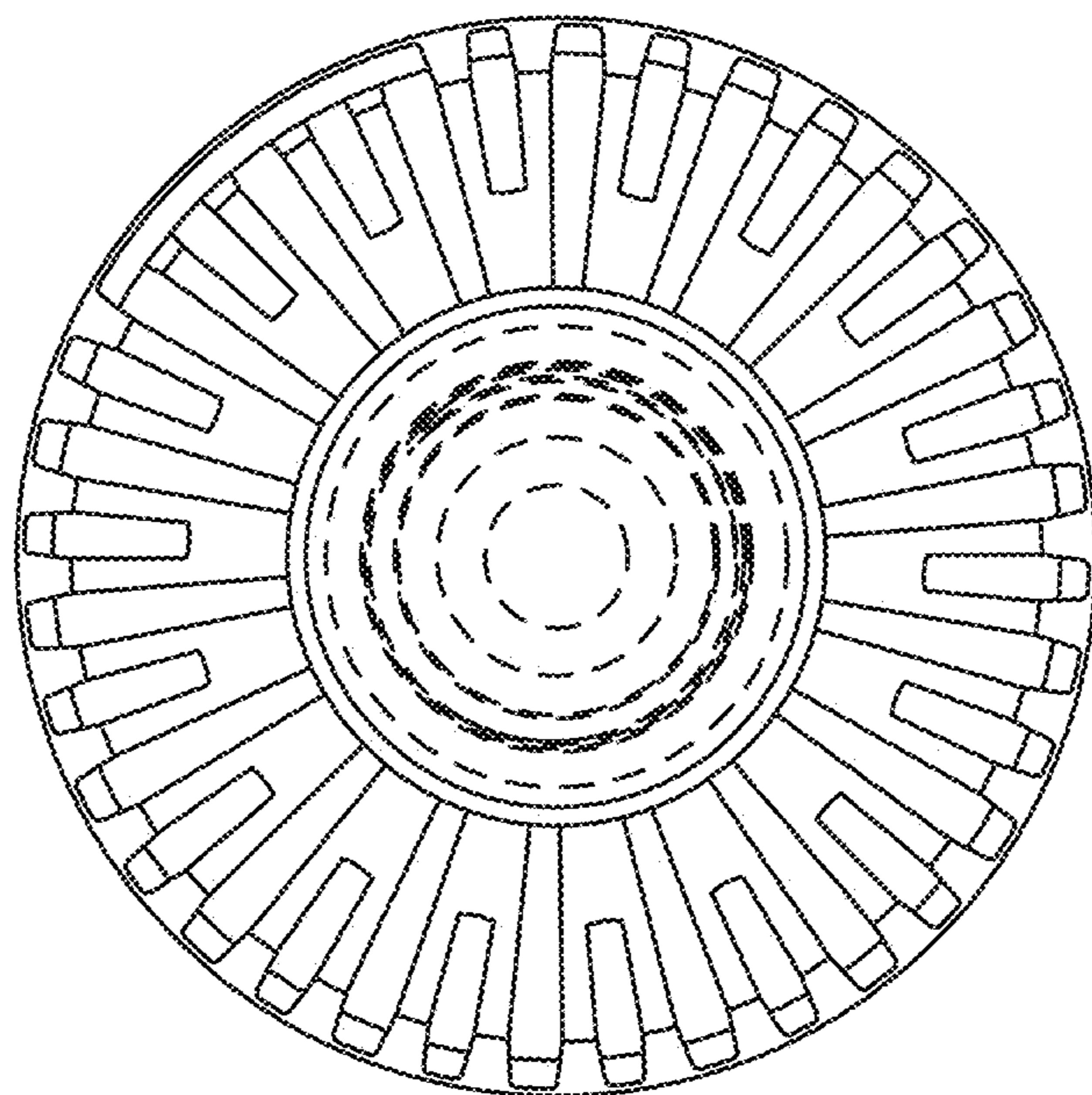

FIG. 4

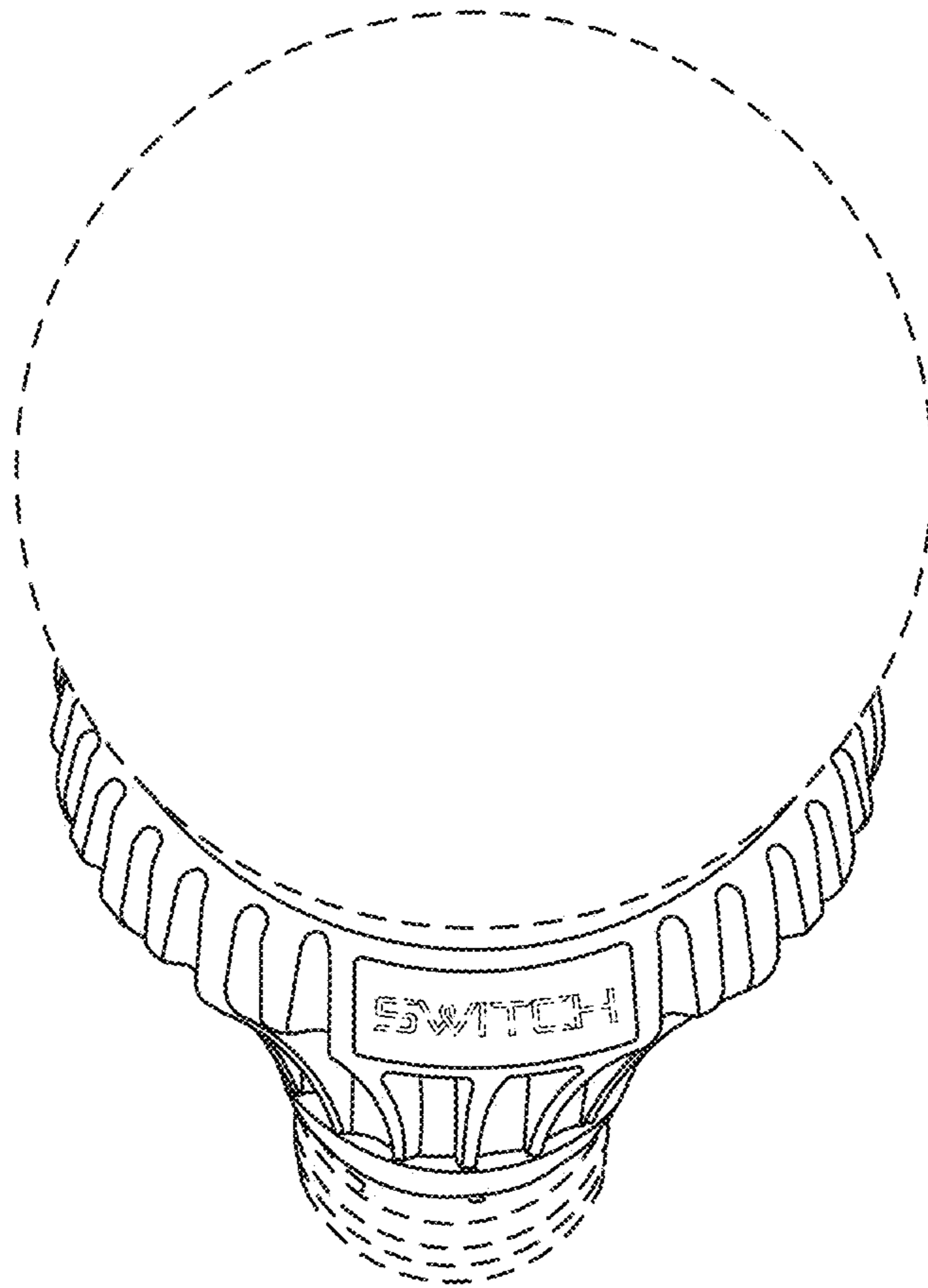

FIG. 5

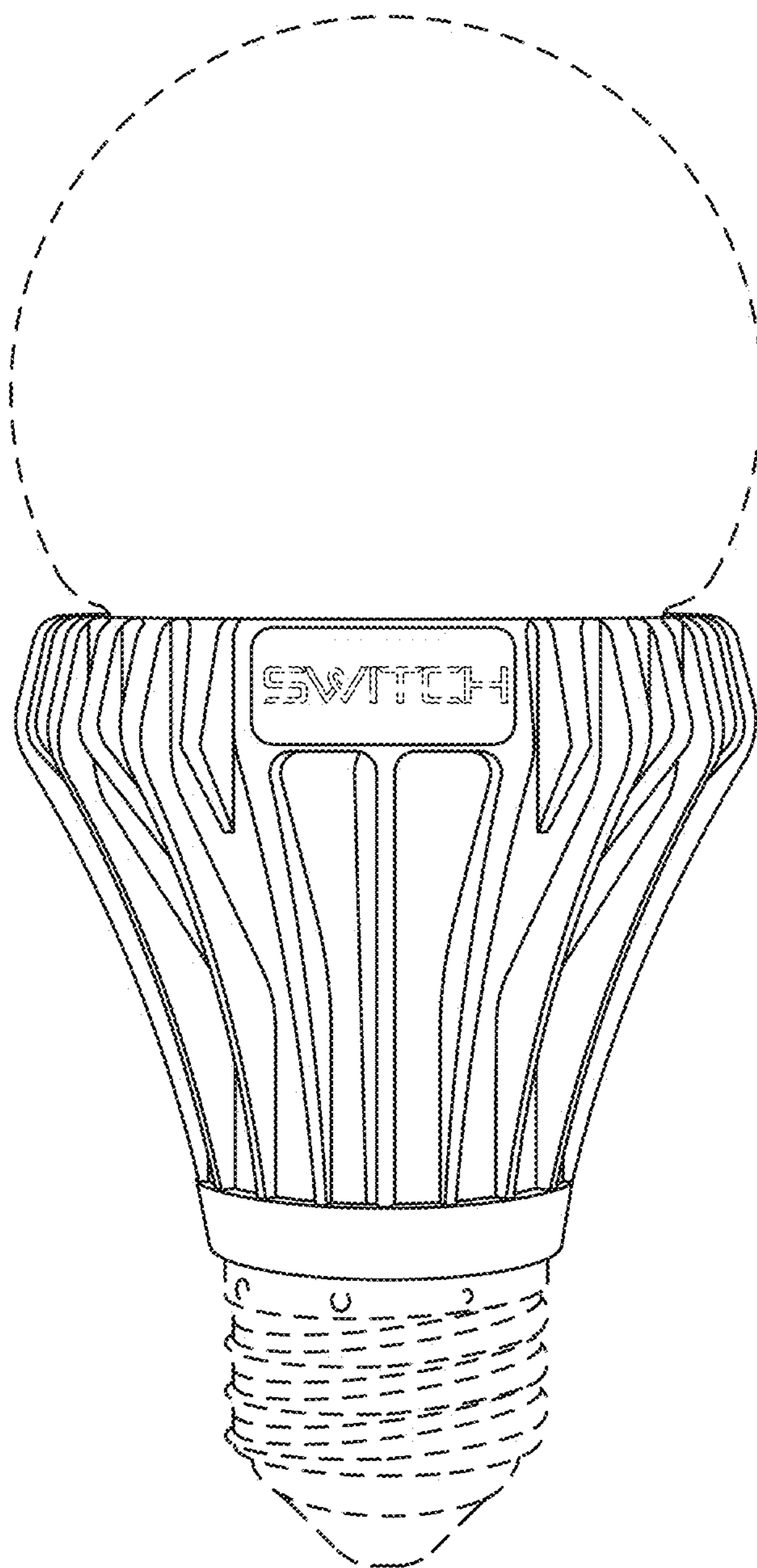

FIG. 6

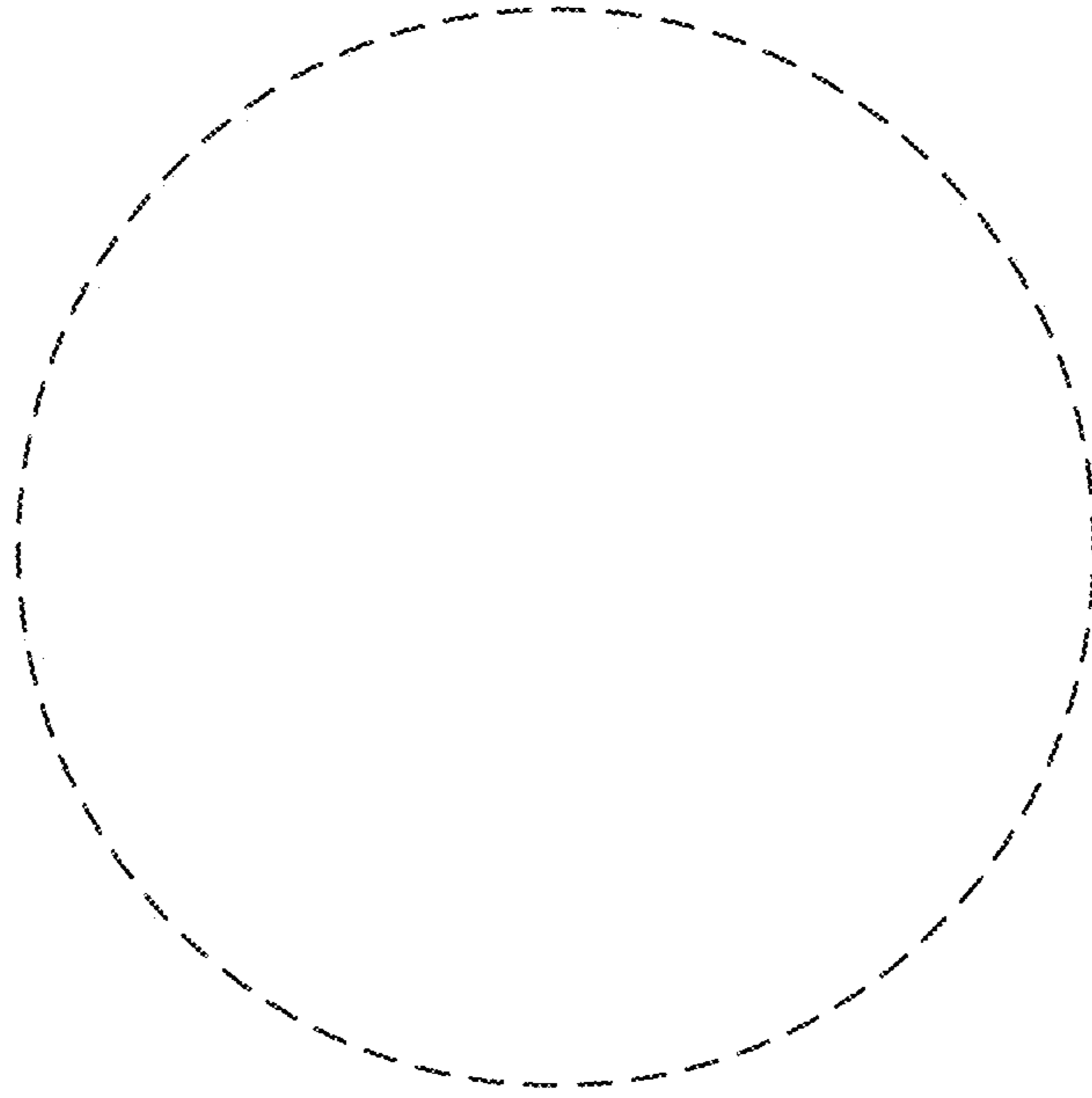

FIG. 7

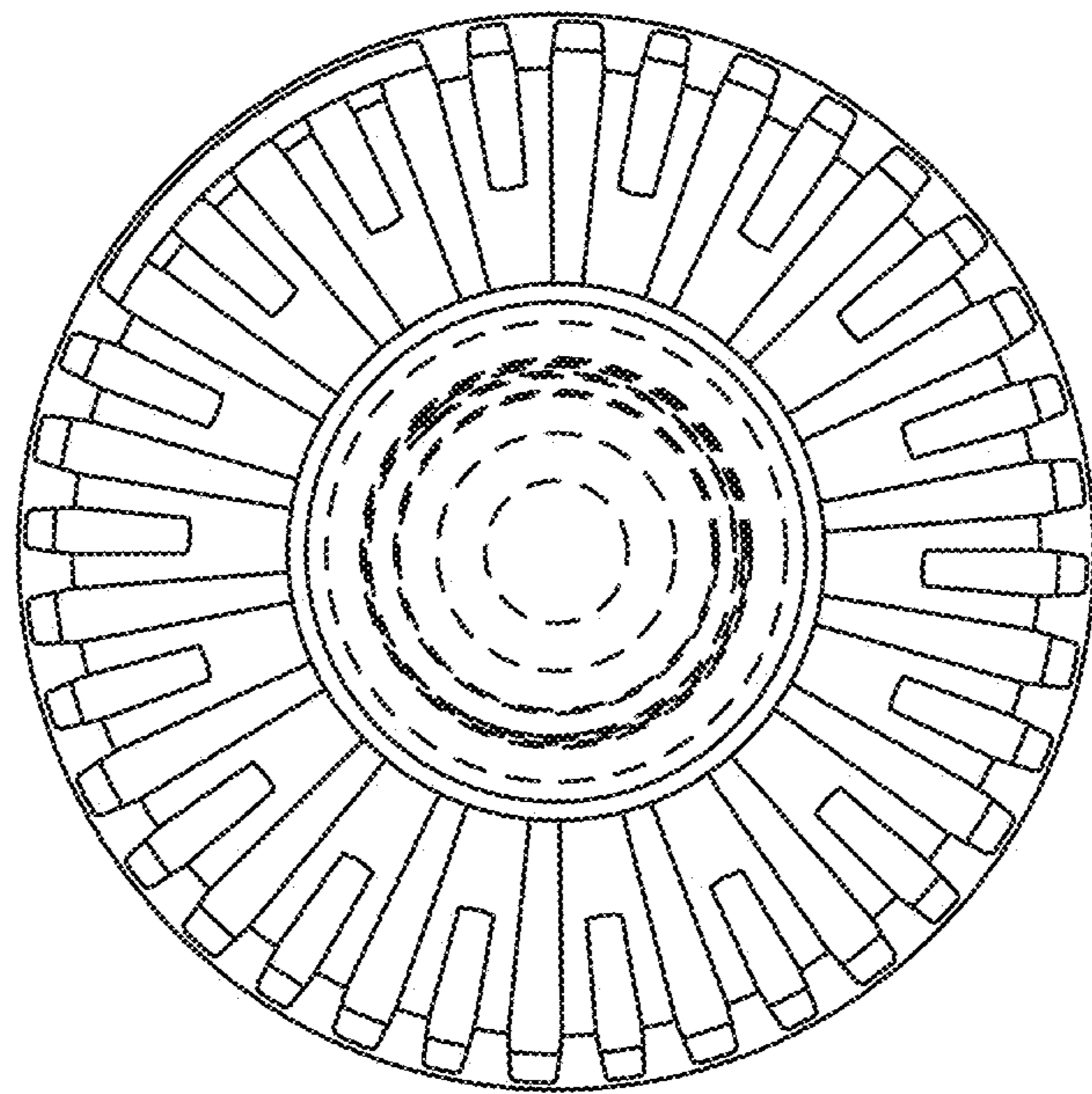

FIG. 8

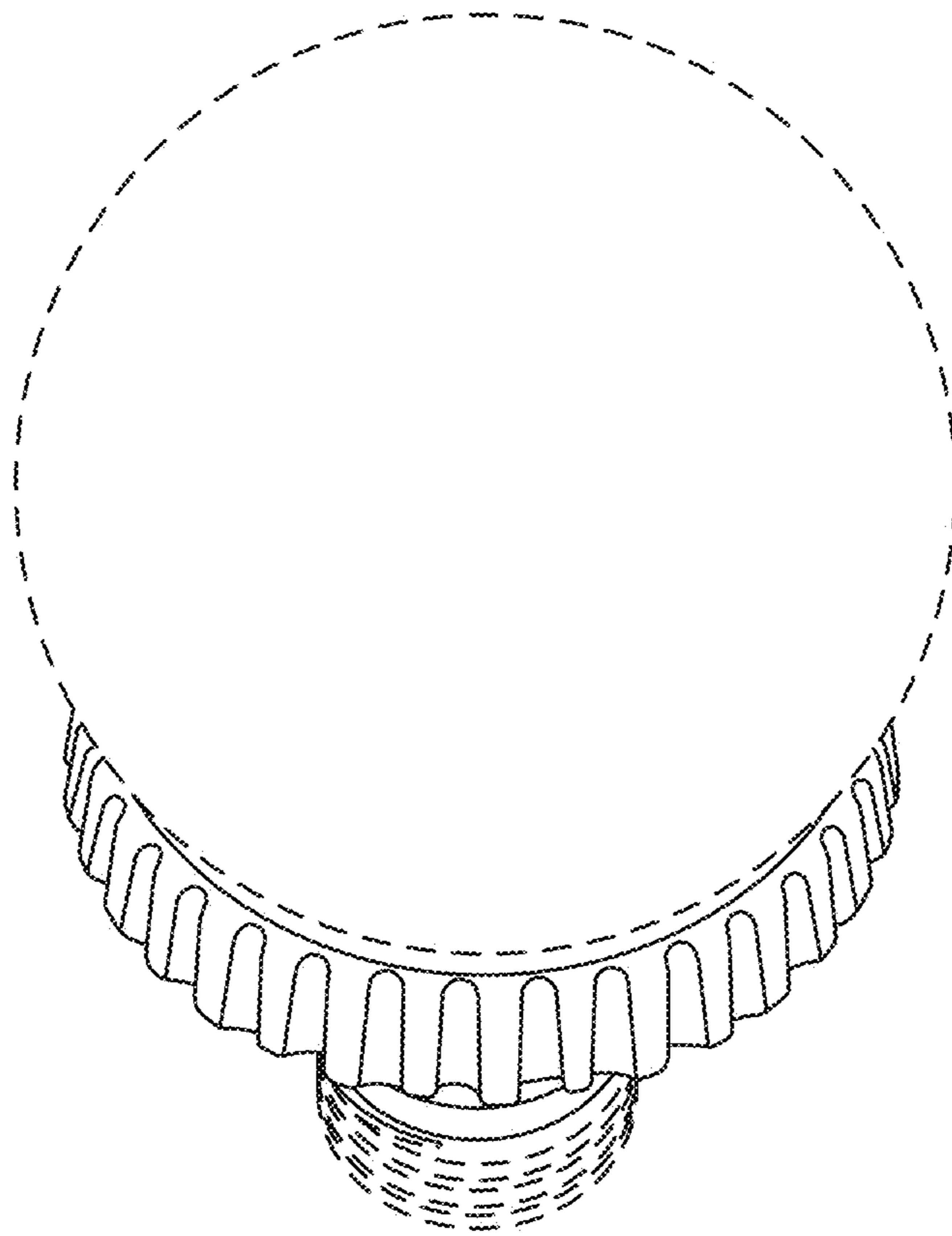

FIG. 9

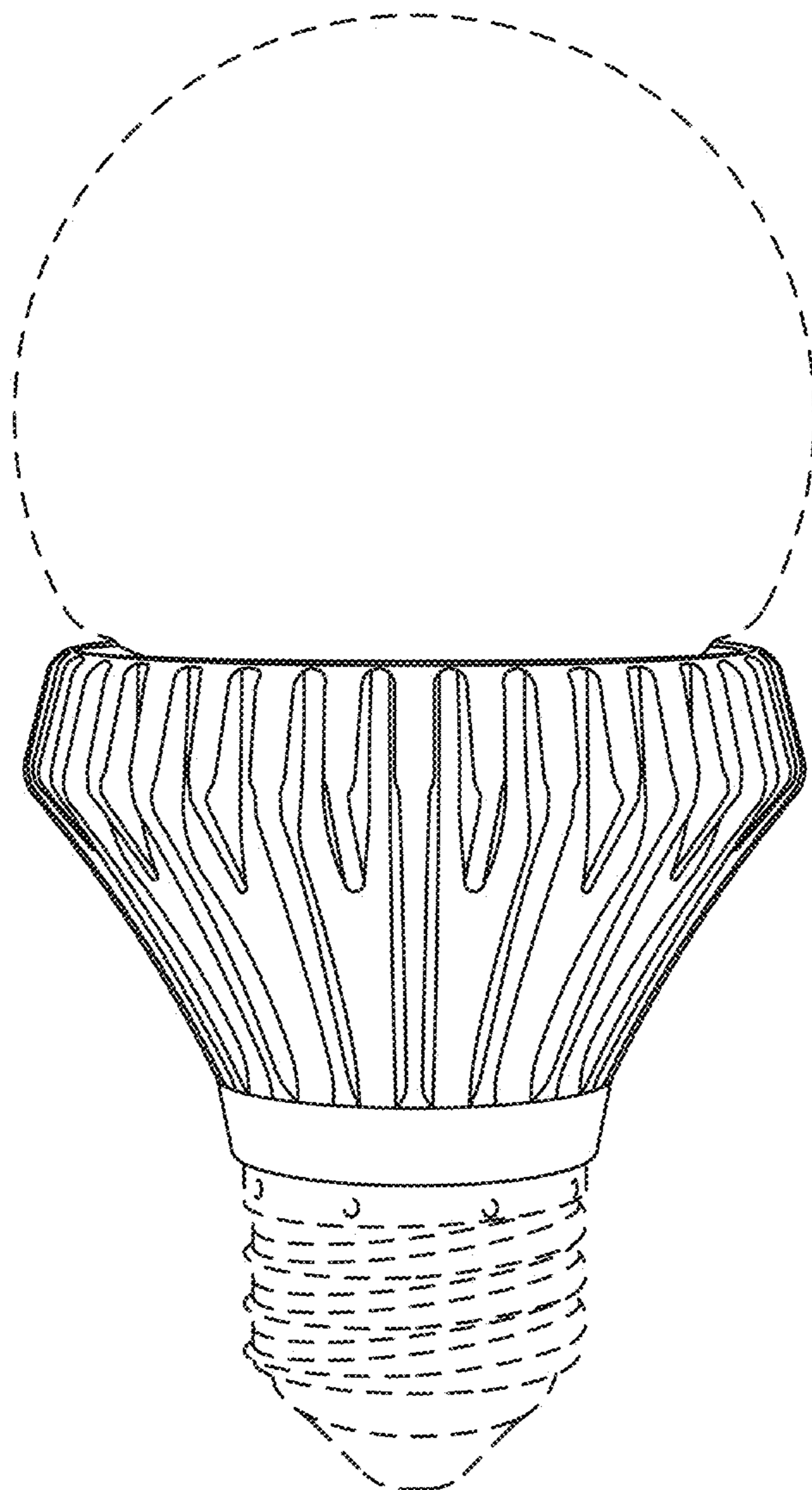

FIG. 10

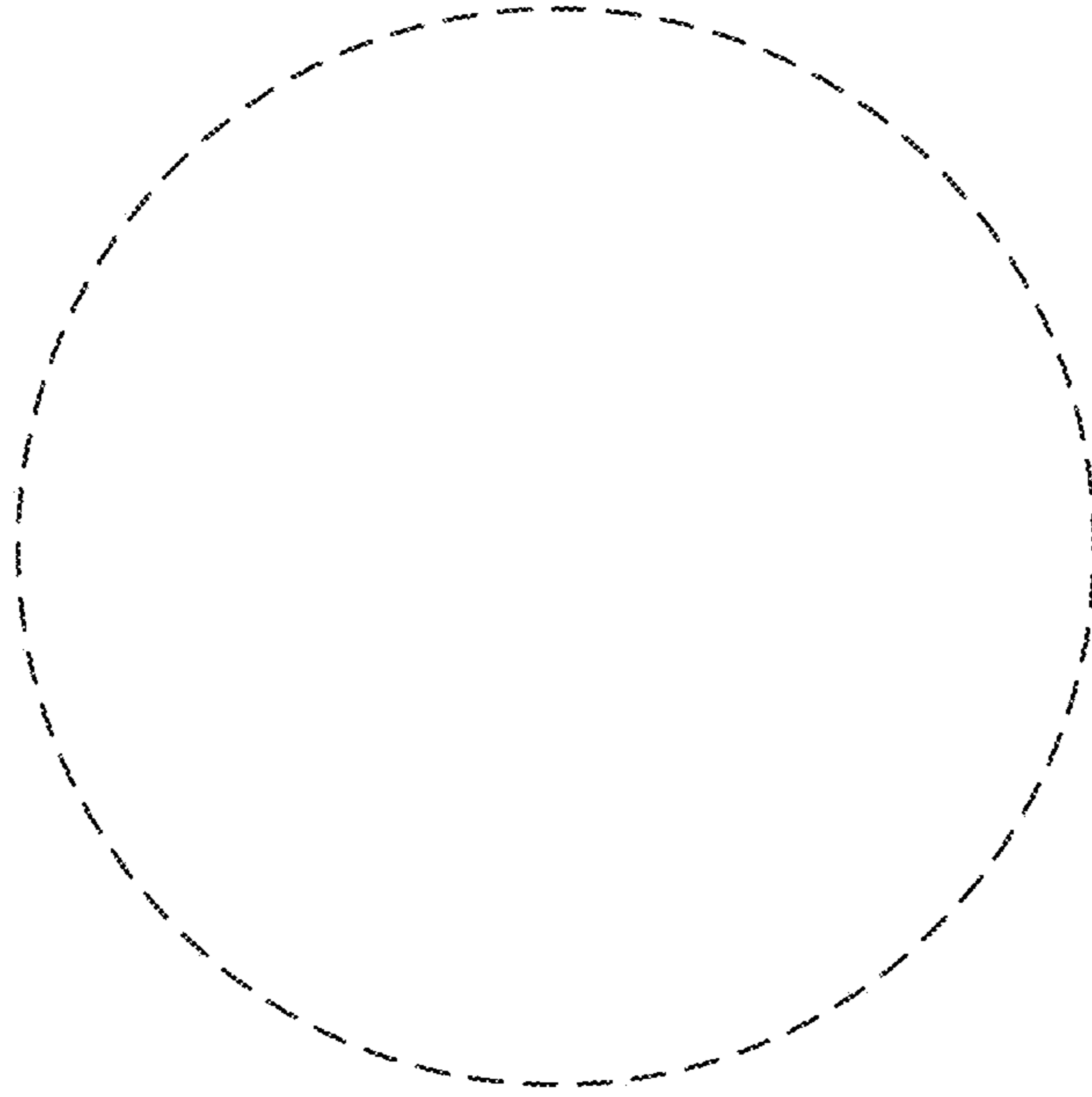

FIG. 11

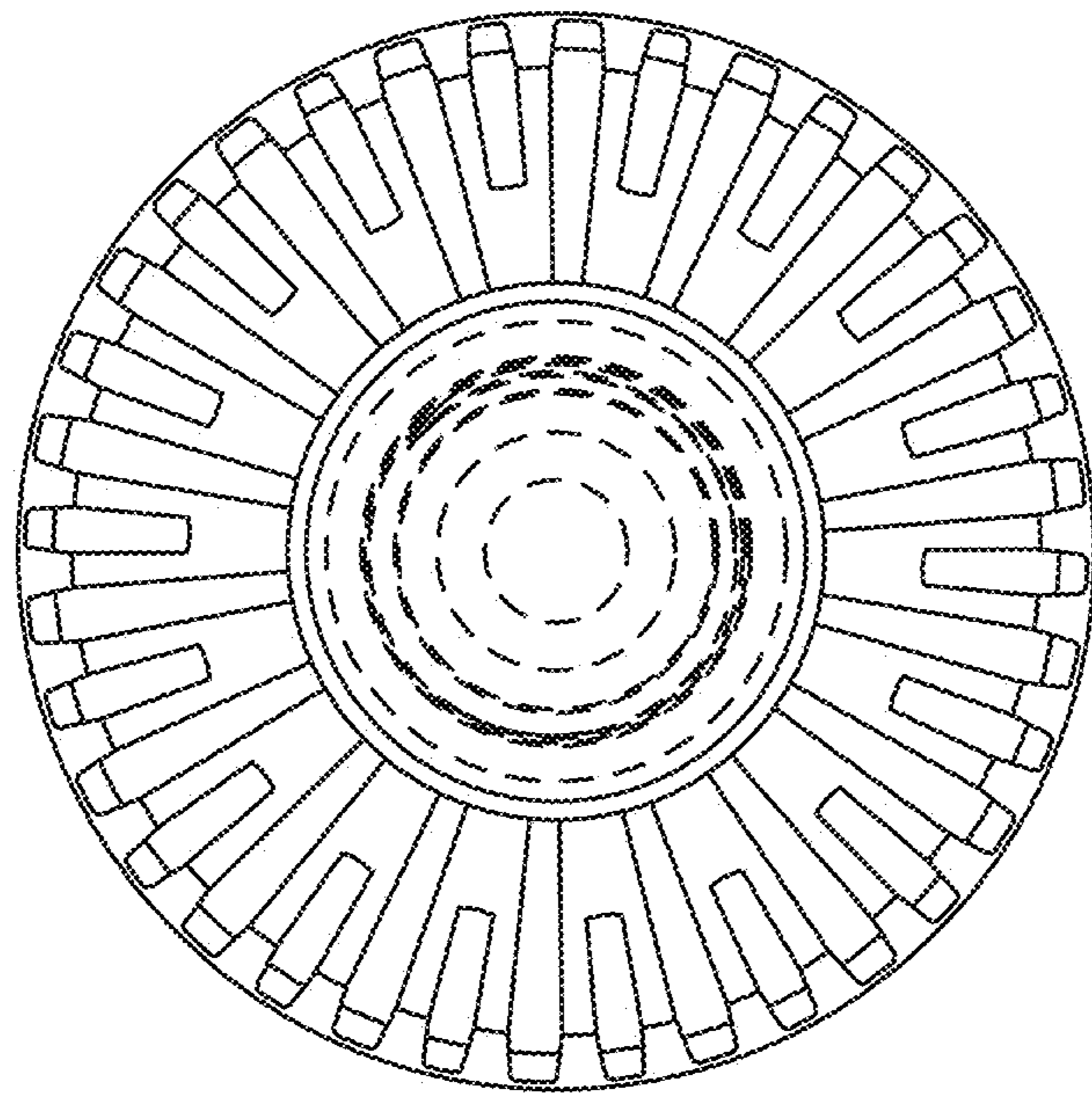

FIG. 12

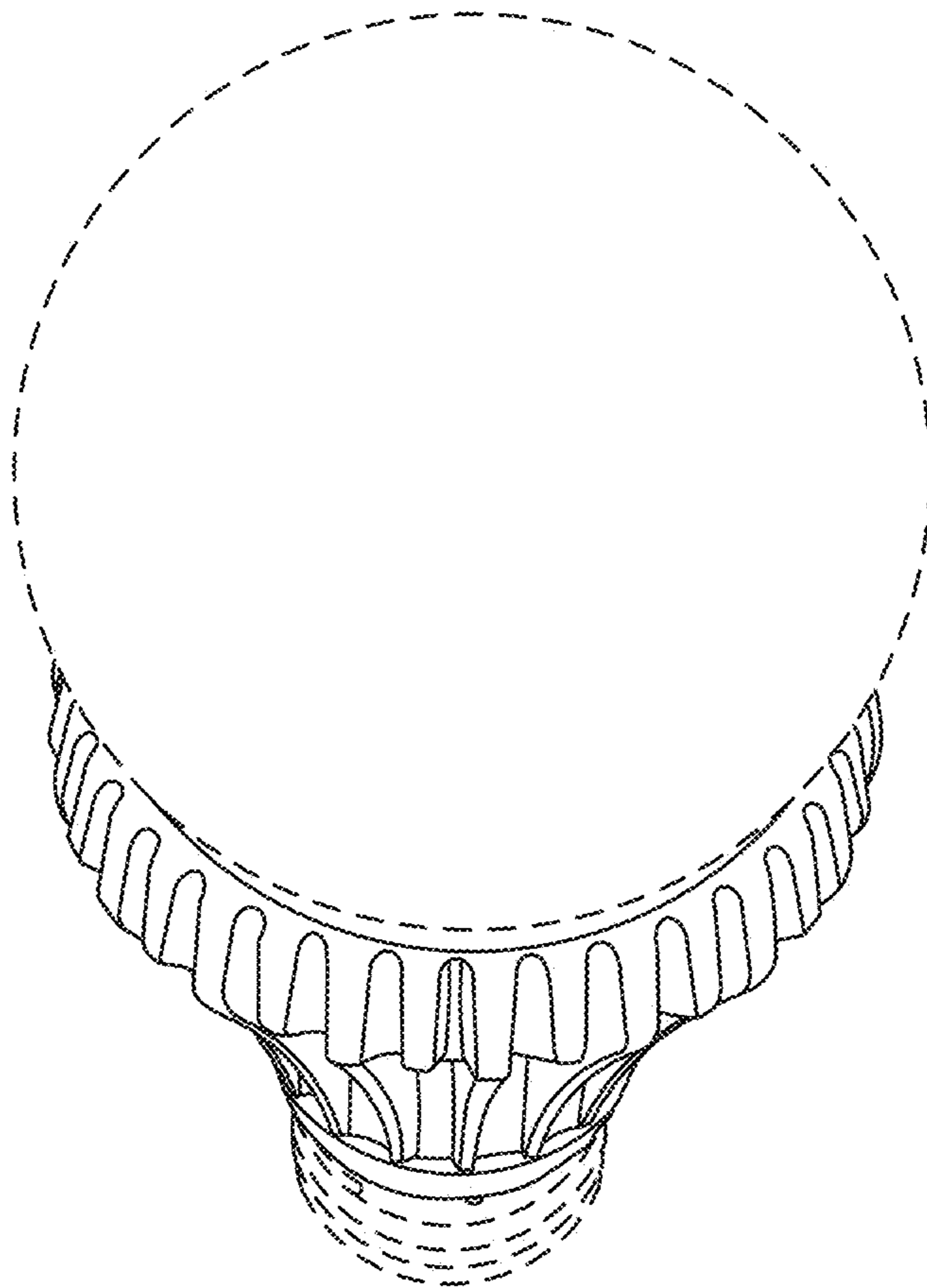

FIG. 13

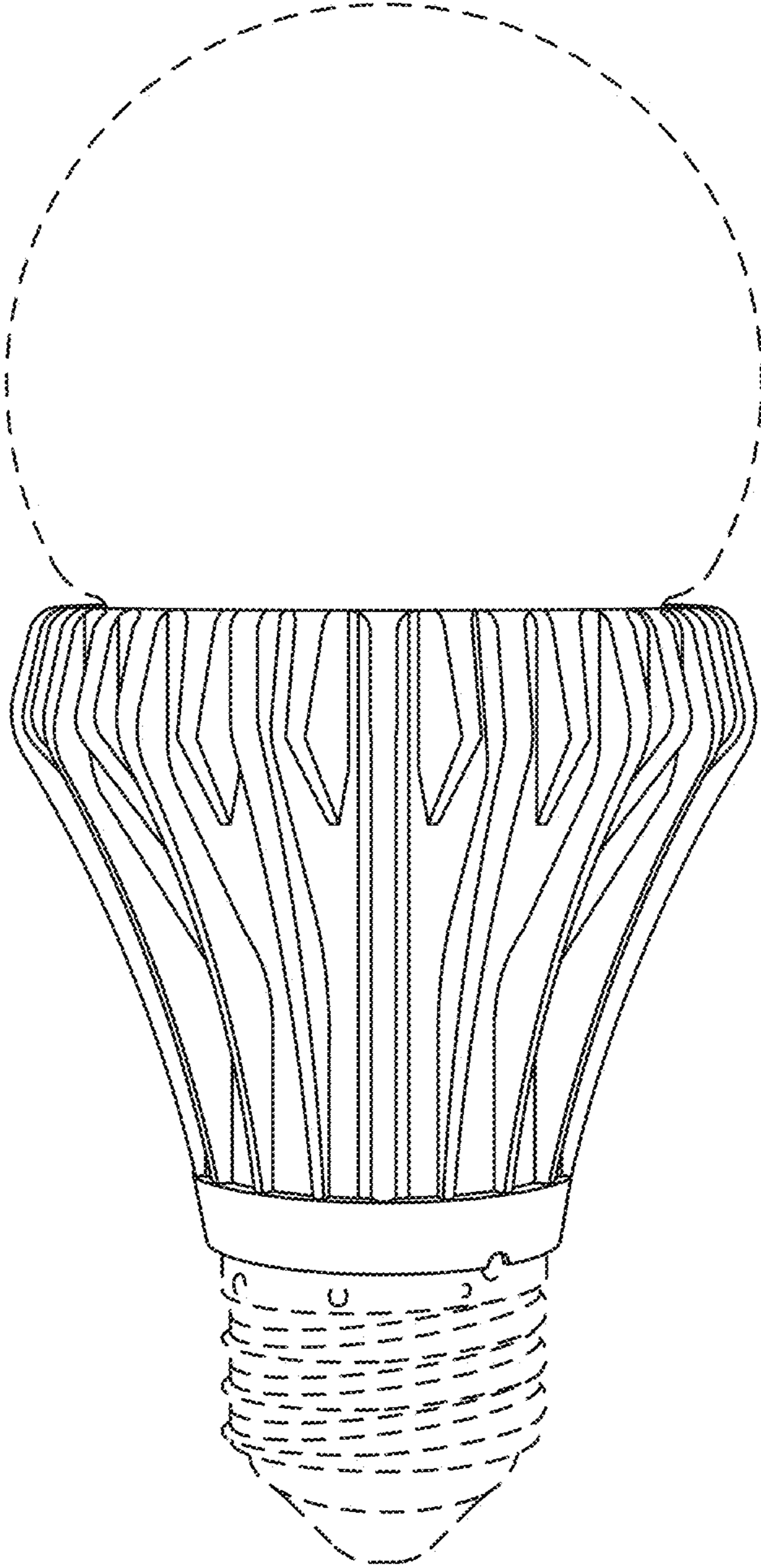

FIG. 14

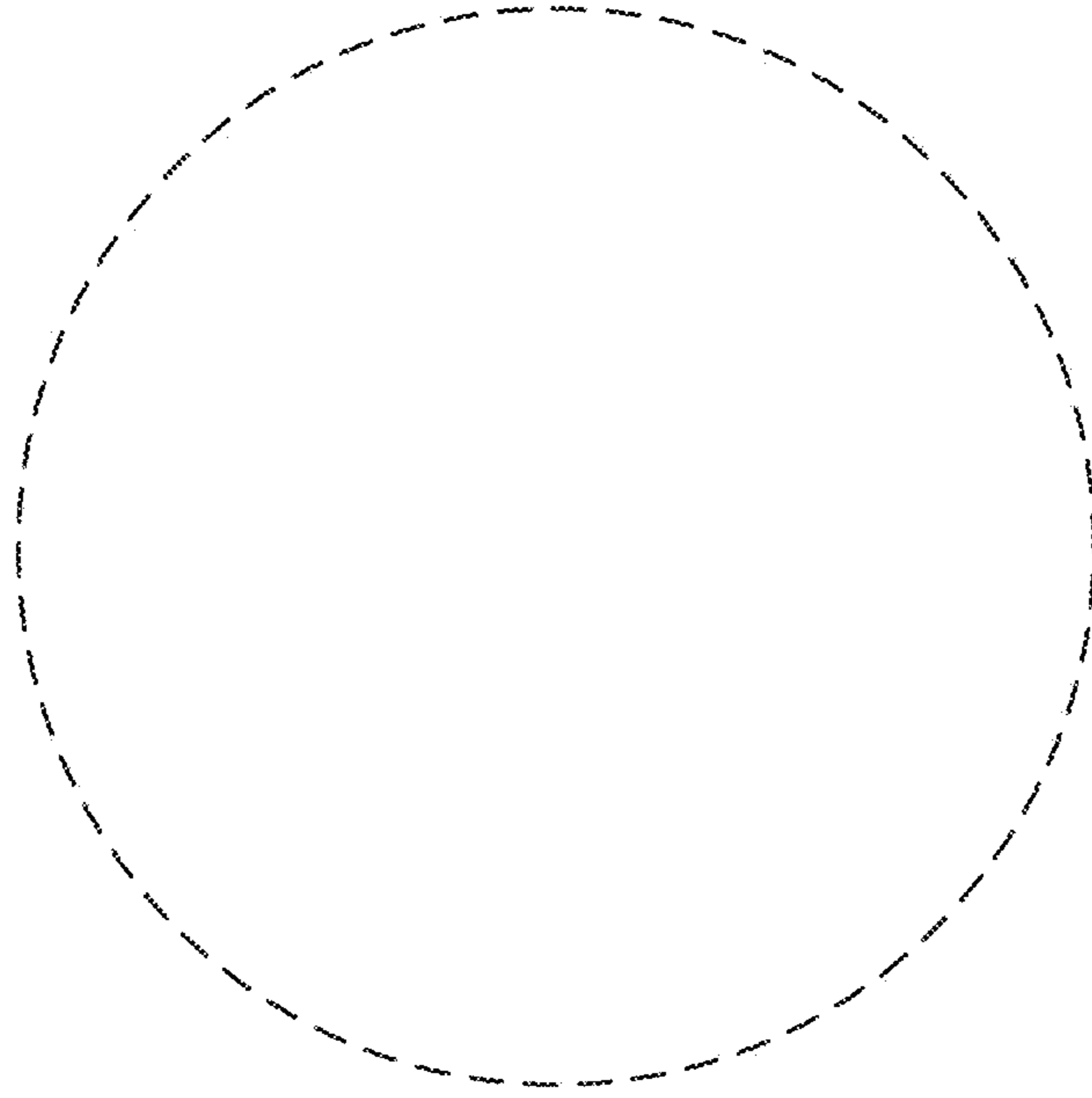

FIG. 15

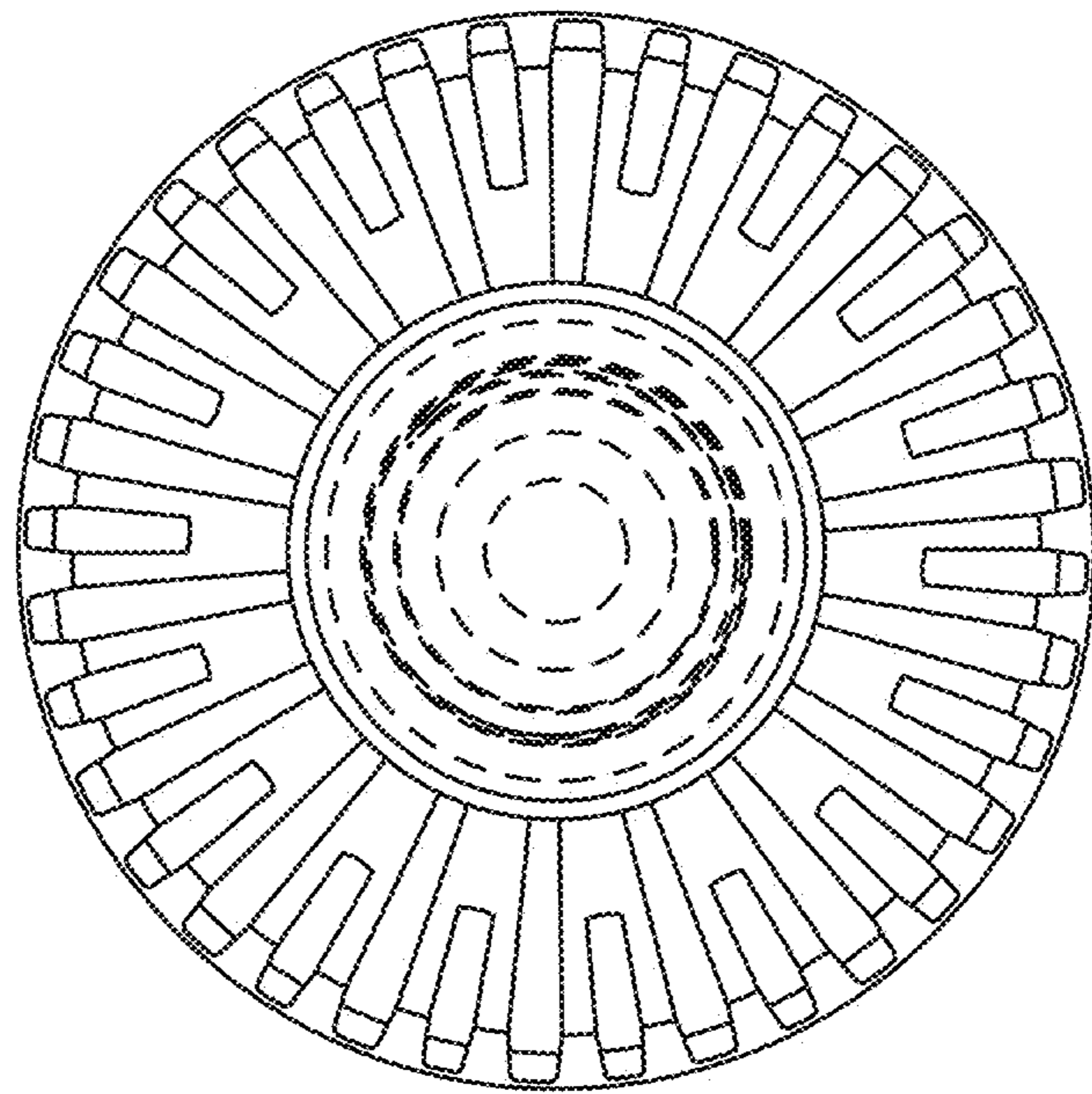

FIG. 16