



US00D706425S

(12) **United States Design Patent**
Morelli

(10) **Patent No.:** **US D706,425 S**
(45) **Date of Patent:** **** Jun. 3, 2014**

(54) **ORTHODONTIC DEVICE**

(71) Applicant: **Dental Morelli Ltda., Sorocaba/SP (BR)**

(72) Inventor: **Oraci João de Vecchi Morelli,**
Sorocaba/SP (BR)

(73) Assignee: **Dental Morelli Ltda., Sorocaba/SP (BR)**

(**) Term: **14 Years**

(21) Appl. No.: **29/447,753**

(22) Filed: **Mar. 6, 2013**

(30) **Foreign Application Priority Data**

Sep. 6, 2012 (BR) 3020120045894

(51) **LOC (10) Cl.** **24-99**

(52) **U.S. Cl.**
USPC **D24/180**

(58) **Field of Classification Search**
USPC D24/155-156, 176, 180; 433/2, 6-24,
433/140

See application file for complete search history.

(56) **References Cited**

U.S. PATENT DOCUMENTS

D339,421	S *	9/1993	Schultz	D24/180
D367,116	S *	2/1996	Viazis	D24/180
6,257,883	B1 *	7/2001	Voudouris	433/11
6,368,105	B1 *	4/2002	Voudouris et al.	433/11
6,776,613	B2 *	8/2004	Orikasa	433/11
7,234,935	B2 *	6/2007	Abels et al.	433/8
7,335,020	B2 *	2/2008	Castner et al.	433/11
7,442,039	B2 *	10/2008	Opin et al.	433/11

8,469,704	B2 *	6/2013	Oda et al.	433/11
2007/0160949	A1 *	7/2007	Voudouris	433/8
2009/0061376	A1 *	3/2009	Wool	433/11
2009/0291404	A1 *	11/2009	Oda	433/11
2009/0298003	A1 *	12/2009	Wei et al.	433/9
2012/0135364	A1 *	5/2012	Tuneberg et al.	433/9
2012/0237887	A1 *	9/2012	Mashouf	433/10
2013/0236847	A1 *	9/2013	Shin	433/3
2014/0023981	A1 *	1/2014	Voudouris	433/9

* cited by examiner

Primary Examiner — Wan Laymon

(74) *Attorney, Agent, or Firm* — Nilay J. Choksi; Smith & Hopen, P.A.

(57) **CLAIM**

The ornamental design for a orthodontic device, as substantially shown and described.

DESCRIPTION

FIG. 1 is a front view of a orthodontic device in accordance with the present design;
FIG. 2 is a back view thereof;
FIG. 3 is a left side view thereof;
FIG. 4 is a right side view thereof;
FIG. 5 is an upper view thereof;
FIG. 6 is a bottom view thereof;
FIG. 7 is a perspective view thereof;
FIG. 8 is a perspective view thereof;
FIG. 9 is a perspective view thereof;
FIG. 10 is a perspective view thereof;
FIG. 11 is a perspective view thereof; and,
FIG. 12 is a perspective view thereof.

1 Claim, 4 Drawing Sheets

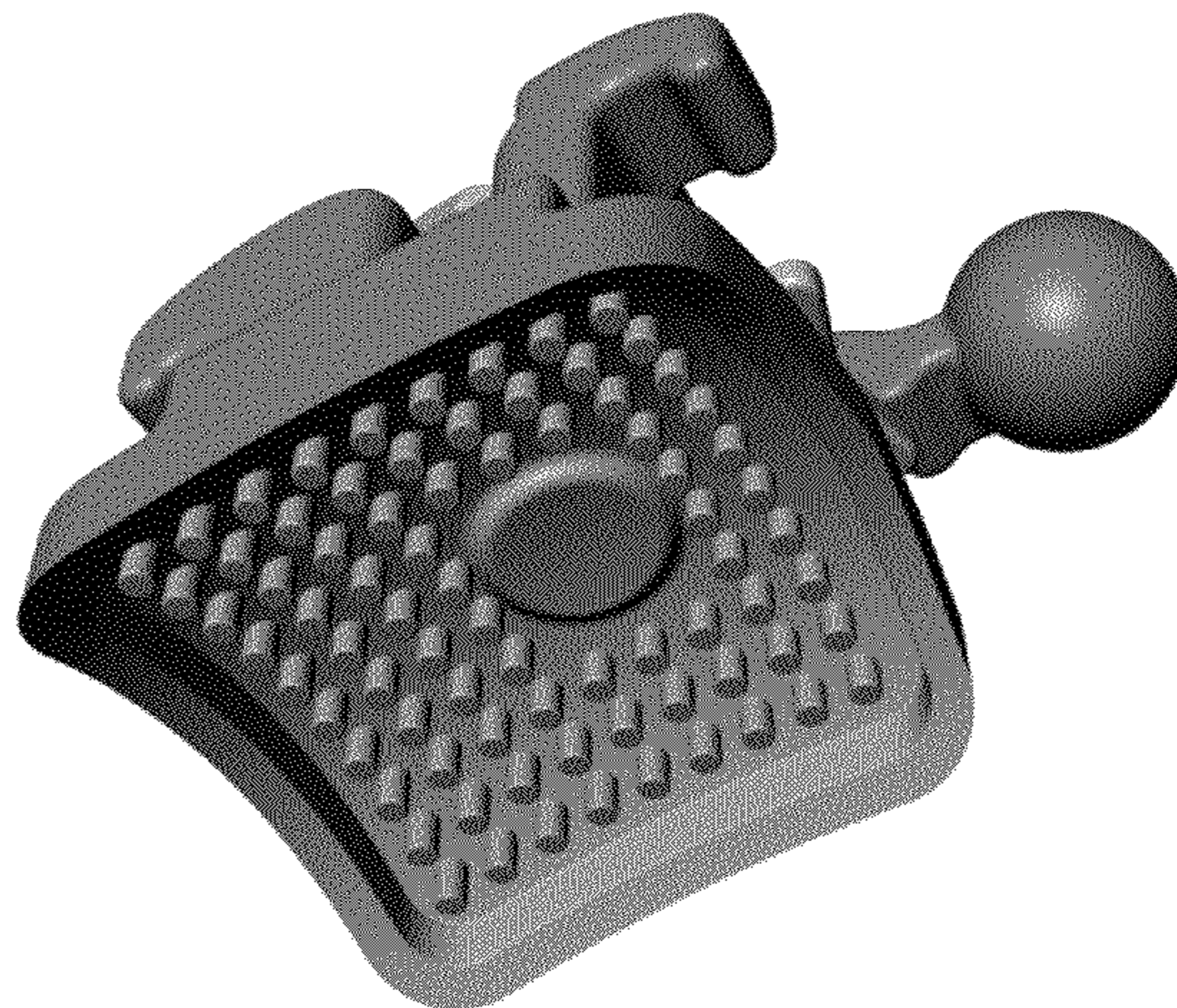
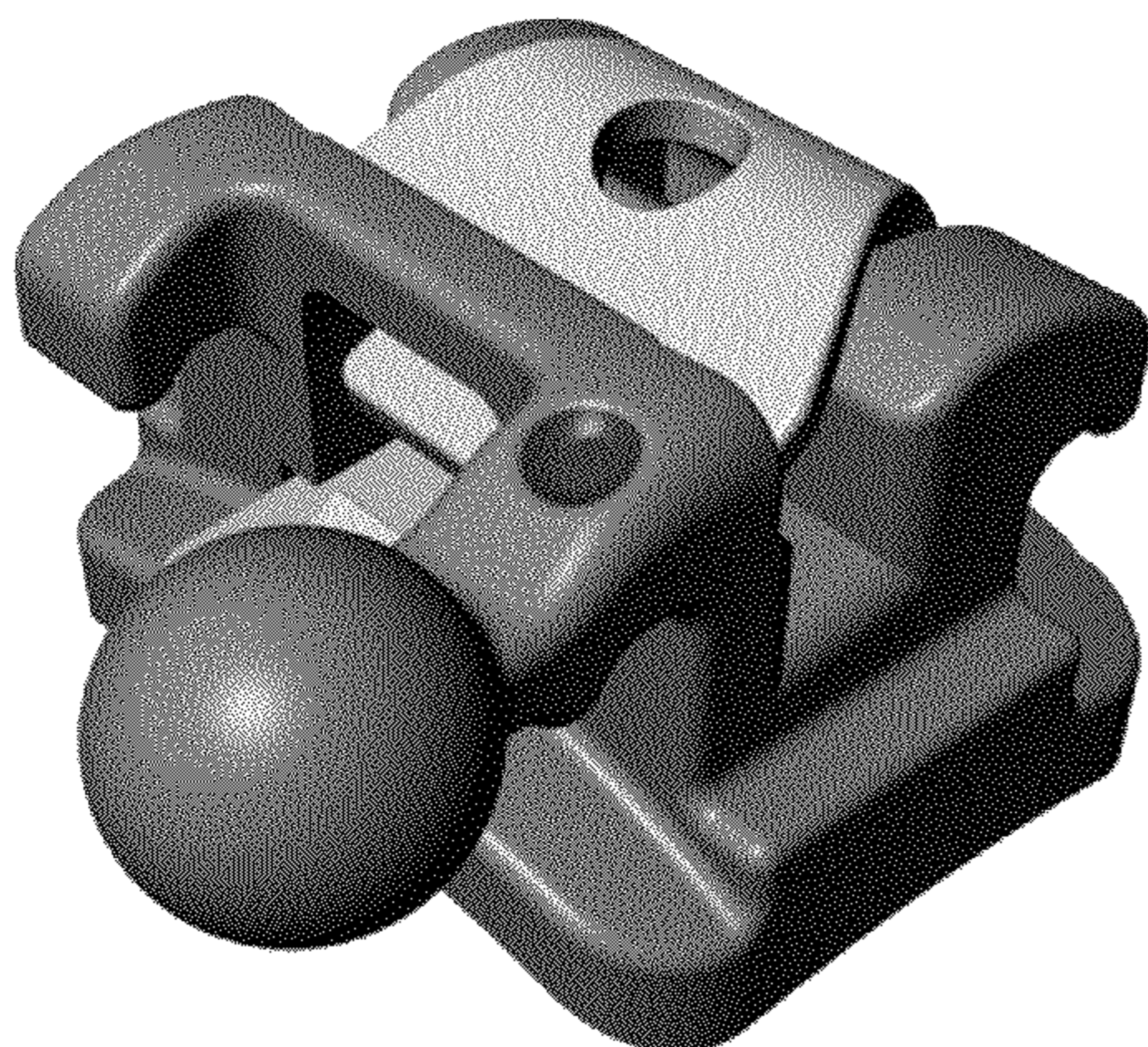

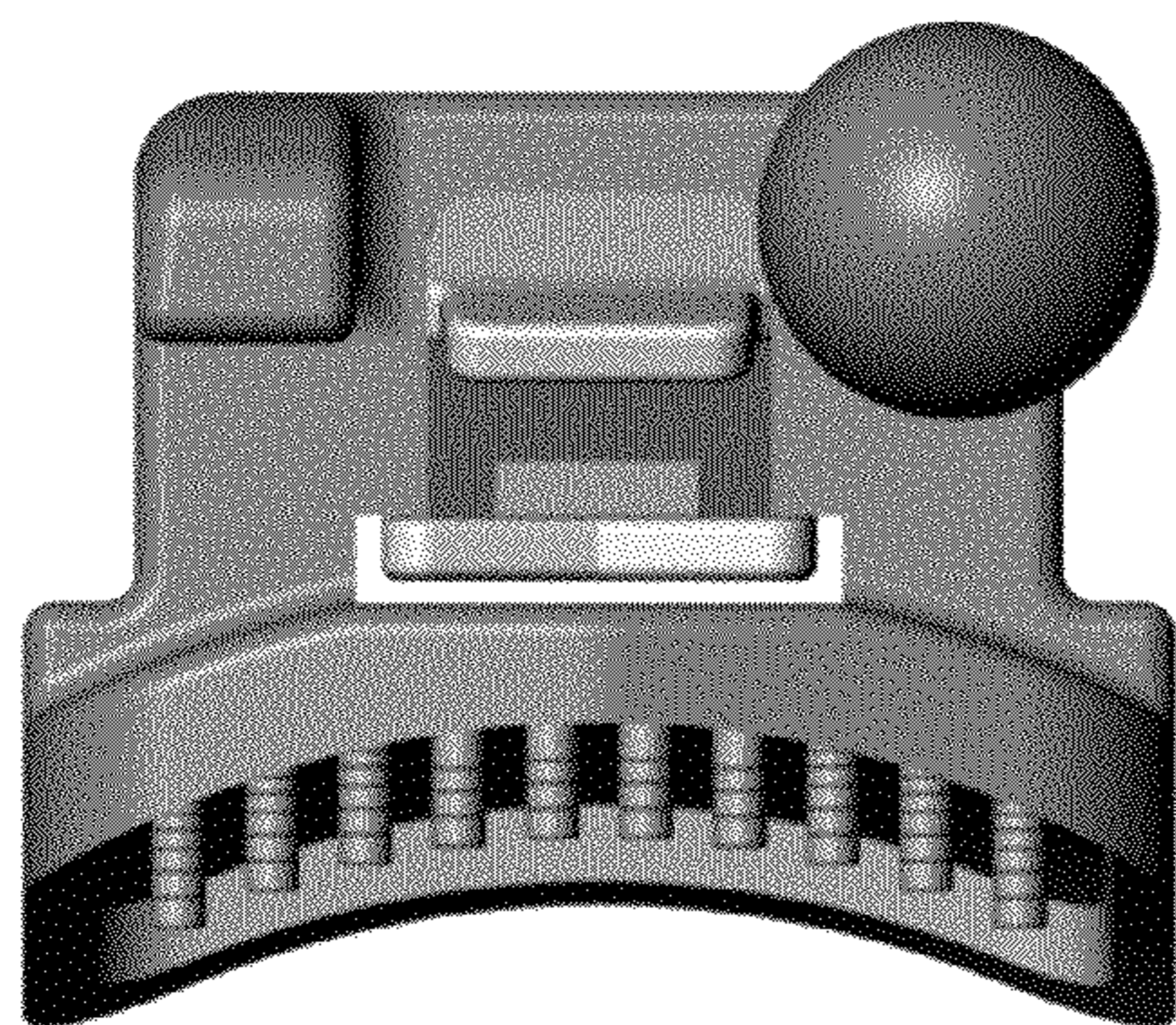

FIG. 1

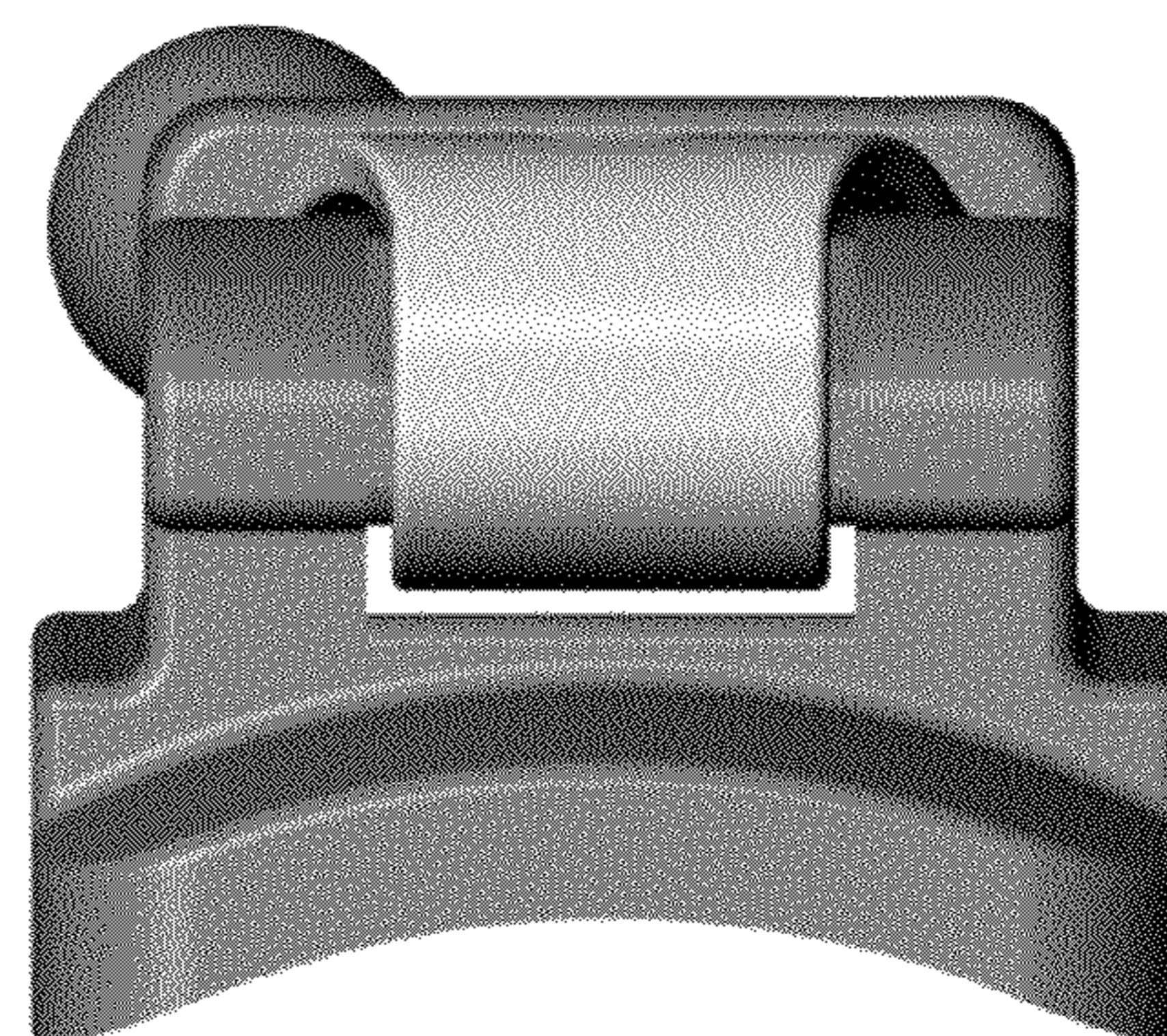

FIG. 2

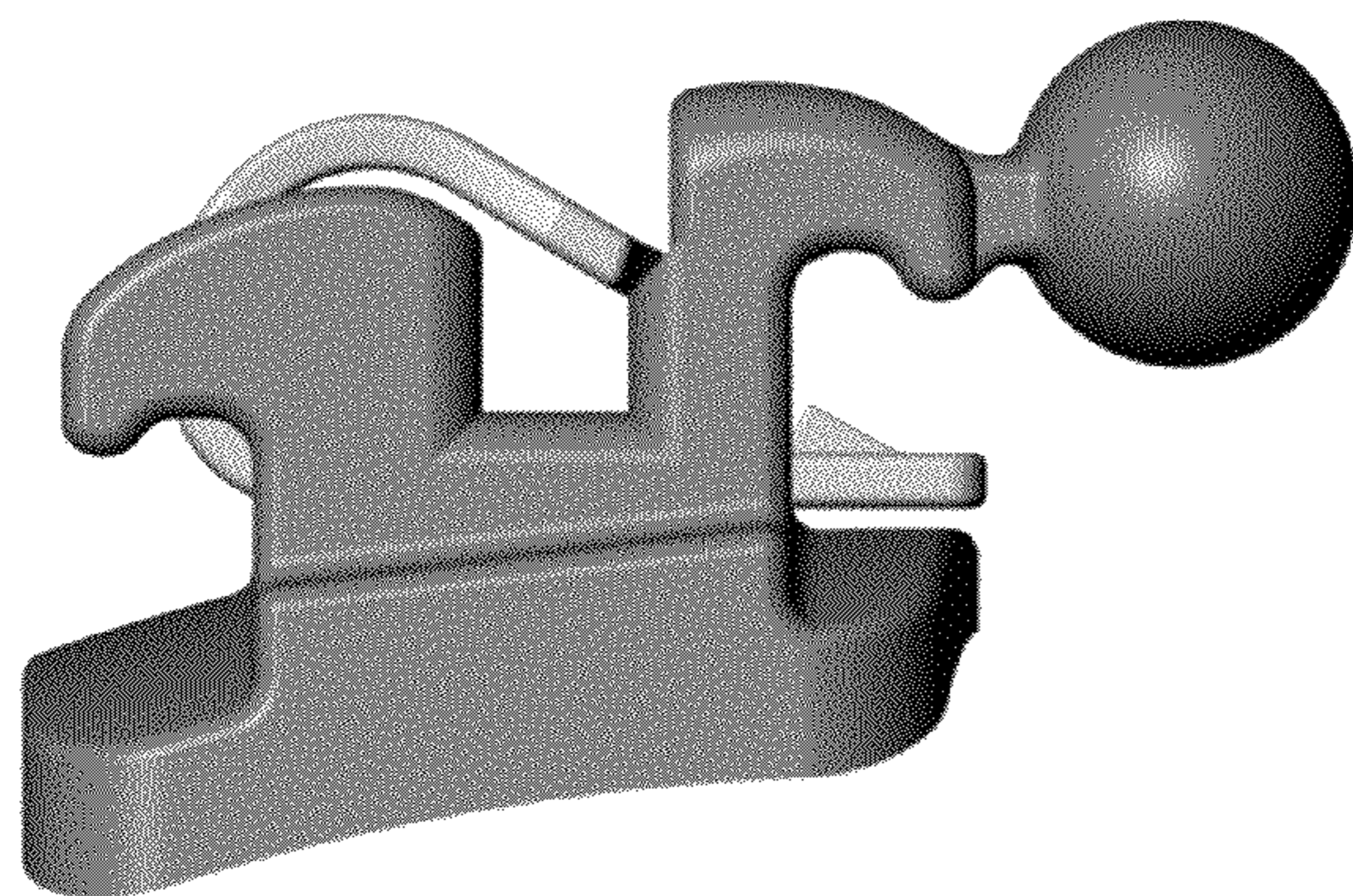

FIG. 3

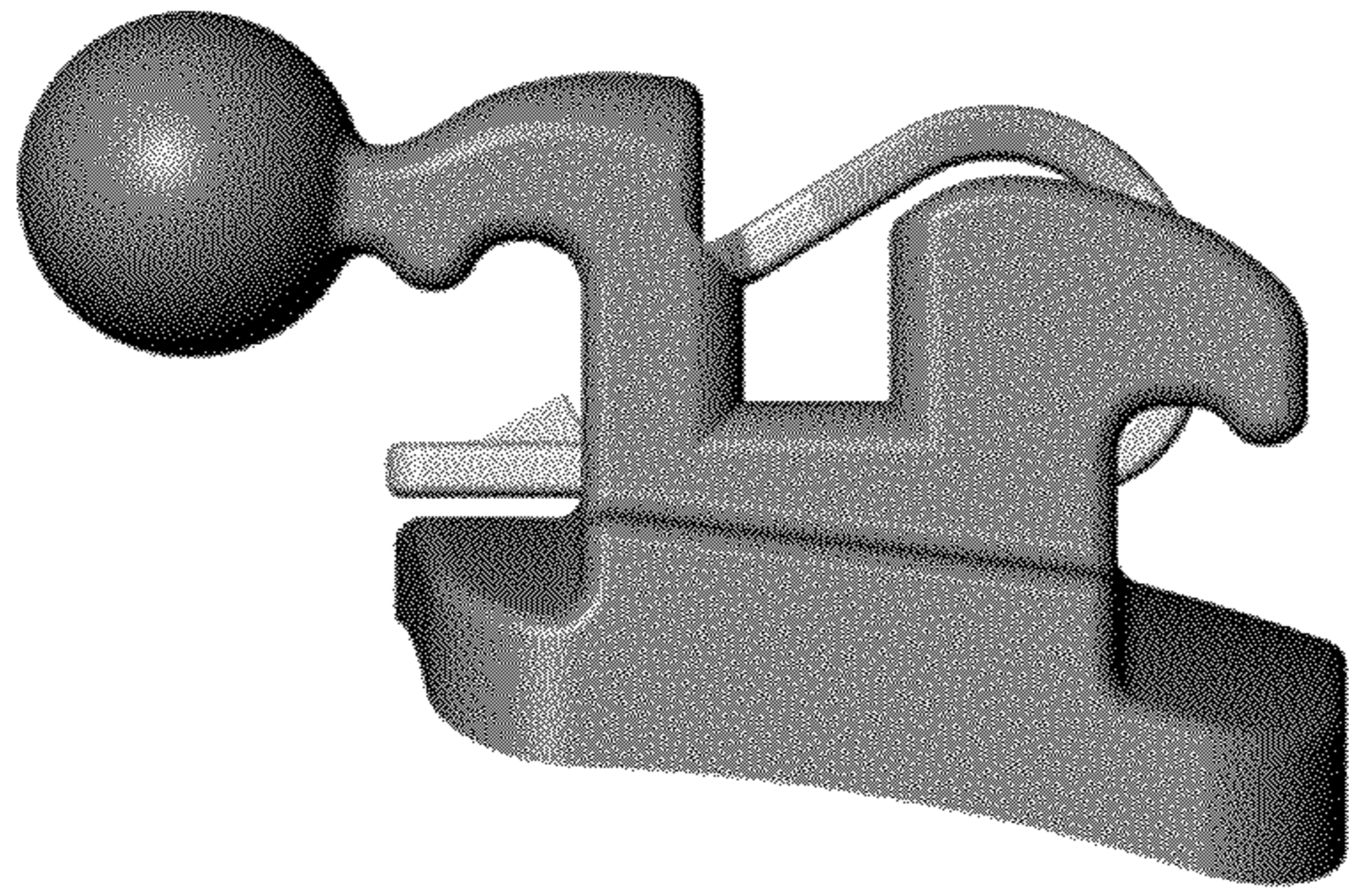

FIG. 4

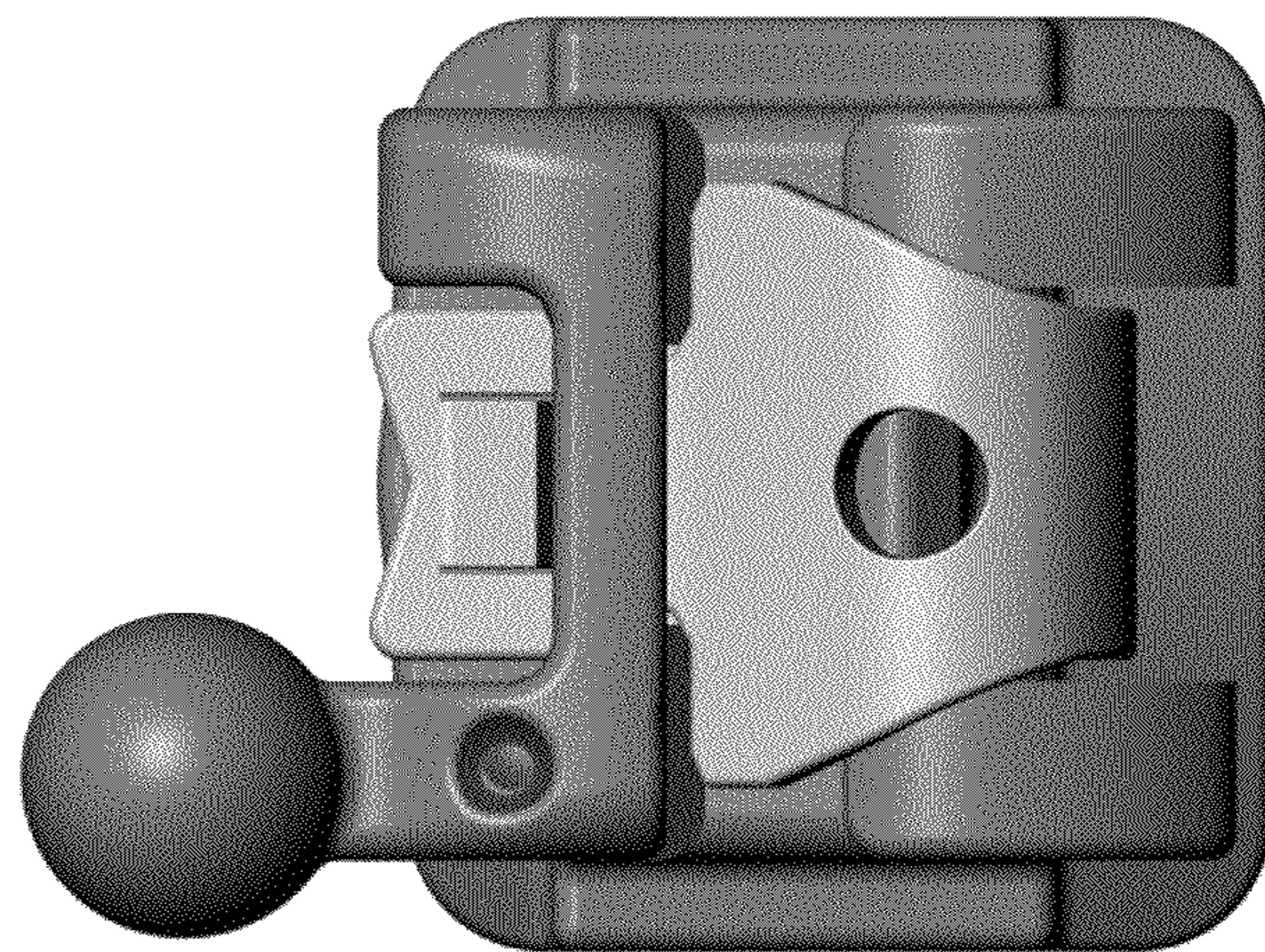

FIG. 5

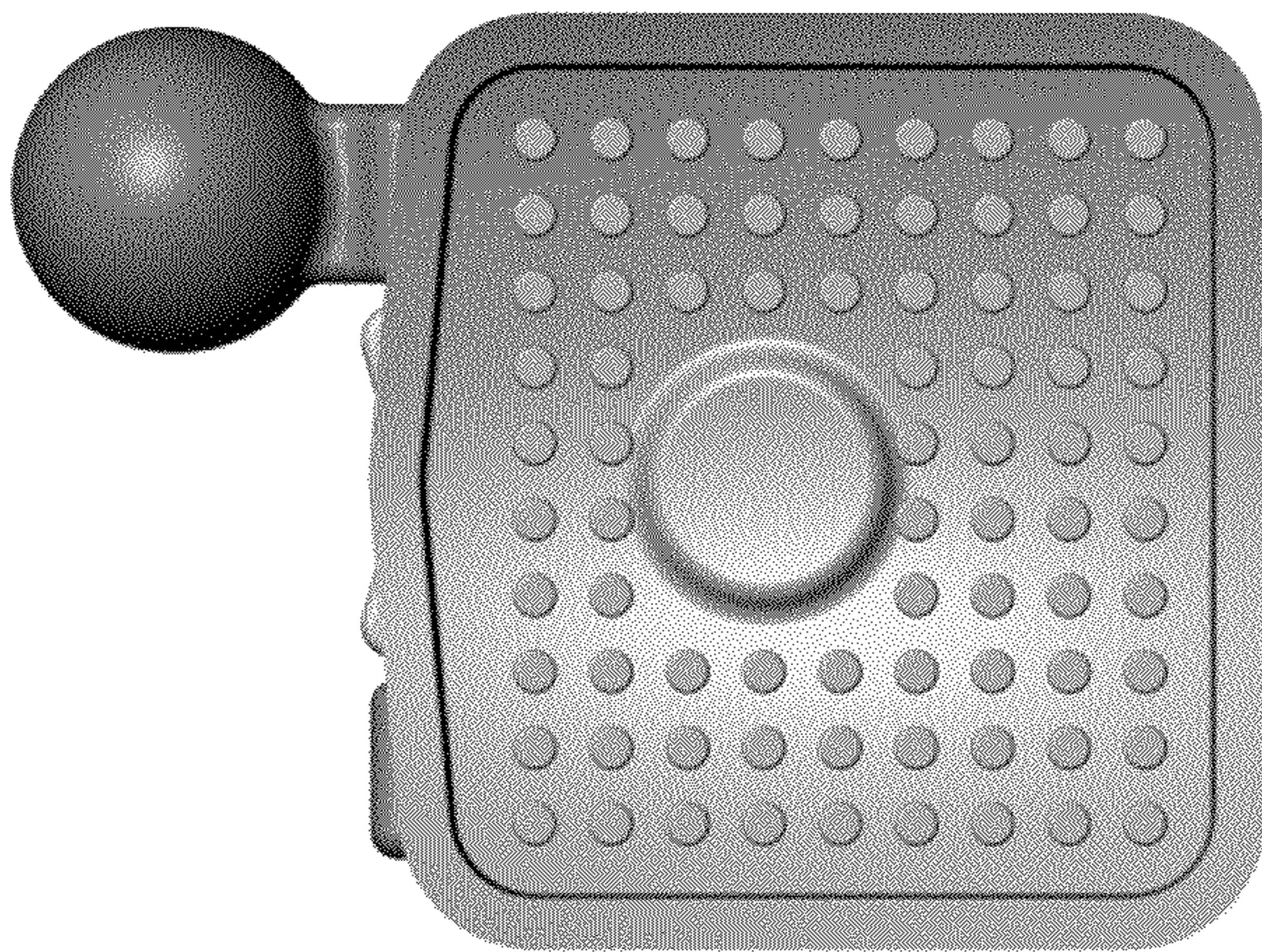

FIG. 6

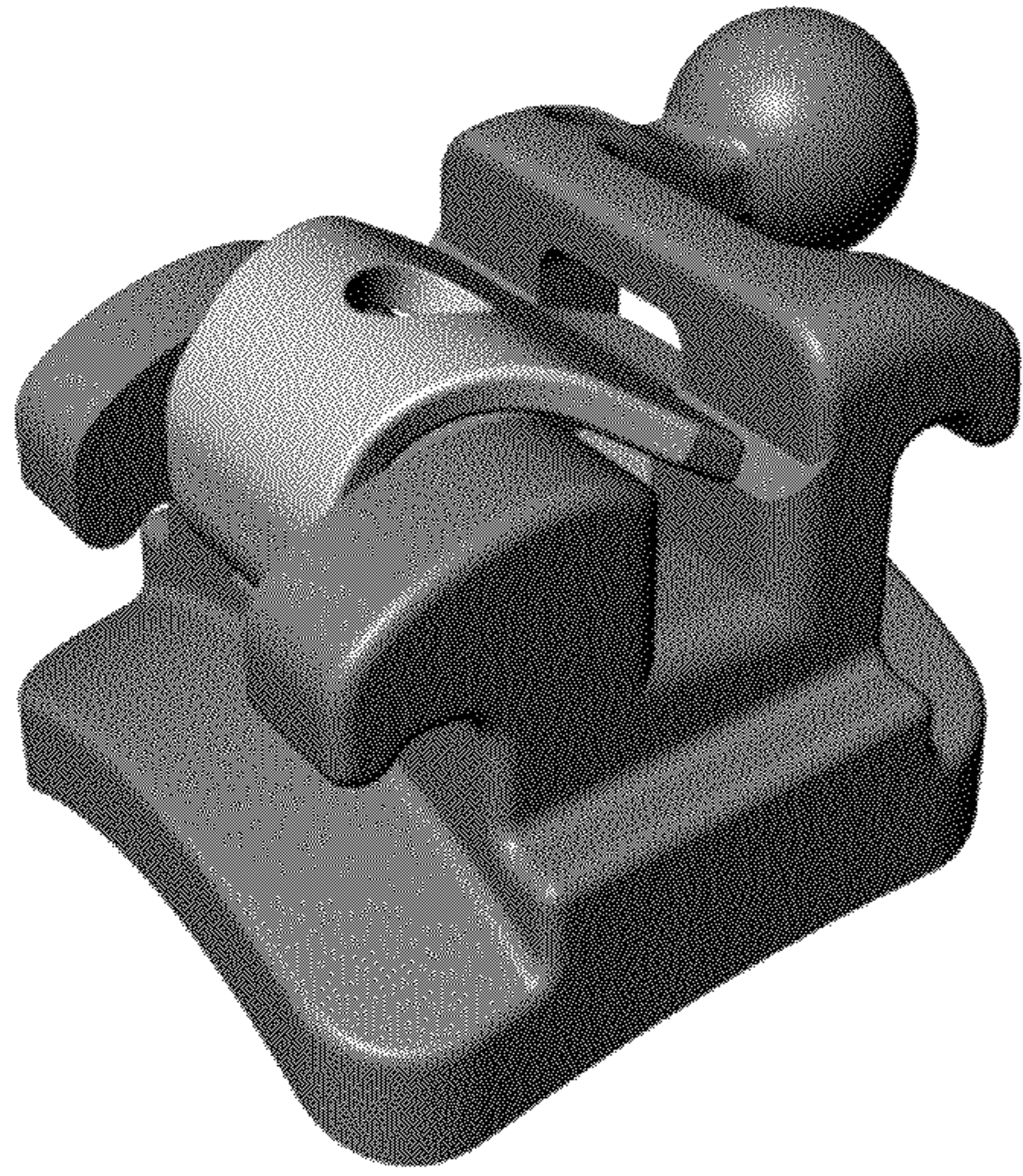

FIG. 7

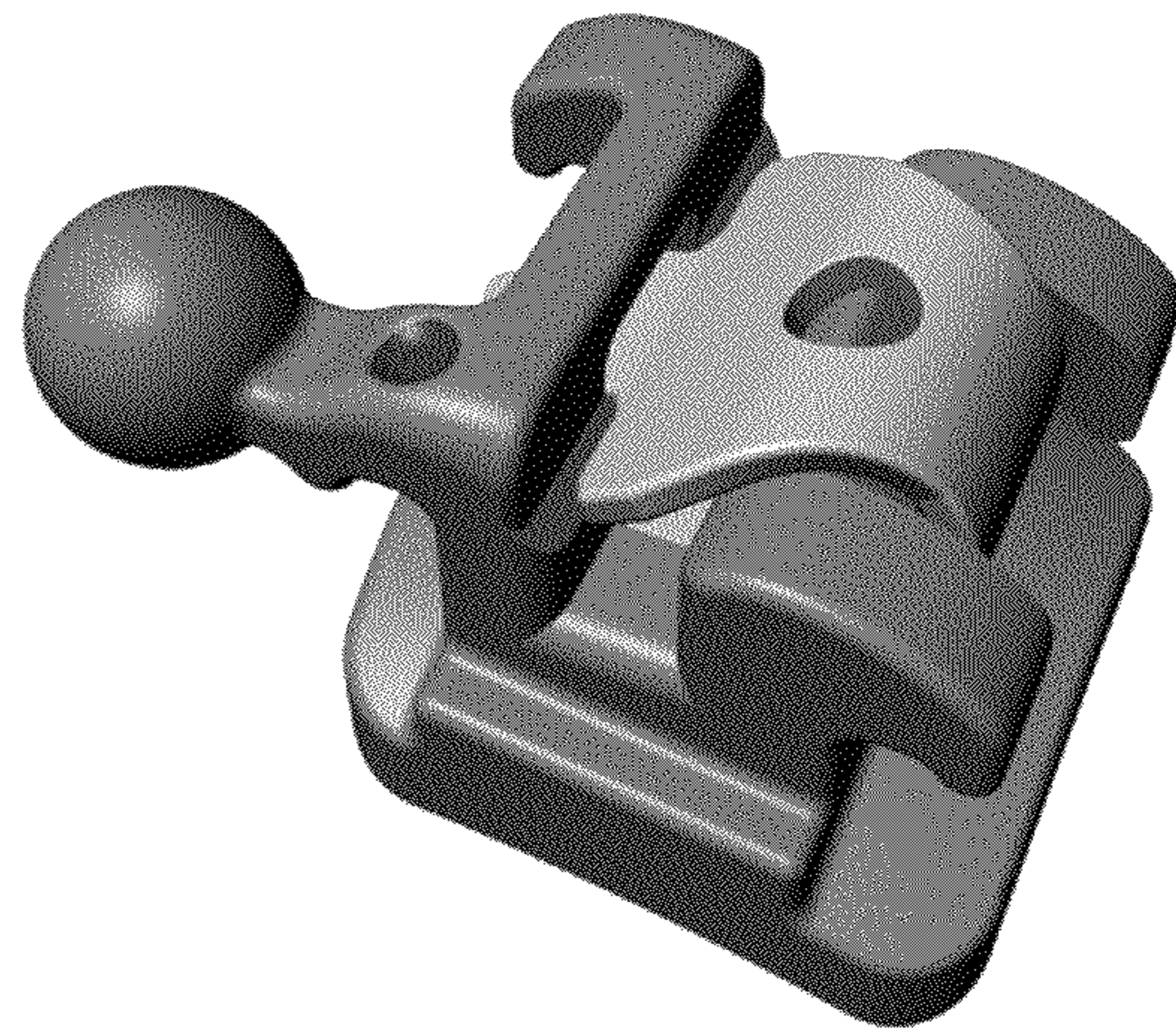

FIG. 8

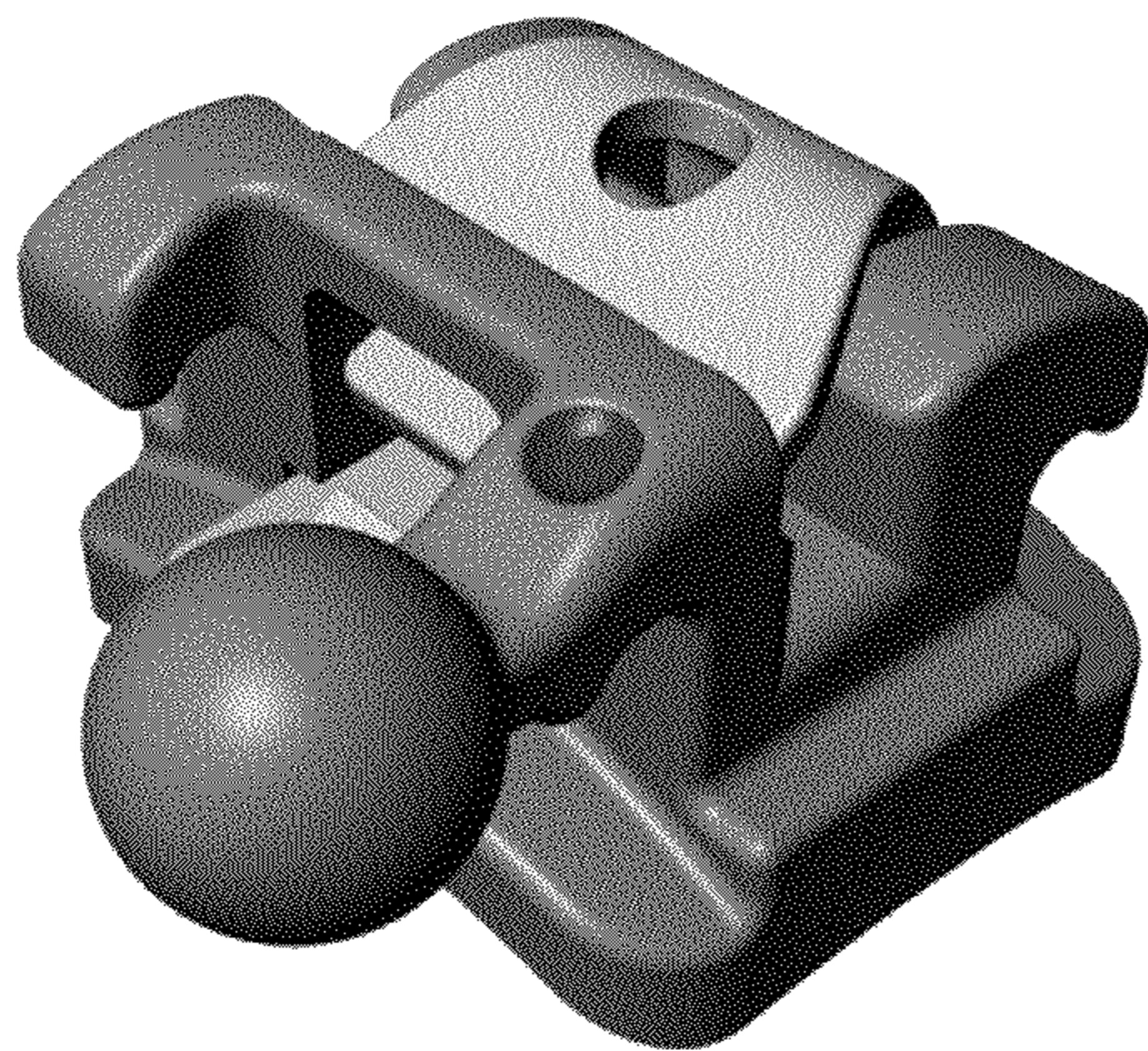

FIG. 9

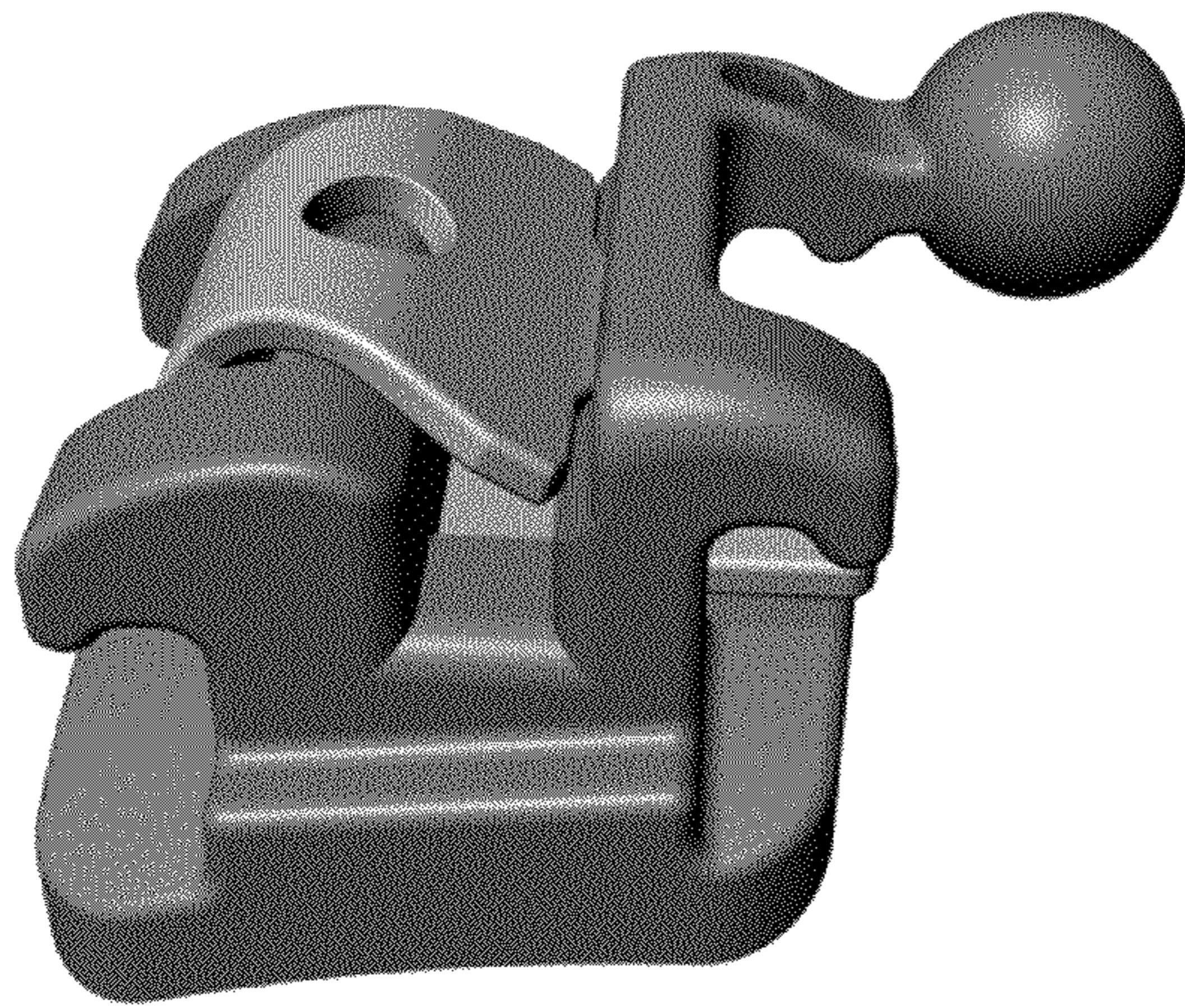

FIG. 10

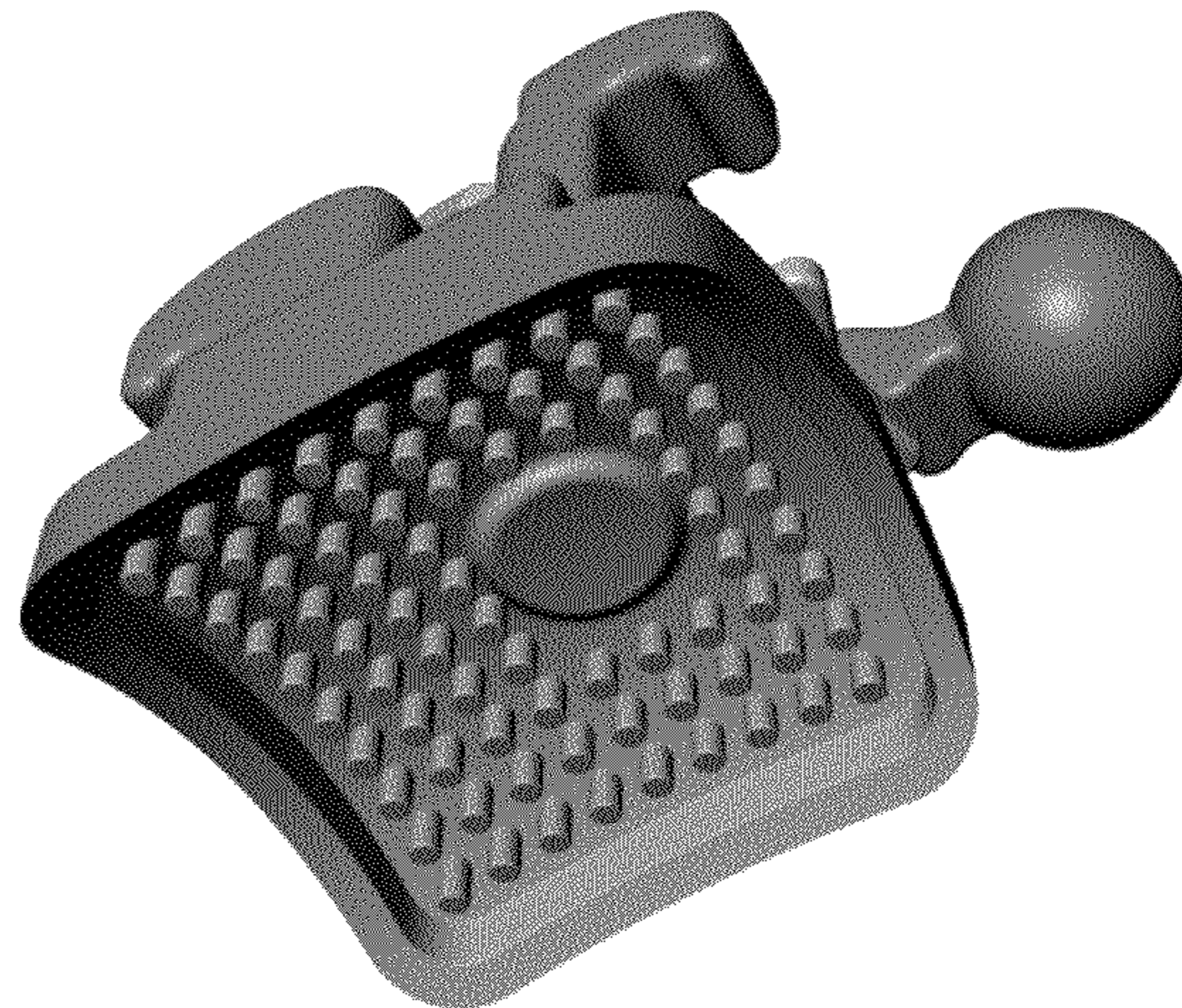

FIG. 11

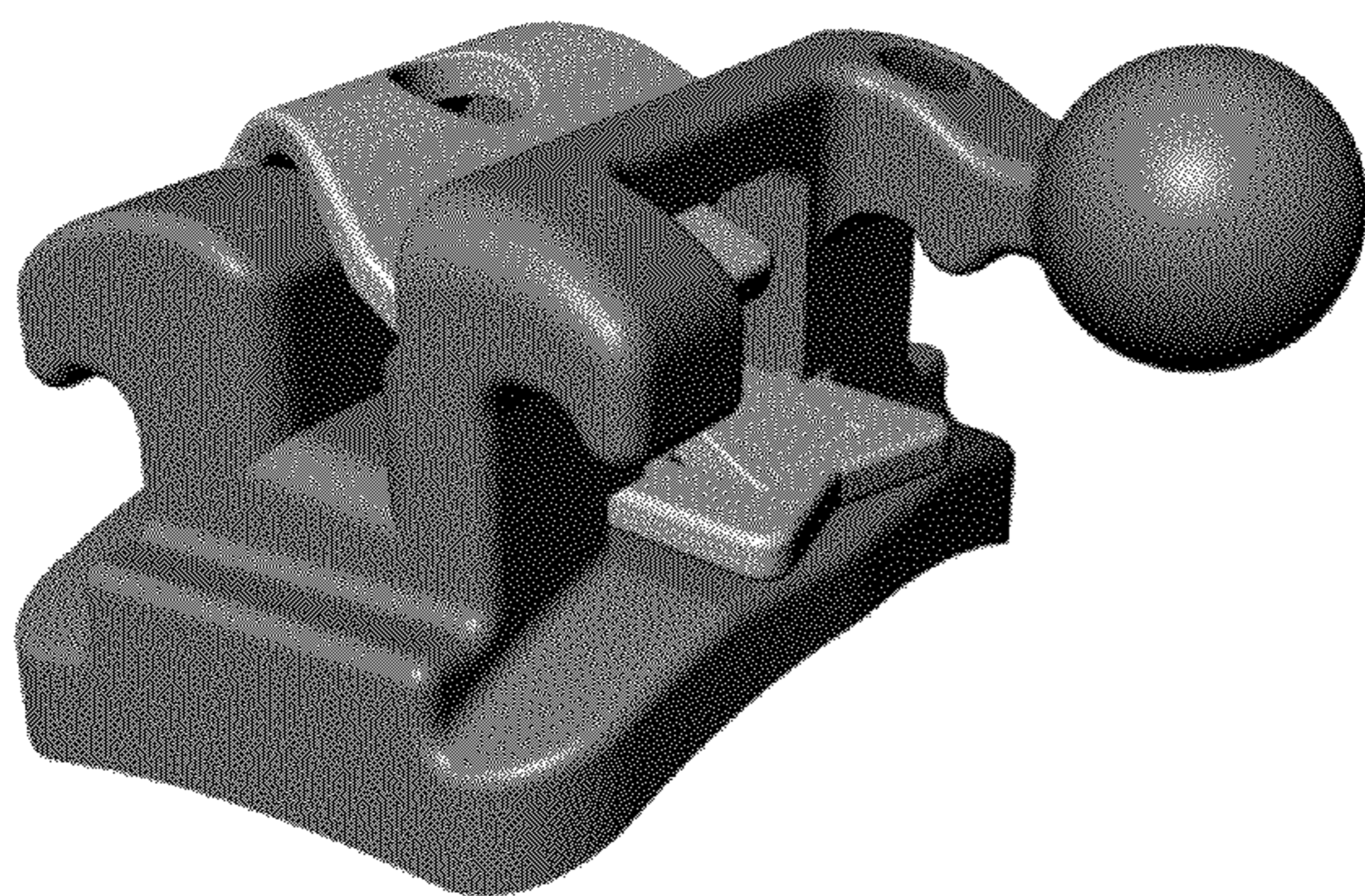

FIG. 12