



US00D706385S

(12) **United States Design Patent**
Tiller

(10) **Patent No.:** **US D706,385 S**
(45) **Date of Patent:** **** Jun. 3, 2014**

(54) **FISHING REEL**

(71) Applicant: **Tiller & Tiller Pty Limited**, Annandale (AU)

(72) Inventor: **Robert Bruce Tiller**, East Balmain (AU)

(73) Assignee: **Tiller & Tiller Pty Limited**, New South Wales (AU)

(**) Term: **14 Years**

(21) Appl. No.: **29/469,213**

(22) Filed: **Oct. 8, 2013**

(30) **Foreign Application Priority Data**

Apr. 8, 2013 (AU) 11655/2013

(51) **LOC (10) Cl.** **22-05**

(52) **U.S. Cl.**
USPC **D22/141**

(58) **Field of Classification Search**
USPC D22/137-142; 242/234-240, 223-224,
242/314, 323, 370
See application file for complete search history.

(56) **References Cited**

U.S. PATENT DOCUMENTS

D374,909 S * 10/1996 Kaneko et al. D22/141
D377,386 S * 1/1997 Yamaguchi D22/141
D384,727 S * 10/1997 Yamaguchi D22/141
D393,689 S * 4/1998 Kaneko et al. D22/137
D404,461 S * 1/1999 Kaneko et al. D22/137

* cited by examiner

Primary Examiner — Catheri Oliver-Garcia

(74) *Attorney, Agent, or Firm* — Michael Best & Friedrich LLP

(57) **CLAIM**

The ornamental design for a fishing reel, as shown and described.

DESCRIPTION

FIG. 1 is a front perspective view of a fishing reel constructed in accordance with an embodiment of the present invention, shown with a flange in an open position;
FIG. 2 is a rear perspective view of the fishing reel shown in FIG. 1, shown with the flange in an open position;
FIG. 3 is a top view of the fishing reel shown in FIGS. 1 and 2, shown with the flange in an open position;
FIG. 4 is a bottom view of the fishing reel shown in FIGS. 1-3, shown with the flange in an open position;
FIG. 5 is a left side view of the fishing reel shown in FIGS. 1-4, shown with the flange in an open position;
FIG. 6 is a right side view of the fishing reel shown in FIGS. 1-5, shown with the flange in an open position;
FIG. 7 is a front view of the fishing reel shown in FIGS. 1-6, shown with the flange in an open position;
FIG. 8 is a rear view of the fishing reel shown in FIGS. 1-7, shown with the flange in an open position;
FIG. 9 is a front perspective view of the fishing reel shown in FIGS. 1-8, shown with the flange in a closed position;
FIG. 10 is a rear perspective view of the fishing reel shown in FIGS. 1-9, shown with the flange in a closed position;
FIG. 11 is a top view of the fishing reel shown in FIGS. 1-10, shown with the flange in a closed position;
FIG. 12 is a bottom view of the fishing reel shown in FIGS. 1-11, shown with the flange in a closed position;
FIG. 13 is a left side view of the fishing reel shown in FIGS. 1-12, shown with the flange in a closed position;
FIG. 14 is a right side view of the fishing reel shown in FIGS. 1-13, shown with the flange in a closed position;
FIG. 15 is a front view of the fishing reel shown in FIGS. 1-14, shown with the flange in a closed position; and,
FIG. 16 is a rear view of the fishing reel shown in FIGS. 1-15, shown with the flange in a closed position.

1 Claim, 8 Drawing Sheets

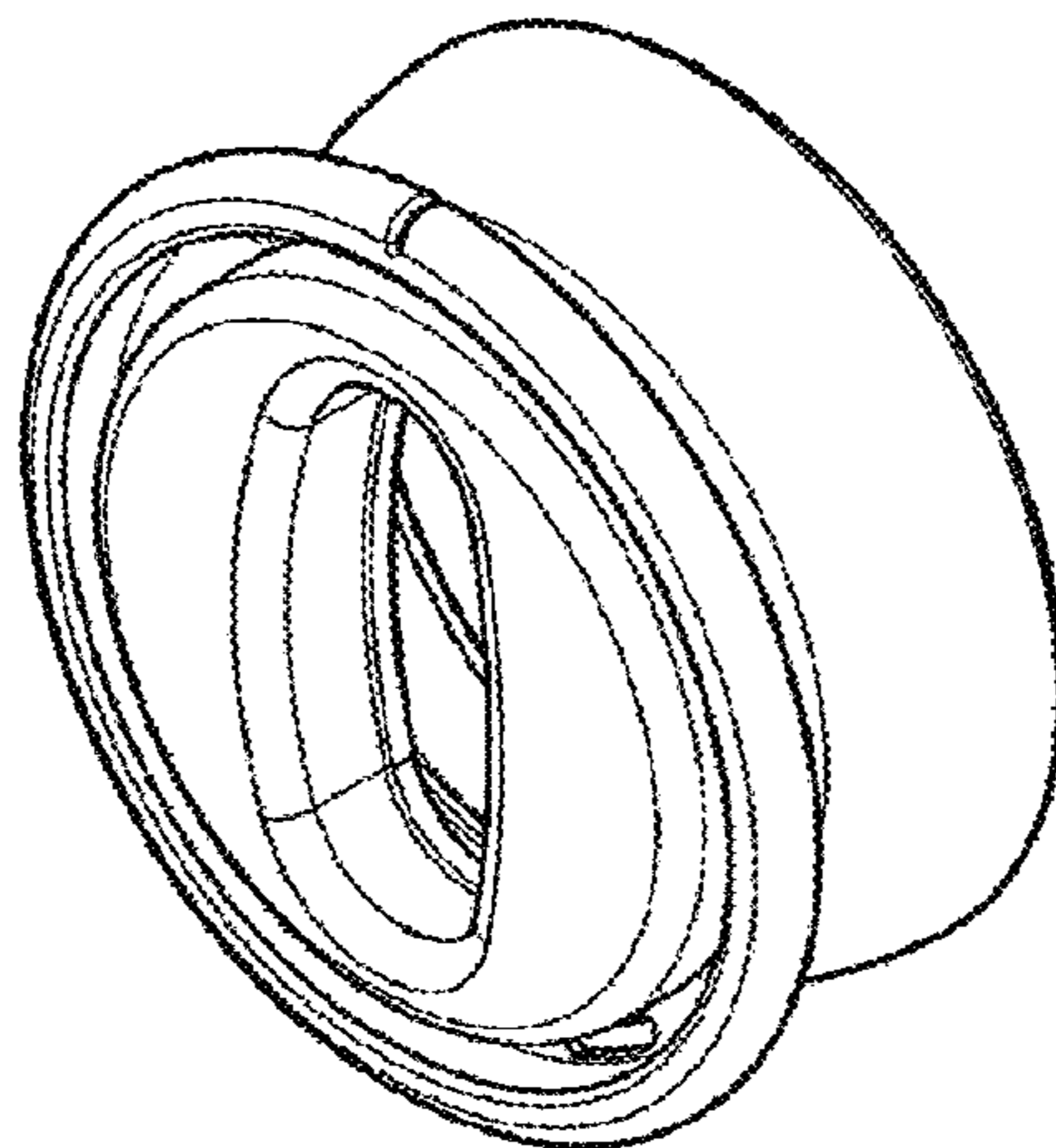

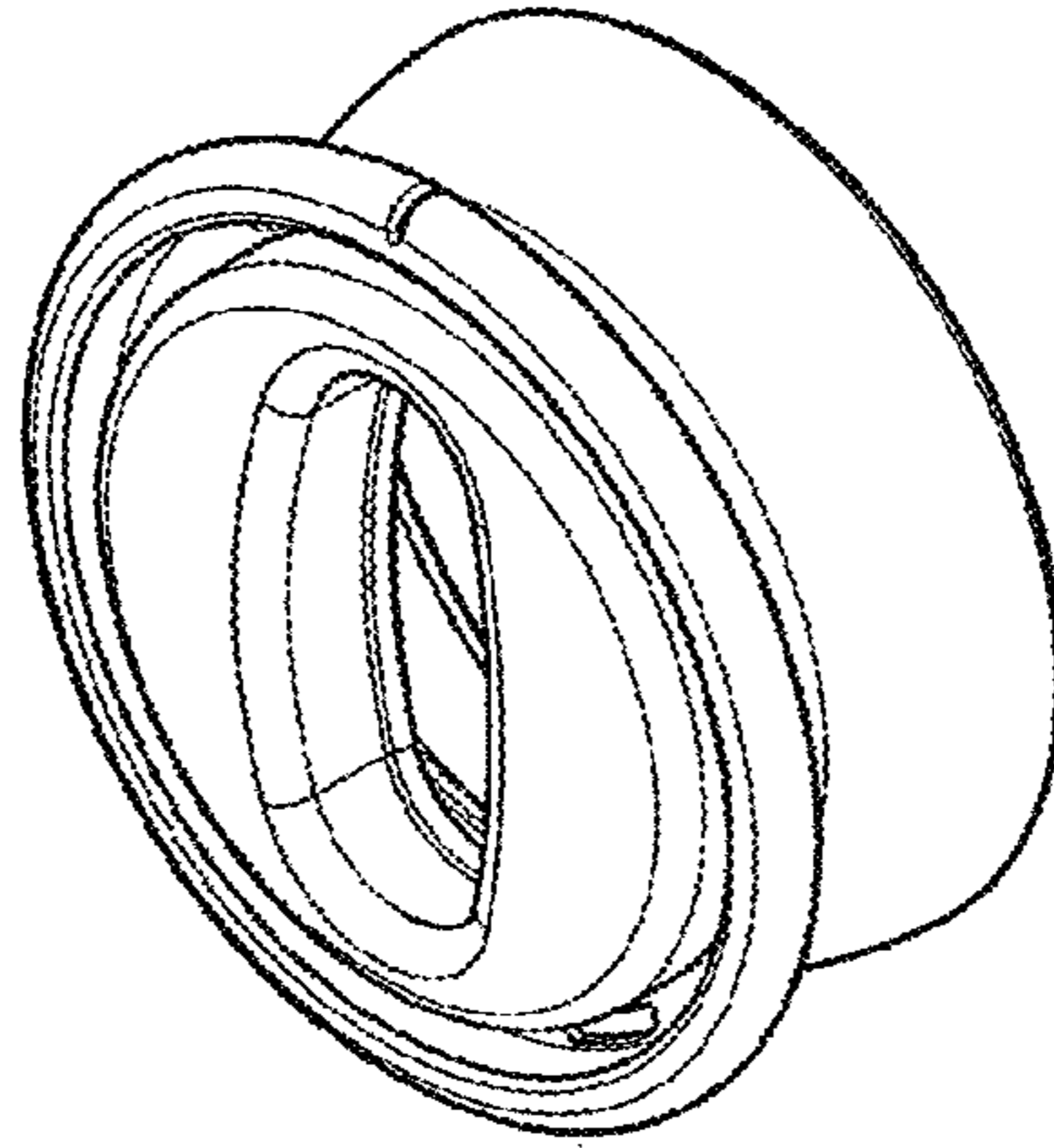

FIGURE 1

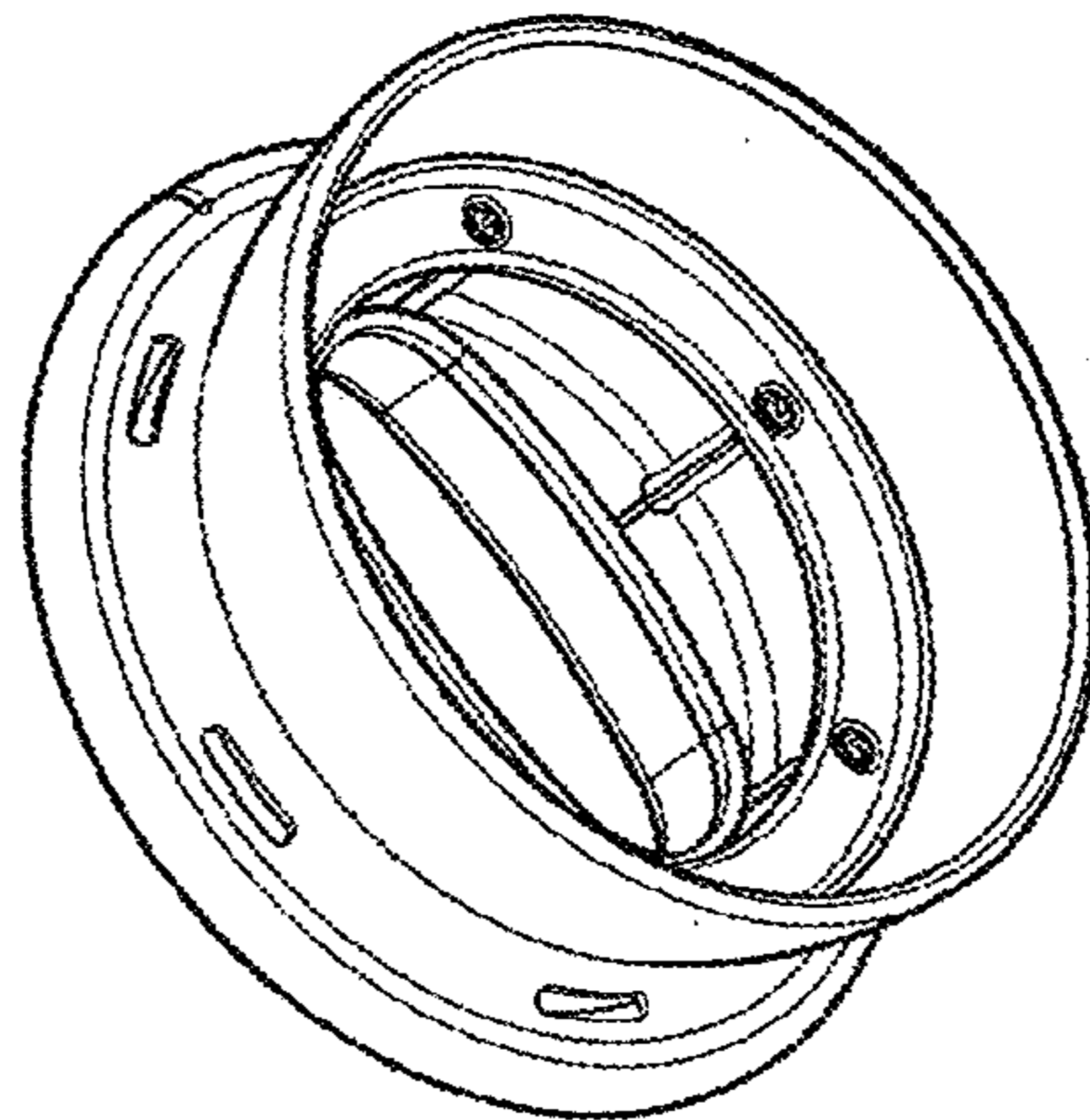

FIGURE 2

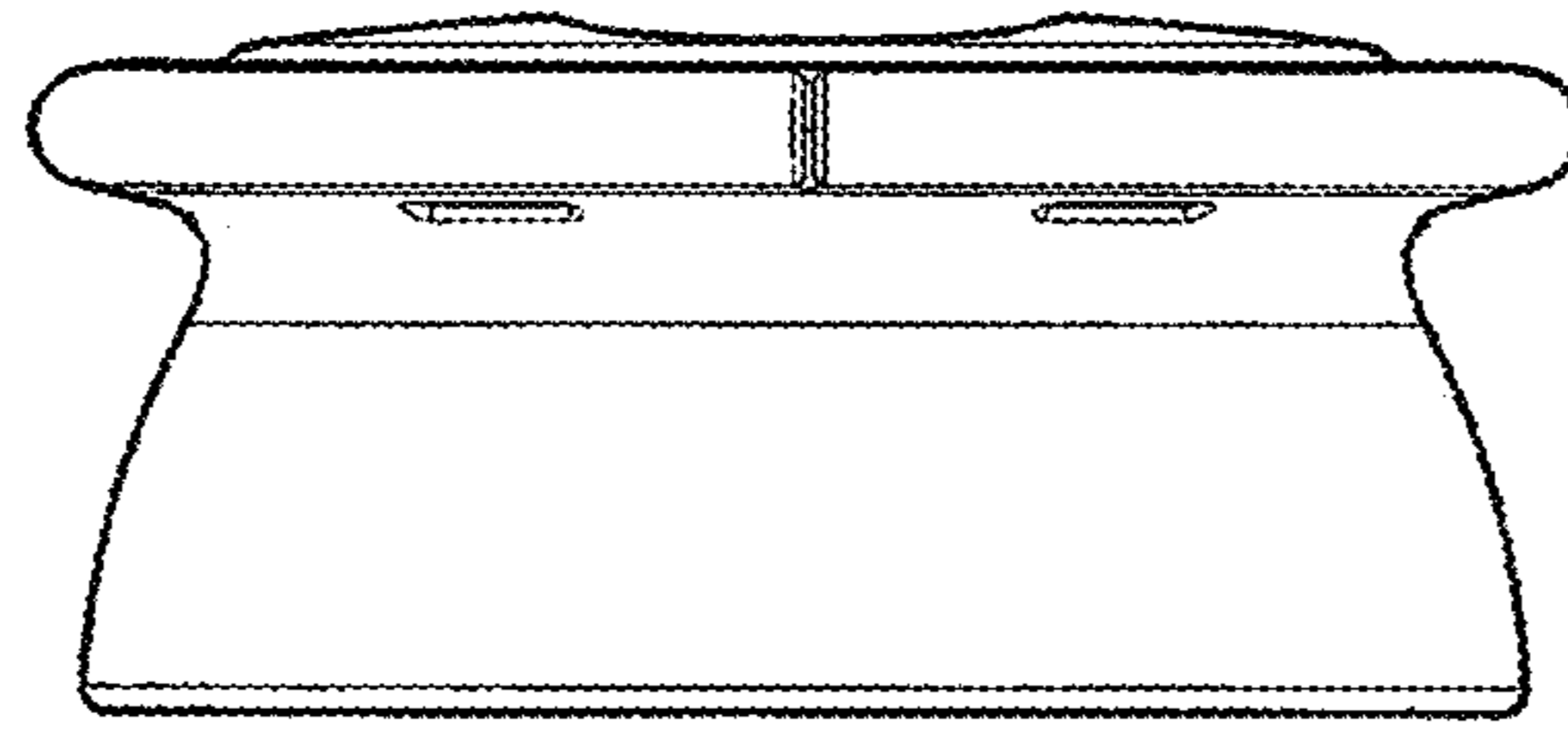

FIGURE 3

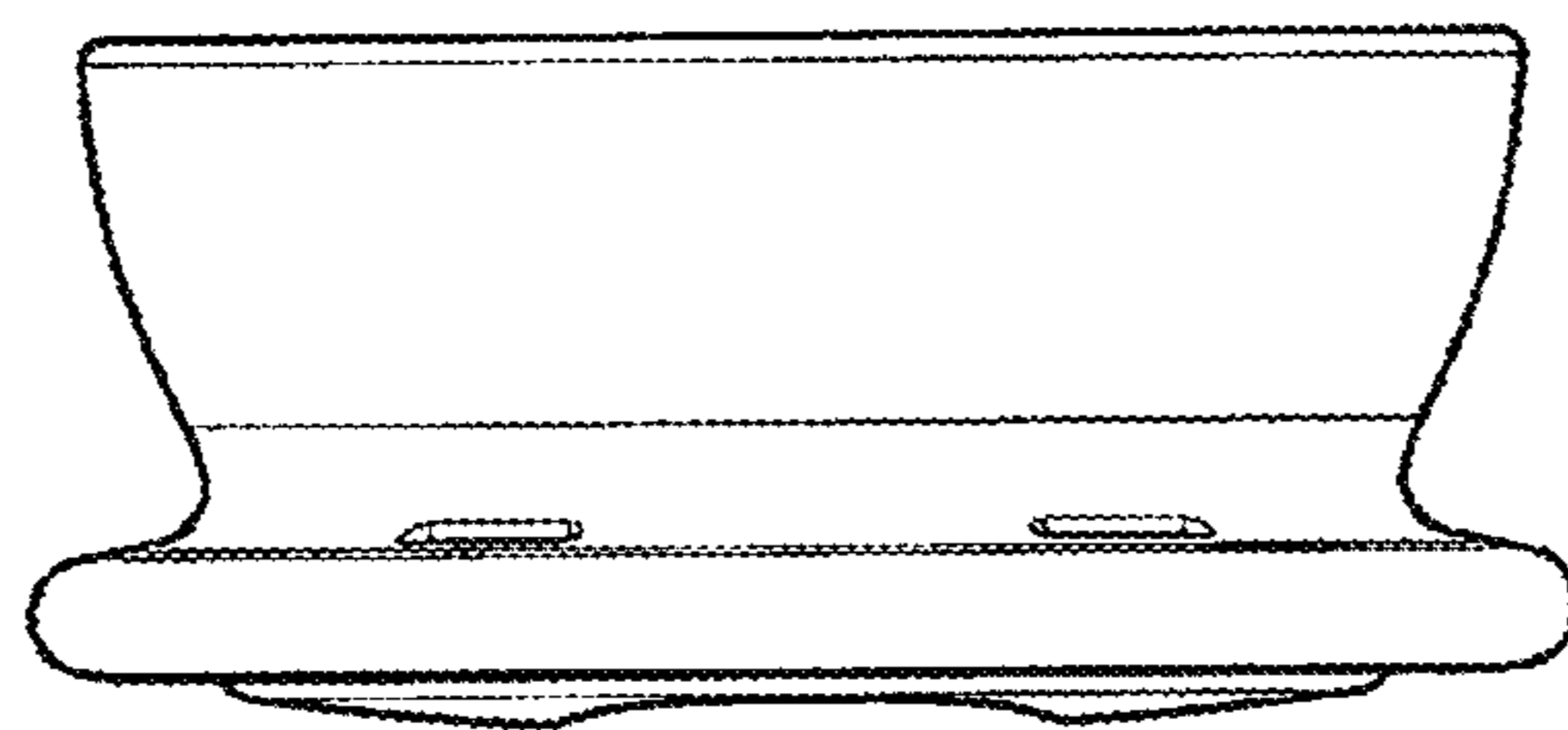

FIGURE 4

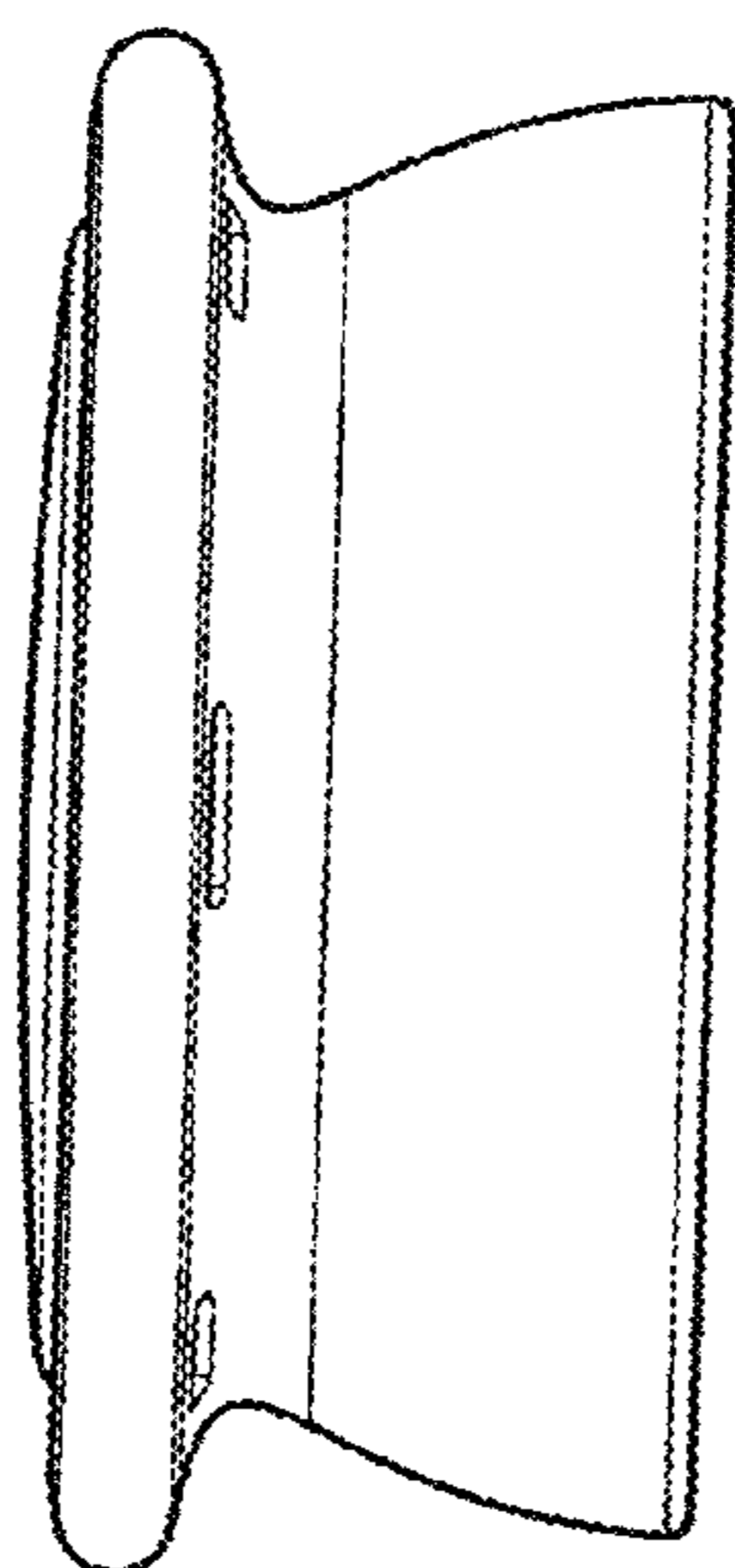

FIGURE 5

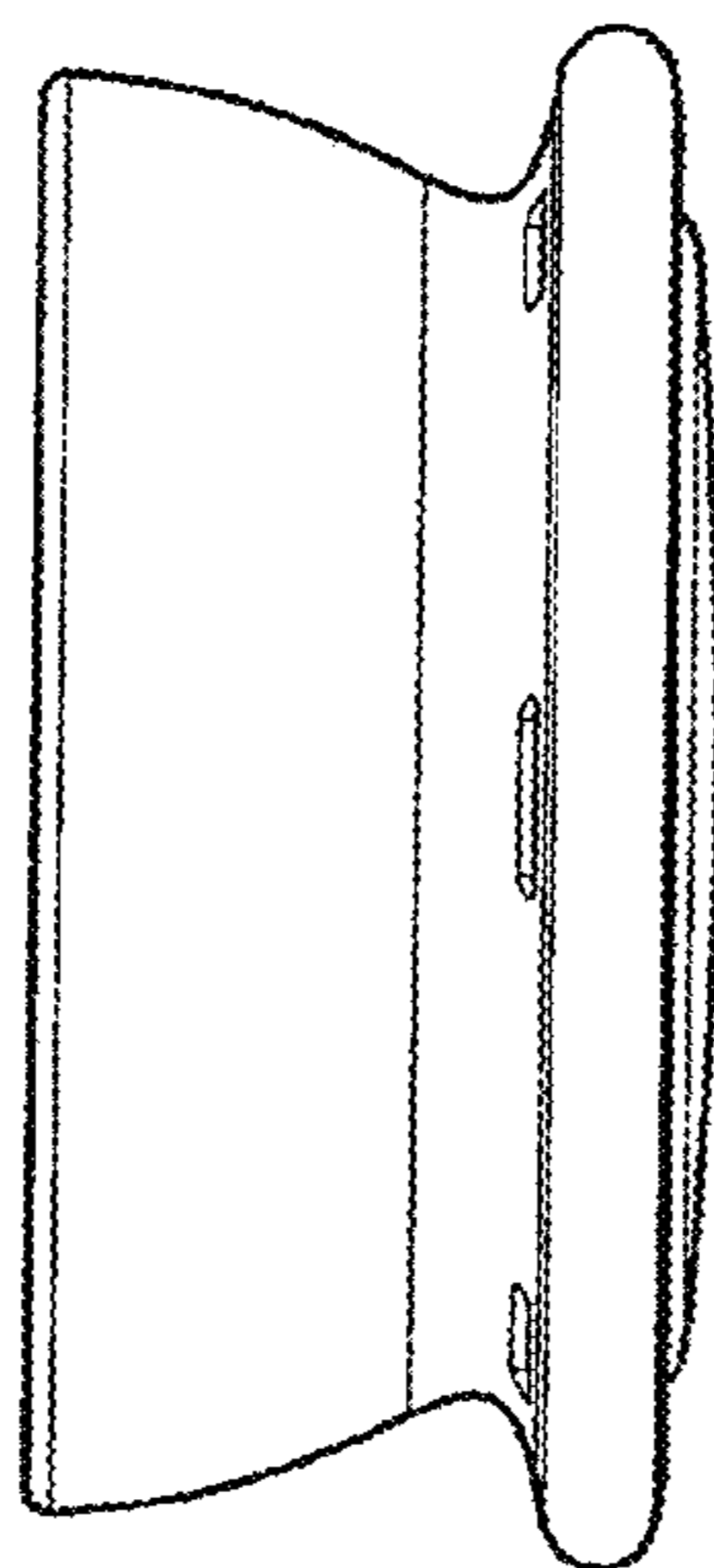

FIGURE 6

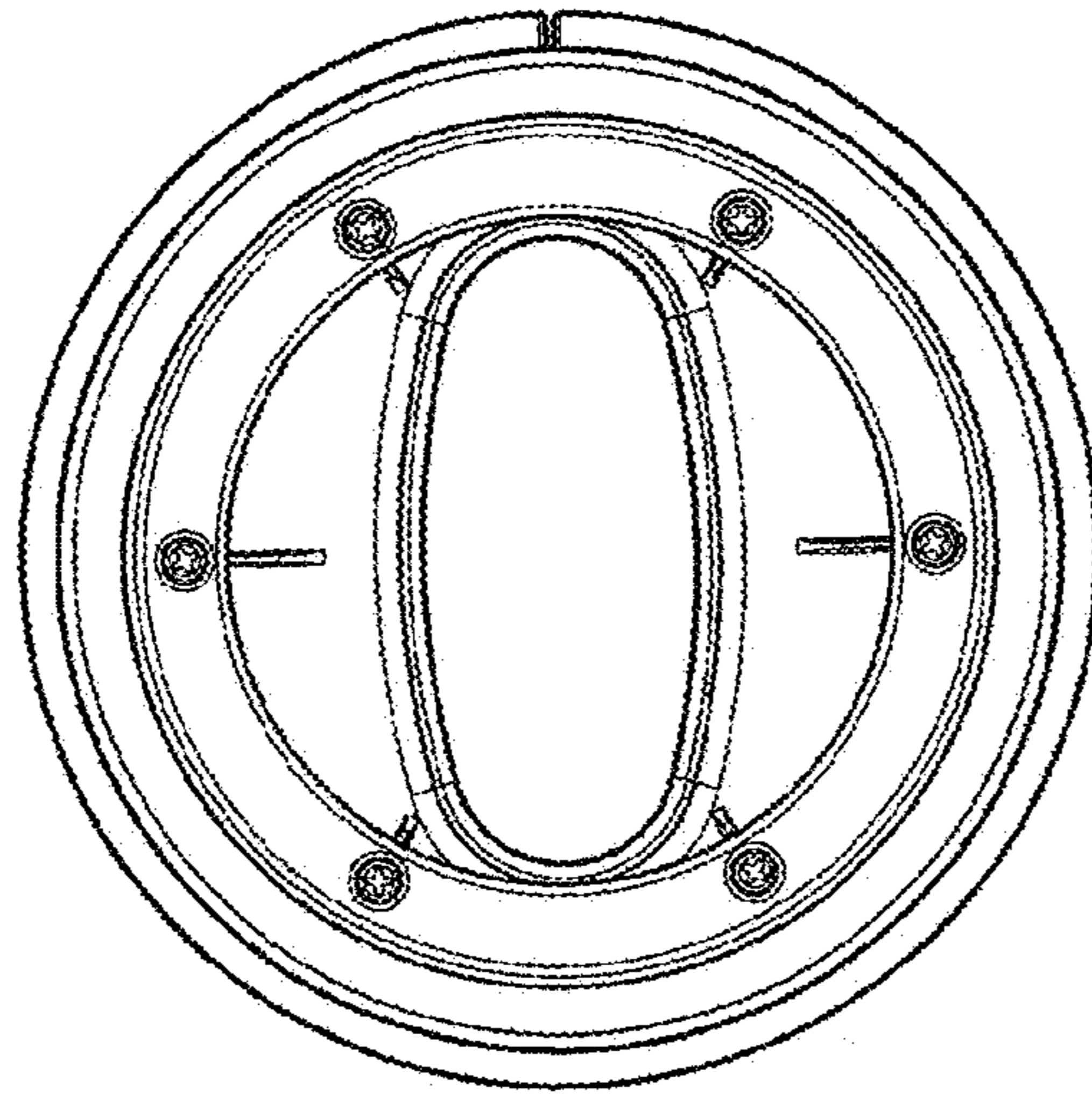

FIGURE 7

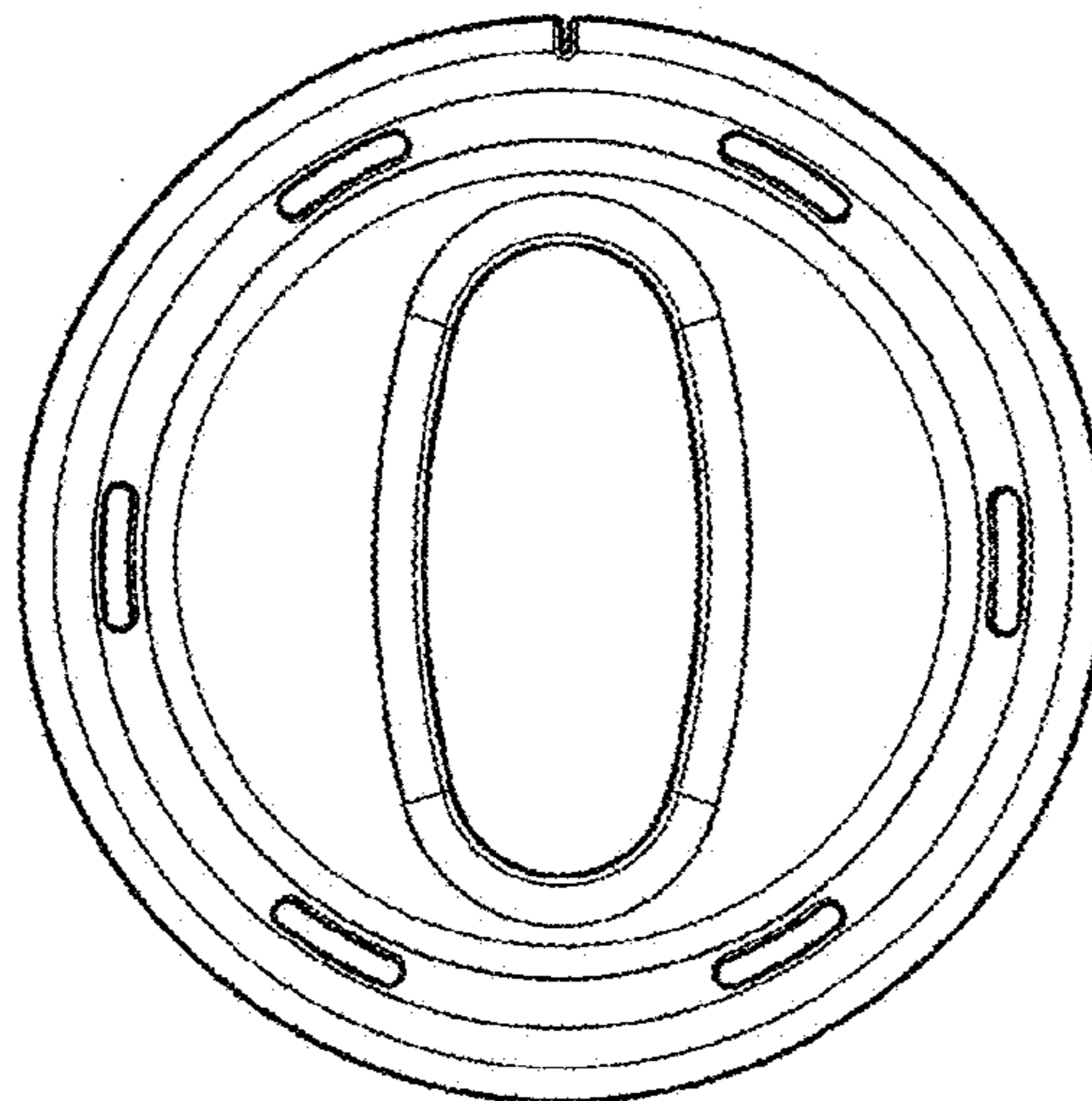

FIGURE 8

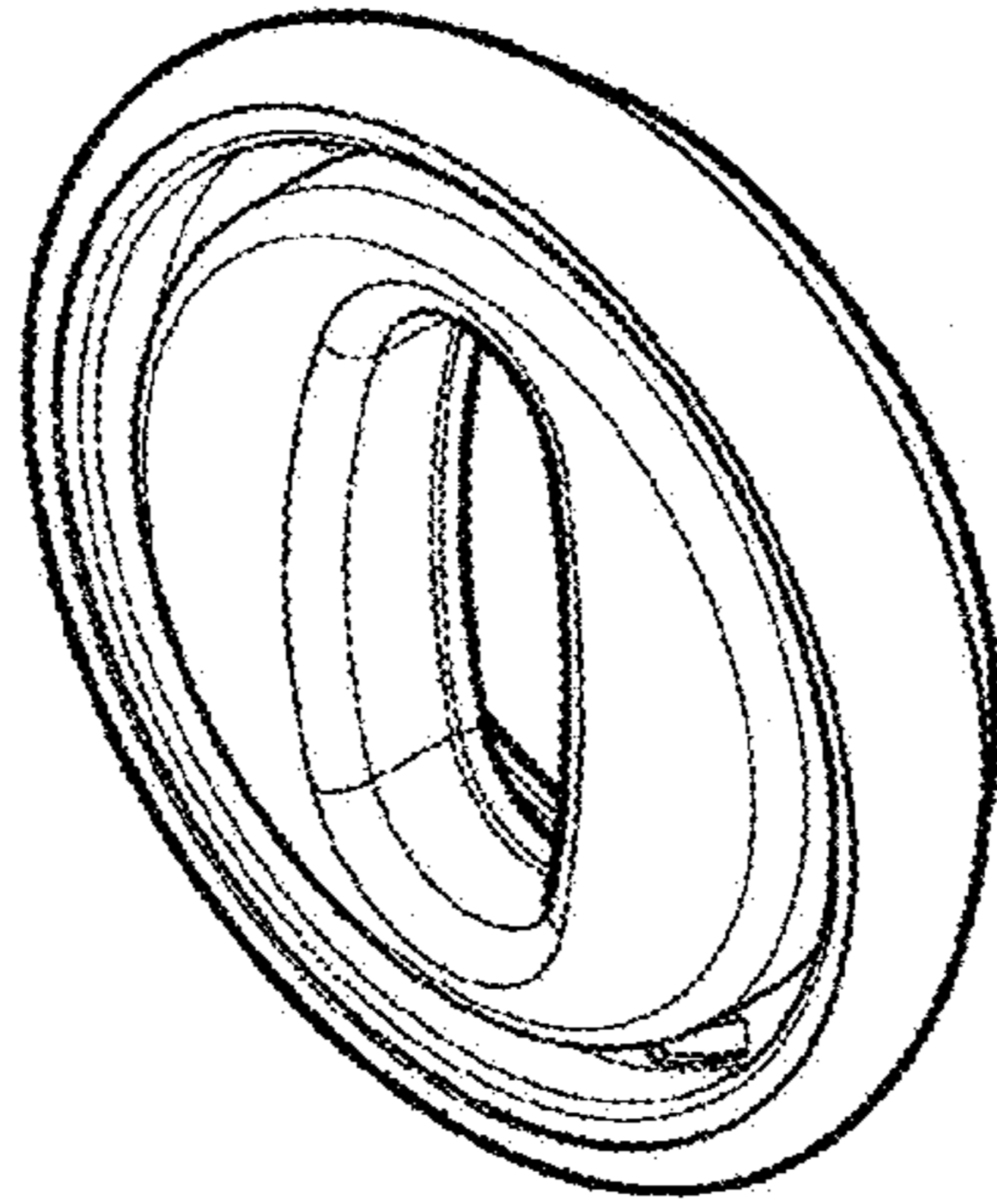

FIGURE 9

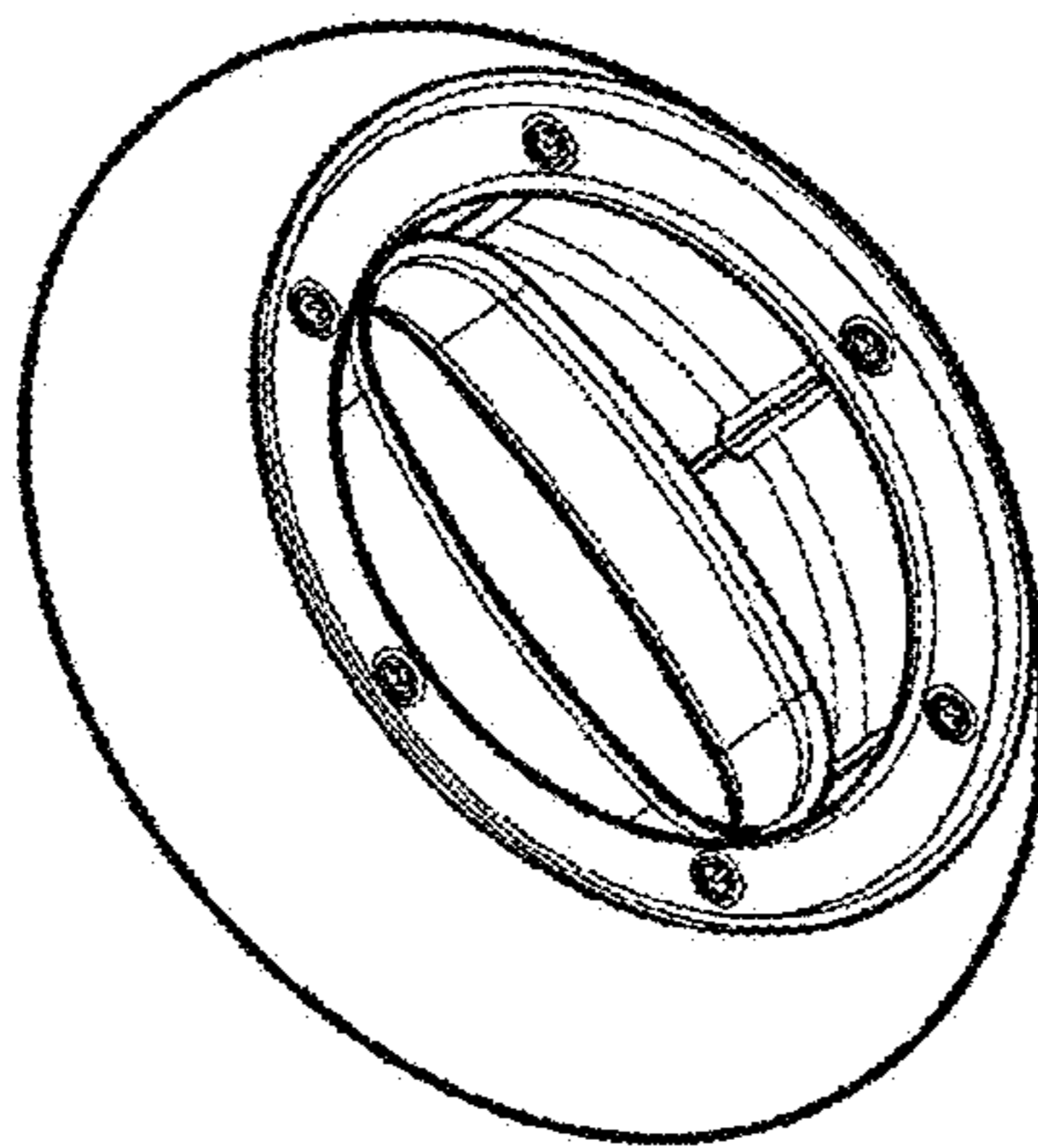

FIGURE 10

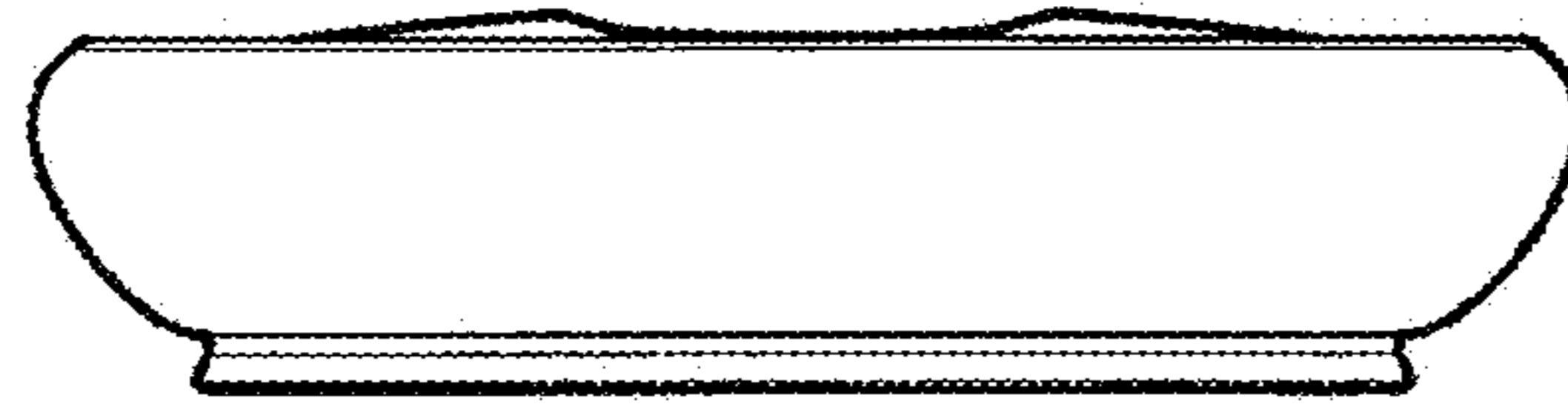

FIGURE 11

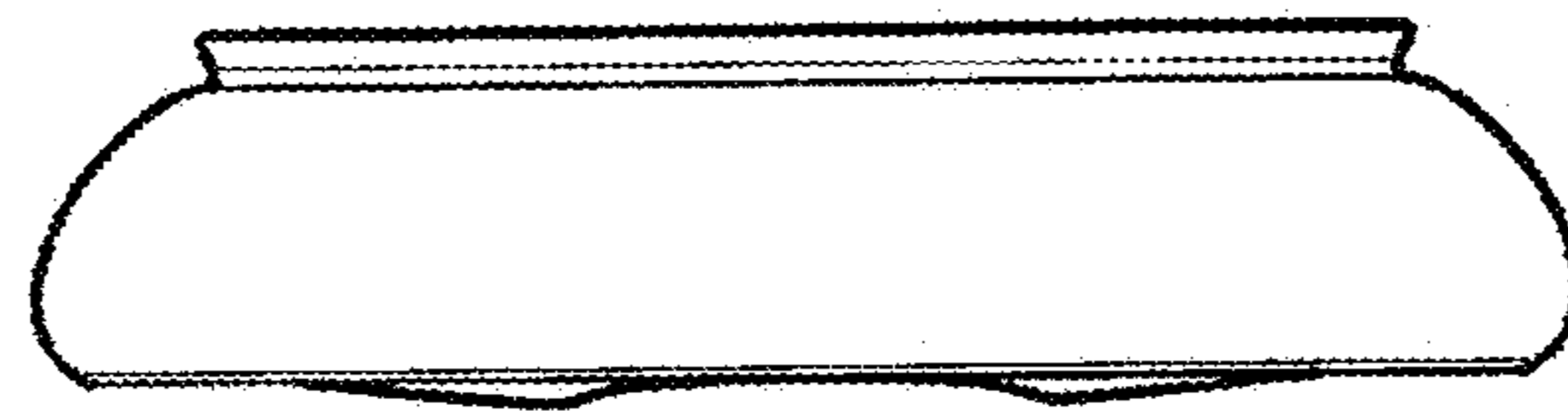

FIGURE 12

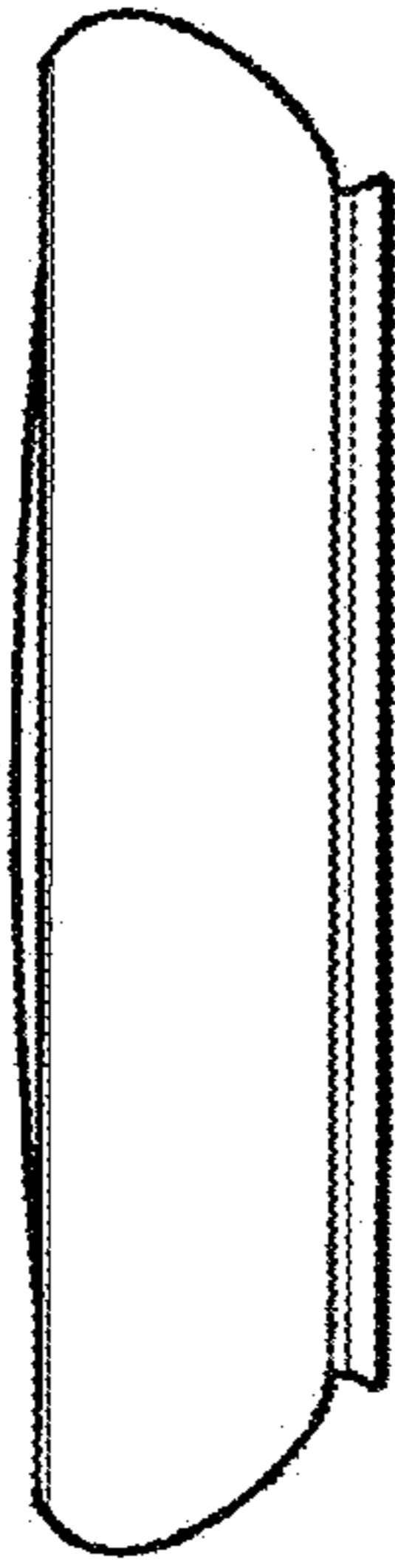

FIGURE 13

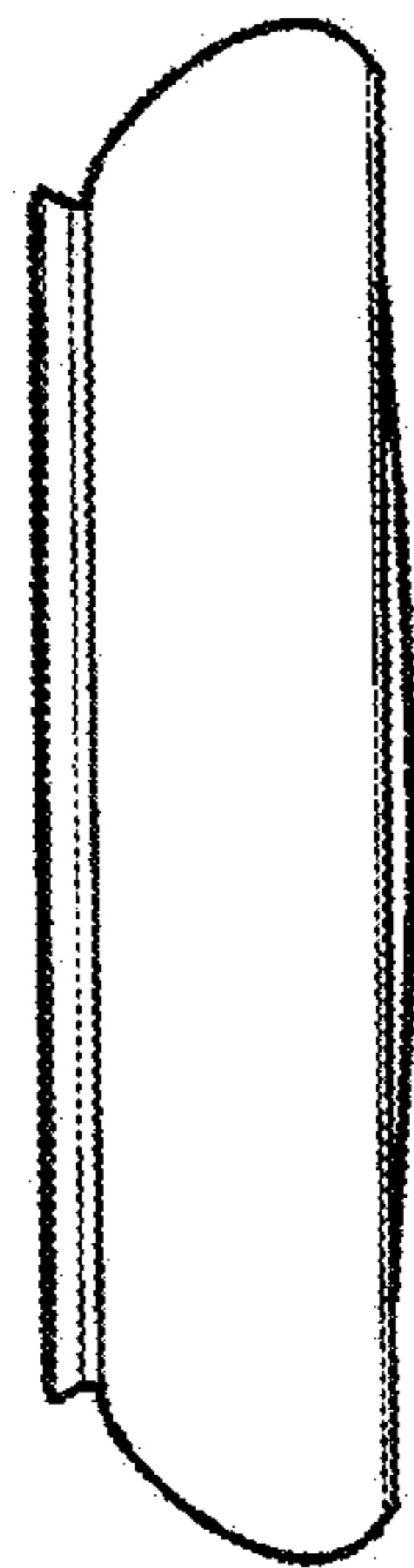

FIGURE 14

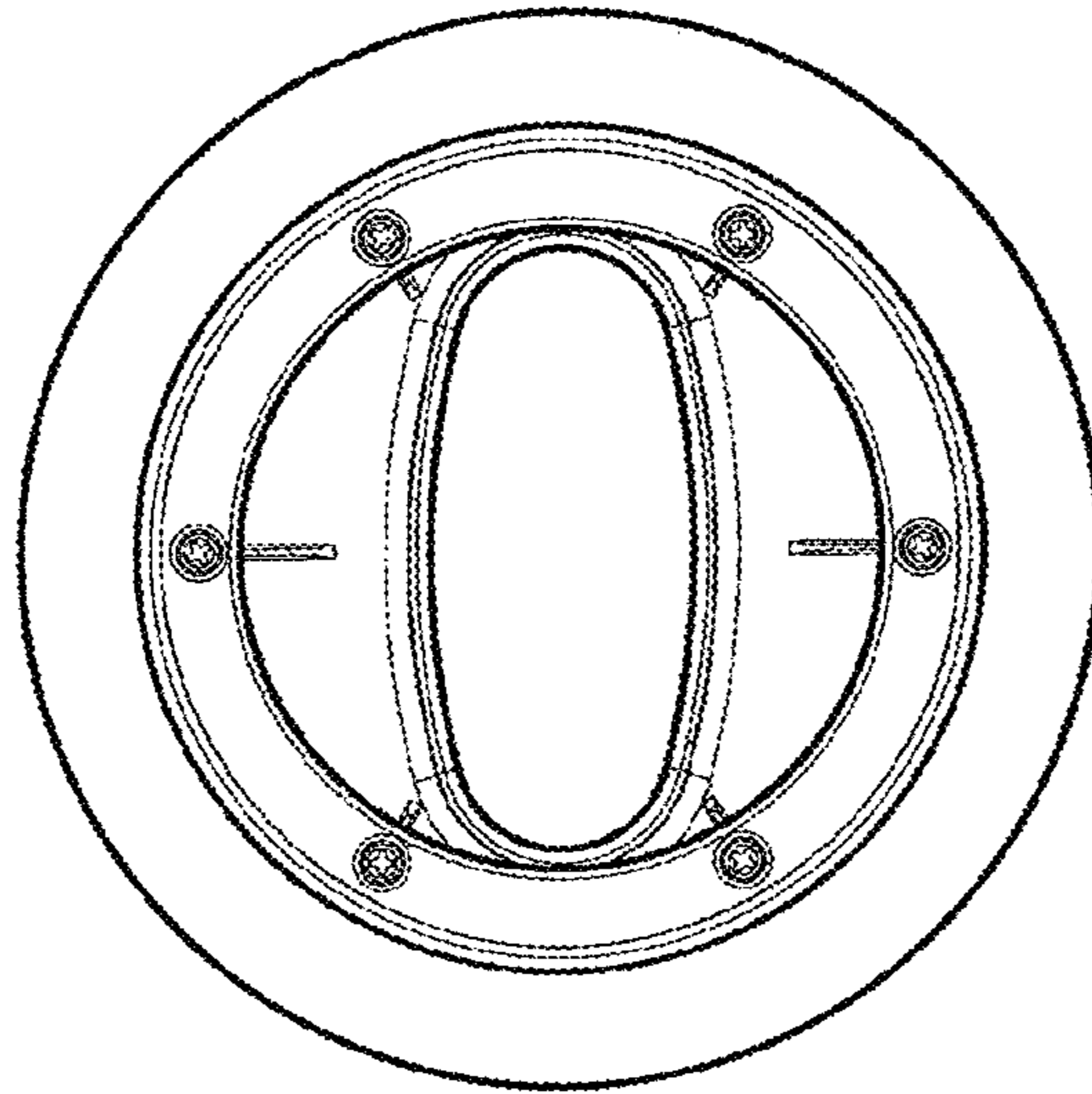

FIGURE 15

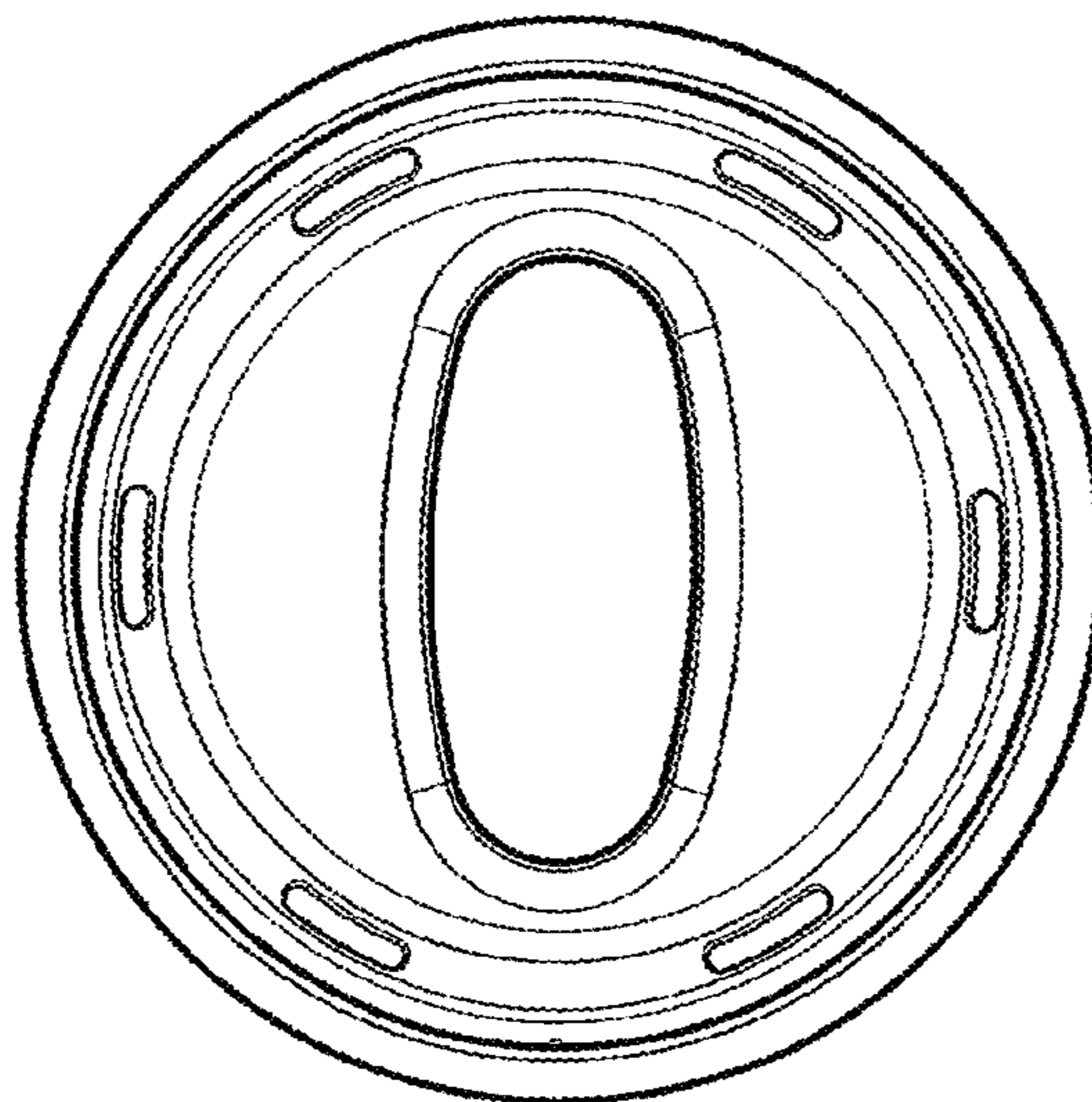

FIGURE 16