



US00D706374S

(12) **United States Design Patent**
Rietz et al.

(10) **Patent No.:** **US D706,374 S**
(45) **Date of Patent:** **** Jun. 3, 2014**

(54) **LIFEJACKET ATTACHMENT**

(71) Applicants: **Peter W. Rietz**, Silverthorne, CO (US);
Matthew Belter, Orland, CA (US)

(72) Inventors: **Peter W. Rietz**, Silverthorne, CO (US);
Matthew Belter, Orland, CA (US)

(**) Term: **14 Years**

(21) Appl. No.: **29/450,891**

(22) Filed: **Mar. 25, 2013**

Related U.S. Application Data

(62) Division of application No. 29/414,039, filed on Feb. 23, 2012, now Pat. No. Des. 678,974.

(51) **LOC (10) Cl.** **29-02**

(52) **U.S. Cl.**
USPC **D21/805**

(58) **Field of Classification Search**
USPC D21/804, 805; D29/100, 101.1, 101, 4;
2/456, 458, 467, 463; 441/88, 89, 106,
441/108, 111, 114-117
See application file for complete search history.

(56) **References Cited**

U.S. PATENT DOCUMENTS

D280,005 S *	8/1985	Jones	D21/805
D310,700 S *	9/1990	Jones	D21/805
4,986,786 A *	1/1991	Helt et al.	441/120
D319,679 S *	9/1991	Haley	D21/803
D344,120 S *	2/1994	Helt et al.	D21/804
5,516,320 A *	5/1996	LaPlant	441/106

5,685,753 A *	11/1997	Canela et al.	441/129
5,791,958 A *	8/1998	Yeung	441/130
5,921,898 A *	7/1999	McDonald	482/111

* cited by examiner

Primary Examiner — Zenia Bennett

(74) *Attorney, Agent, or Firm* — Margaret Polson; Oppedahl Patent Law Firm LLC

(57) **CLAIM**

We claim the ornamental design for the lifejacket attachment, as shown and described.

DESCRIPTION

FIG. 1 is a top plan view of our design for a lifejacket attachment.

FIG. 2 is a side elevation view of FIG. 1 showing the right and left sides which are mirror images.

FIG. 3 is a bottom plan view of FIG. 1.

FIG. 4 is a front elevation view of FIG. 1.

FIG. 5 is a back elevation view of FIG. 1.

FIG. 6 is a perspective view of the lifejacket attachment showing the configuration when in use.

FIG. 7 is a top plan view of a second embodiment of our design for a lifejacket attachment.

FIG. 8 is a side elevation view of FIG. 7 showing the right and left sides which are mirror images.

FIG. 9 is a bottom plan view of FIG. 7.

FIG. 10 is a front elevation view of FIG. 7.

FIG. 11 is a back elevation view of FIG. 7; and,

FIG. 12 is a perspective view of the second embodiment showing the configuration of the lifejacket attachment when in use.

The dashed-dotted lines shown with each embodiment represent unclaimed subject matter and form no part of the claimed design. The dashed-dashed lines shown on each embodiment represent stitching which forms a part of the claimed design.

1 Claim, 6 Drawing Sheets

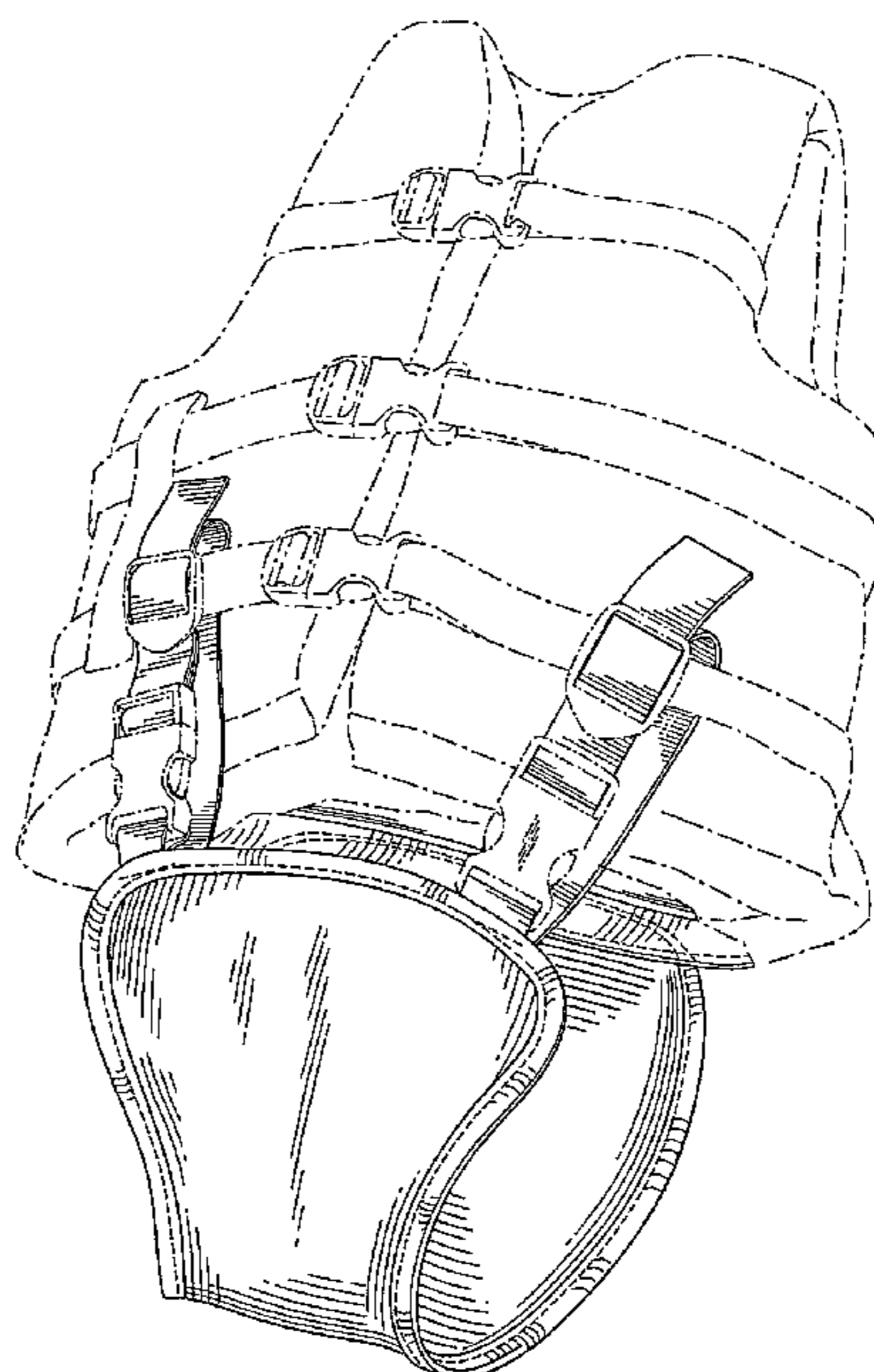
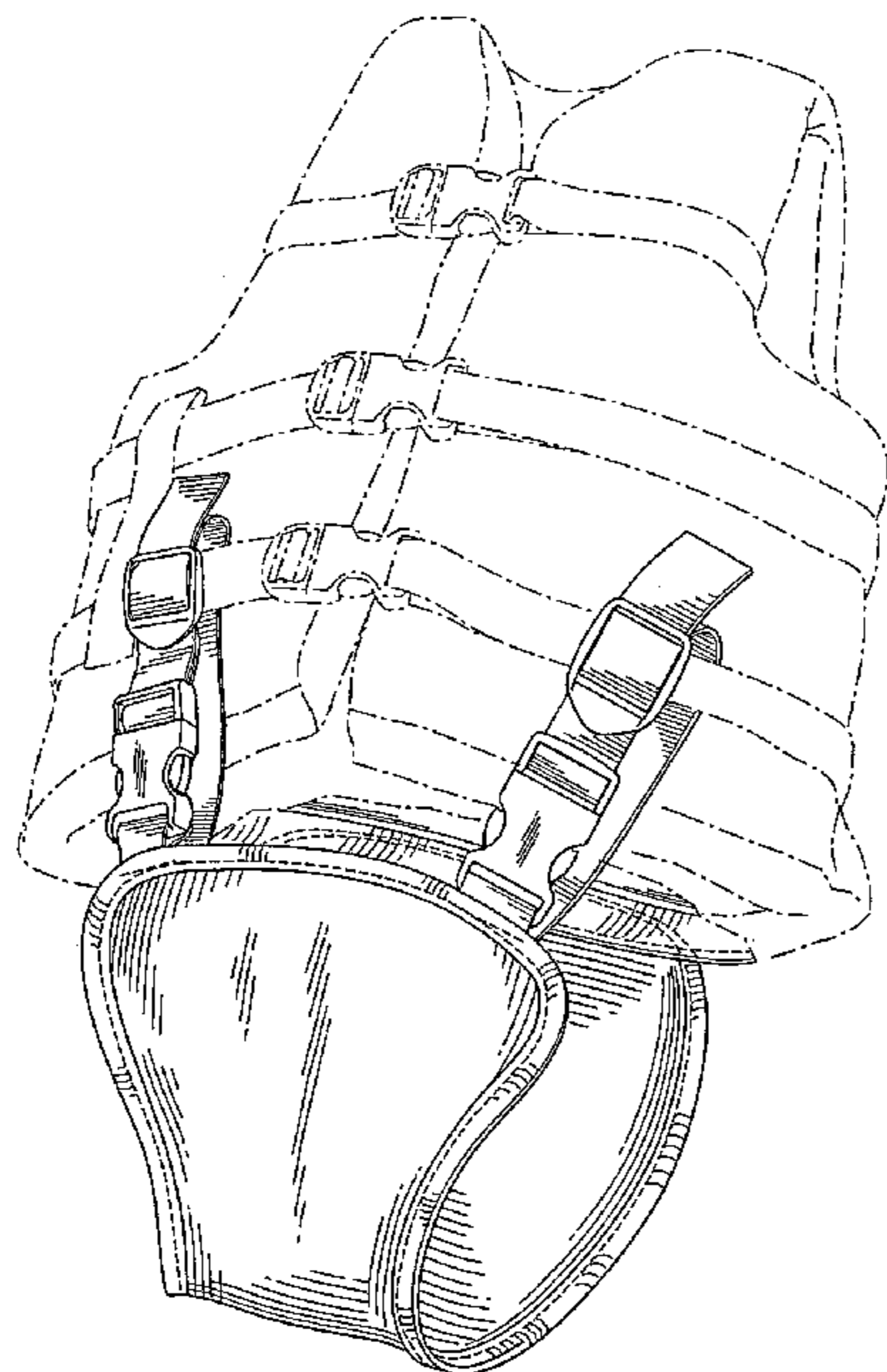

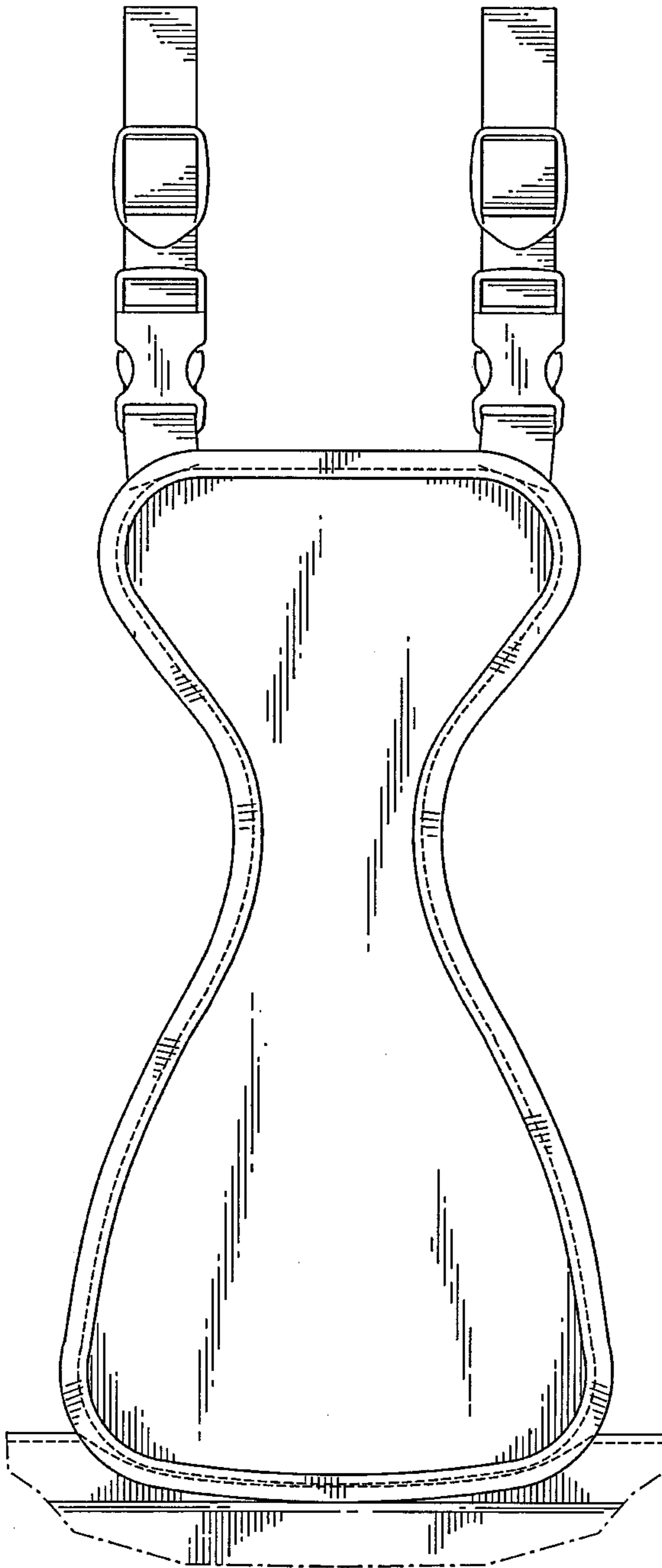

FIG. 1

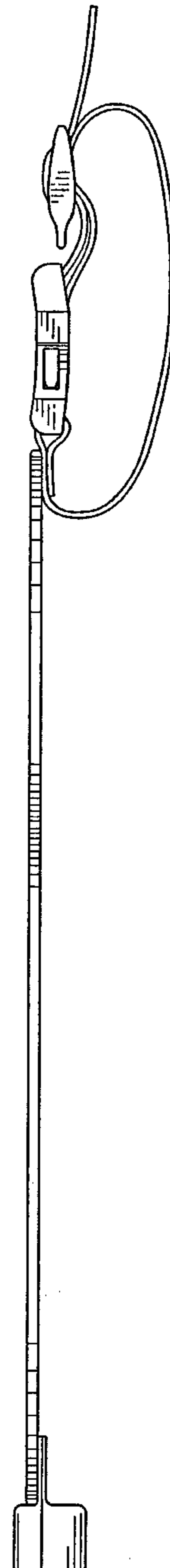

FIG. 2

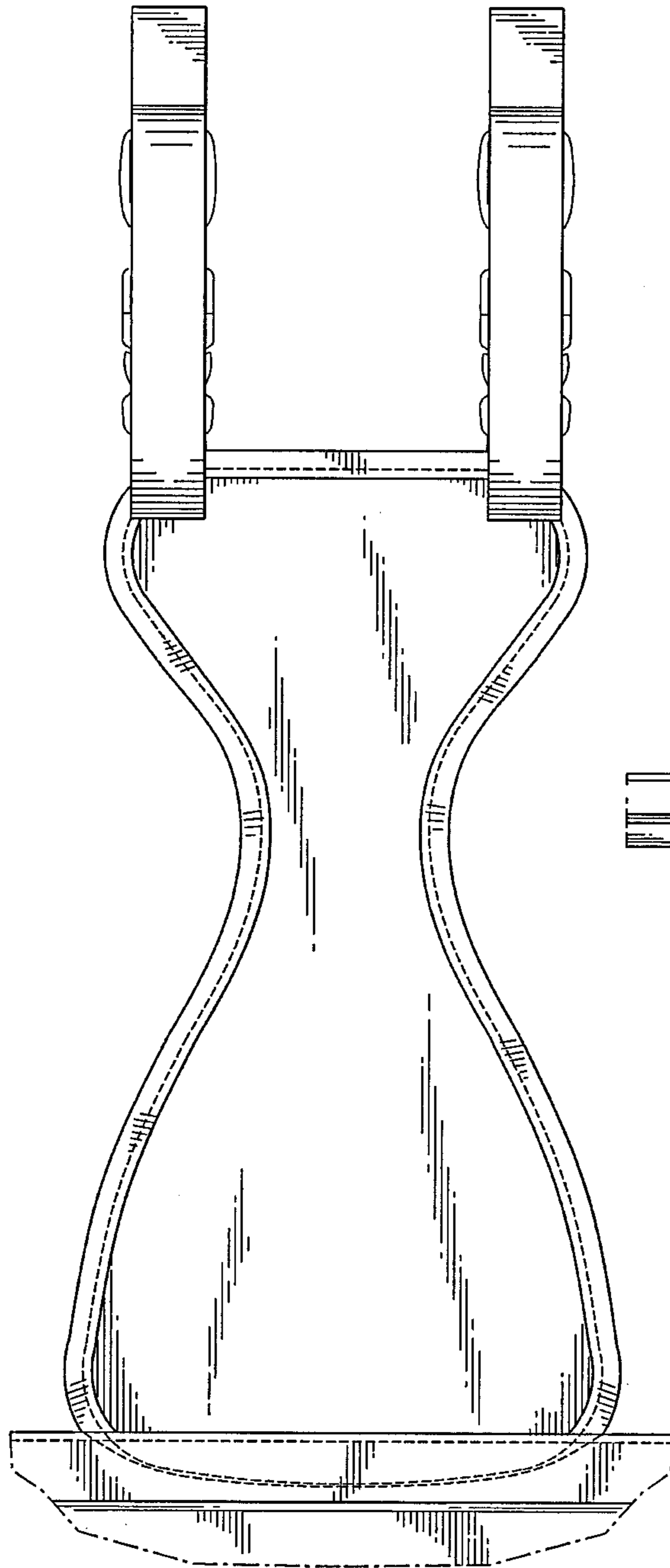

FIG.3

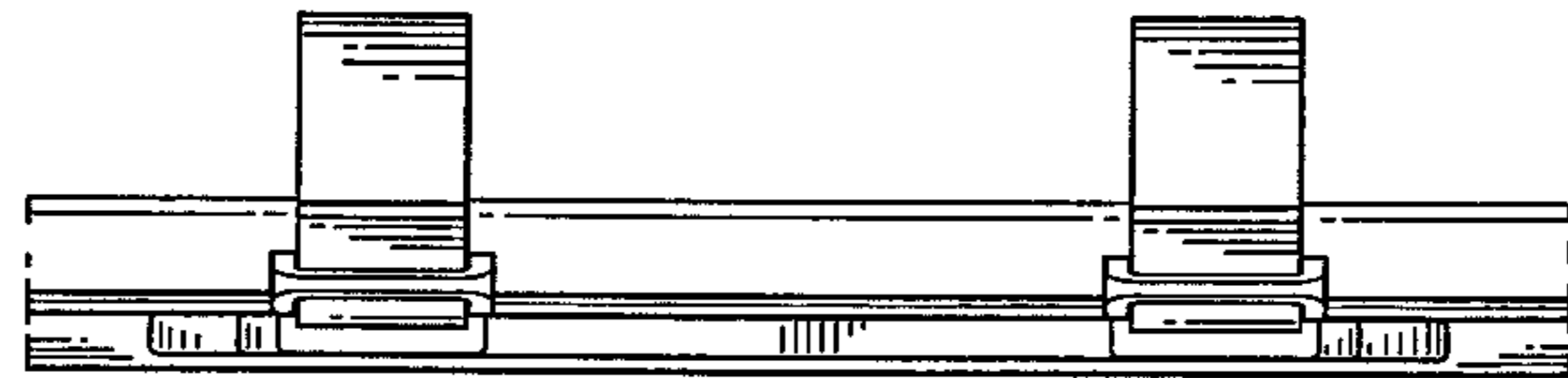

FIG.4

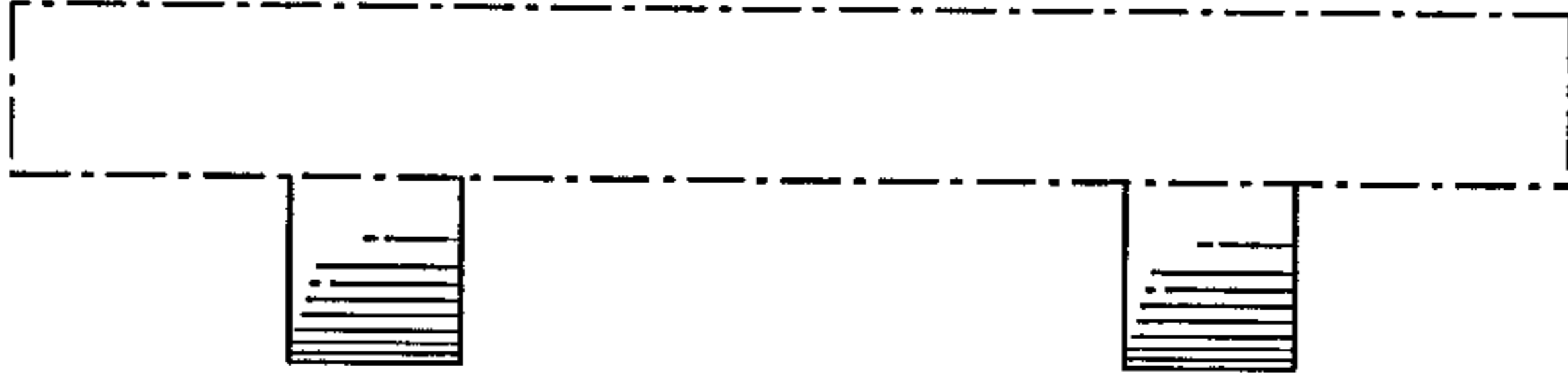

FIG.5

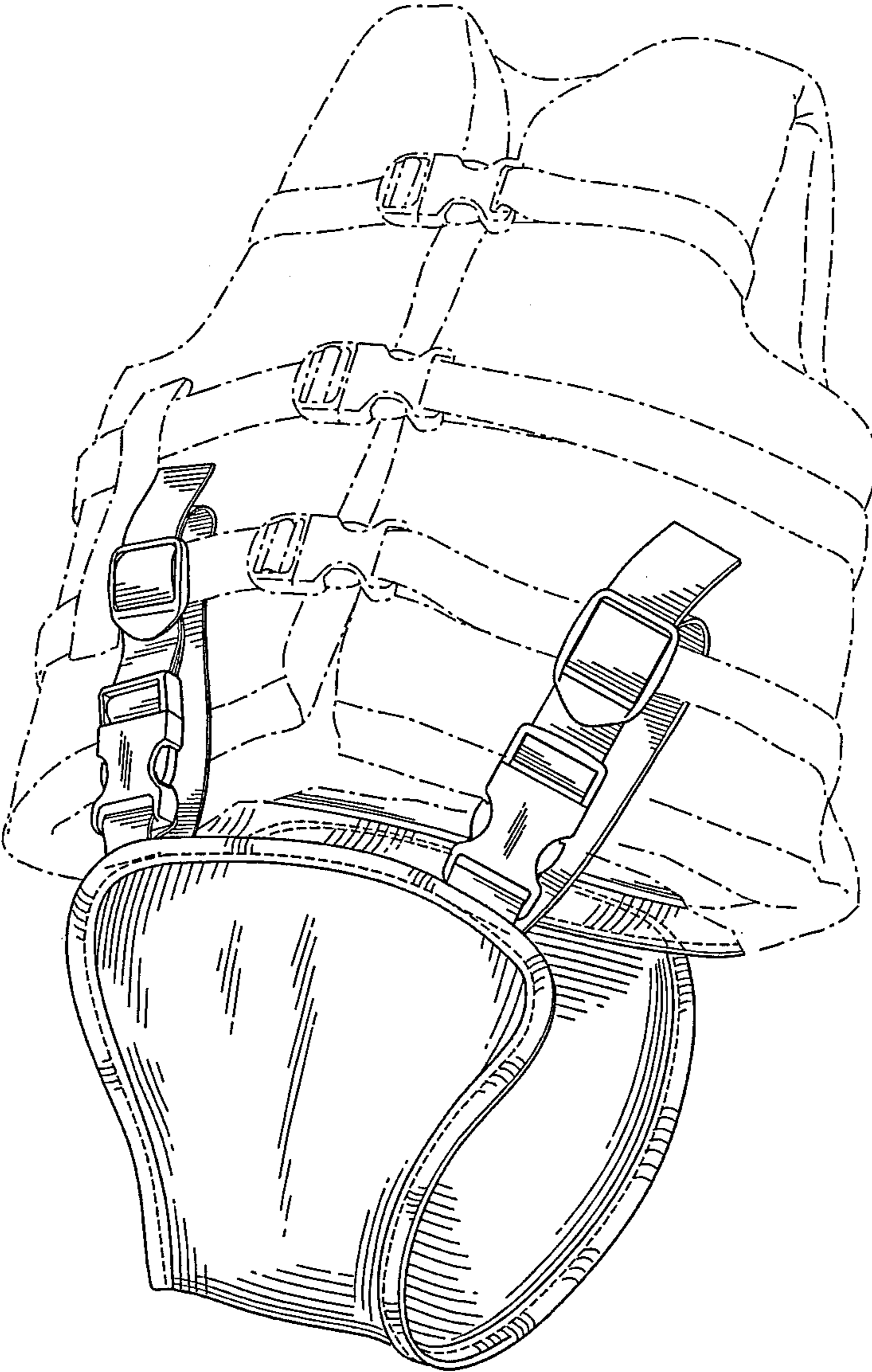

FIG.6

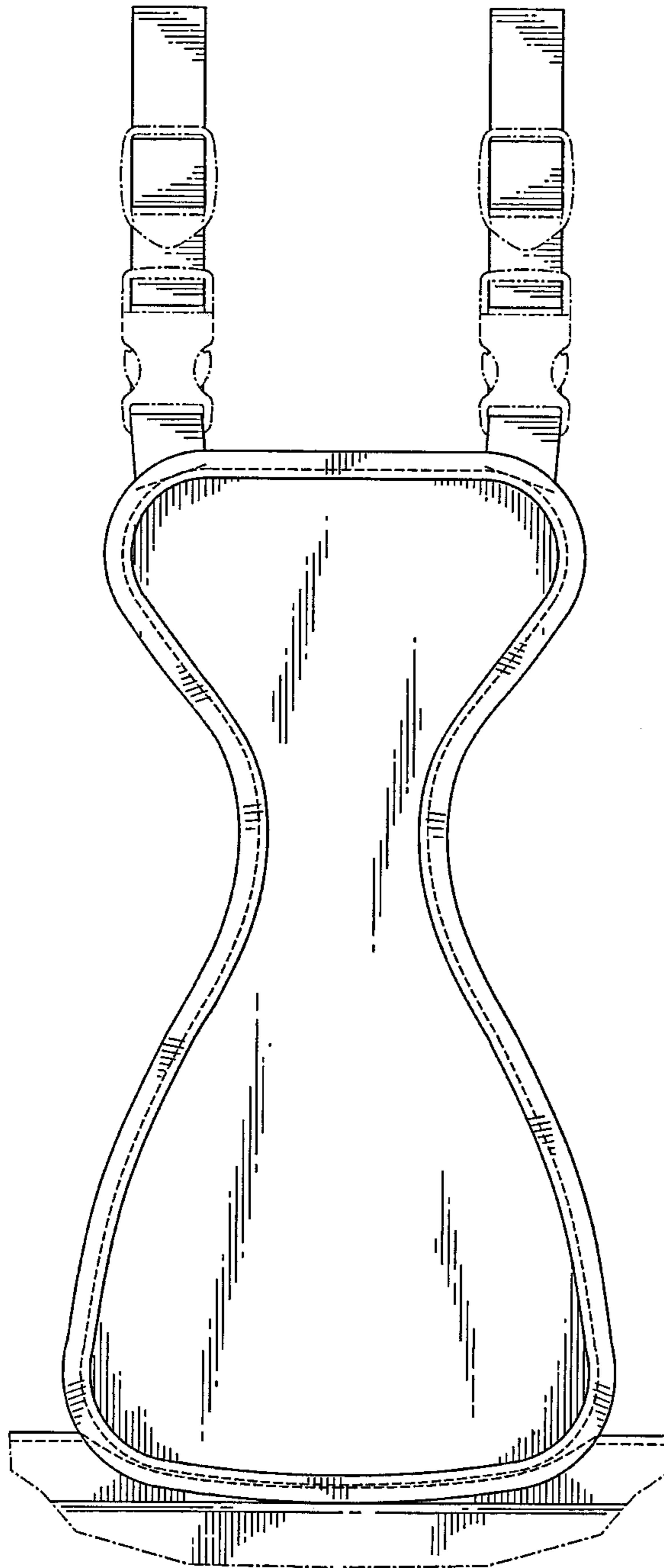

FIG. 7

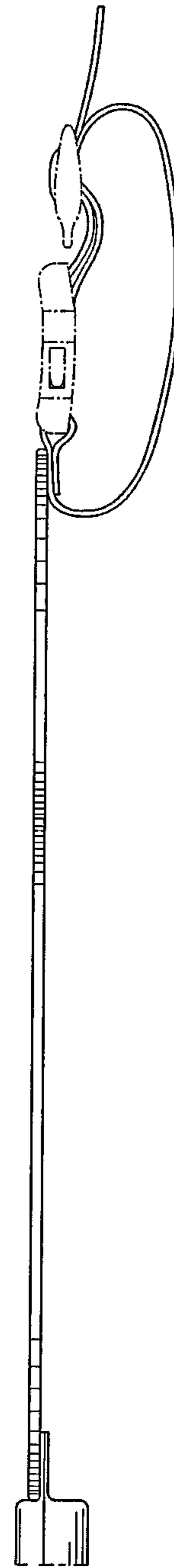

FIG. 8

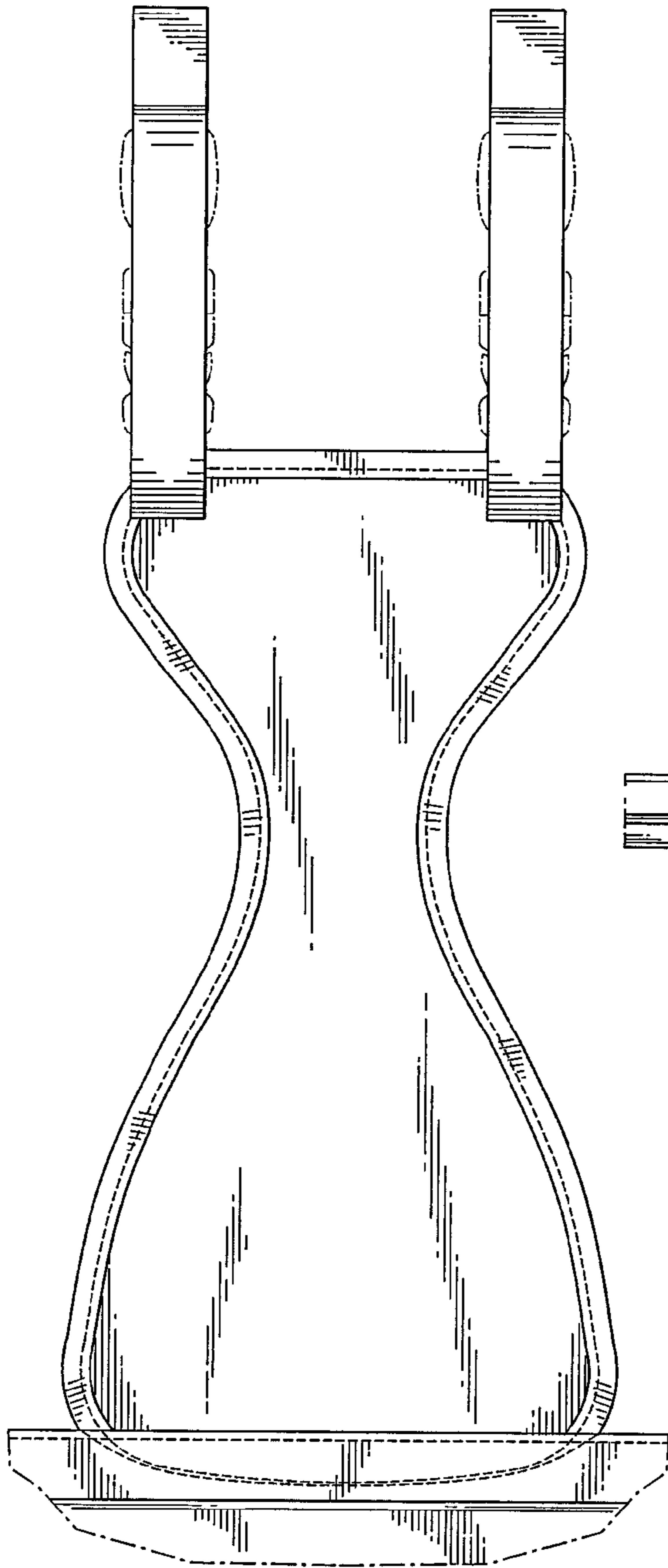

FIG. 9

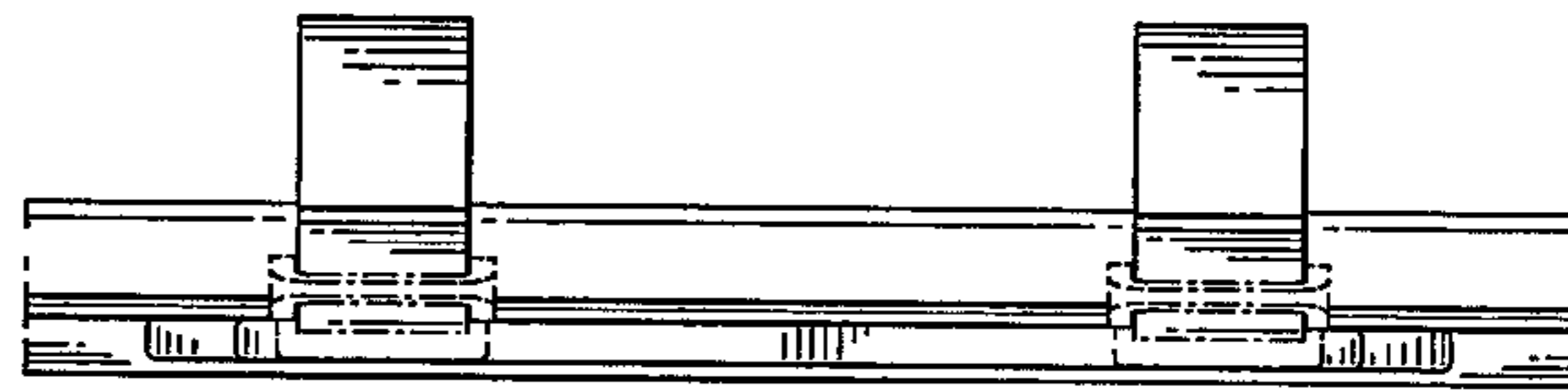

FIG. 10

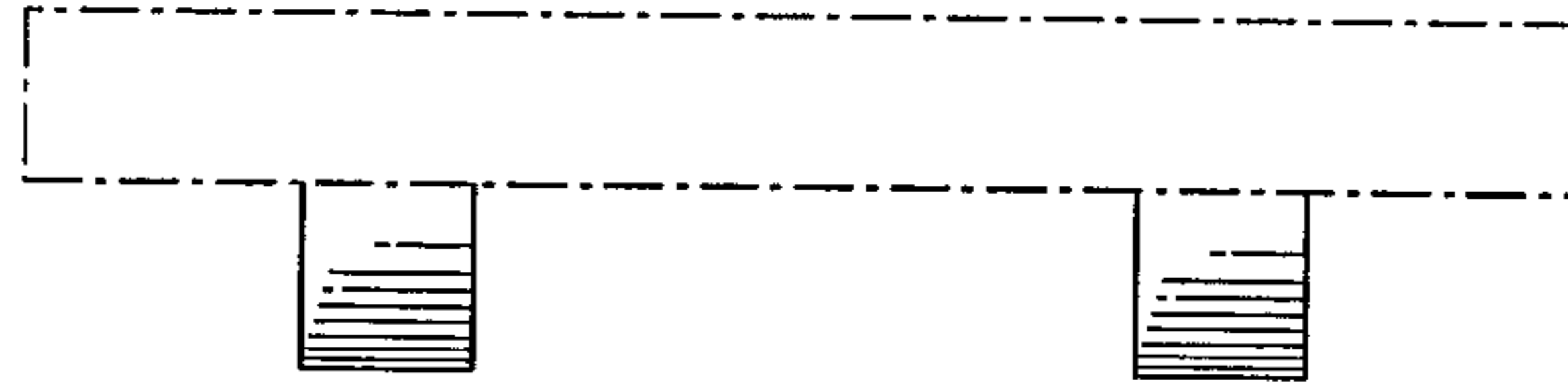

FIG.11

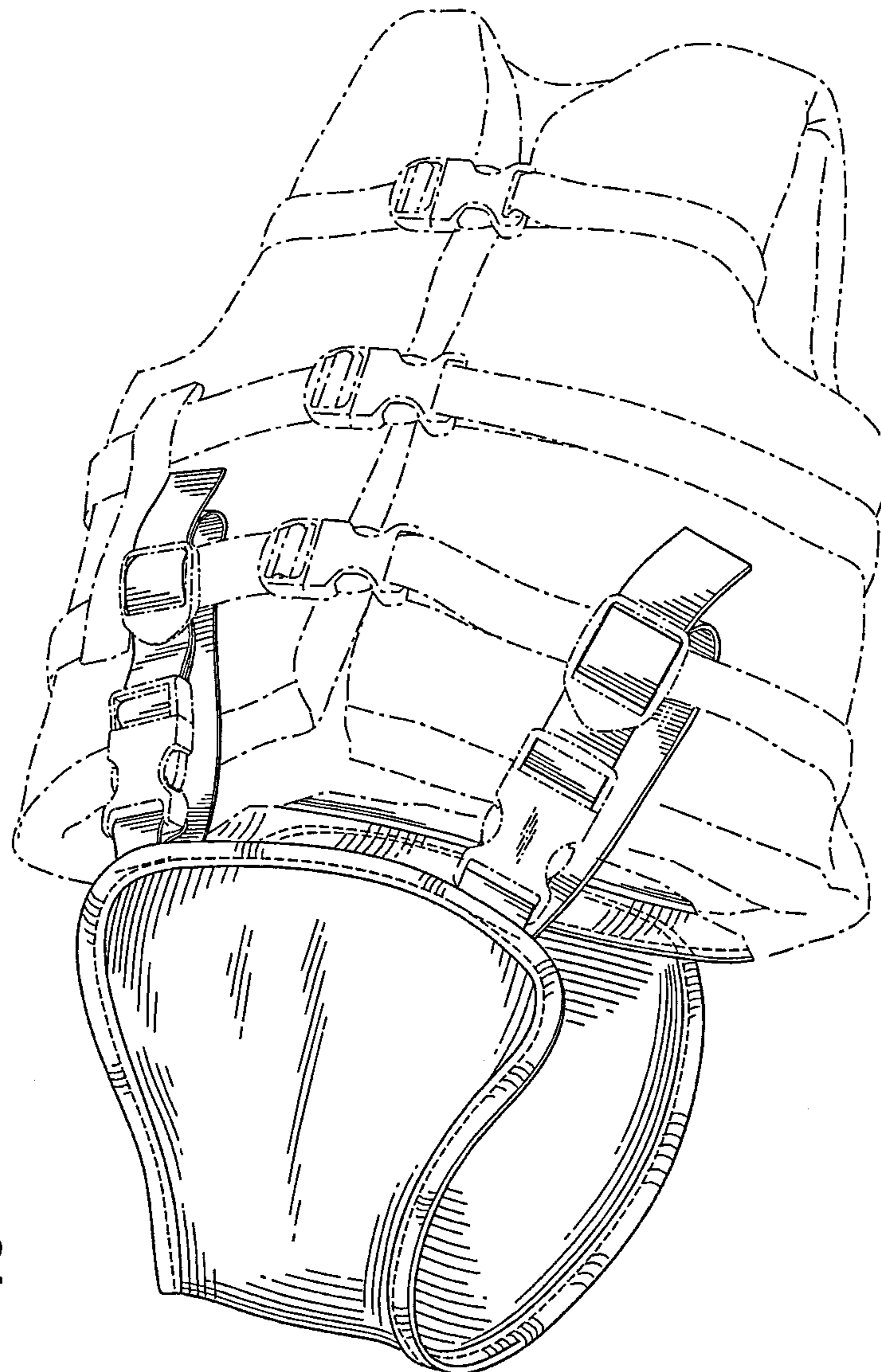

FIG.12