

US00D706350S

(12) **United States Design Patent**
Logue

(10) **Patent No.:** **US D706,350 S**
(45) **Date of Patent:** **** Jun. 3, 2014**

- (54) **VENDING MACHINE**
- (71) Applicant: **Logue & Co. Pty, as Trustee for A.T. & L.M. Logue Family Trust, Yowie Bay (AU)**
- (72) Inventor: **Anthony Thomas Logue, Yowie Bay (AU)**
- (73) Assignee: **Logue & Co. Pty, Yowie Bay, NSW (AU)**

- (**) Term: **14 Years**
- (21) Appl. No.: **29/456,785**
- (22) Filed: **Jun. 4, 2013**

- (30) **Foreign Application Priority Data**
- Dec. 21, 2012 (AU) 16652/2012
- Dec. 21, 2012 (AU) 16653/2012

- (51) **LOC (10) Cl.** **20-01**
- (52) **U.S. Cl.**
USPC **D20/1**

- (58) **Field of Classification Search**
USPC D20/1-9; 221/4, 6, 12, 13, 68, 87, 110, 221/123, 124, 149, 150 R, 150 HC, 150 A, 221/156, 159, 187, 190, 211, 213, 226, 231, 221/251, 279; D6/407, 513-515, 517, 520, D6/540; D7/300, 306-312; D9/415, 433, D9/733; D99/28; 194/236, 239, 350; 206/526; 211/59.2; 222/129, 135, 222/144.5, 181.2, 185.1; 312/9.21, 34.22, 312/45

See application file for complete search history.

- (56) **References Cited**
U.S. PATENT DOCUMENTS

2,996,344 A * 8/1961 Garman 312/45

3,529,877 A *	9/1970	Cassidy	312/34.22
D403,576 S *	1/1999	Weiss	D9/734
6,390,337 B1 *	5/2002	Shea	222/181.2
D458,782 S *	6/2002	Shea	D6/513
D471,044 S *	3/2003	Shea	D6/514
D475,227 S *	6/2003	Clarke	D6/520
D545,098 S *	6/2007	Wolfson	D6/520
D640,077 S *	6/2011	Jensen et al.	D6/517
D667,661 S *	9/2012	Norton	D6/520
2001/0010315 A1 *	8/2001	Tomioka	221/155
2013/0037561 A1 *	2/2013	Wolpow	221/124

* cited by examiner

Primary Examiner — Mary Ann Calabrese
(74) *Attorney, Agent, or Firm* — Sughrue Mion, PLLC

(57) **CLAIM**
The ornamental design for a vending machine, as shown and described.

DESCRIPTION

FIG. 1 is a front perspective view of a first embodiment of my design;
 FIG. 2 is a front view thereof;
 FIG. 3 is rear view thereof;
 FIG. 4 is right side view thereof;
 FIG. 5 is left side view thereof;
 FIG. 6 is top view thereof;
 FIG. 7 is bottom view thereof;
 FIG. 8 is a front perspective view of a second embodiment of my design;
 FIG. 9 is a front view thereof;
 FIG. 10 is rear view thereof;
 FIG. 11 is right side view thereof;
 FIG. 12 is left side view thereof;
 FIG. 13 is top view thereof; and,
 FIG. 14 is bottom view thereof.

The features shown in broken lines shown environment only and form no part of the claimed design.

1 Claim, 8 Drawing Sheets

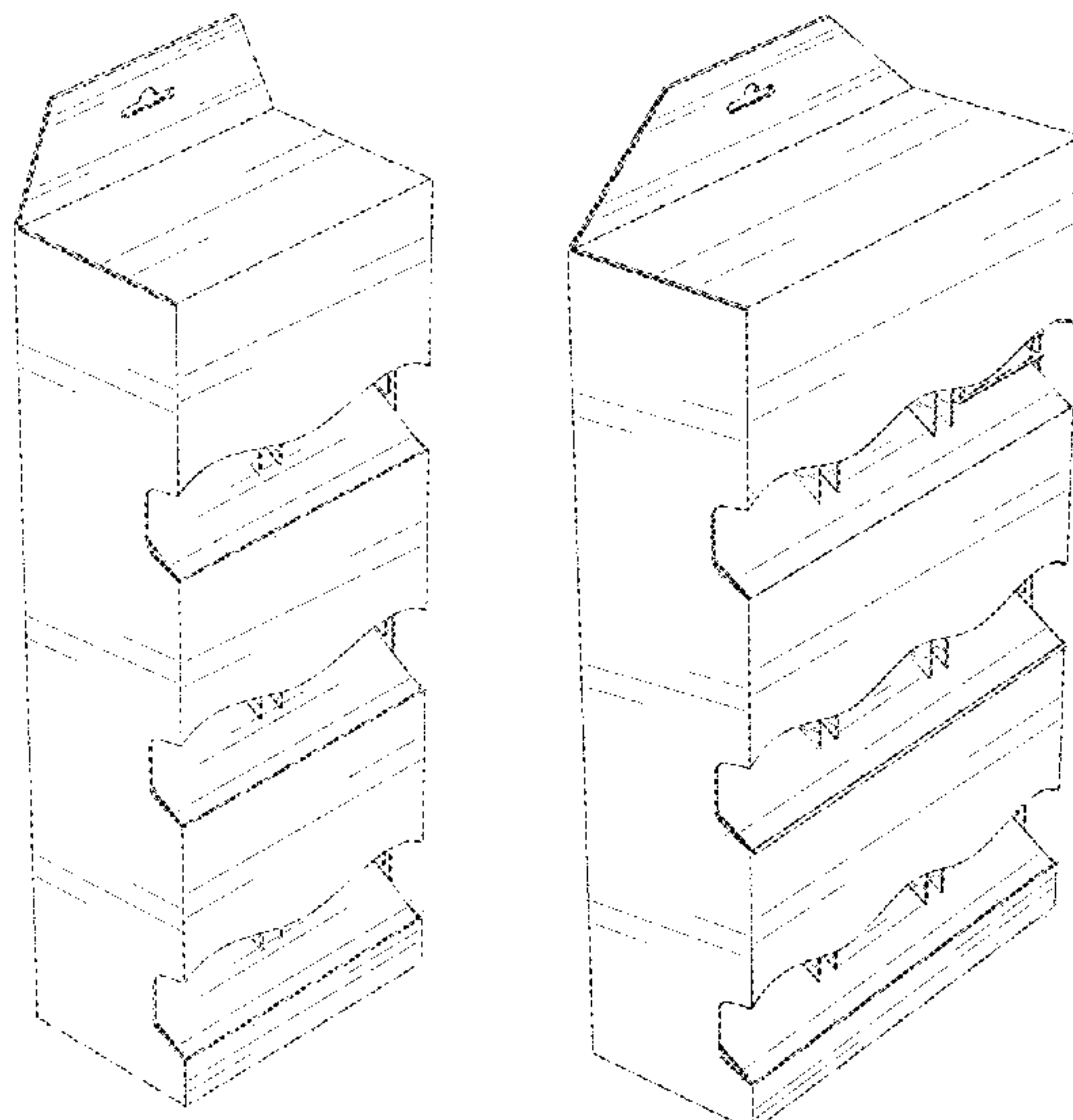

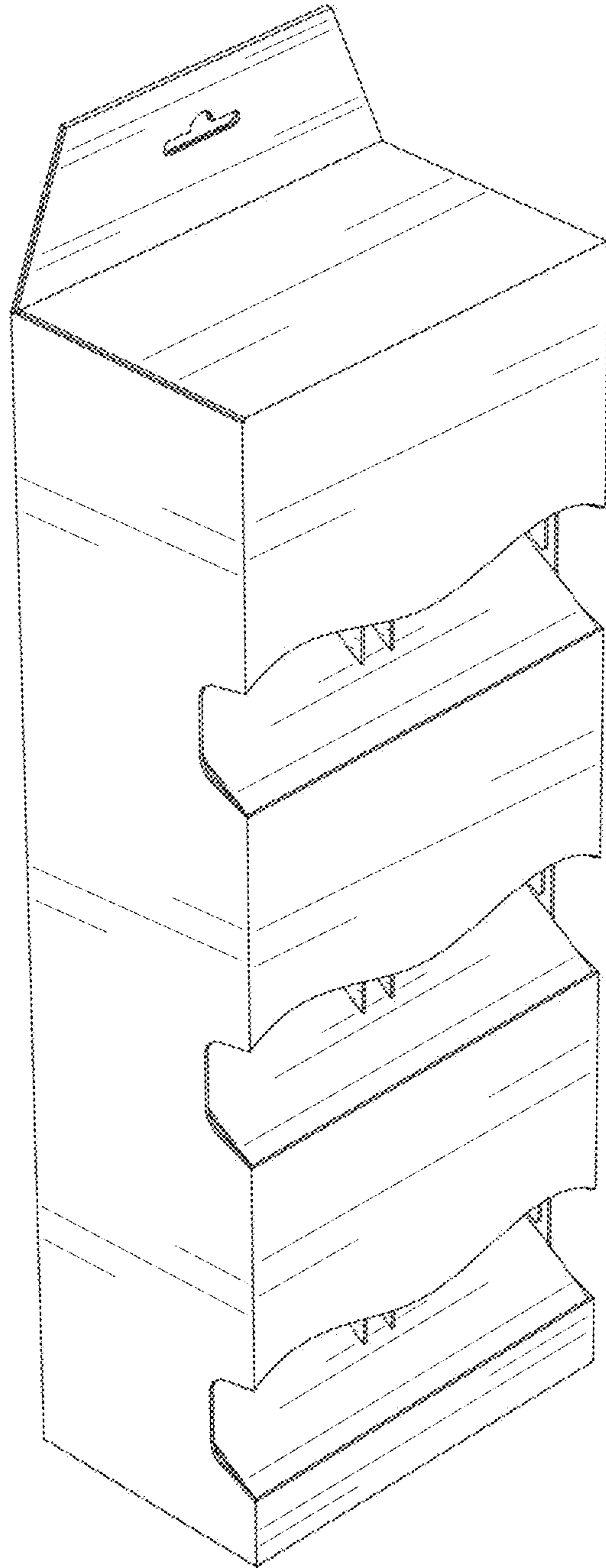

FIG. 1

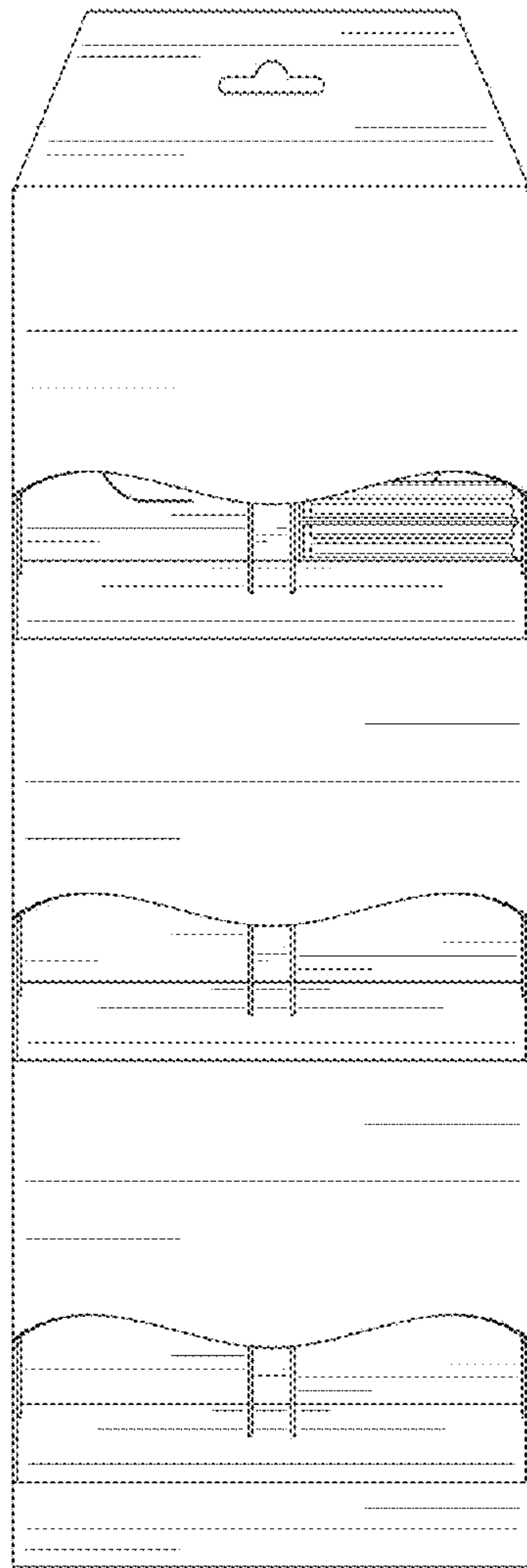

FIG. 2

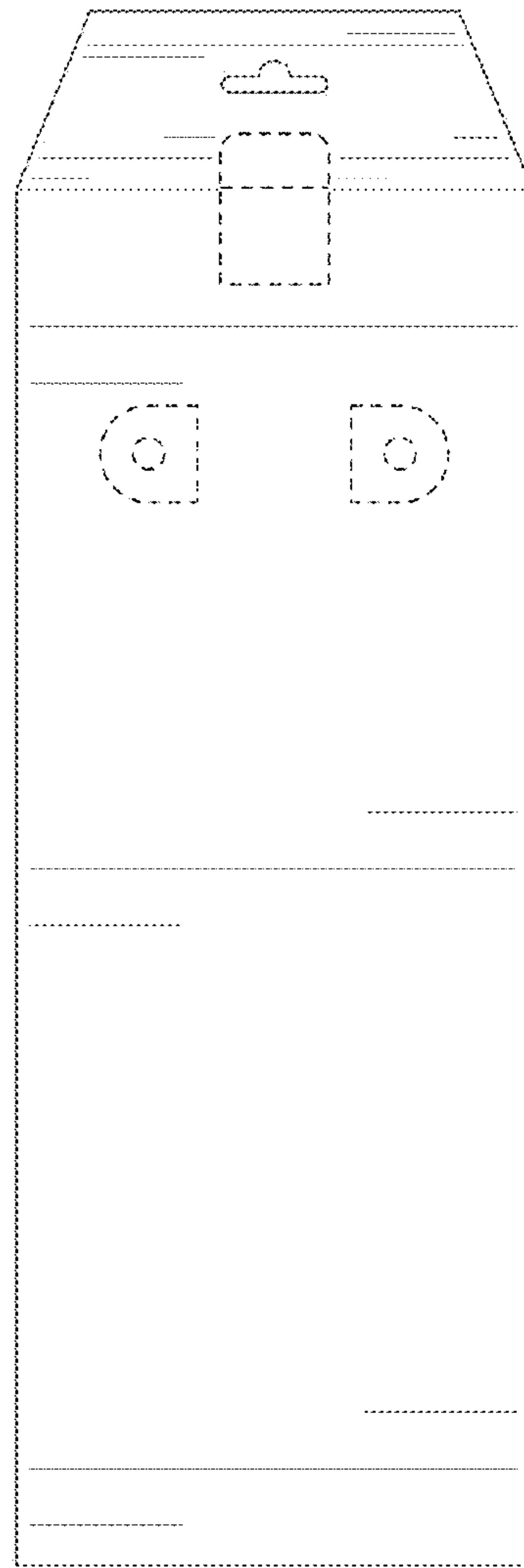

FIG. 3

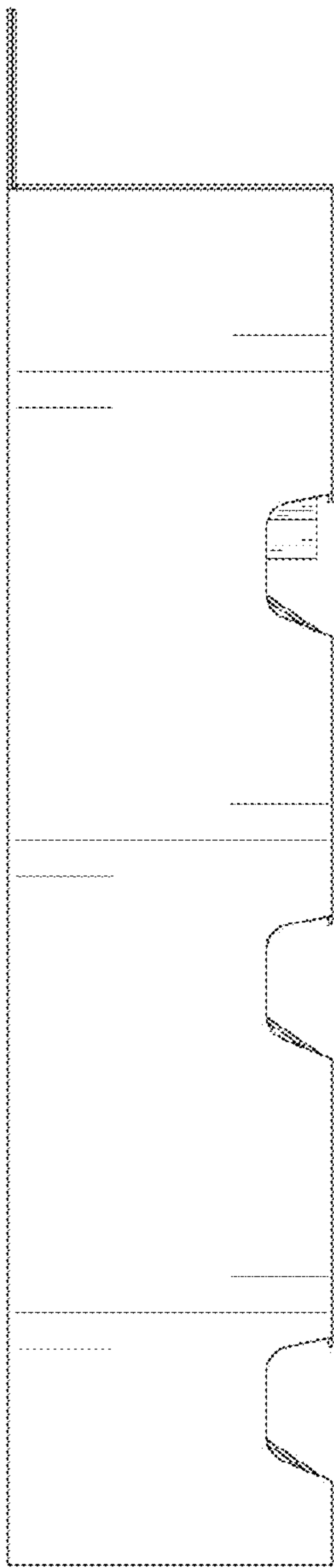

FIG. 4

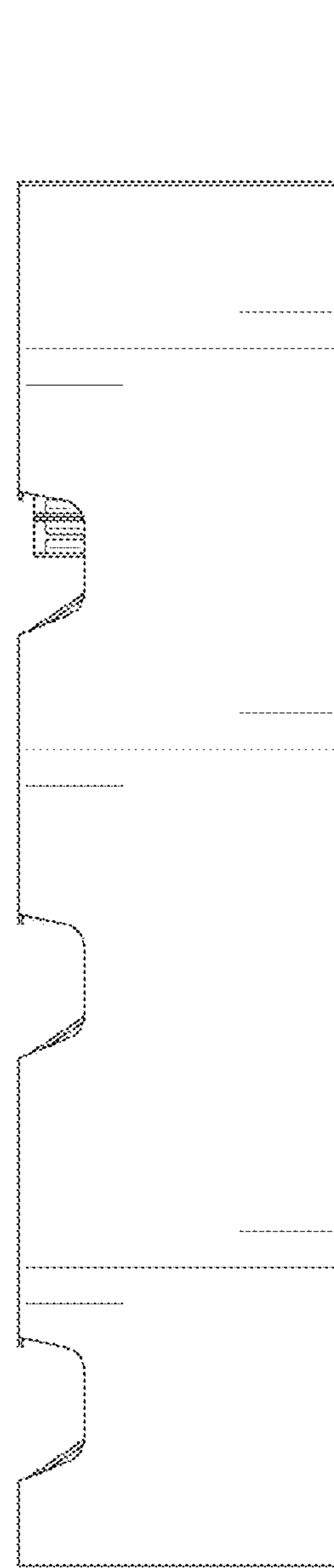

FIG. 5

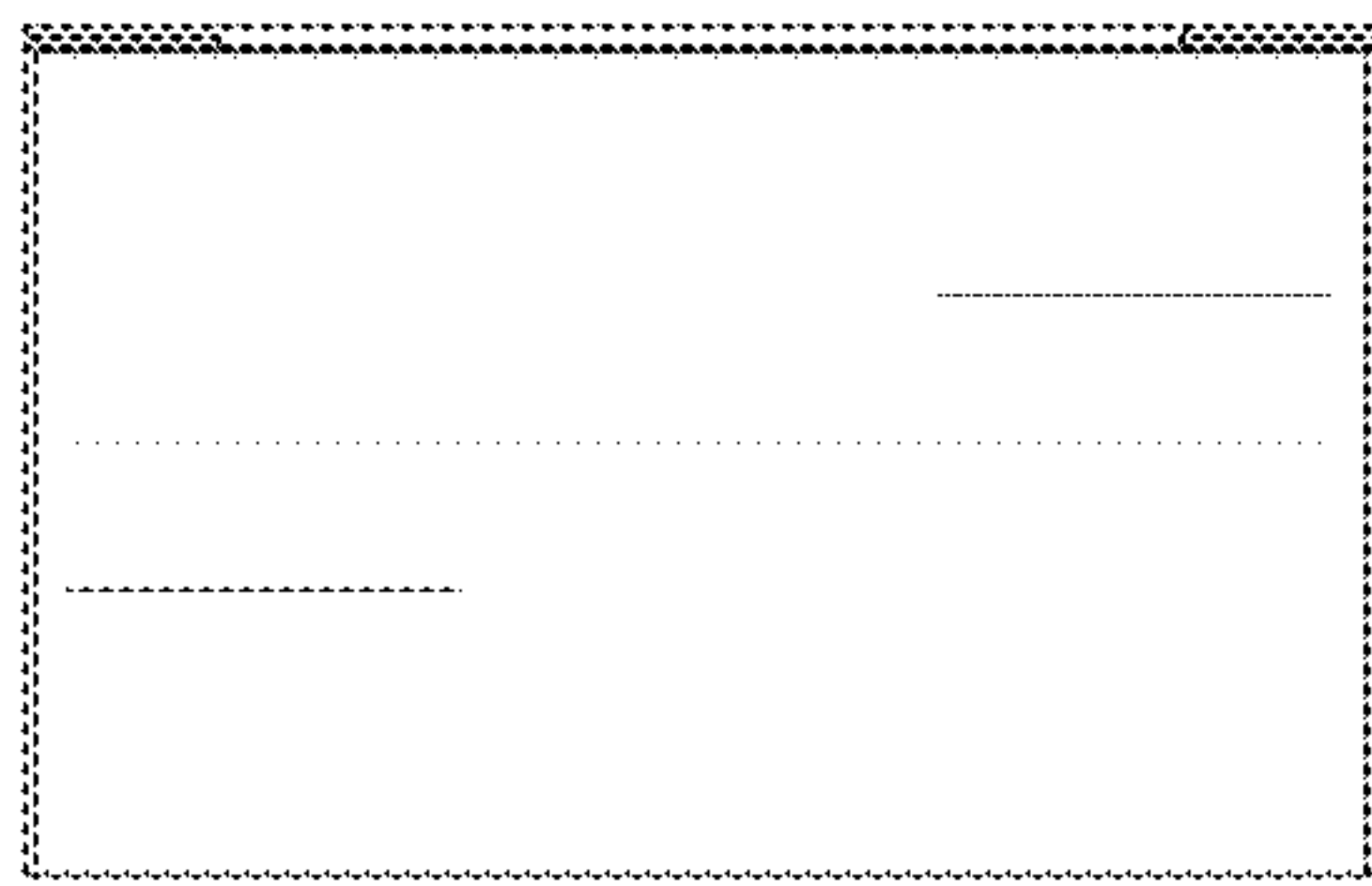

FIG. 6

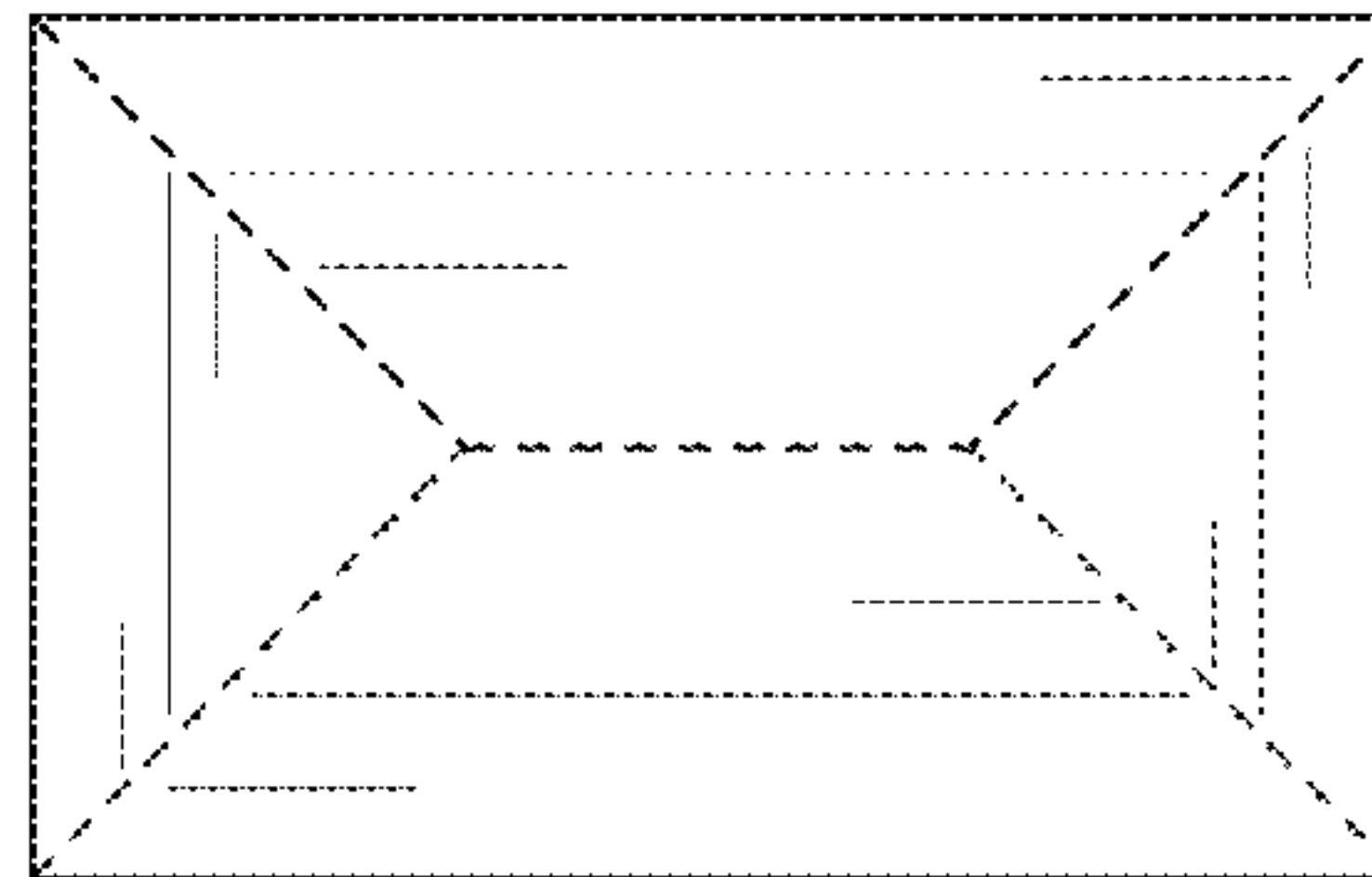

FIG. 7

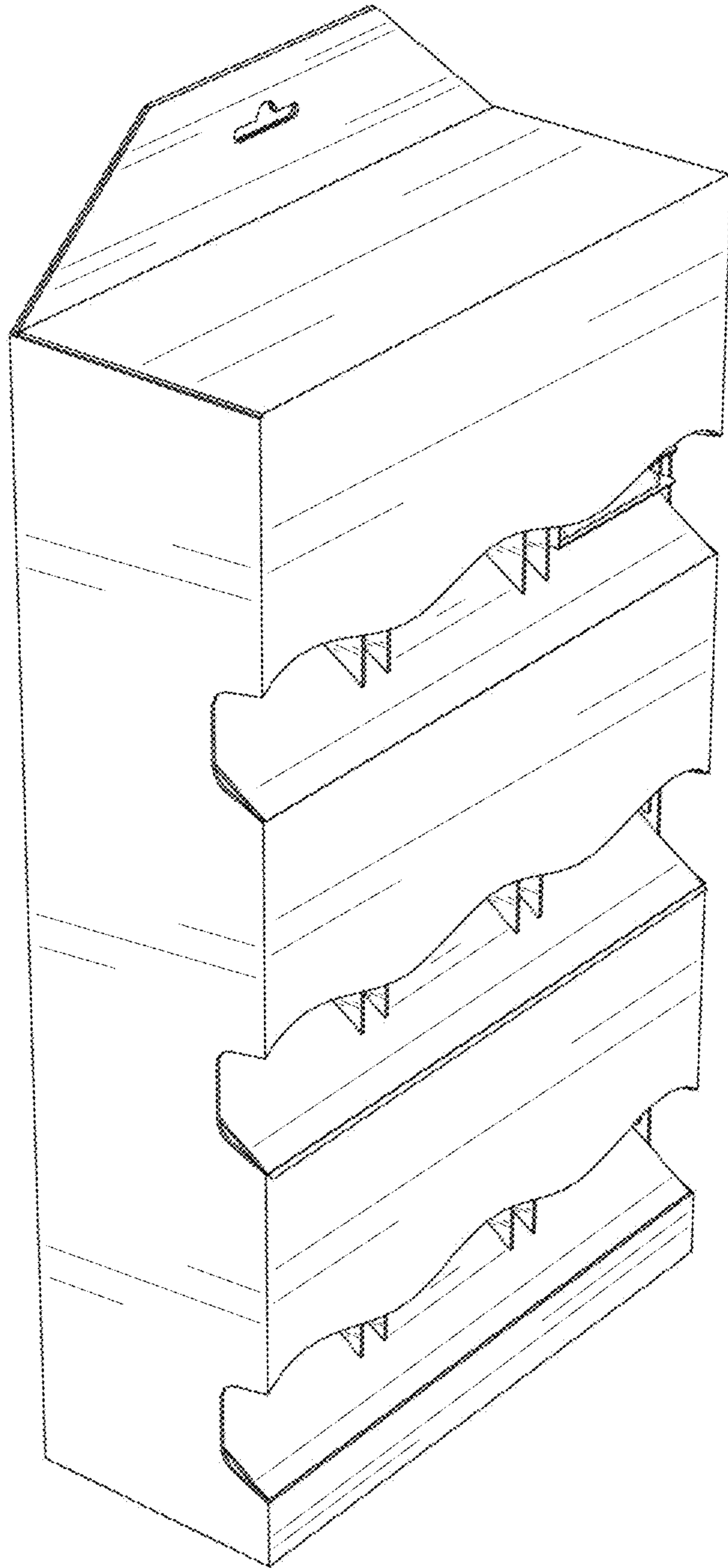

FIG. 8

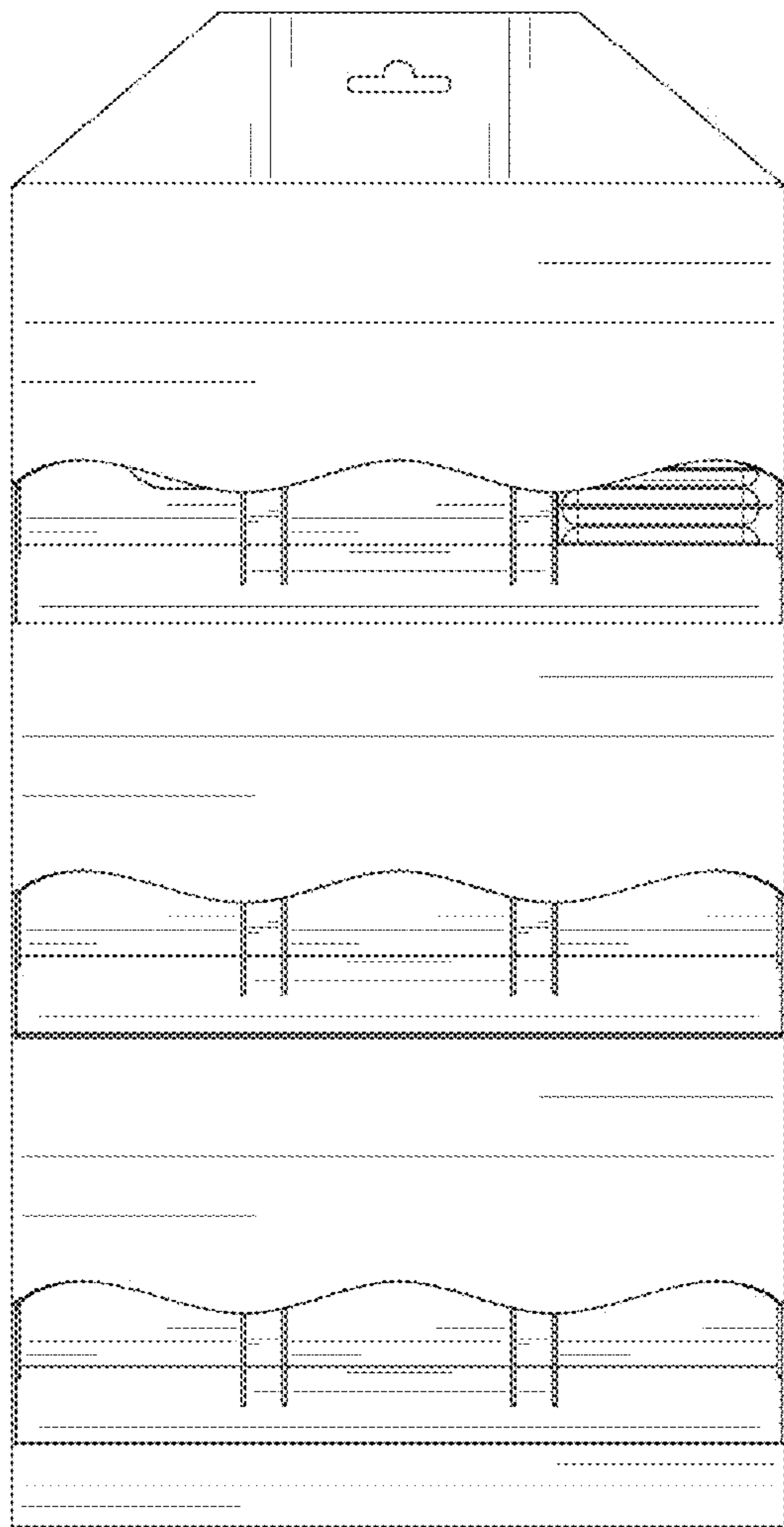

FIG. 9

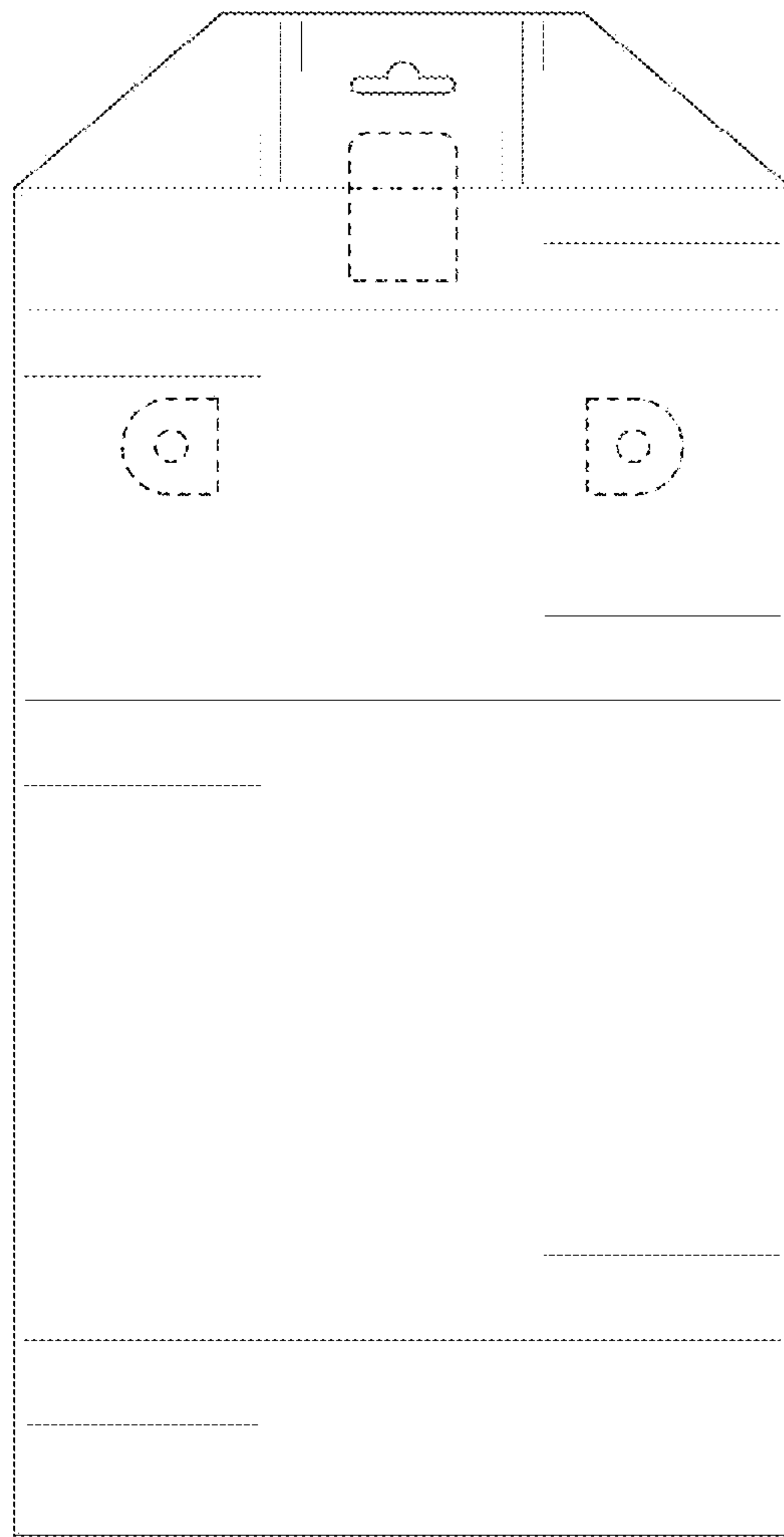

FIG. 10

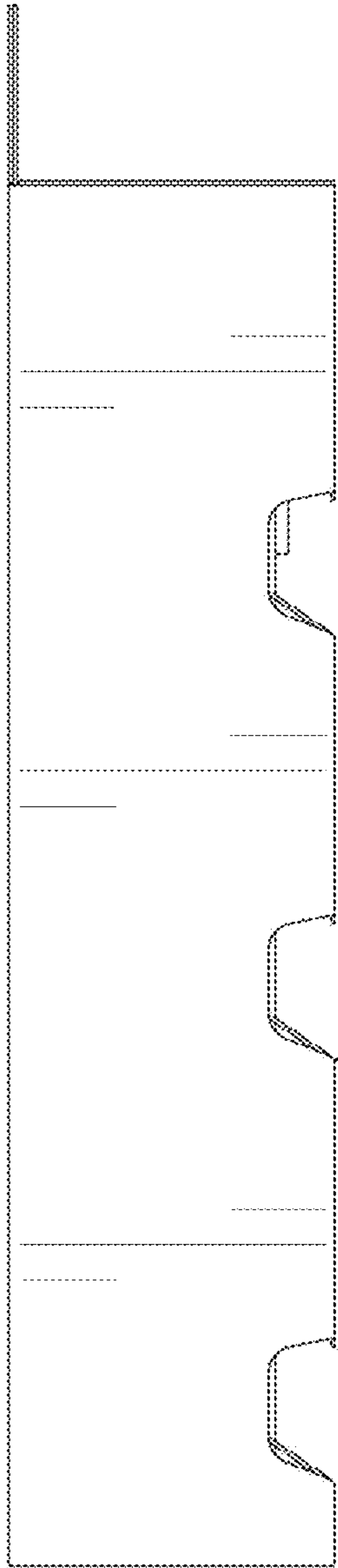

FIG. 11

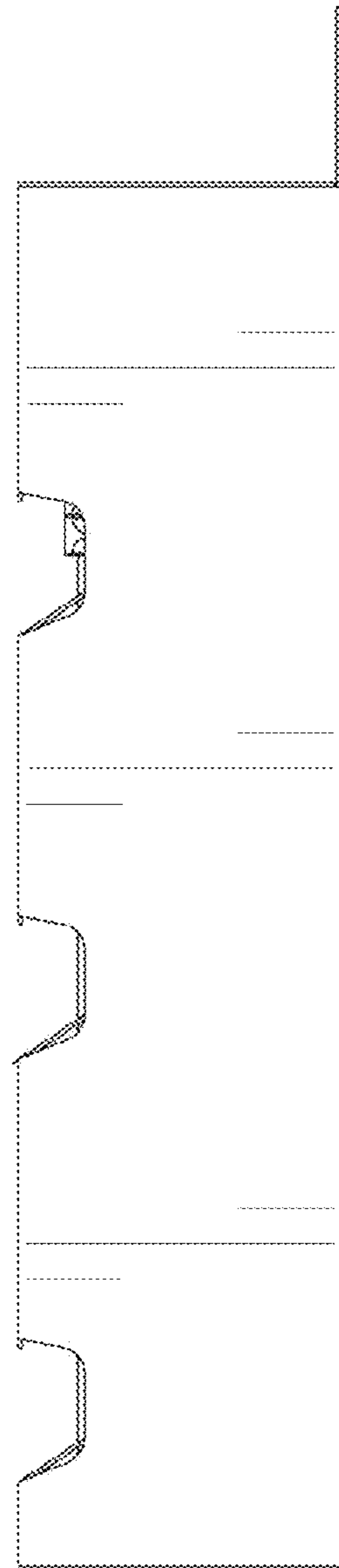

FIG. 12

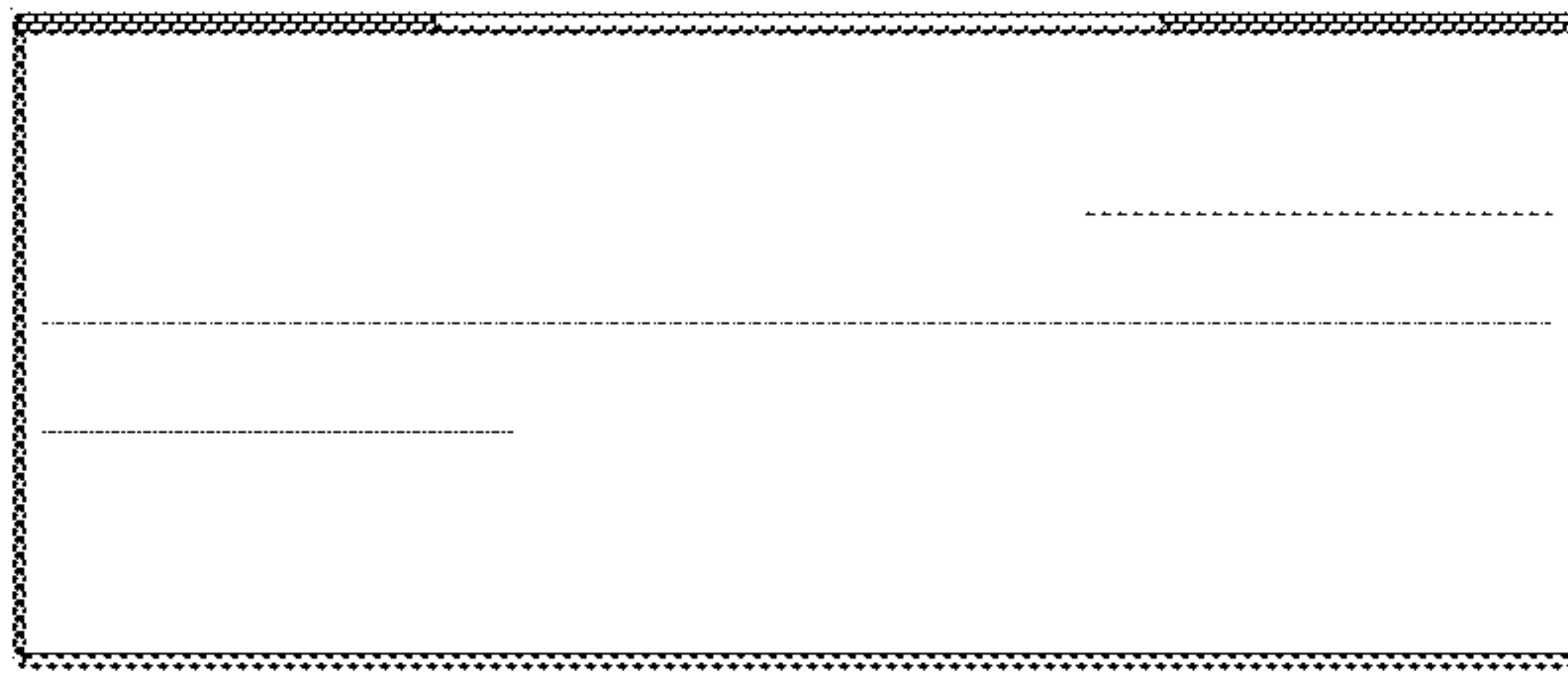

FIG. 13

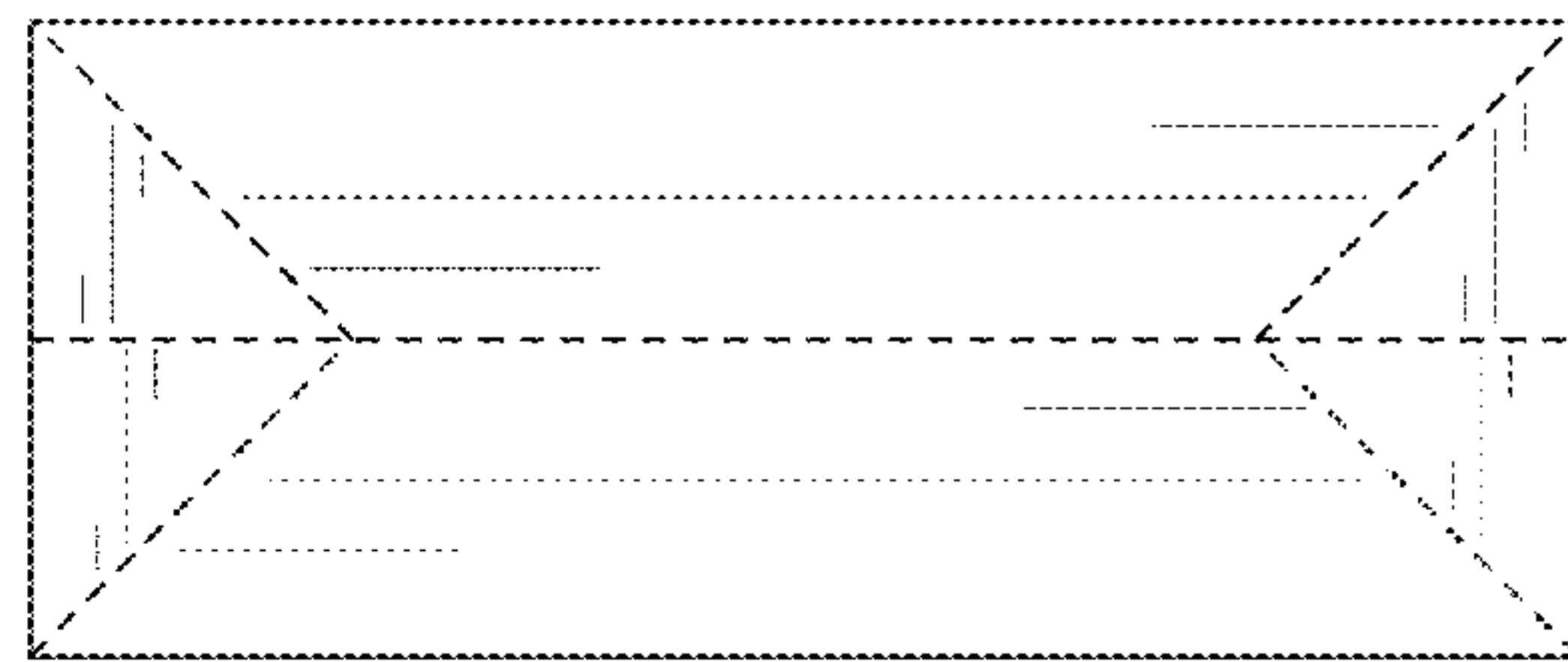

FIG. 14