



US00D706349S

(12) **United States Design Patent**  
**Logue**

(10) **Patent No.:** **US D706,349 S**  
(45) **Date of Patent:** **\*\* Jun. 3, 2014**

(54) **VENDING MACHINE**

(56) **References Cited**

(71) Applicant: **Logue and Co. Pty Ltd.**, Yowie Bay (AU)

U.S. PATENT DOCUMENTS

(72) Inventor: **Anthony Thomas Logue**, Yowie Bay (AU)

2,996,344 A *	8/1961	Garman	312/45
3,529,877 A *	9/1970	Cassidy	312/34.22
D403,576 S *	1/1999	Weiss	D9/734
6,390,337 B1 *	5/2002	Shea	222/181.2
D458,782 S *	6/2002	Shea	D6/513
D471,044 S *	3/2003	Shea	D6/514
D475,227 S *	6/2003	Clarke	D6/520
D545,098 S *	6/2007	Wolfson	D6/520
D640,077 S *	6/2011	Jensen et al.	D6/517
D667,661 S *	9/2012	Norton	D6/520
2001/0010315 A1 *	8/2001	Tomioaka	221/155
2013/0037561 A1 *	2/2013	Wolpow	221/124

(73) Assignee: **Logue and Co. Pty.**, Yowie Bay, NSW (AU)

(\*\*) Term: **14 Years**

\* cited by examiner

(21) Appl. No.: **29/447,499**

(22) Filed: **Mar. 4, 2013**

*Primary Examiner* — Mary Ann Calabrese

(30) **Foreign Application Priority Data**

(74) *Attorney, Agent, or Firm* — Sughrue Mion, PLLC

Sep. 10, 2012 (AU) ..... 14499/2012

(51) **LOC (10) Cl.** ..... **20-01**

(57) **CLAIM**

The ornamental design for a vending machine, as shown and described.

(52) **U.S. Cl.**

USPC ..... **D20/1**

**DESCRIPTION**

(58) **Field of Classification Search**

USPC ..... D20/1-9; 221/4, 6, 12, 13, 68, 87, 110, 221/123, 124, 149, 150 R, 150 HC, 150 A, 221/156, 159, 187, 190, 211, 213, 226, 231, 221/251, 279; D6/407, 513-515, 517, 520, D6/540; D7/300, 306-312; D9/415, 433, D9/733; D99/28; 194/236, 239, 350; 206/526; 211/59.2; 222/129, 135, 222/144.5, 181.2, 185.1; 312/9.21, 34.22, 312/45

FIG. 1 is a front perspective view of my design; FIG. 2 is a front view thereof; FIG. 3 is rear view thereof; FIG. 4 is right side view thereof; FIG. 5 is left side view thereof; FIG. 6 is top view thereof; and, FIG. 7 is bottom view thereof.

The features shown in broken lines shown environment only and form no part of the claimed design.

See application file for complete search history.

**1 Claim, 4 Drawing Sheets**

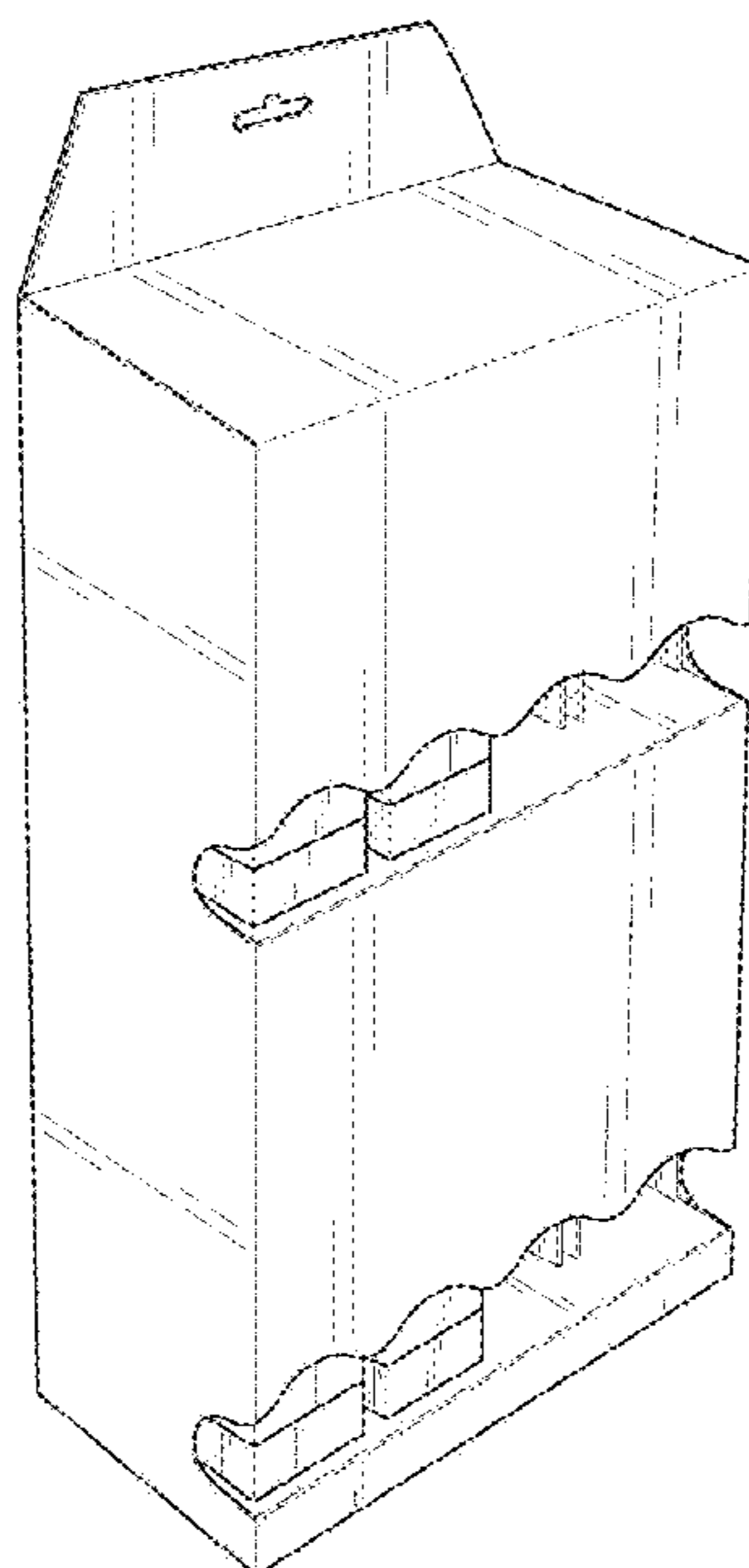

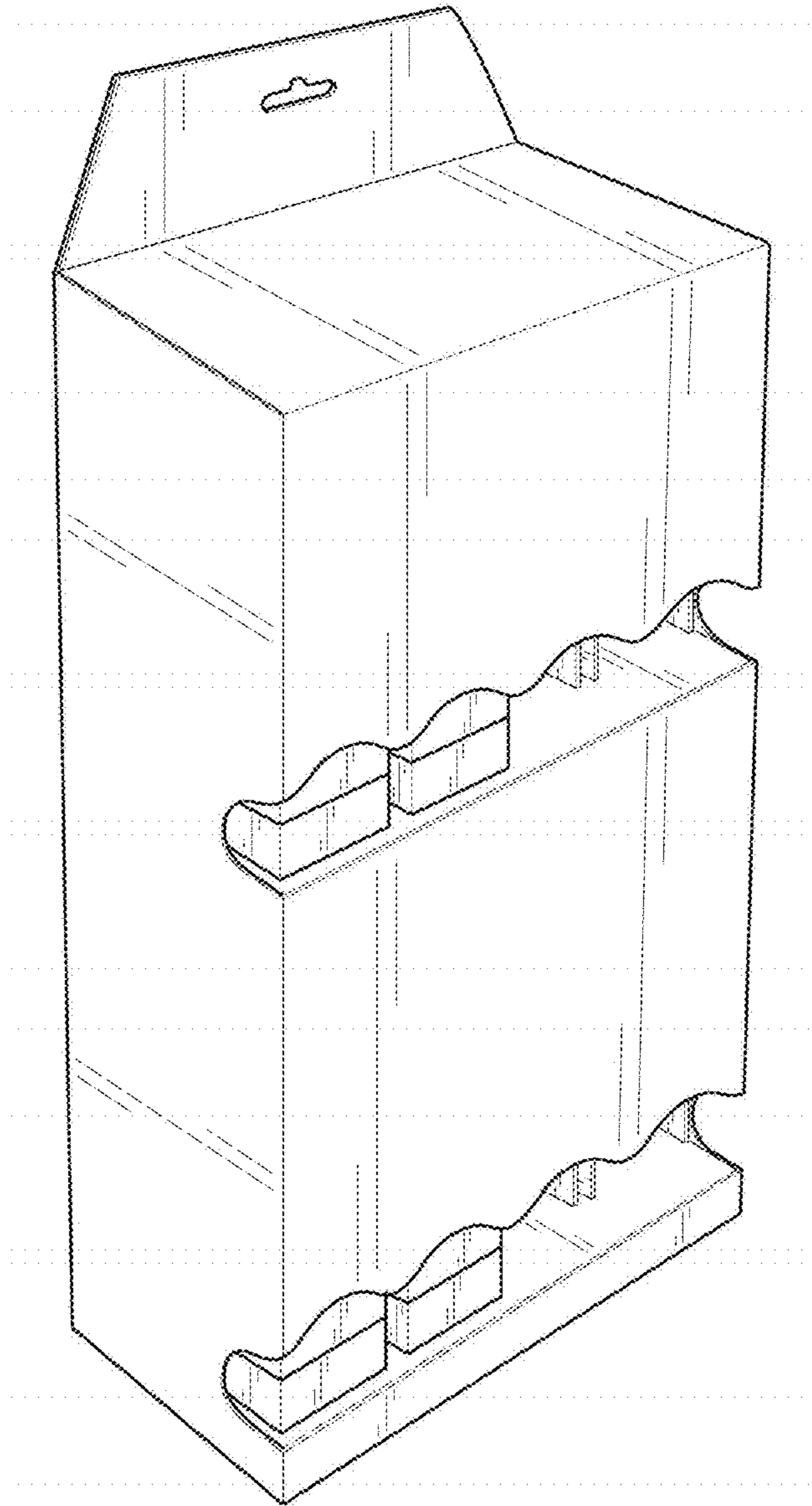

FIG. 1

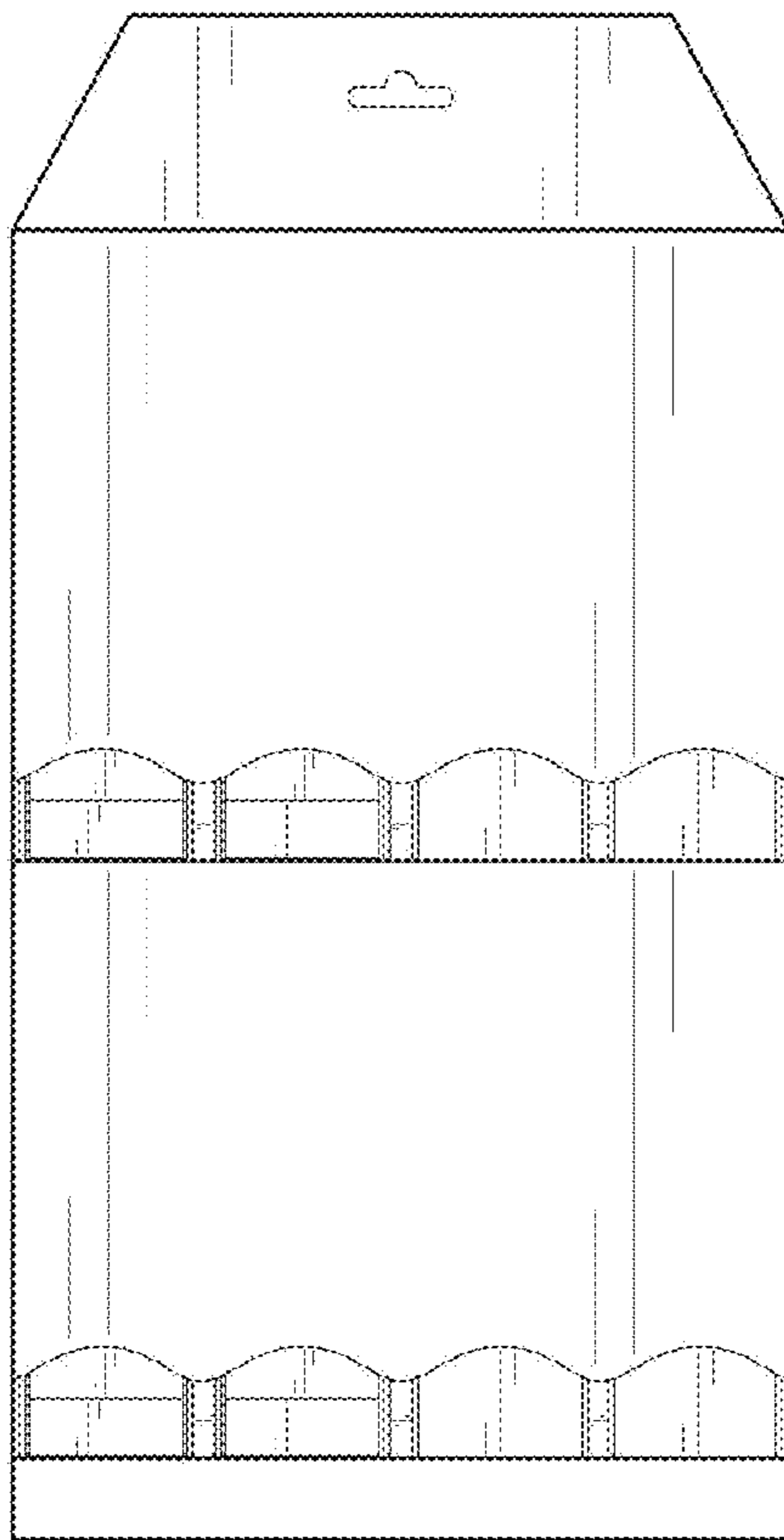

FIG. 2

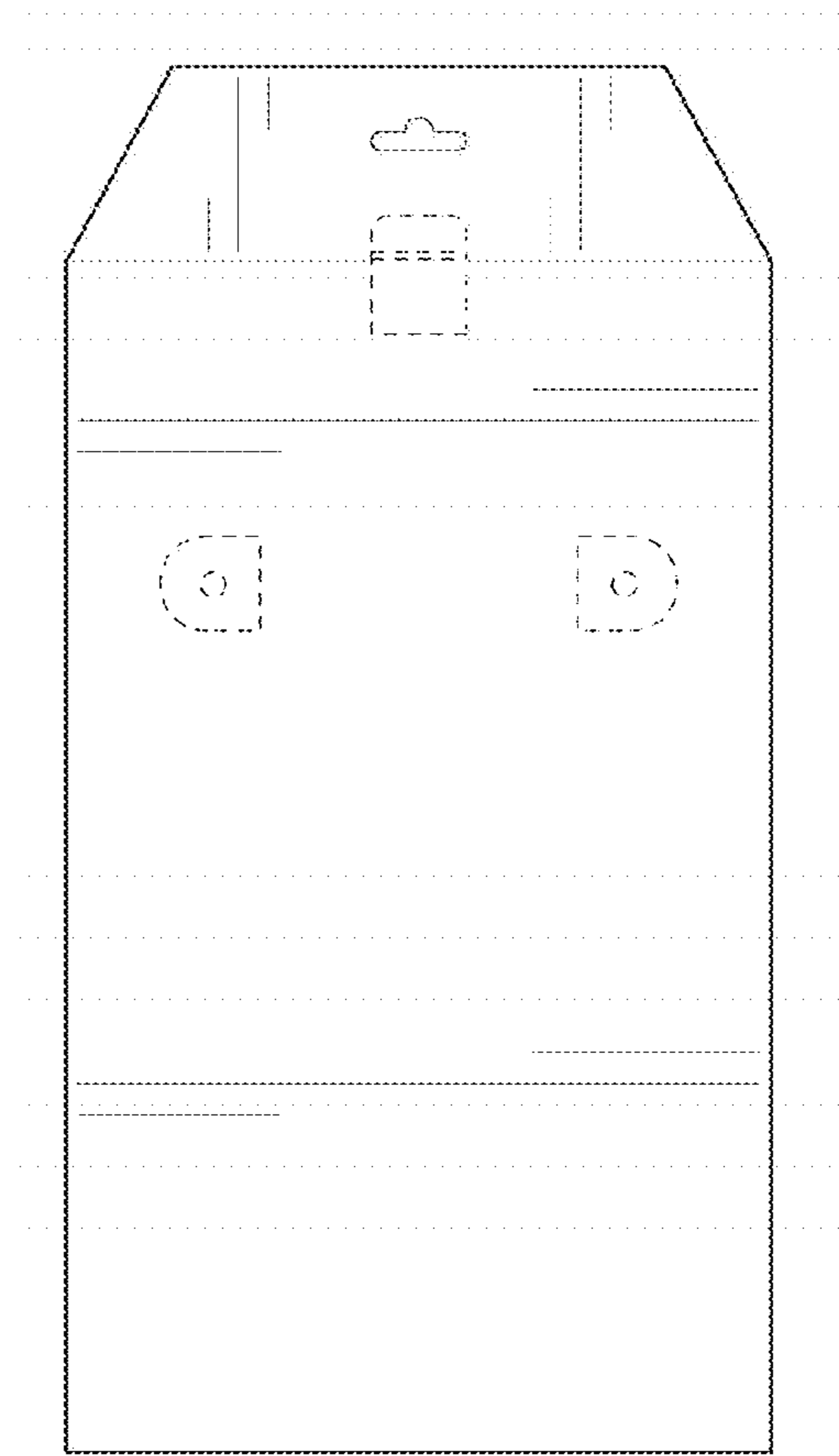

FIG. 3

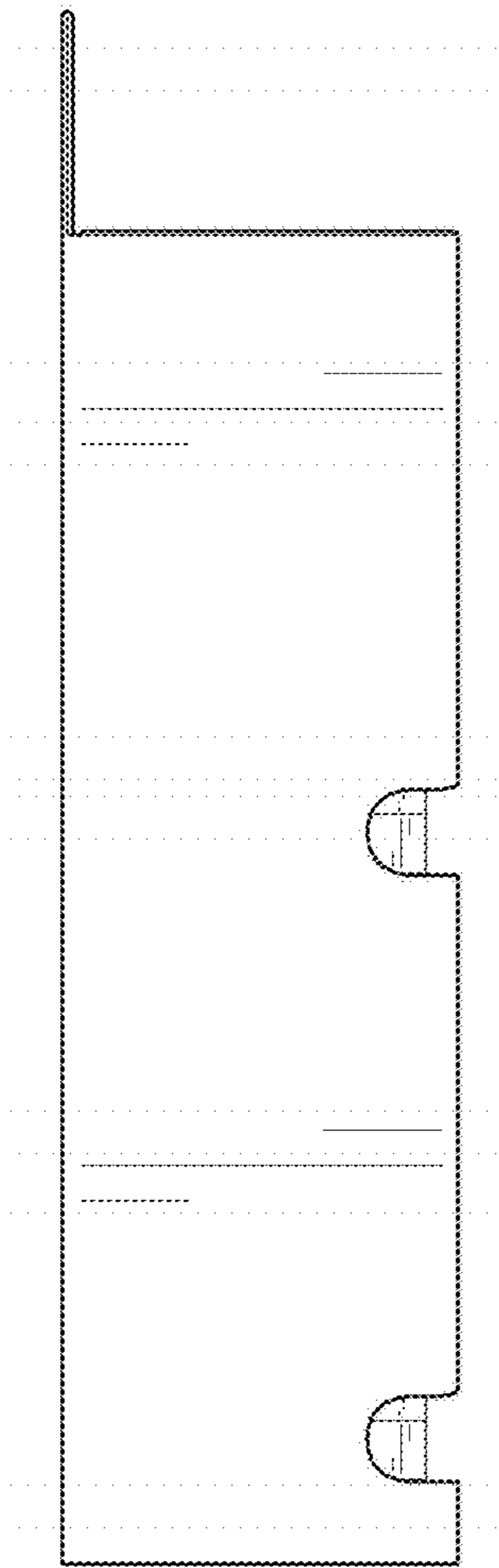

FIG. 4

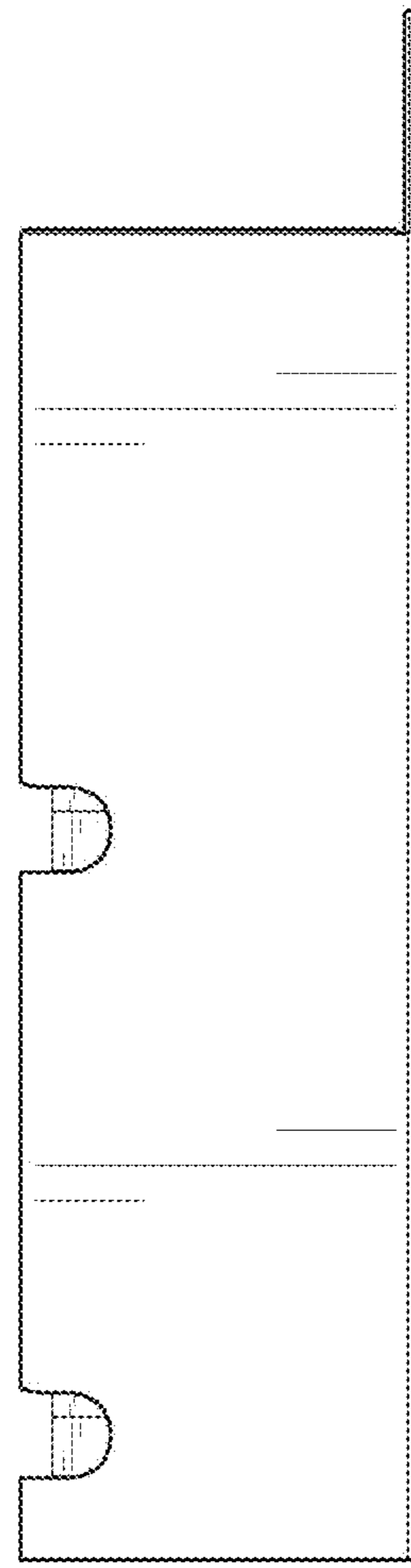

FIG. 5

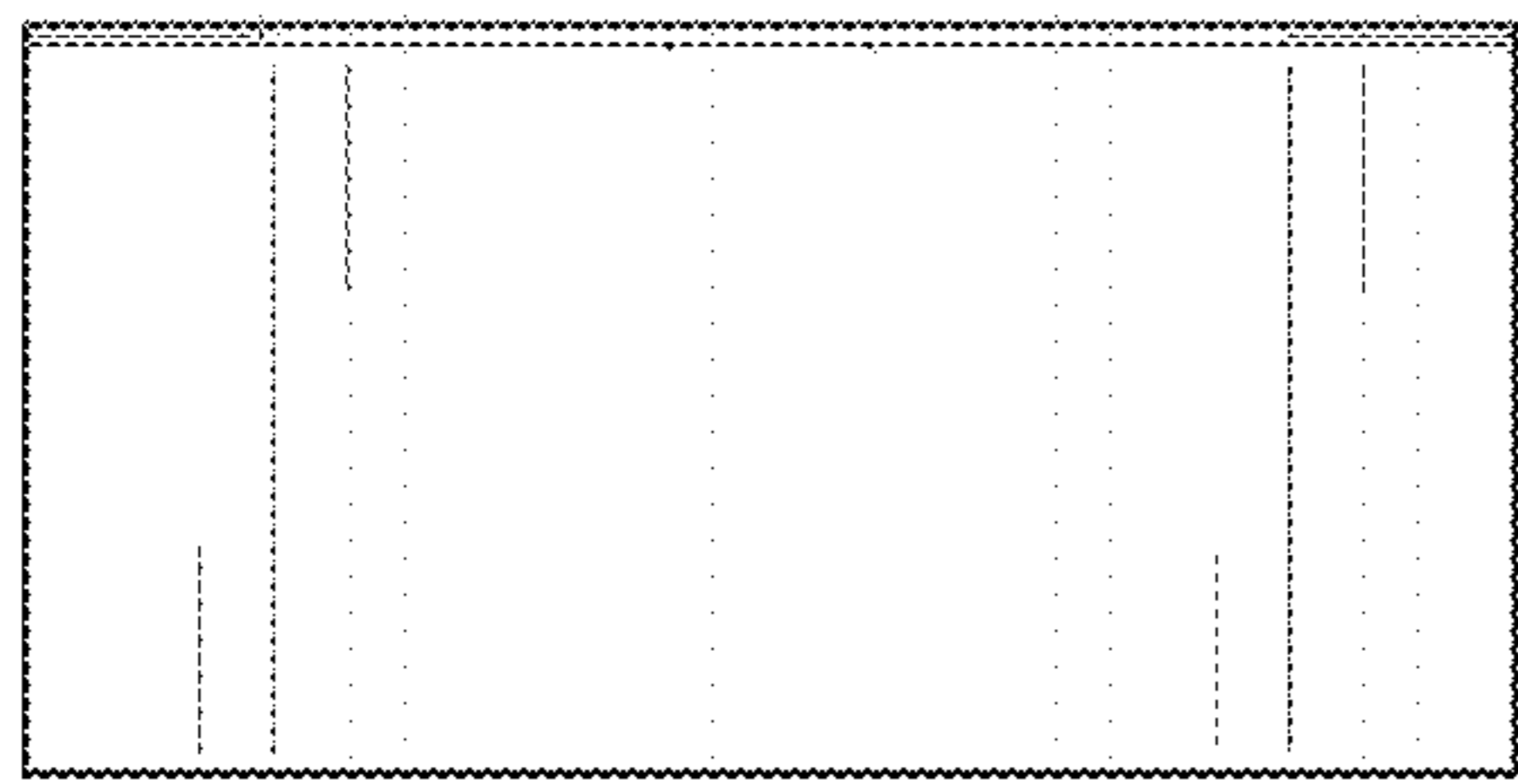

FIG. 6

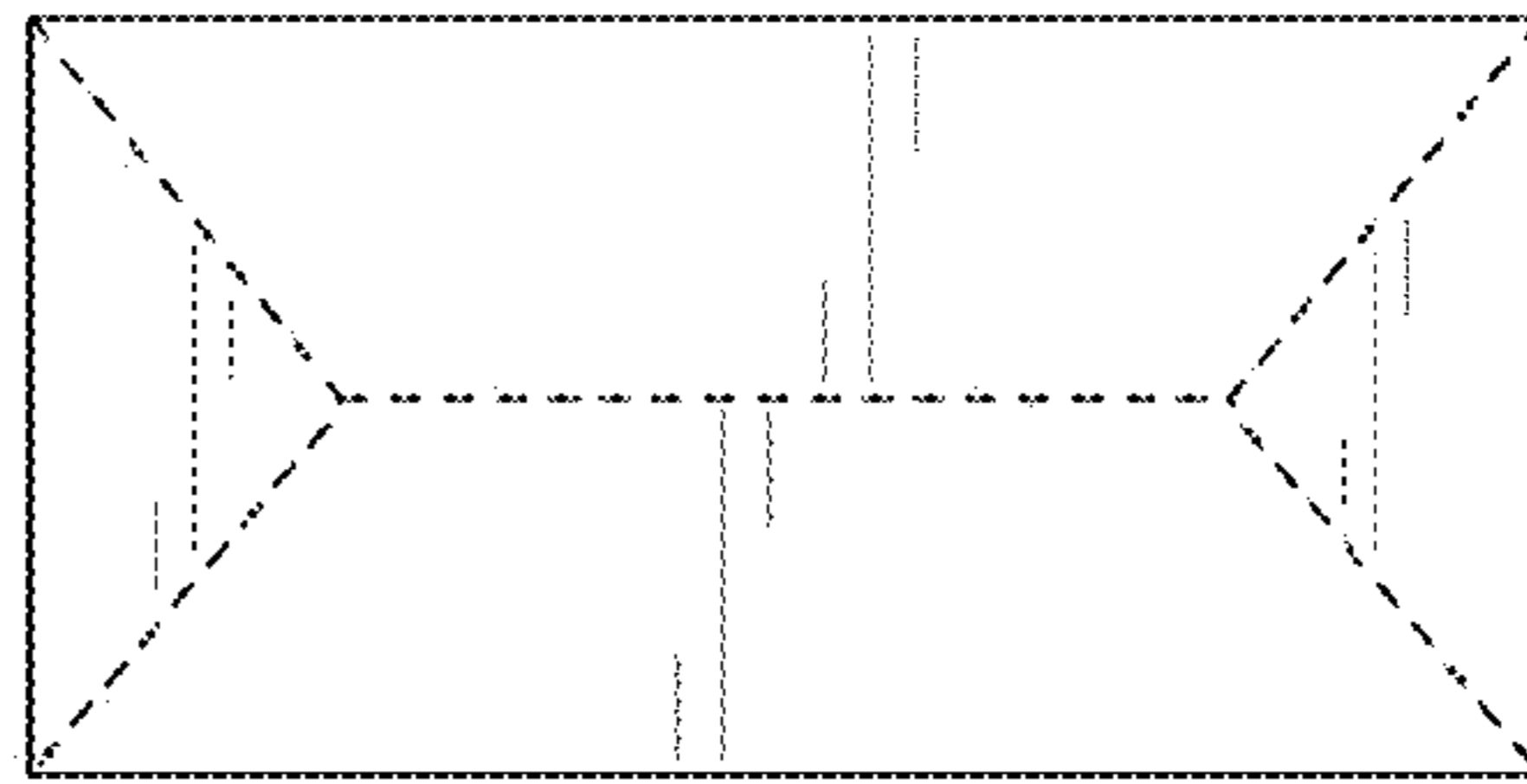

FIG. 7