



US00D706174S

(12) **United States Design Patent**  
**Garand et al.**

(10) **Patent No.:** **US D706,174 S**  
(45) **Date of Patent:** **\*\* Jun. 3, 2014**

(54) **MOTOR VEHICLE, TOY REPLICA AND/OR OTHER REPLICAS**

- (71) Applicant: **Audi AG**, Ingolstadt (DE)
- (72) Inventors: **Dany Garand**, Ingolstadt (DE); **Markus Gleitz**, Ingolstadt (DE)
- (73) Assignee: **Audi AG**, Ingolstadt (DE)
- (\*\*) Term: **14 Years**
- (21) Appl. No.: **29/458,009**
- (22) Filed: **Jun. 14, 2013**

(30) **Foreign Application Priority Data**

Dec. 14, 2012 (EM) ..... 002153320-0001

(51) **LOC (10) Cl.** ..... **12-08**

(52) **U.S. Cl.**  
USPC ..... **D12/92**

(58) **Field of Classification Search**  
USPC ..... D12/86, 90, 91, 92, 98; D21/424, 433,  
D21/434; 296/37.6, 181.1, 181.5, 183.1  
See application file for complete search history.

(56) **References Cited**

**U.S. PATENT DOCUMENTS**

D373,978	S	*	9/1996	Axe et al.	.....	D12/92
D391,522	S	*	3/1998	Hall et al.	.....	D12/92
D395,847	S	*	7/1998	Sacco et al.	.....	D12/92
D406,798	S	*	3/1999	Sacco et al.	.....	D12/92
D615,458	S	*	5/2010	Thompson et al.	.....	D12/92
D629,718	S	*	12/2010	Reichman et al.	.....	D12/92
D641,666	S	*	7/2011	Yi	.....	D12/92
D671,036	S	*	11/2012	Inatomi et al.	.....	D12/92
D679,221	S	*	4/2013	Tomatsu et al.	.....	D12/92
D682,740	S	*	5/2013	Tomatsu et al.	.....	D12/92
D684,095	S	*	6/2013	Beaven	.....	D12/92
D684,900	S	*	6/2013	Doyle et al.	.....	D12/92
2009/0243342	A1	*	10/2009	Christensen et al.	....	296/193.08

**OTHER PUBLICATIONS**

2013 Audi A6. Class Is Now In Session. Electronic Brochure. Jul. 2, 2012 [online], [retrieved on Jan. 12, 2014]. Retrieved from the Internet <URL: [http://www.auto-brochures.com/makes/Audi/A6/Audi\\_US%20A6\\_2013.pdf](http://www.auto-brochures.com/makes/Audi/A6/Audi_US%20A6_2013.pdf)>.\*

2013 Audi A4. Blurring the lines between necessity and desire. Electronic Brochure. Jun. 12, 2012 [online], [retrieved on Jan. 12, 2014]. Retrieved from the Internet <URL: [http://www.auto-brochures.com/makes/Audi/A4/Audi\\_US%20A4\\_2013.pdf](http://www.auto-brochures.com/makes/Audi/A4/Audi_US%20A4_2013.pdf)>.\*

2013 Audi A8. There's a new class of flagship. Electronic Brochure. Jul. 5, 2012 [online], [retrieved on Jan. 12, 2014]. Retrieved from the Internet <URL: [http://www.auto-brochures.com/makes/Audi/A8/Audi\\_US%20A8\\_2013.pdf](http://www.auto-brochures.com/makes/Audi/A8/Audi_US%20A8_2013.pdf)>.\*

\* cited by examiner

*Primary Examiner* — Philip S Hyder  
*Assistant Examiner* — Darlington Ly

(74) *Attorney, Agent, or Firm* — Abelman, Frayne & Schwab

(57) **CLAIM**

The ornamental design for motor vehicle, toy replica and/or other replicas, as shown and described.

**DESCRIPTION**

FIG. 1 is a front and left-side perspective view of the motor vehicle, toy replica and/or other replicas, showing our new design;

FIG. 2 is a rear and left-side perspective view of the motor vehicle, toy replica and/or other replicas, of FIG. 1;

FIG. 3 is a right side elevational view thereof;

FIG. 4 is a left side elevational view thereof;

FIG. 5 is a top plan view thereof;

FIG. 6 is a rear elevational view thereof; and,

FIG. 7 is a front elevational view thereof.

The broken lines represent portions of the motor vehicle, toy replica and/or other replicas, and environmental matter that form no part of the claimed design.

**1 Claim, 5 Drawing Sheets**

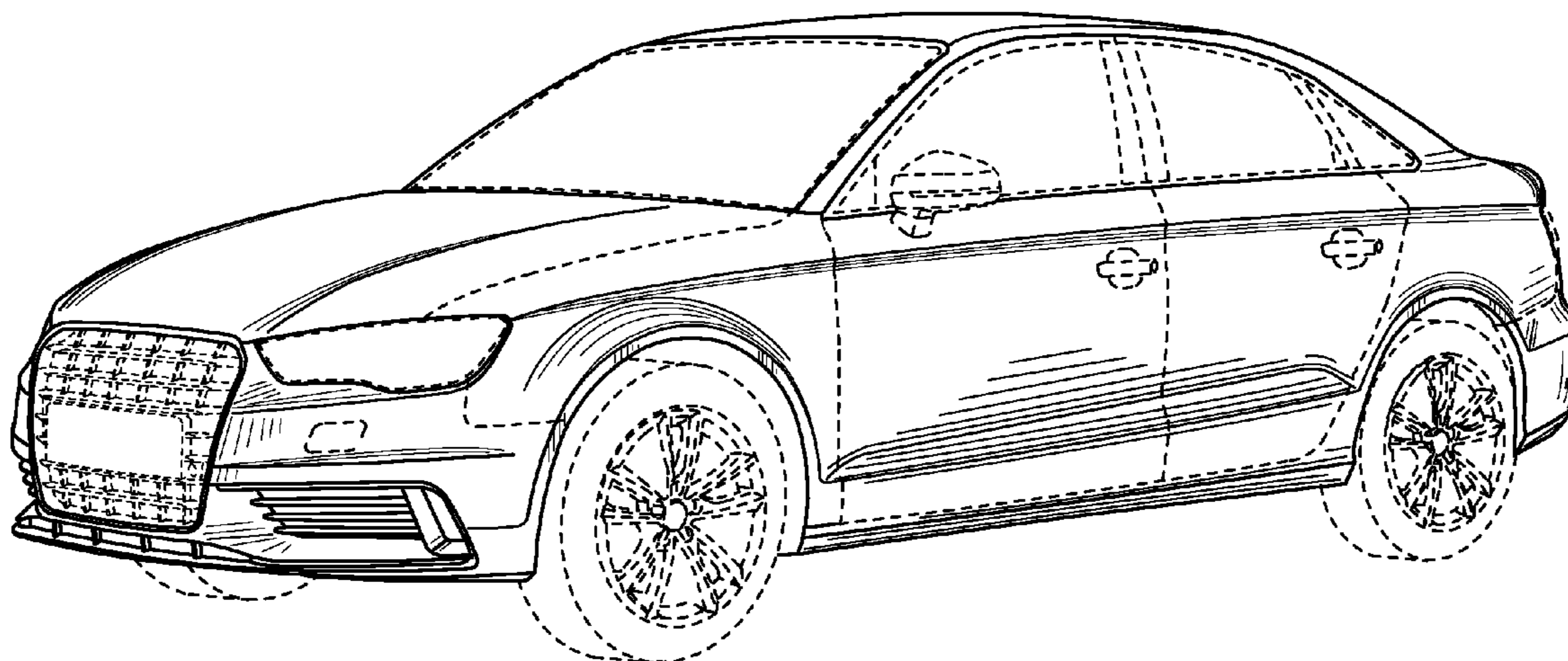

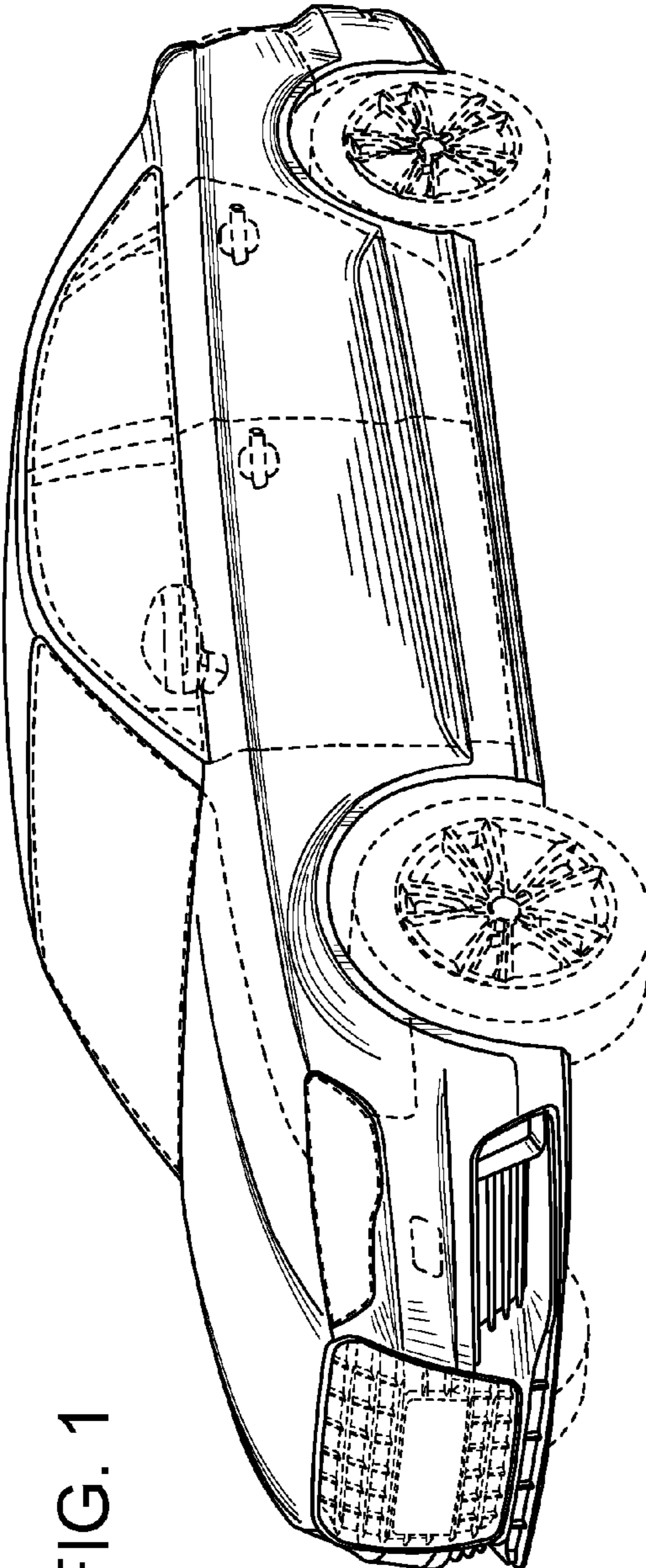

FIG. 1

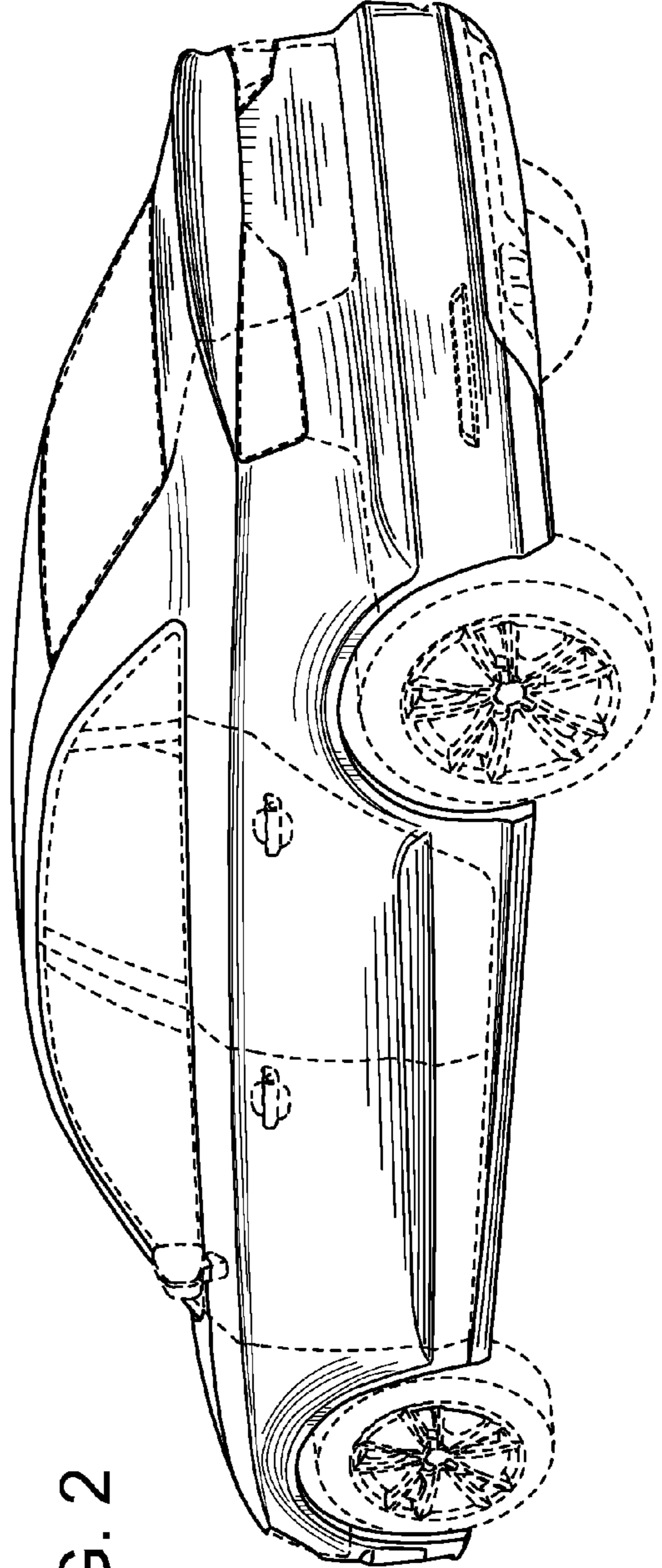

FIG. 2

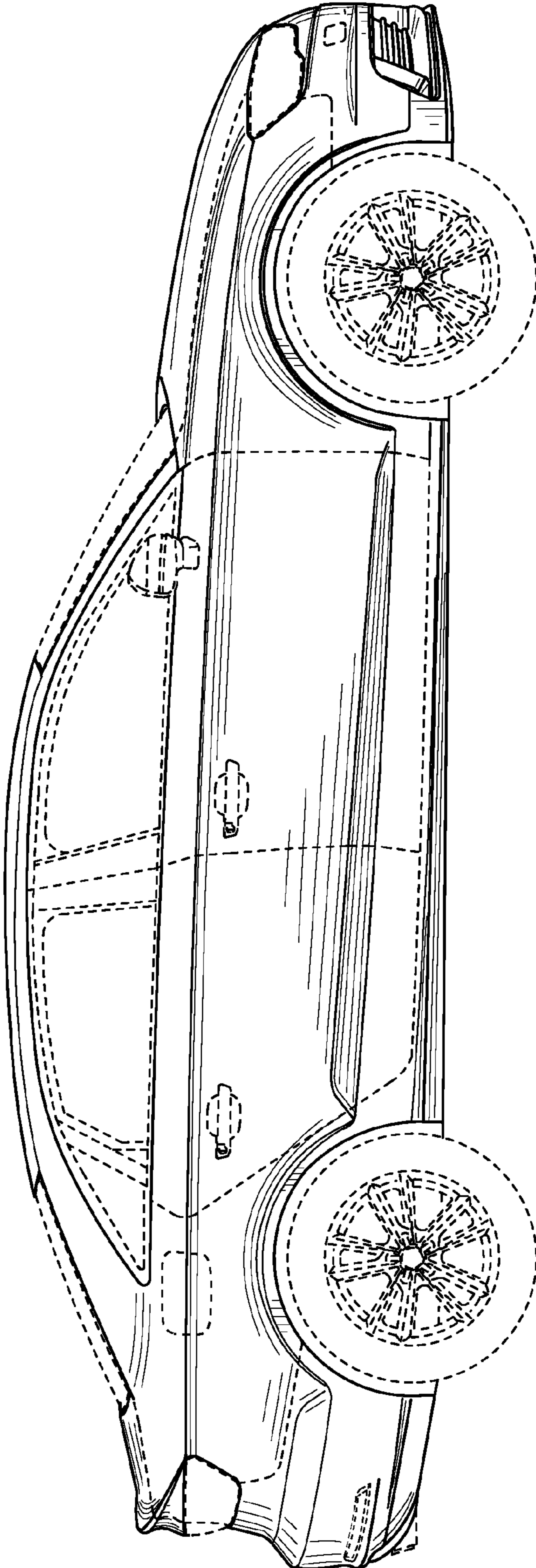
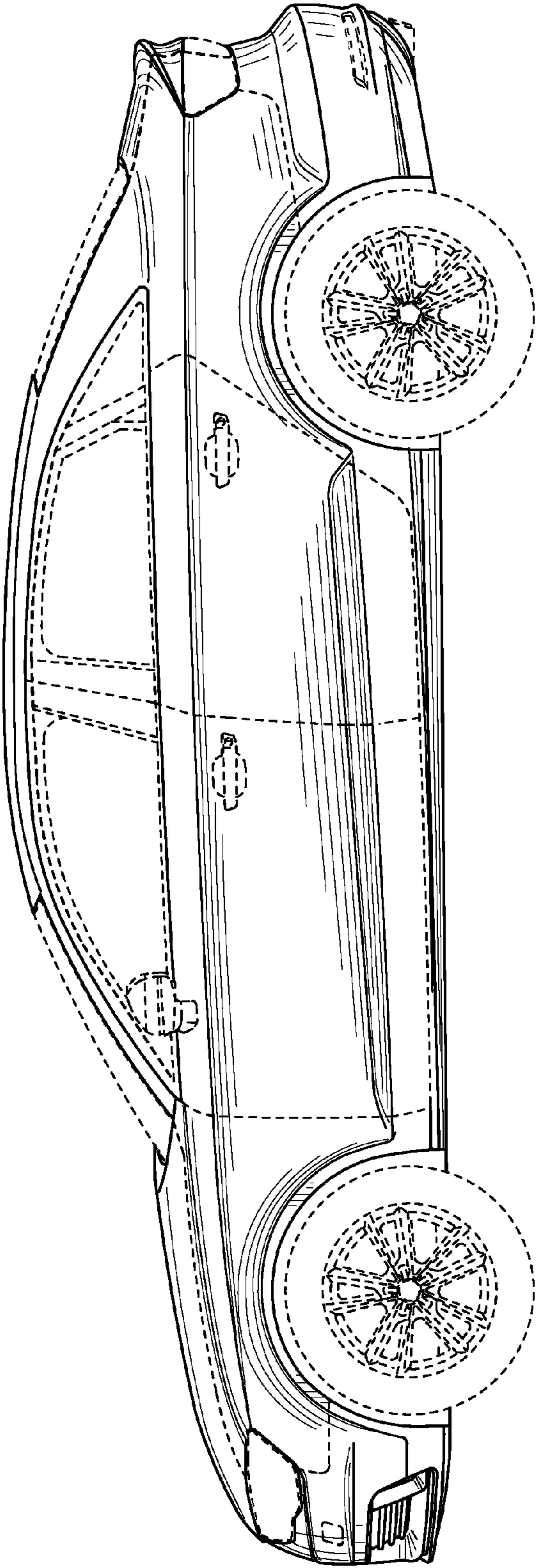

FIG. 3

FIG. 4



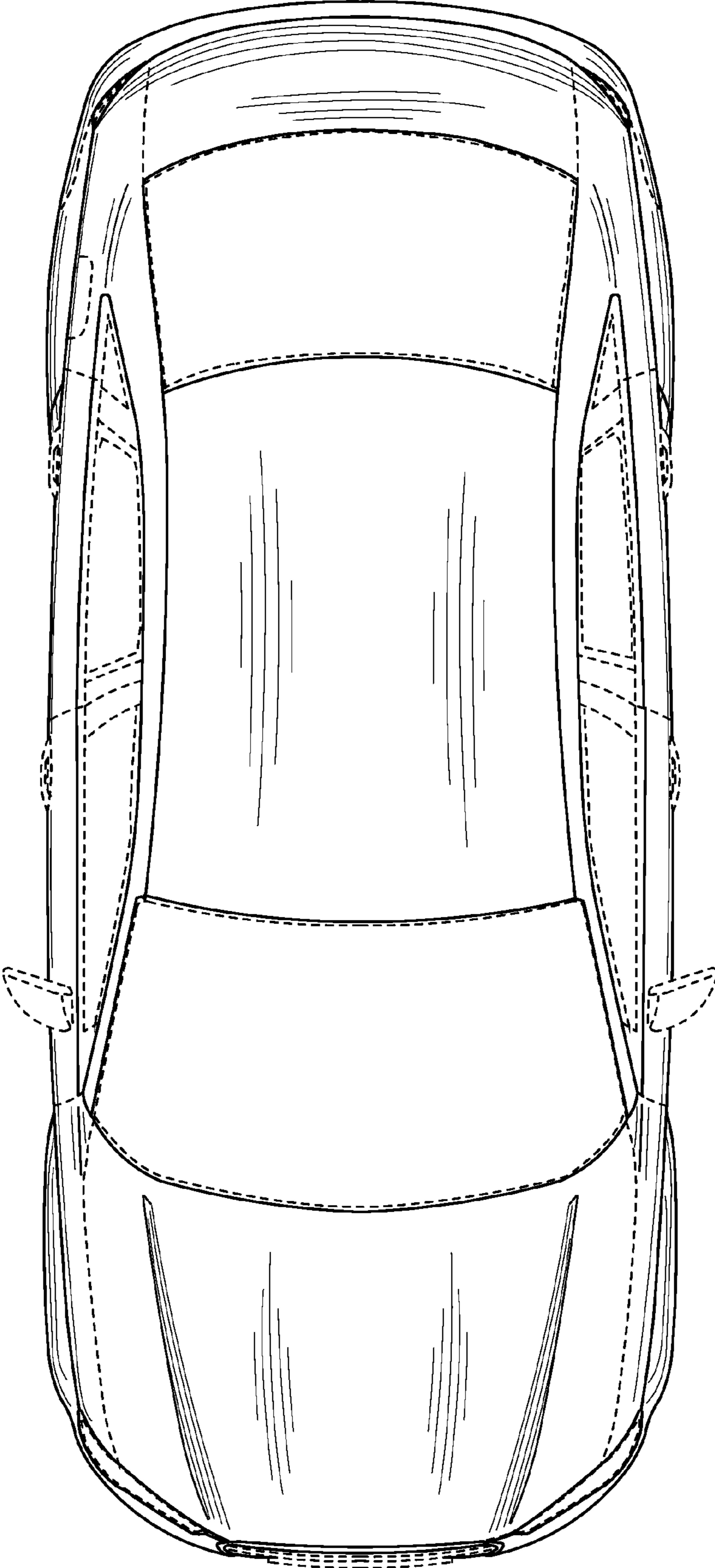

FIG. 5

FIG. 6

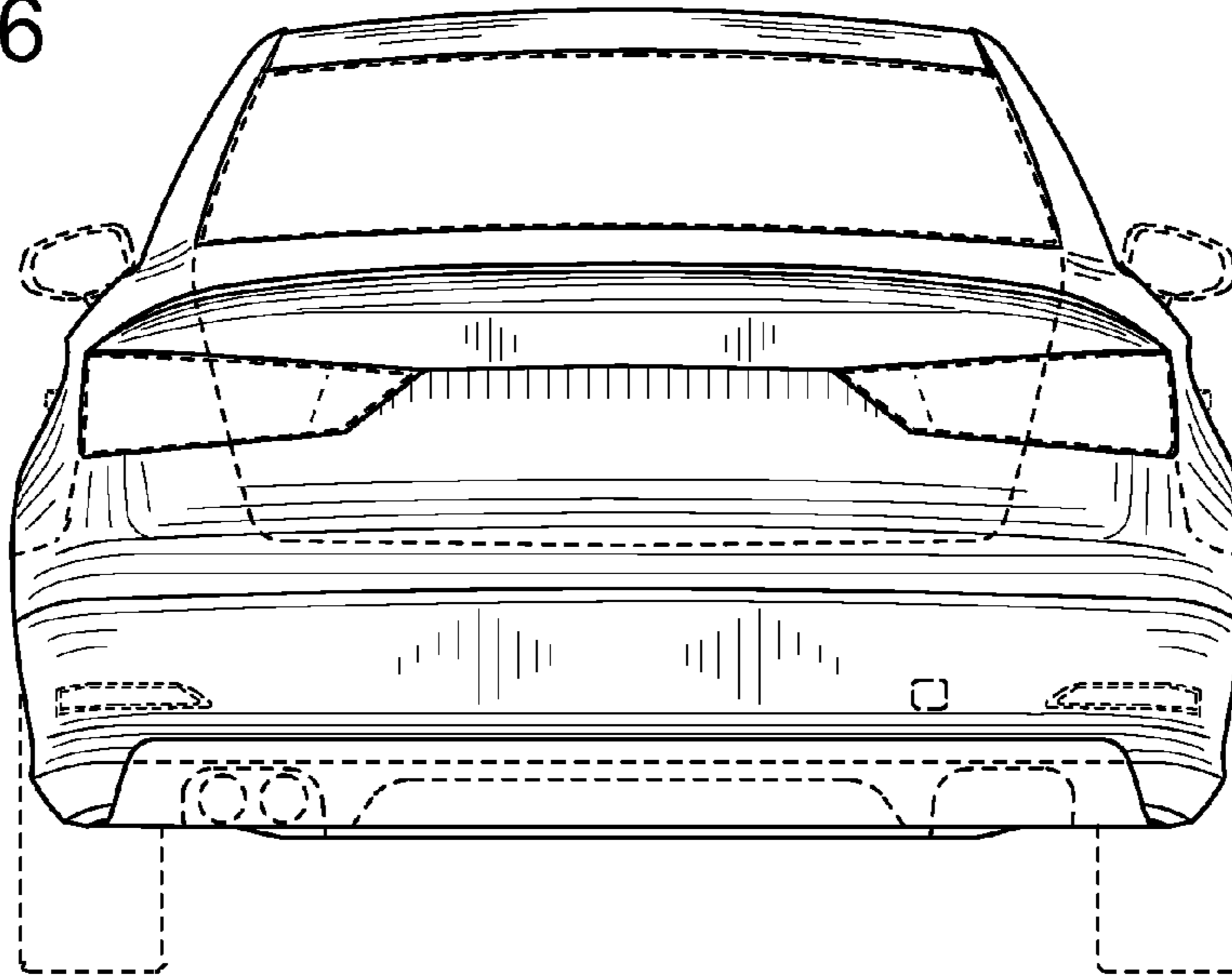

FIG. 7

