



US00D706096S

(12) **United States Design Patent**  
**Stokes et al.**

(10) **Patent No.:** **US D706,096 S**  
(45) **Date of Patent:** **\*\* Jun. 3, 2014**

- (54) **PRUNER**
- (71) Applicant: **Fiskars Brands, Inc.**, Madison, WI (US)
- (72) Inventors: **Steven Stokes**, Mazomanie, WI (US);  
**Colin Roberts**, Stevens Point, WI (US)
- (73) Assignee: **Fiskars Brands, Inc.**, Madison, WI (US)
- (\*\*) Term: **14 Years**
- (21) Appl. No.: **29/436,682**
- (22) Filed: **Nov. 8, 2012**
- (51) **LOC (10) Cl.** ..... **08-01**
- (52) **U.S. Cl.**  
USPC ..... **D8/5**
- (58) **Field of Classification Search**  
USPC ..... D8/4, 5; 30/251–252, 261–262, 266  
See application file for complete search history.

- D649,420 S \* 11/2011 Cunningham et al. .... D8/57
- D651,053 S 12/2011 Roberts et al.
- D651,487 S 1/2012 Roberts et al.
- D655,990 S 3/2012 Block et al.

**OTHER PUBLICATIONS**

- U.S. Appl. No. 29/426,223, filed Jul. 2, 2012, Sade et al.
- U.S. Appl. No. 29/426,233, filed Jul. 2, 2012, Sade et al.

\* cited by examiner

*Primary Examiner* — Sheryl Lane

(74) *Attorney, Agent, or Firm* — Foley & Lardner LLP

(57) **CLAIM**

We claim the ornamental design for a pruner, as shown and described.

**DESCRIPTION**

FIG. 1 is a top front perspective view of an embodiment of the claimed design;

FIG. 2 is a bottom front perspective view of the claimed design of FIG. 1;

FIG. 3 is a front elevation view of the claimed design of FIG. 1;

FIG. 4 is a rear elevation view of the claimed design of FIG. 1;

FIG. 5 is a top view of the claimed design of FIG. 1;

FIG. 6 is a bottom view of the claimed design of FIG. 1;

FIG. 7 is a right side elevation view of the claimed design of FIG. 1; and,

FIG. 8 is a left side elevation view of the claimed design of FIG. 1.

The broken lines represent portions of the pruner and form no part of the claimed design.

**1 Claim, 6 Drawing Sheets**

(56) **References Cited**

U.S. PATENT DOCUMENTS

- D301,537 S 6/1989 Pittaway
- D301,538 S 6/1989 Pittaway
- D305,090 S 12/1989 Collins et al.
- 5,426,857 A 6/1995 Linden
- 5,697,159 A 12/1997 Linden
- D463,227 S \* 9/2002 Choi ..... D8/5
- 6,513,248 B2 2/2003 Linden et al.
- D472,433 S \* 4/2003 Richwine et al. .... D8/5
- 6,829,828 B1 12/2004 Cech et al.
- D501,379 S 2/2005 Lipscomb et al.
- D503,595 S 4/2005 Lipscomb et al.
- D557,086 S 12/2007 Lipscomb et al.
- D576,468 S 9/2008 Lipscomb et al.
- D595,548 S 7/2009 Lipscomb et al.
- D628,031 S 11/2010 Stokes et al.
- D628,032 S 11/2010 Stokes et al.
- D630,067 S 1/2011 Block et al.

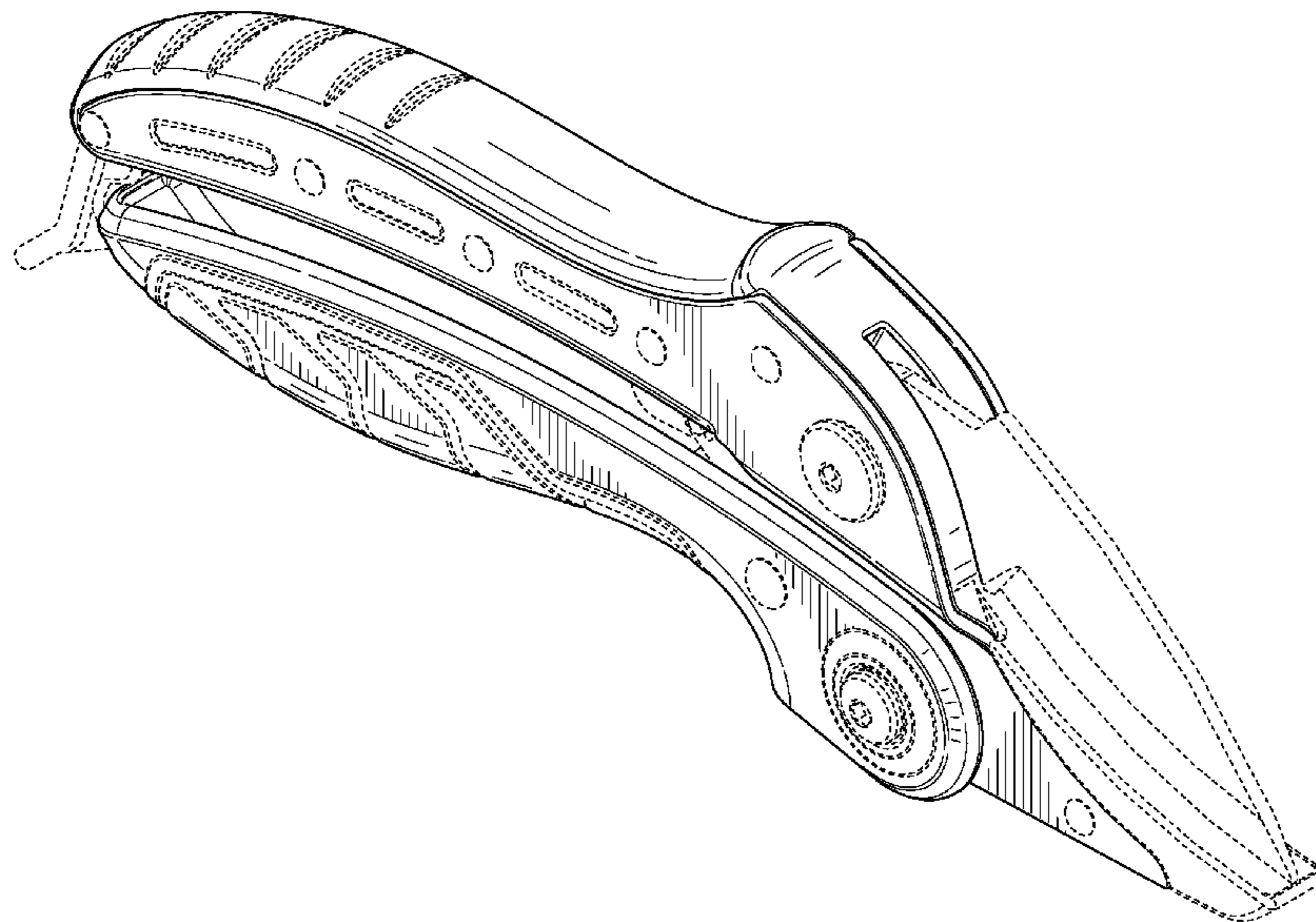

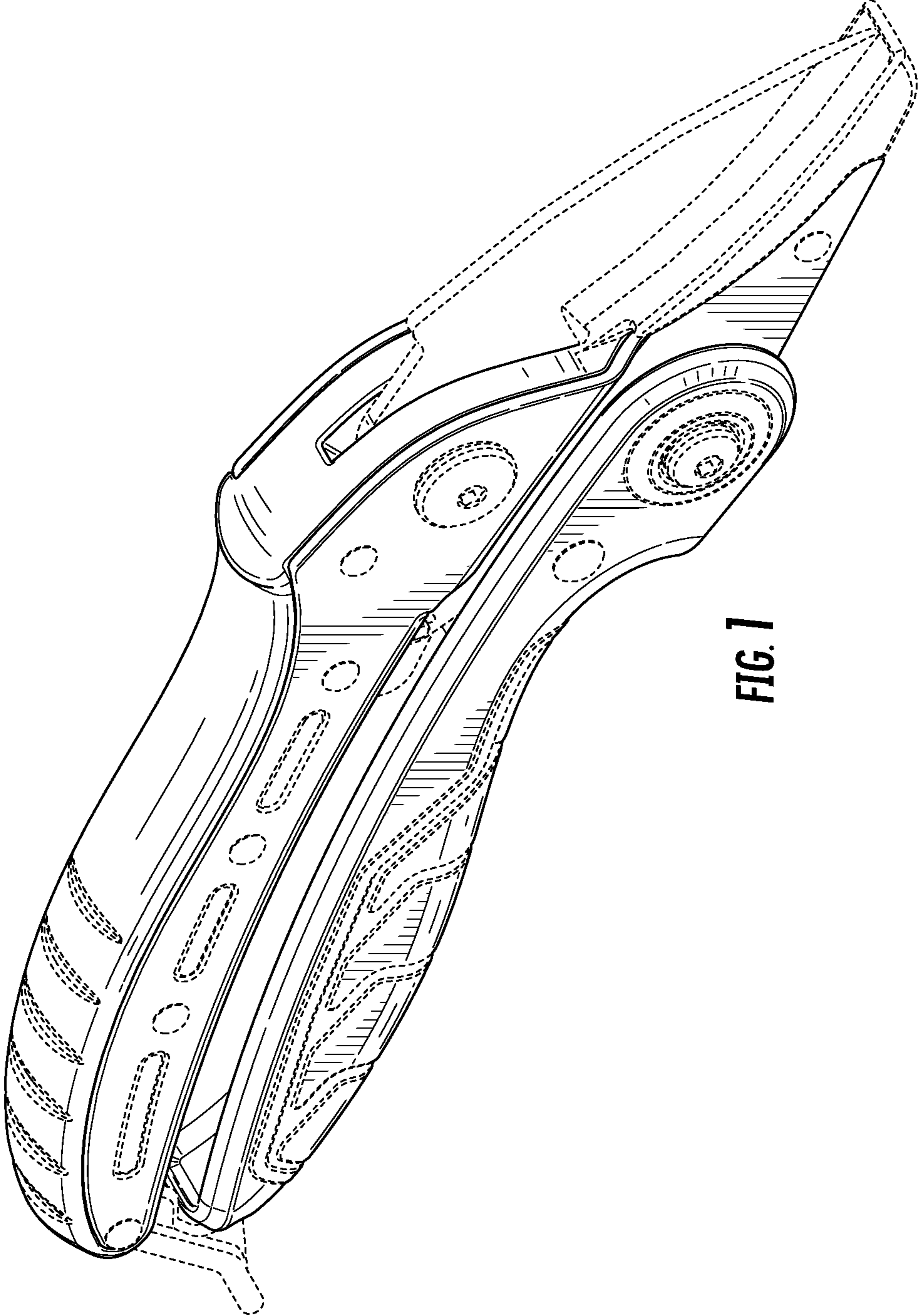

FIG. 1

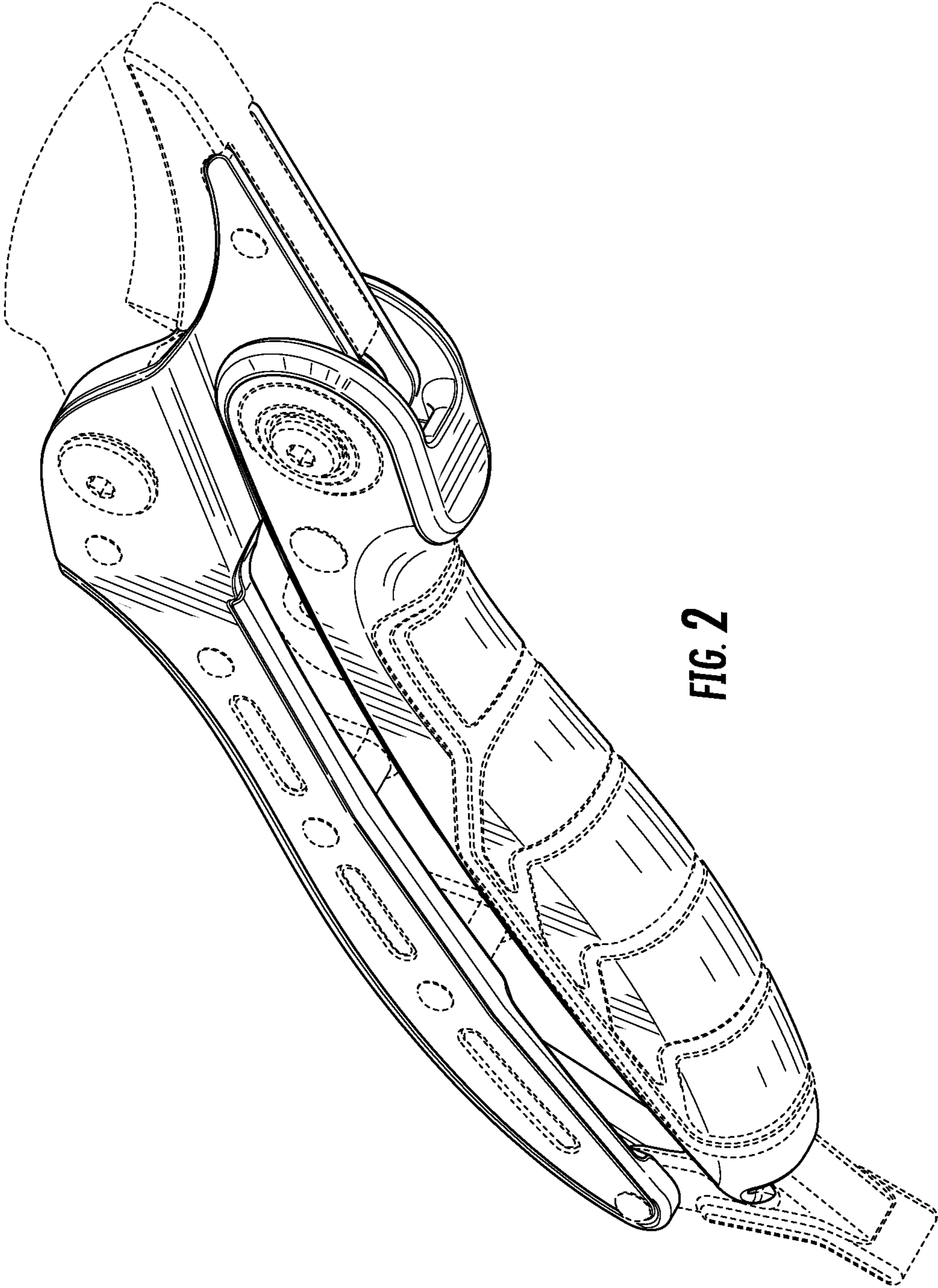

FIG. 2

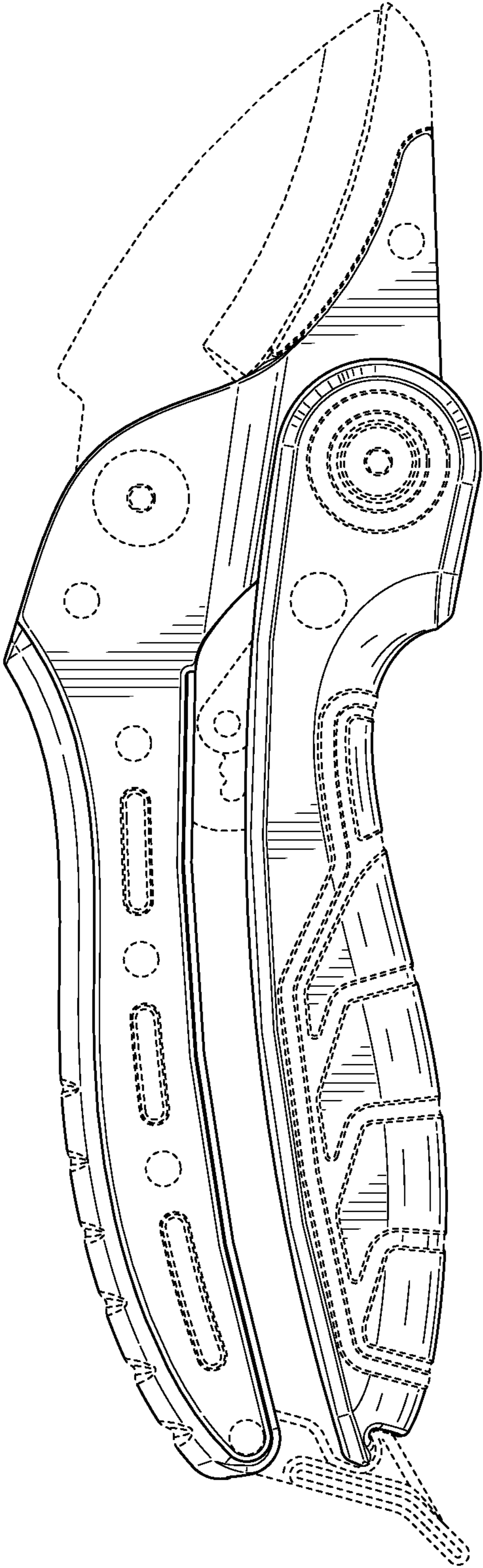

FIG. 3

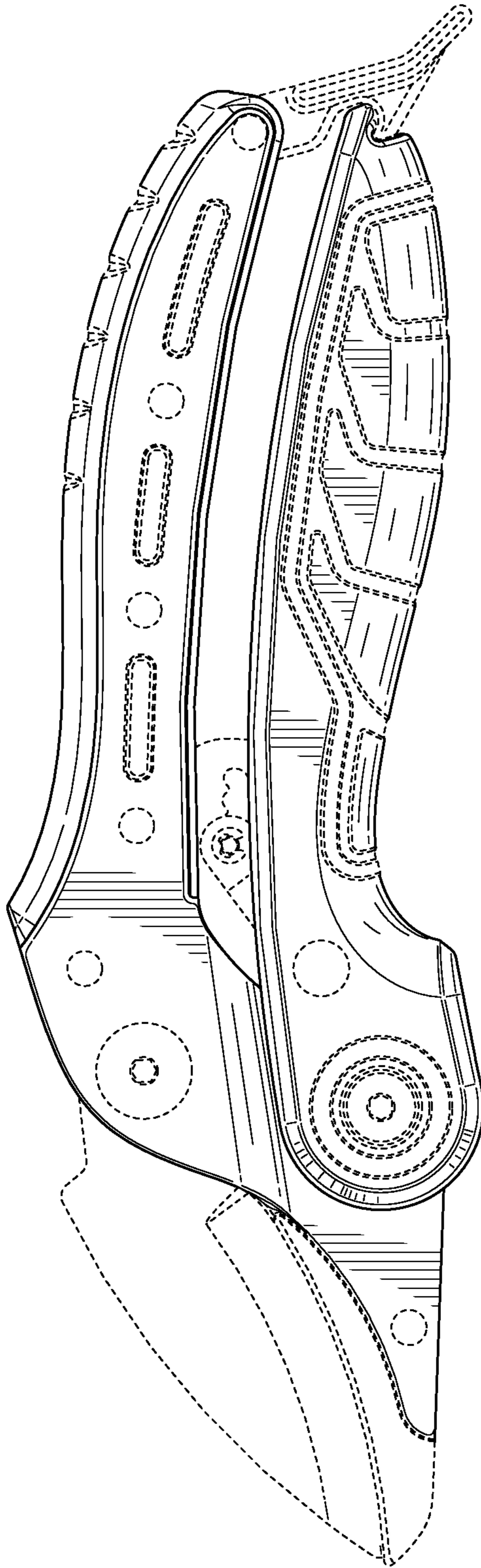

FIG. 4

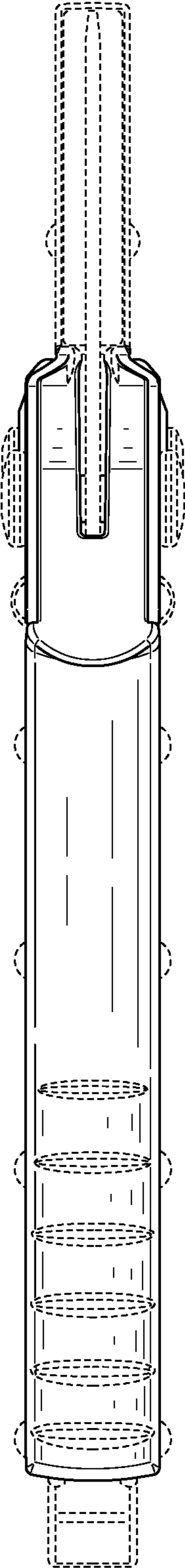

FIG. 5

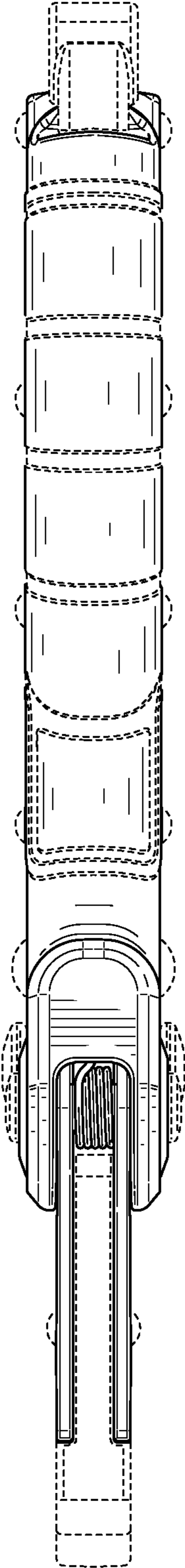

FIG. 6

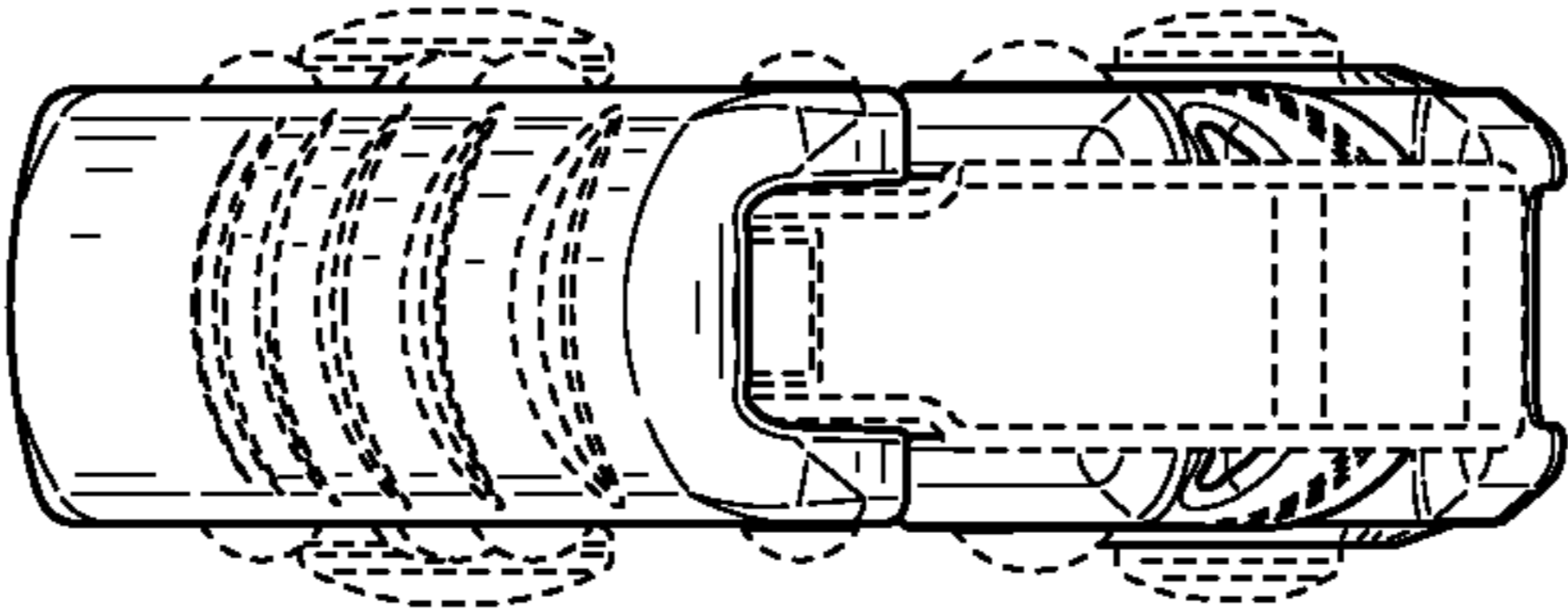

FIG. 8

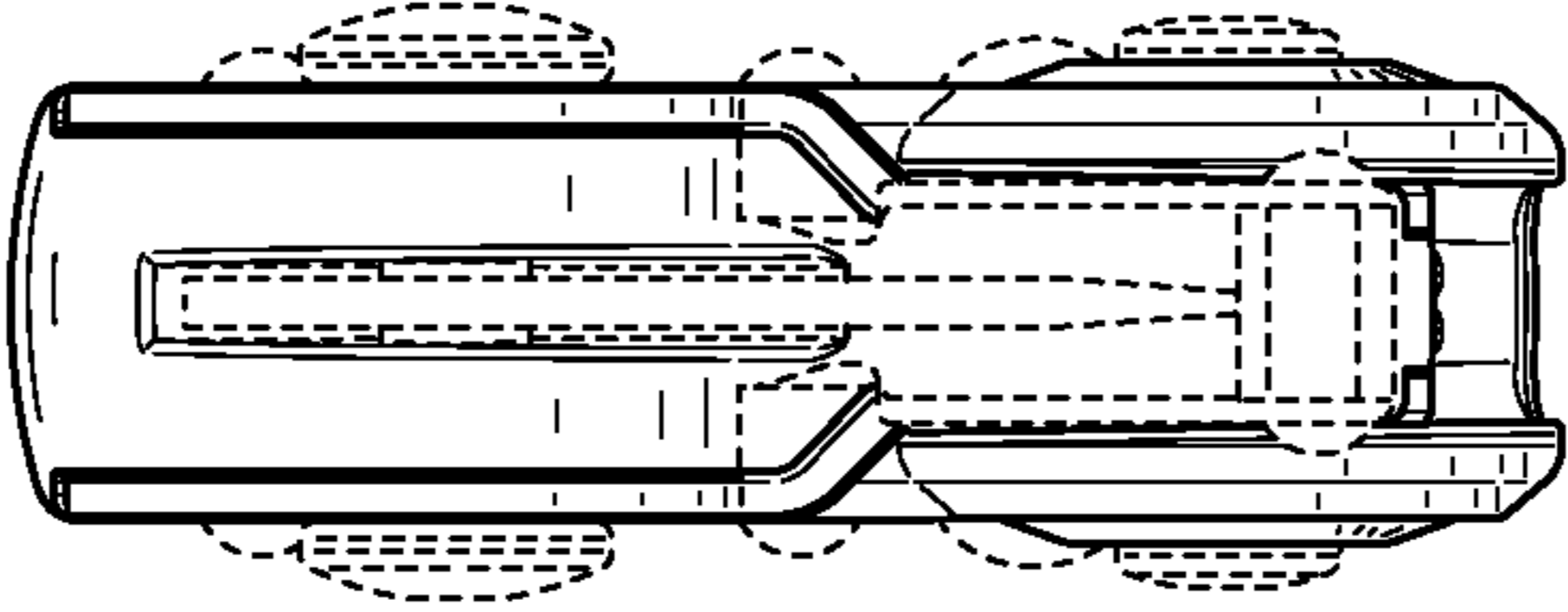

FIG. 7