



US00D706070S

(12) **United States Design Patent**  
**Matthews, II**

(10) **Patent No.:** **US D706,070 S**  
(45) **Date of Patent:** **\*\* Jun. 3, 2014**

(54) **HAMMOCK**

(71) Applicant: **Matthews Pride, LLC**, Columbia, MD  
(US)

(72) Inventor: **Curtis R. Matthews, II**, Columbia, MD  
(US)

(73) Assignee: **Matthews Pride, LLC**, Columbia, MD  
(US)

(\*\*) Term: **14 Years**

(21) Appl. No.: **29/446,230**

(22) Filed: **Feb. 21, 2013**

(51) **LOC (10) Cl.** ..... **06-06**

(52) **U.S. Cl.**  
USPC ..... **D6/718.1; D61/387**

(58) **Field of Classification Search**  
USPC ..... **D6/383, 386, 387, 718.1, 608, 595;**  
**5/120-123, 127, 128, 417**  
See application file for complete search history.

(56) **References Cited**

**U.S. PATENT DOCUMENTS**

695,374 A \* 3/1902 Chadbourne ..... 5/122  
913,750 A \* 3/1909 Meyer ..... 5/123  
D244,068 S \* 4/1977 Styron, Jr. .... D6/347

6,314,594 B1 \* 11/2001 Meoli et al. .... 5/120  
6,467,109 B1 \* 10/2002 Wu ..... 5/120  
6,829,792 B2 \* 12/2004 Braly ..... 5/121

\* cited by examiner

*Primary Examiner* — Janice Seeger

(74) *Attorney, Agent, or Firm* — HolzerIPLaw, PC

(57) **CLAIM**

The ornamental design for a hammock, as shown and described.

**DESCRIPTION**

FIG. 1 is a perspective view of an embodiment of a hammock; FIG. 2 is a front side view of the embodiment of the hammock shown in FIG. 1; FIG. 3 is a back view of the embodiment of the hammock shown in FIG. 1; FIG. 4 is a right side view of the embodiment of the hammock shown in FIG. 1; FIG. 5 is a left side view of the embodiment of the hammock shown in FIG. 1; FIG. 6 is a top view of the embodiment of the hammock shown in FIG. 1; FIG. 7 is a bottom view of the embodiment of the hammock shown in FIG. 1; and, FIG. 8 is an enlarged view of a section of the embodiment of the hammock shown in FIG. 1.

**1 Claim, 6 Drawing Sheets**

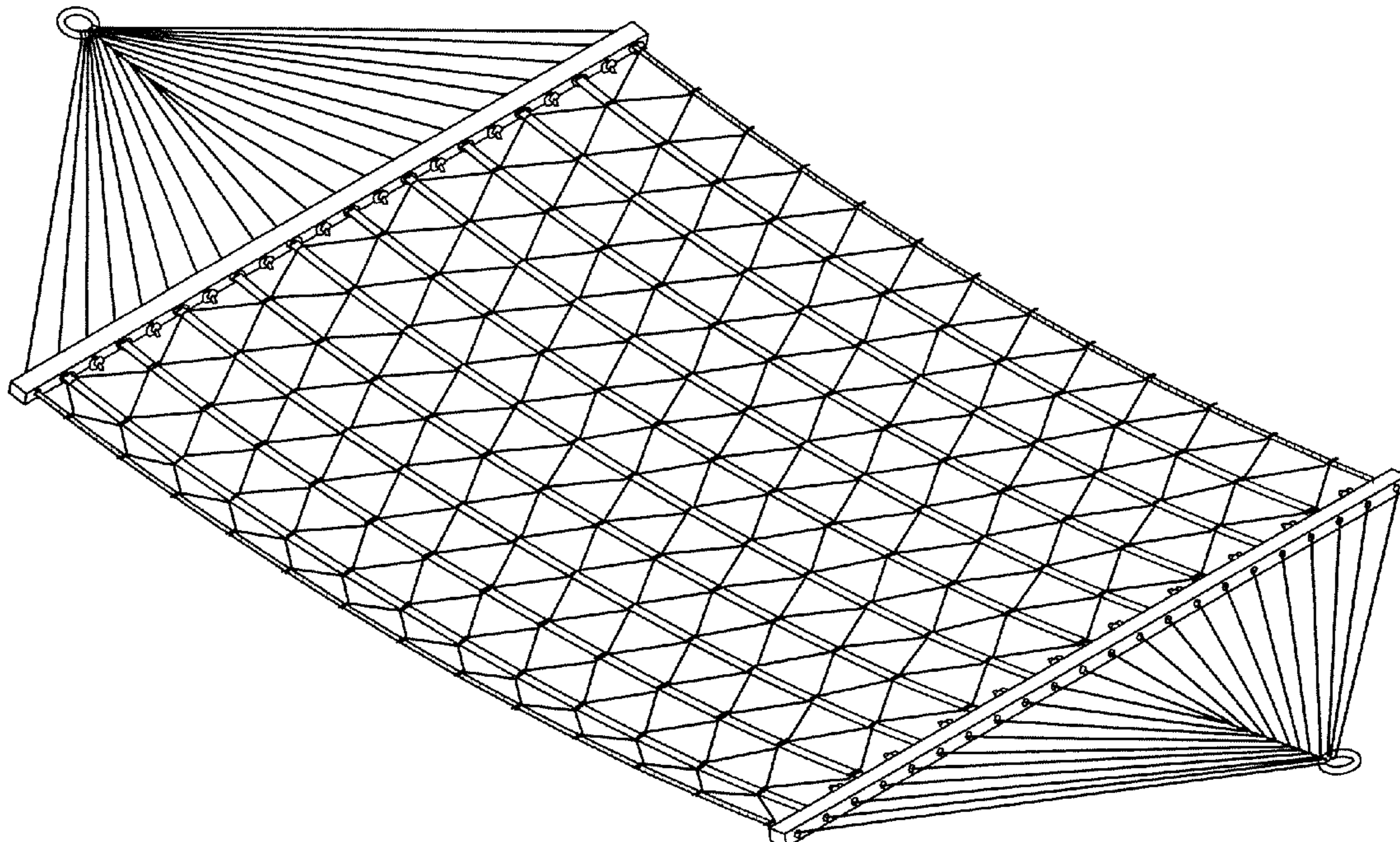

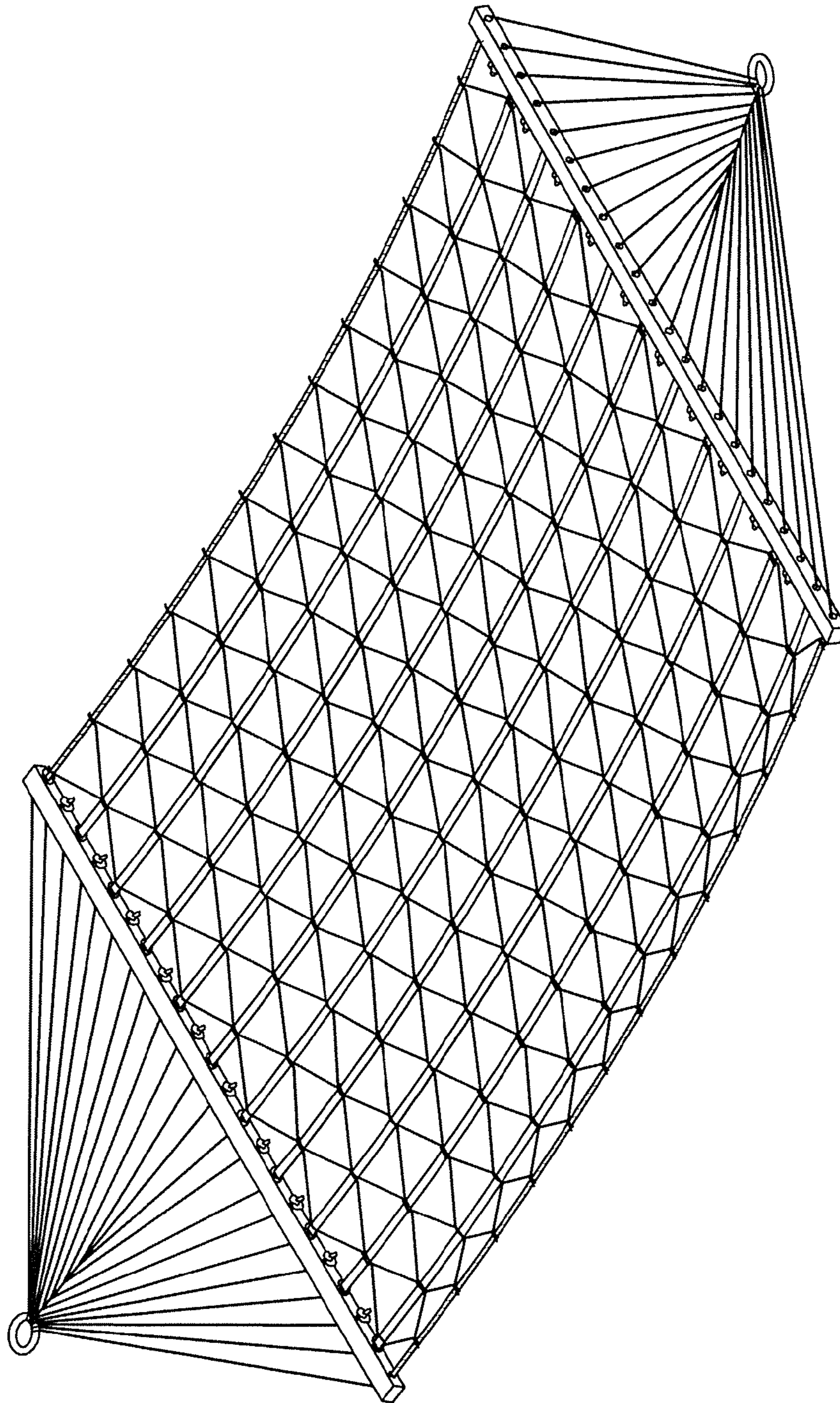

FIG.1

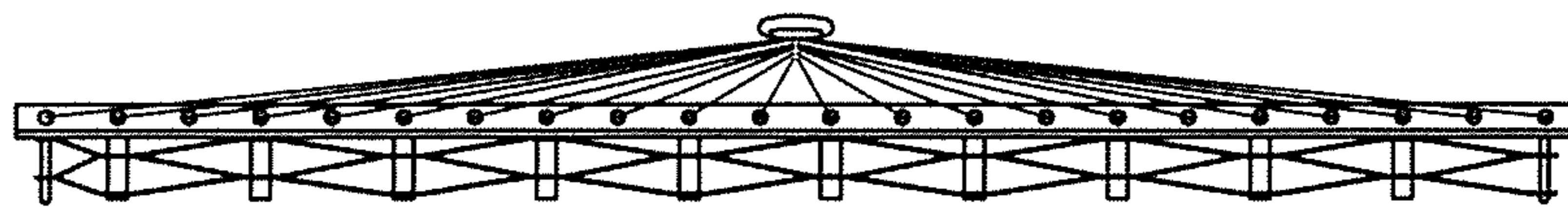

FIG. 2

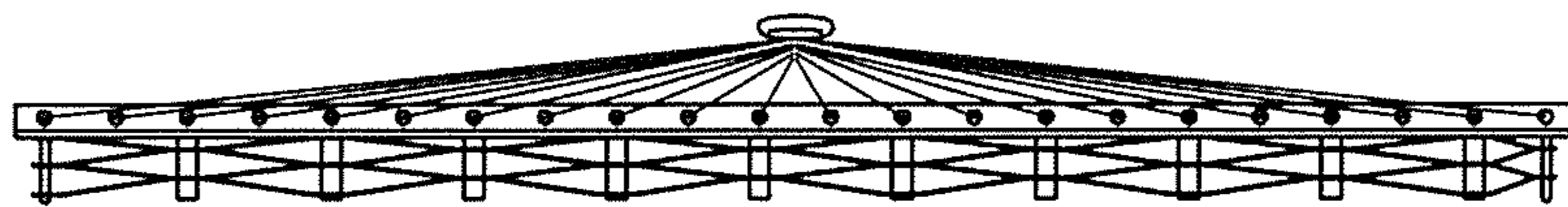

FIG. 3

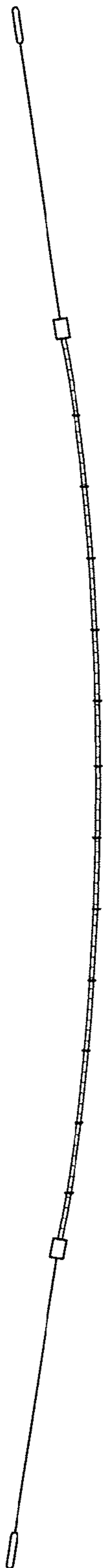

FIG. 4



FIG. 5

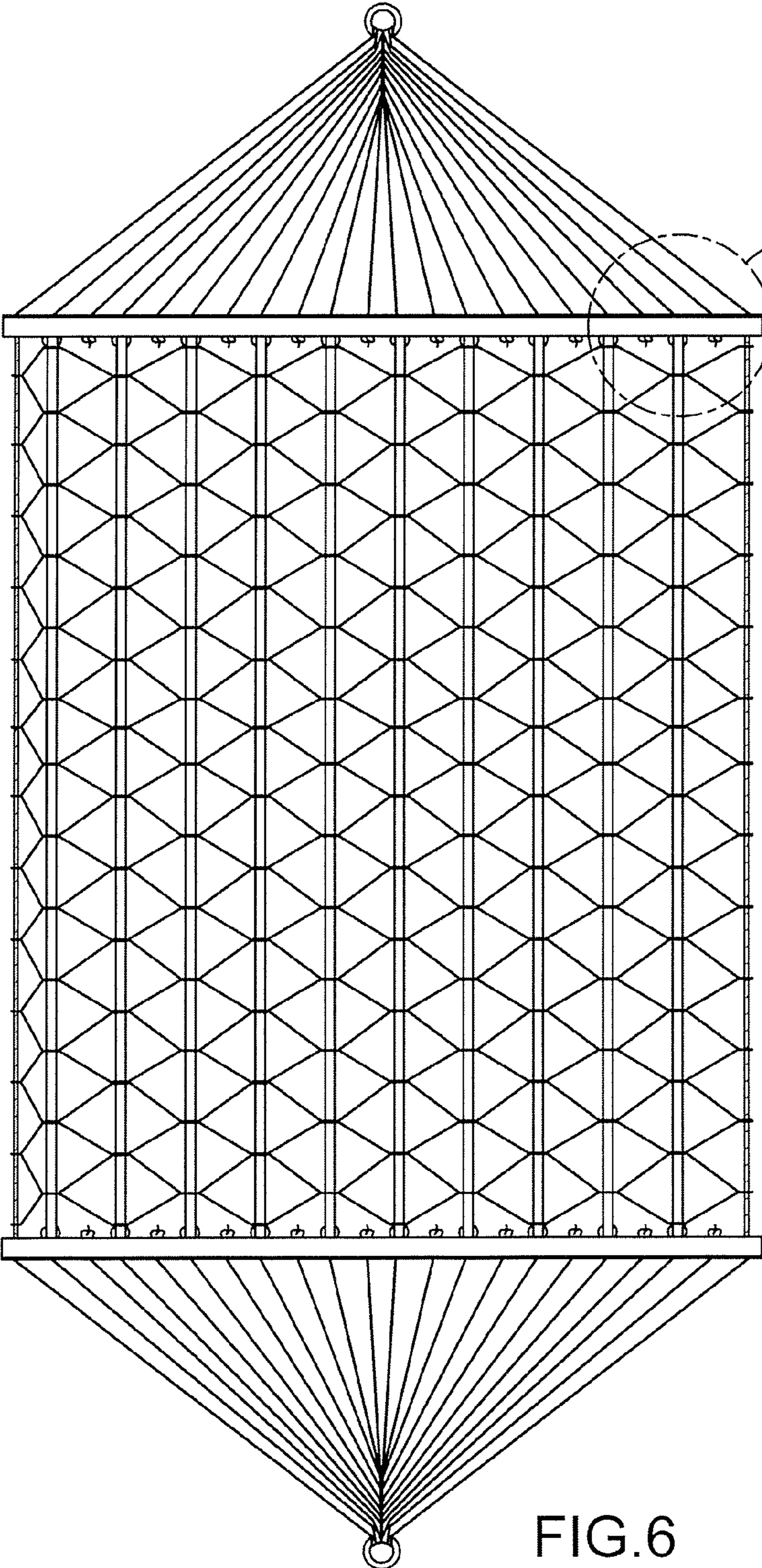

FIG.8

FIG.6

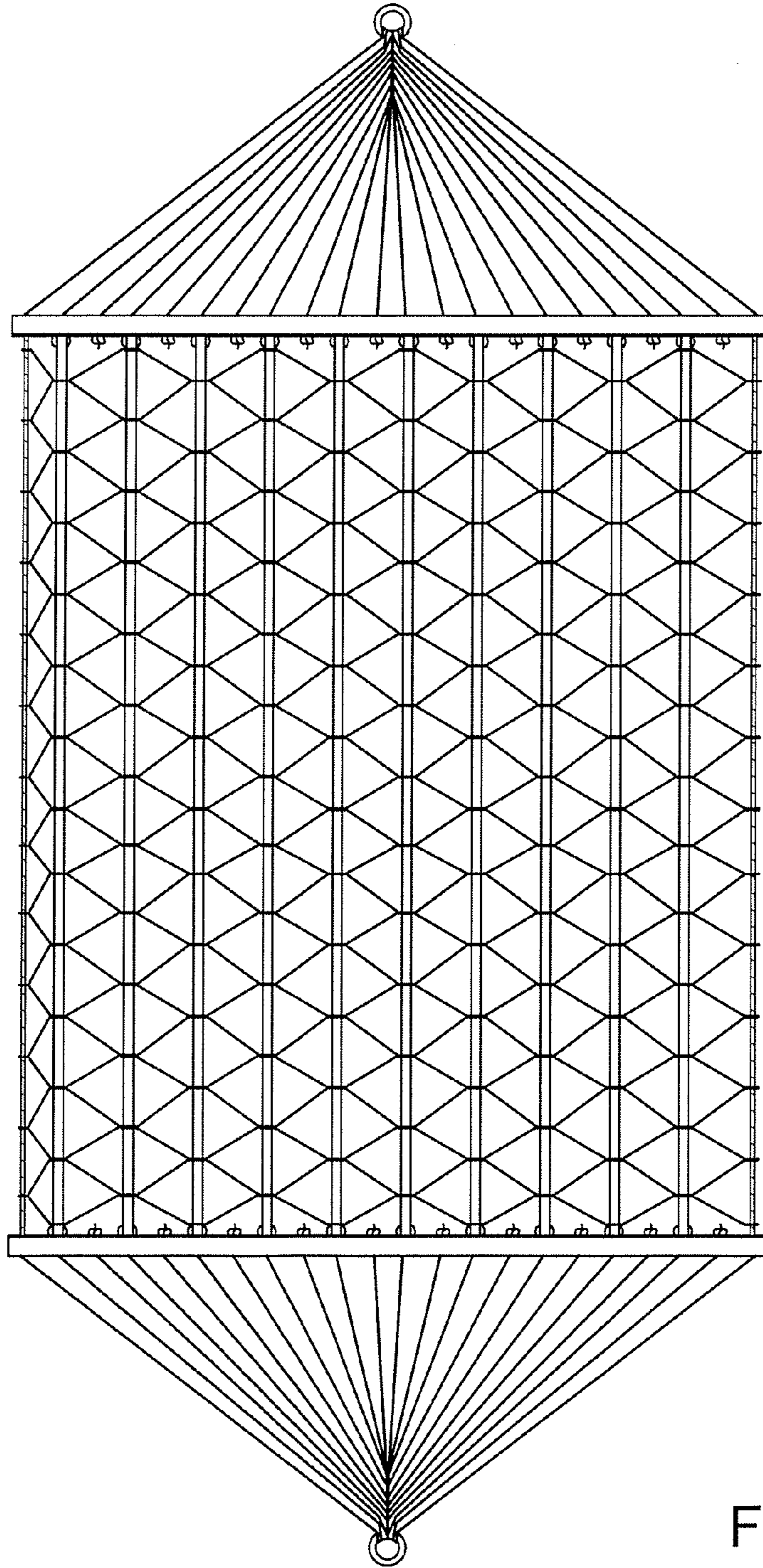

FIG. 7

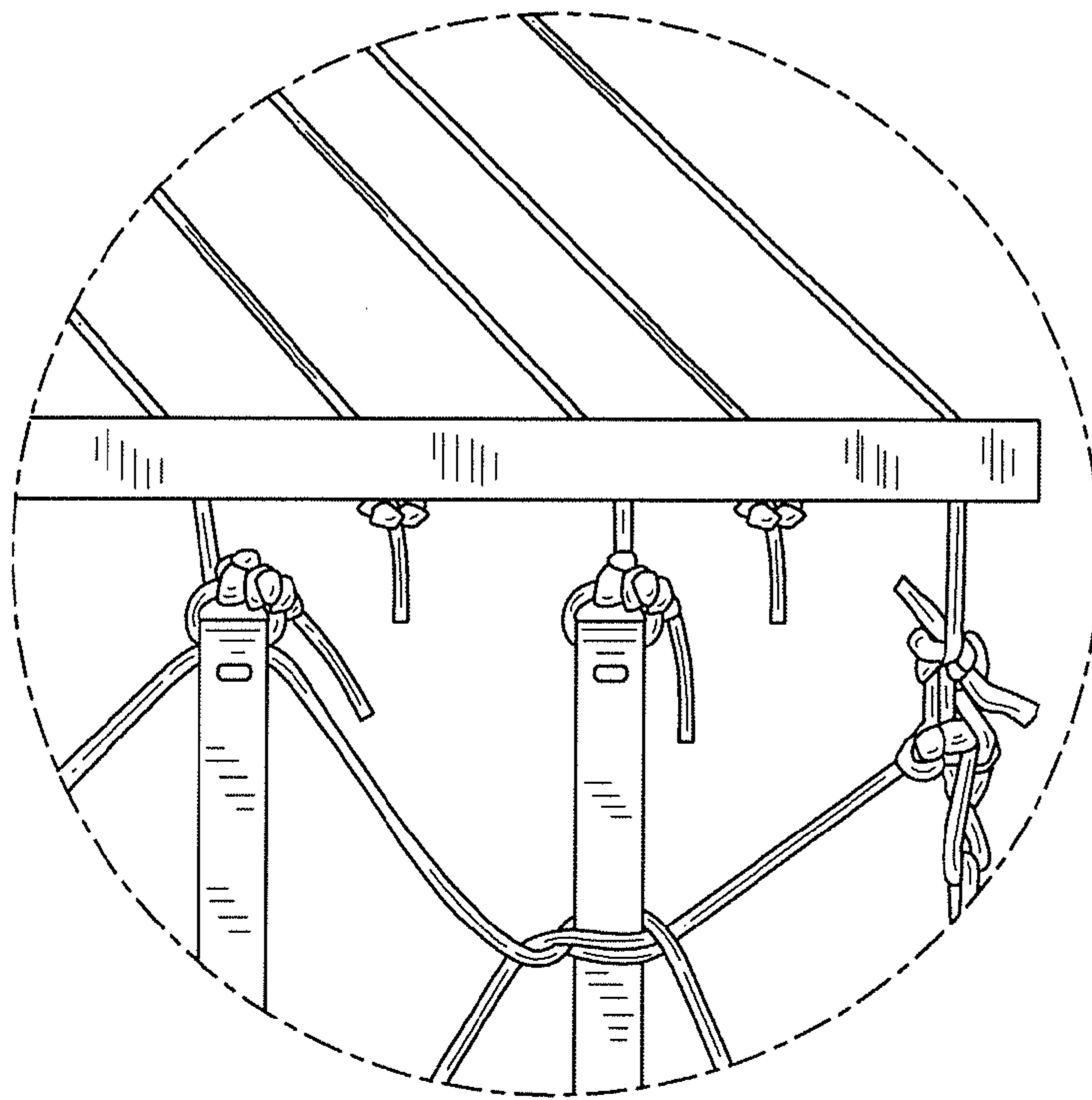

FIG.8