

US00D705935S

(12) **United States Design Patent**
Matuschek et al.

(10) **Patent No.:** **US D705,935 S**

(45) **Date of Patent:** **** May 27, 2014**

(54) **X-RAY SCANNER**

(71) Applicant: **Smiths Heimann GmbH**, Wiesbaden (DE)

(72) Inventors: **Walter Matuschek**, Aalen (DE); **Christian Siegel**, Aalen (DE); **Lisa Kiefert**, Heidenheim (DE); **Graham Kevy**, Aalen (DE)

(73) Assignee: **Smiths Heimann GmbH**, Wiesbaden (DE)

(**) Term: **14 Years**

(21) Appl. No.: **29/450,699**

(22) Filed: **Mar. 21, 2013**

(51) **LOC (10) Cl.** **24-01**

(52) **U.S. Cl.**
USPC **D24/158**

(58) **Field of Classification Search**
USPC D24/158-161, 185, 186; 378/4, 15, 17, 378/20, 21, 23-27, 62, 68, 146, 195-198, 378/57; 382/110

See application file for complete search history.

(56) **References Cited**

U.S. PATENT DOCUMENTS

D283,729 S * 5/1986 Ramsey D24/158
D300,849 S * 4/1989 Steinhilber et al. D24/159

D323,711 S * 2/1992 Takekoshi et al. D24/159
D386,261 S * 11/1997 Lee et al. D24/159
5,982,843 A * 11/1999 Bailey et al. 378/4
6,304,629 B1 * 10/2001 Conway et al. 378/68
6,859,518 B2 * 2/2005 Banchieri et al. 378/57
7,072,434 B1 * 7/2006 Tybinkowski et al. 378/4
7,415,094 B2 * 8/2008 Johnson et al. 378/57
7,570,787 B2 * 8/2009 Hirose 382/110
D658,294 S * 4/2012 Awad D24/158
2008/0118026 A1 * 5/2008 Ainsworth et al. 378/20

* cited by examiner

Primary Examiner — Anhdao Doan

(74) *Attorney, Agent, or Firm* — Casimir Jones SC

(57) **CLAIM**

The ornamental design for an x-ray scanner, as shown and described.

DESCRIPTION

FIG. 1 is a perspective view showing our new design; FIG. 2 is a front elevational view thereof; FIG. 3 is a rear elevational view thereof; FIG. 4 is a top plan view thereof; FIG. 5 is a right side elevational view thereof; FIG. 6 is a left side elevational view thereof; and, FIG. 7 is a bottom plan view thereof. The broken lines in the drawing views are included for the purpose of illustrating unclaimed portions of the x-ray scanner and form no part of the claimed design.

1 Claim, 7 Drawing Sheets

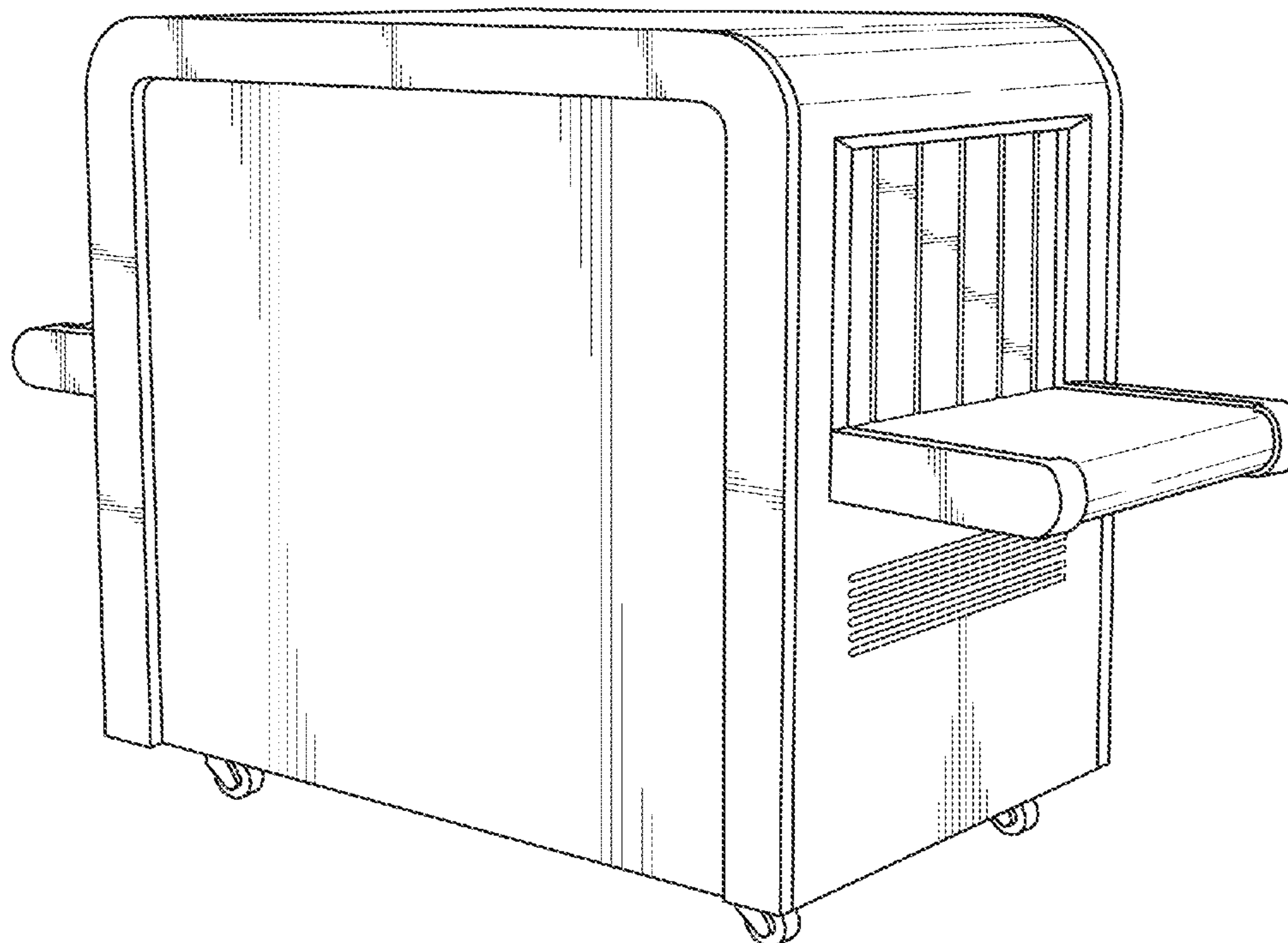

FIG. 1

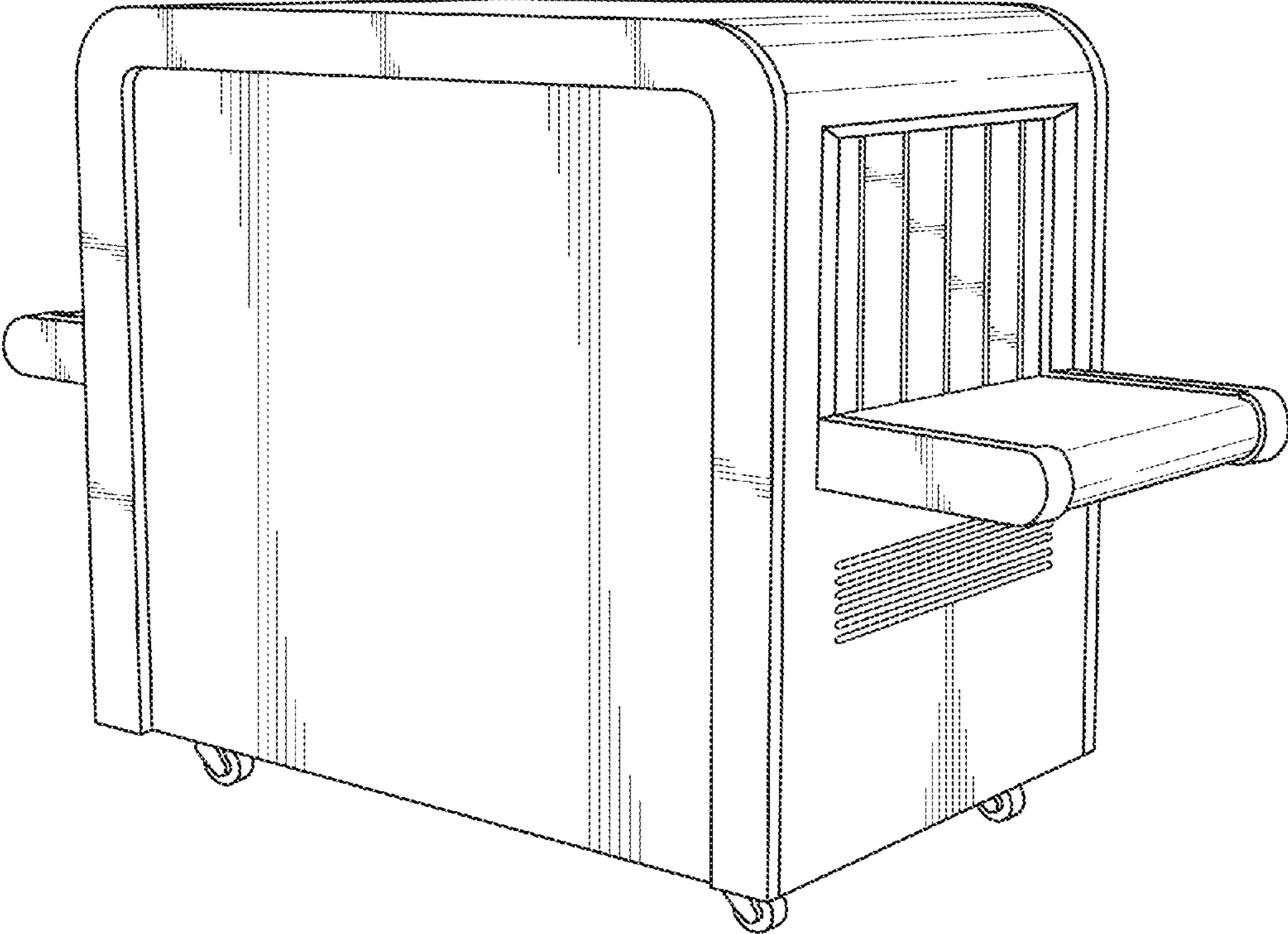

FIG. 2

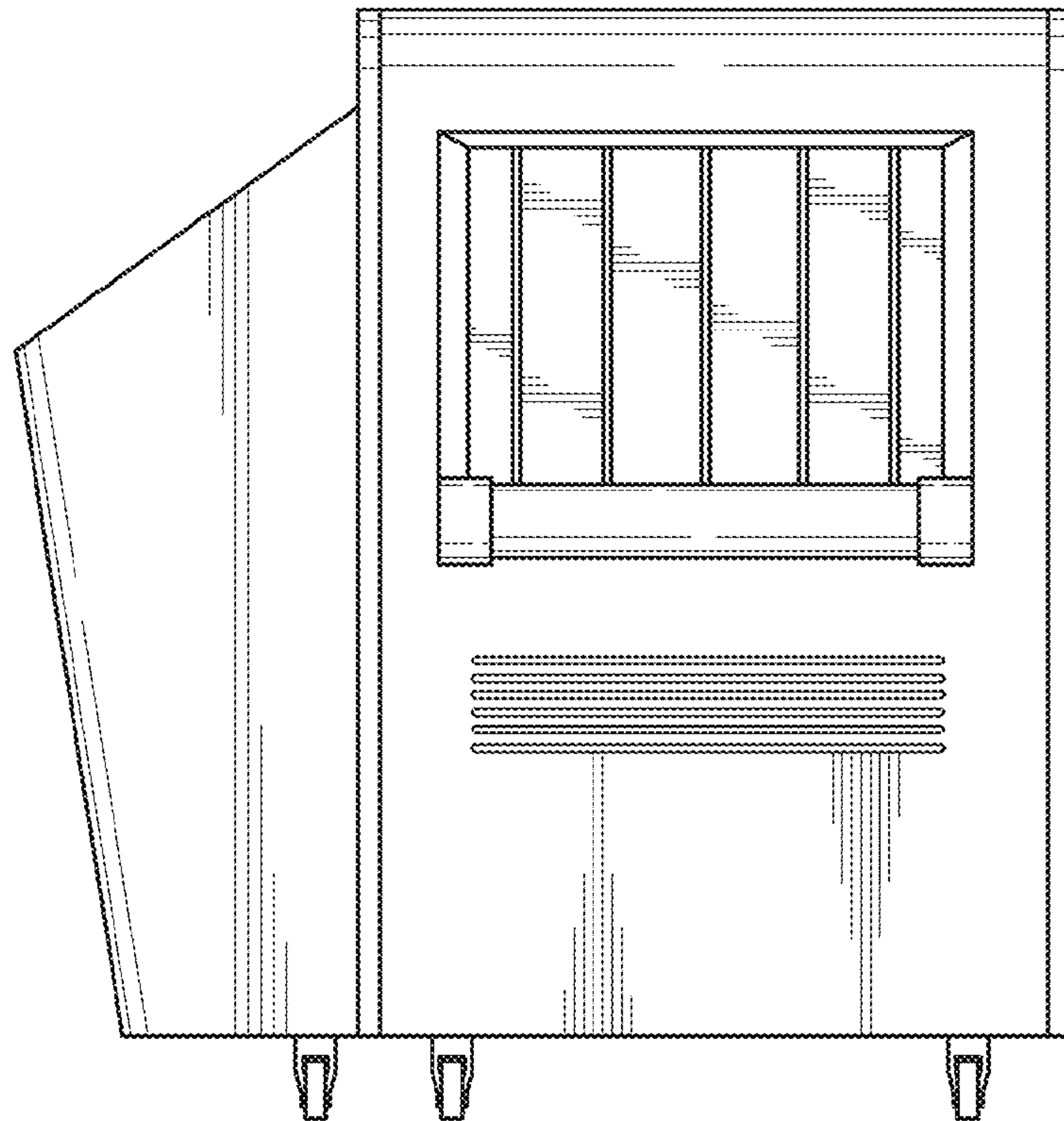

FIG. 3

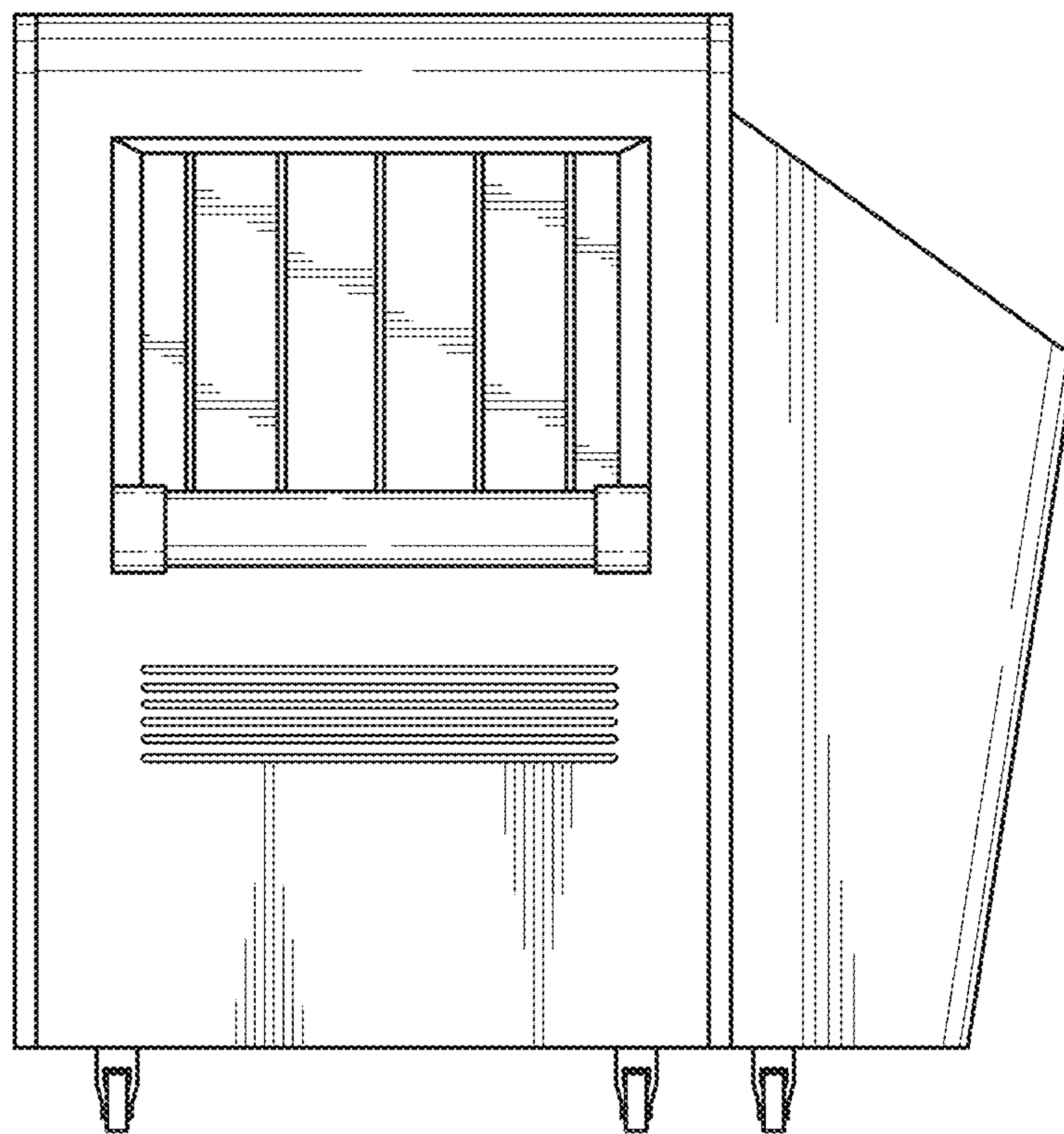

FIG. 4

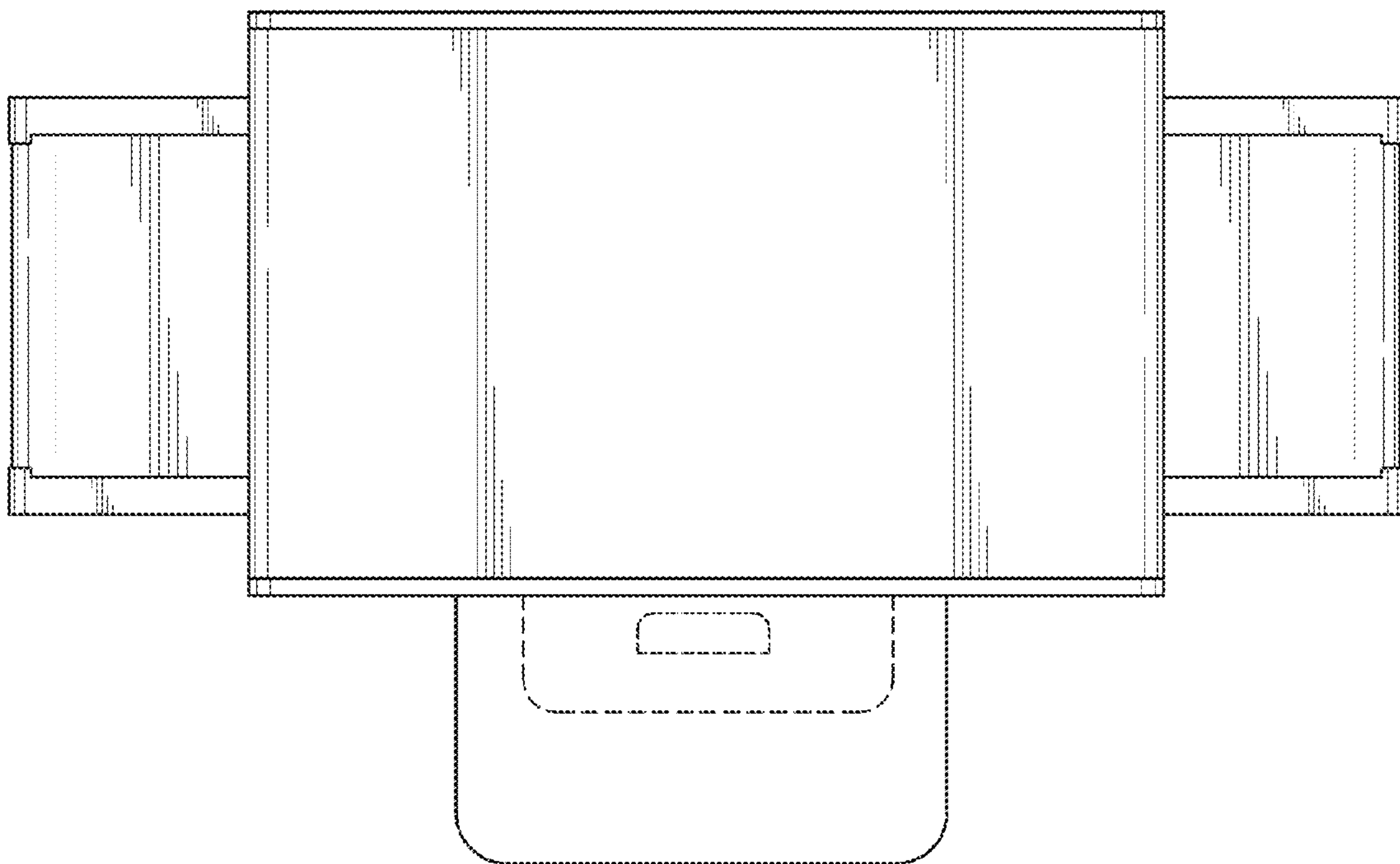

FIG. 5

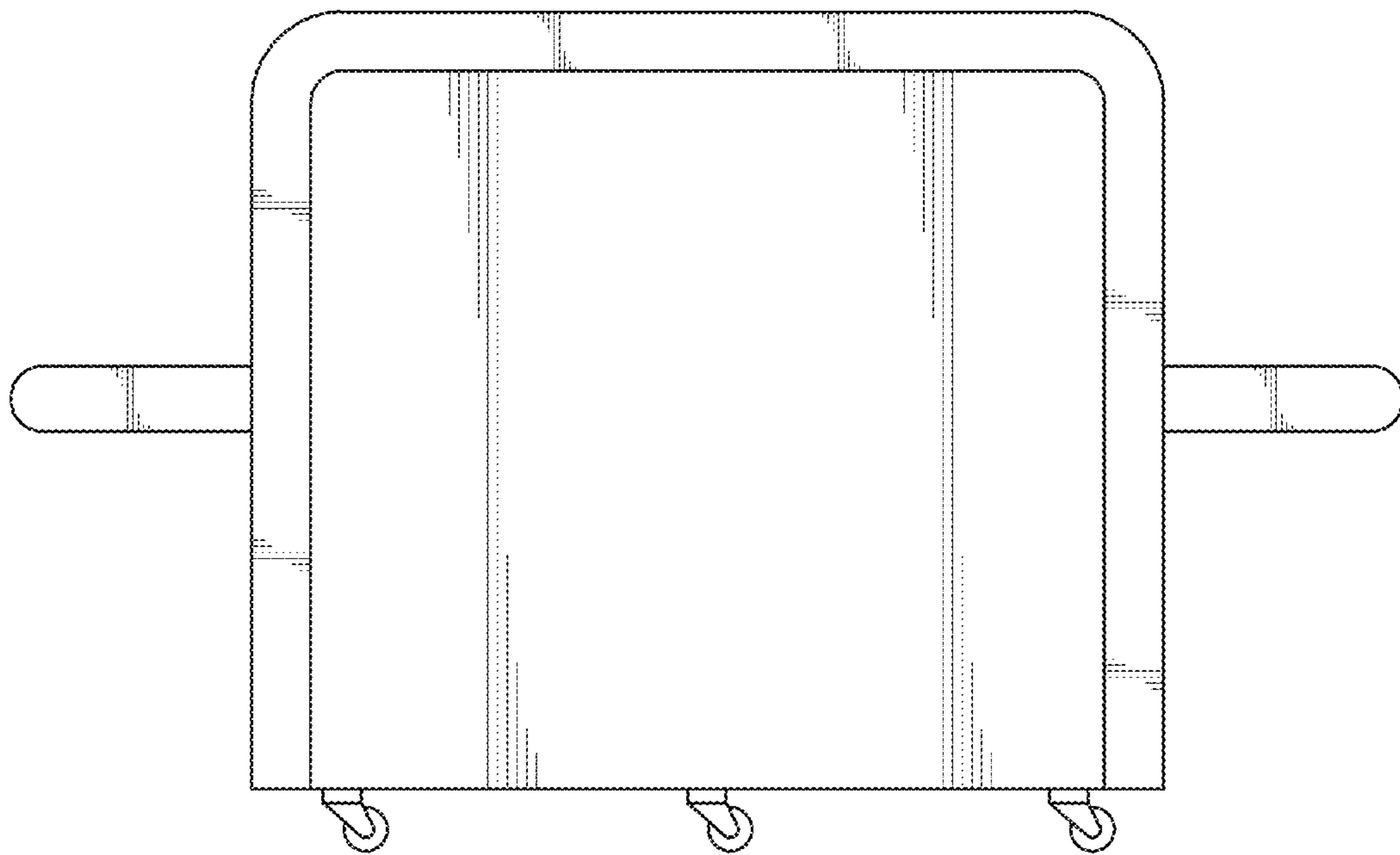

FIG. 6

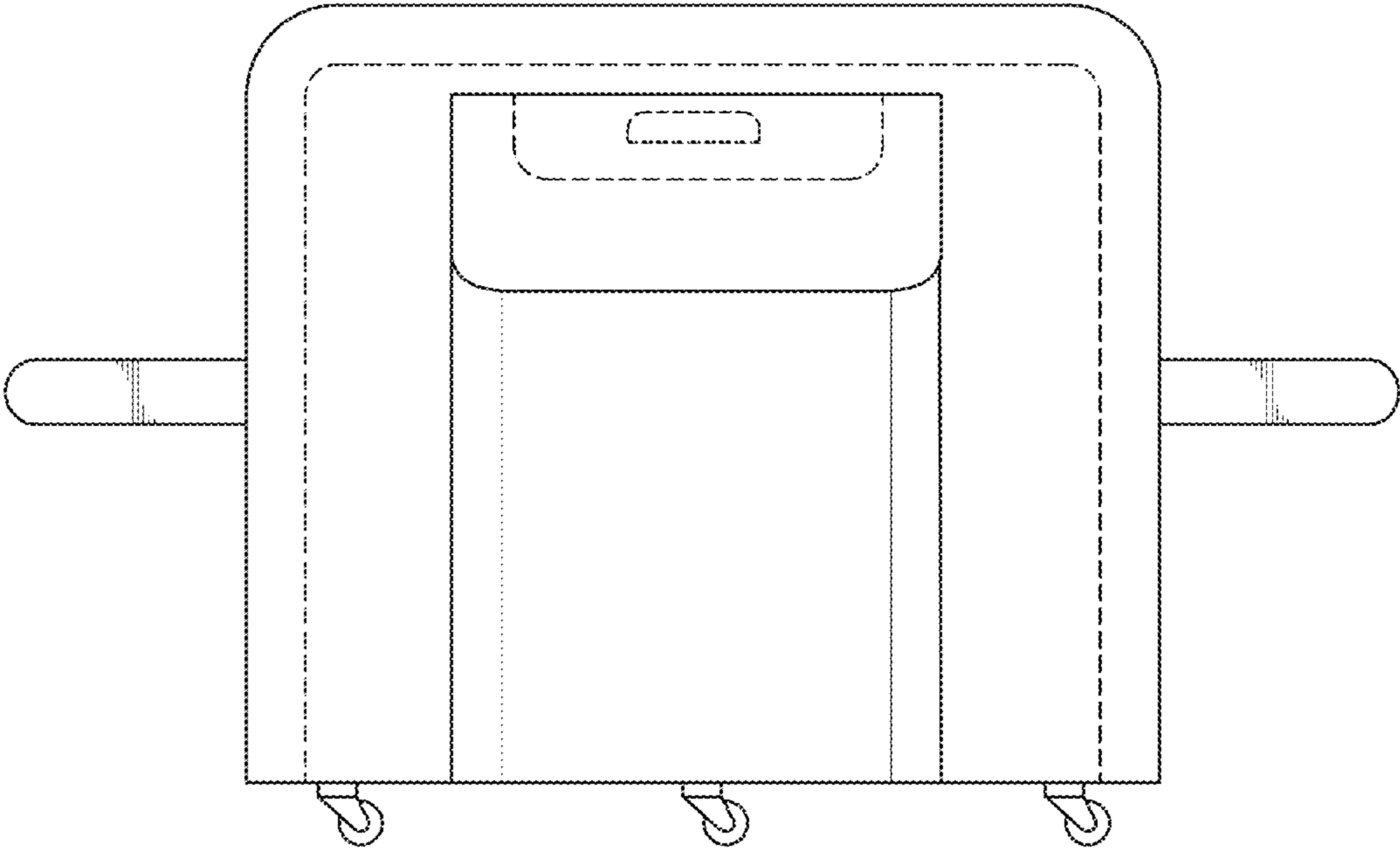

FIG. 7

