



US00D705874S

(12) **United States Design Patent**  
**Norman et al.**

(10) **Patent No.:** **US D705,874 S**  
(45) **Date of Patent:** **\*\* May 27, 2014**

(54) **PLATE CONNECTOR COMPONENT FOR A CONSTRUCTION KIT**

D693,416 S \* 11/2013 Webb ..... D21/486

\* cited by examiner

(71) Applicant: **Innovation First, Inc.**, Greenville, TX (US)

*Primary Examiner* — Cynthia M Chin

(74) *Attorney, Agent, or Firm* — Adam K. Sacharoff; Much Shelist

(72) Inventors: **David Anthony Norman**, Greenville, TX (US); **Robert H. Mimplitch, III**, Rowlett, TX (US); **Paul David Copioli**, Rockwall, TX (US); **Gregory James Lavender**, Rockwall, TX (US); **Aren Calder Hill**, Rockford, IL (US); **Douglas Michael Galletti**, Allen, TX (US); **John Edward Vielkind-Neun**, Rockwall, TX (US); **Arthur Philip Dutra, IV**, Greenville, TX (US)

(57) **CLAIM**

The ornamental design for a plate connector component for a construction kit, as shown and described.

**DESCRIPTION**

(73) Assignee: **Innovation First, Inc.**, Greenville, TX (US)

FIG. 1 is a front perspective view of a plate connector component for a construction kit in accordance with a First Embodiment;

FIG. 2 is a cross-sectional view of FIG. 1 taken of line 2-2 from FIG. 1;

FIG. 3 is a rear perspective view of FIG. 1;

FIG. 4 is a top side perspective view of FIG. 1;

FIG. 5 is a bottom side view of FIG. 1;

FIG. 6 is a right side view of FIG. 1;

FIG. 7 is a left side view of FIG. 1;

FIG. 8 is a front side view of FIG. 1;

FIG. 9 is a rear side view of FIG. 1;

FIG. 10 is a front perspective view of a plate connector component for a construction kit in accordance with another Embodiment;

FIG. 11 is a cross-sectional view of FIG. 10 taken of line 11-11 from FIG. 10;

FIG. 12 is a rear perspective view of FIG. 10;

FIG. 13 is a top side perspective view of FIG. 10;

FIG. 14 is a bottom side view of FIG. 10;

FIG. 15 is a right side view of FIG. 10;

FIG. 16 is a left side view of FIG. 10;

FIG. 17 is a front side view of FIG. 10;

FIG. 18 is a rear side view of FIG. 10;

FIG. 19 is a front perspective view of a plate connector component for a construction kit in accordance with another Embodiment;

FIG. 20 is a sectional view of FIG. 19 taken of line 28-28 from FIG. 19;

FIG. 21 is a top side perspective view of FIG. 19;

FIG. 22 is a bottom side view of FIG. 19;

(\*\*) Term: **14 Years**

(21) Appl. No.: **29/451,494**

(22) Filed: **Apr. 3, 2013**

(51) **LOC (10) Cl.** ..... **21-01**

(52) **U.S. Cl.**  
USPC ..... **D21/491**; D21/500

(58) **Field of Classification Search**  
USPC ..... D21/484, 485, 486, 488, 489, 491, 494, D21/495, 499, 500-504; 446/69, 85, 446/102-128; 434/208, 259, 403; 273/153, 273/156, 160; 428/174

See application file for complete search history.

(56) **References Cited**

U.S. PATENT DOCUMENTS

D219,230 S *	11/1970	Reijnhard	.....	D21/491
D285,583 S *	9/1986	Kassai	.....	D21/491
D352,750 S *	11/1994	Kushner et al.	.....	D21/485
D370,035 S *	5/1996	Olsen	.....	D21/491
D385,926 S *	11/1997	Nielsen	.....	D21/485
D426,933 S *	6/2000	Redfern	.....	D21/491
8,002,241 B1 *	8/2011	Shaw	.....	254/88

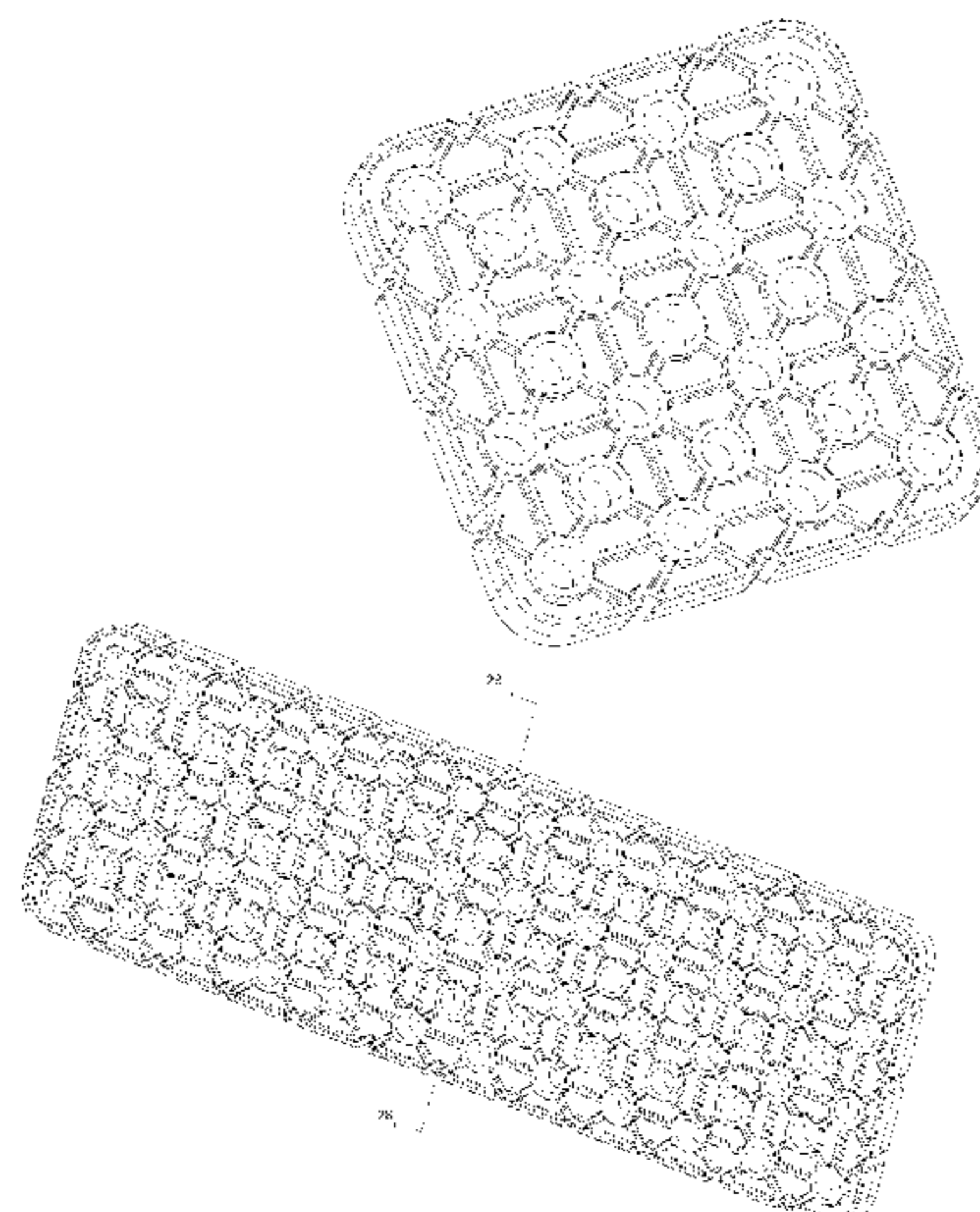

FIG. 23 is a right side view of FIG. 19;  
FIG. 24 is a left side view of FIG. 19;  
FIG. 25 is a front side view of FIG. 19;  
FIG. 26 is a rear side view of FIG. 19;  
FIG. 27 is a front perspective view of a plate connector component for a construction kit in accordance with another Embodiment;  
FIG. 28 is a sectional view of FIG. 27 taken of line 28-28 from FIG. 27;  
FIG. 29 is a top side perspective view of FIG. 27;  
FIG. 30 is a bottom side view of FIG. 27;  
FIG. 31 is a right side view of FIG. 27;  
FIG. 32 is a left side view of FIG. 27;

FIG. 33 is a front side view of FIG. 27;  
FIG. 34 is a rear side view of FIG. 27;  
FIG. 35 is a front perspective view of a plate connector component for a construction kit in accordance with another Embodiment;  
FIG. 36 is a rear perspective view of FIG. 35;  
FIG. 37 is a top side perspective view of FIG. 35;  
FIG. 38 is a bottom side view of FIG. 35;  
FIG. 39 is a right side view of FIG. 35;  
FIG. 40 is a left side view of FIG. 35;  
FIG. 41 is a front side view of FIG. 35; and,  
FIG. 42 is a rear side view of FIG. 35.

**1 Claim, 42 Drawing Sheets**

FIGURE 1

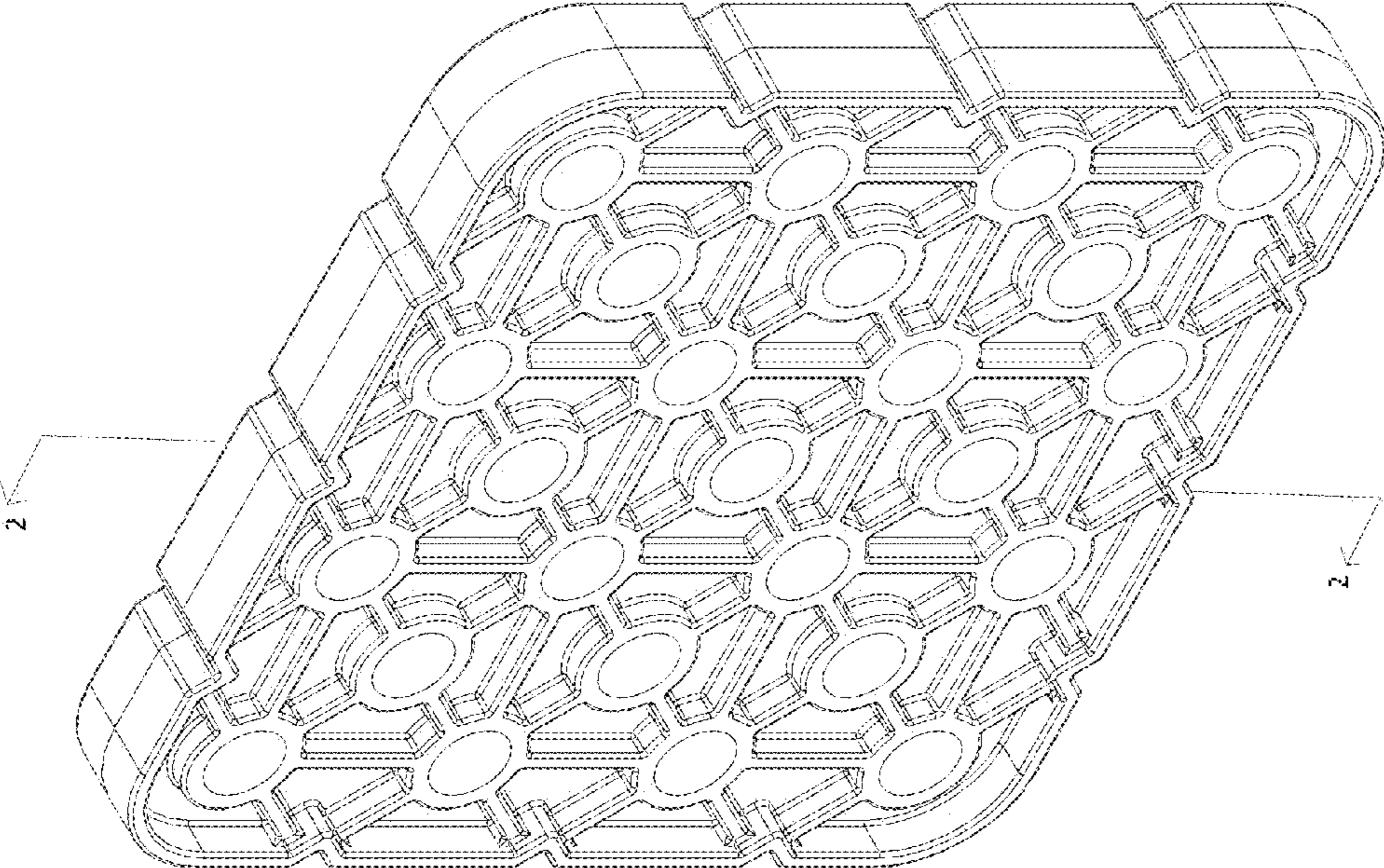



FIGURE 2

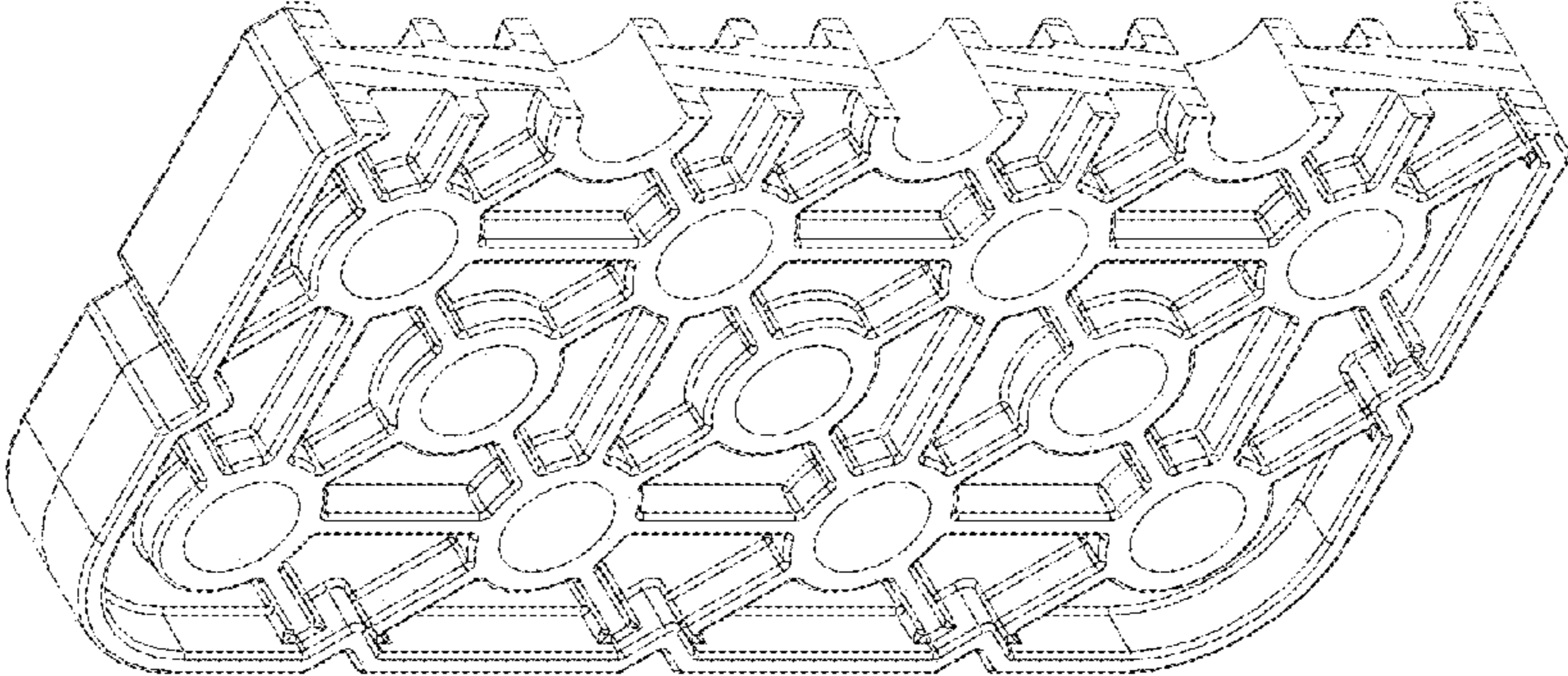

FIGURE 3

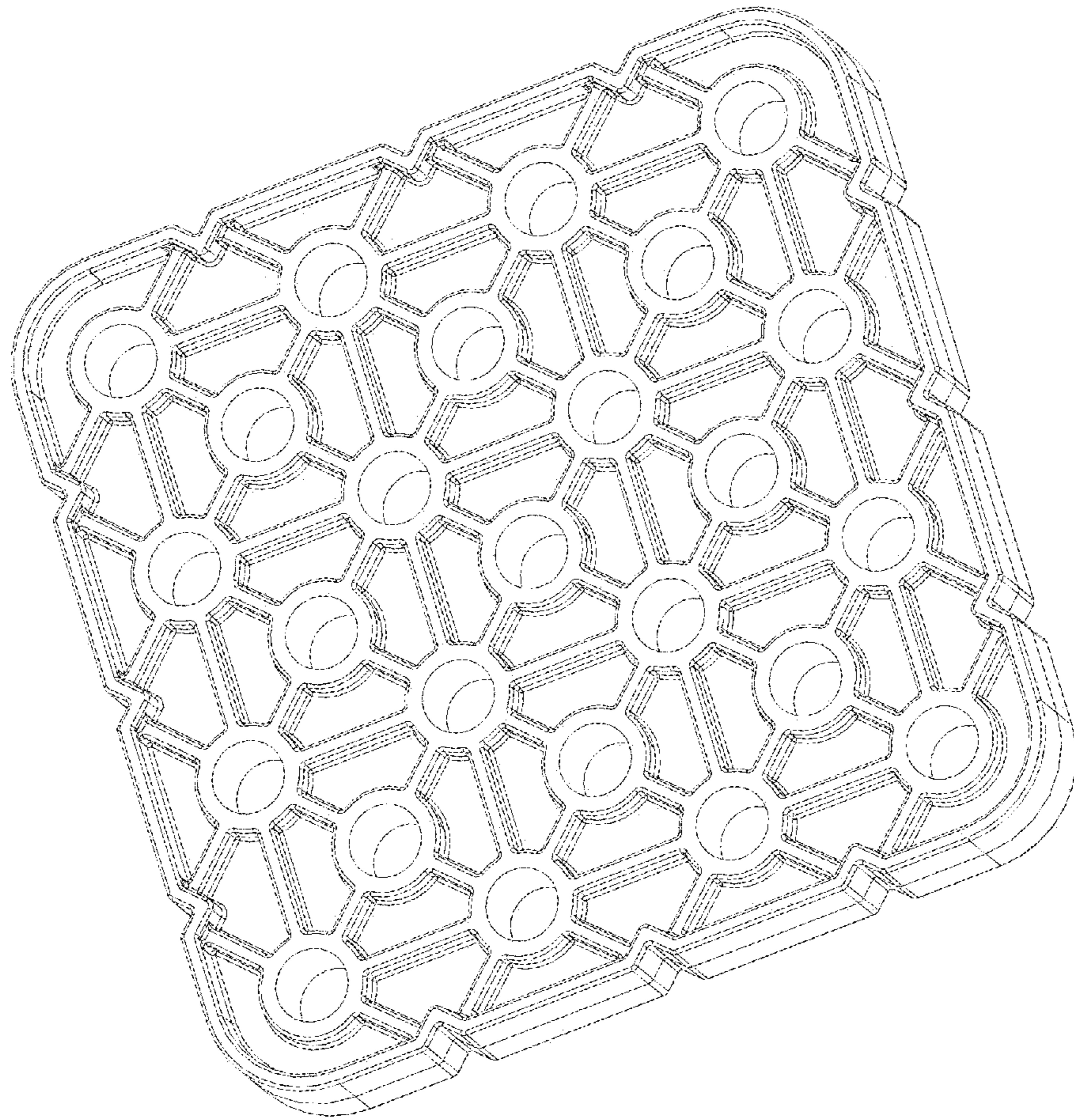

FIGURE 4

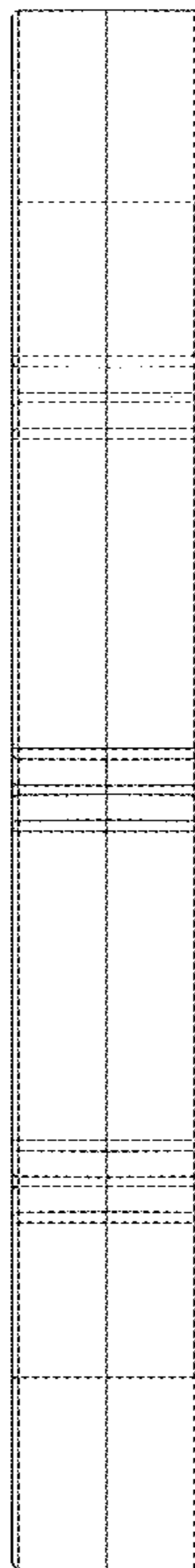

FIGURE 5

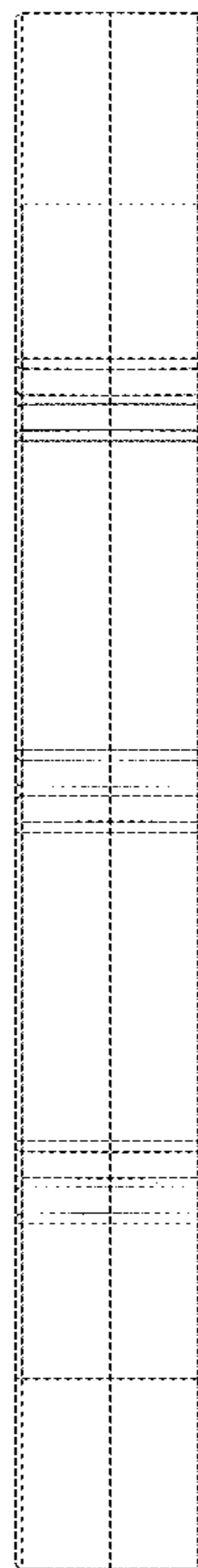

FIGURE 6

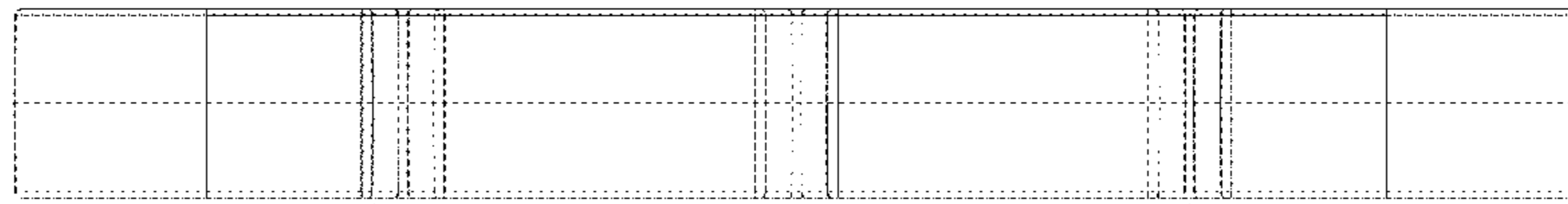



FIGURE 7

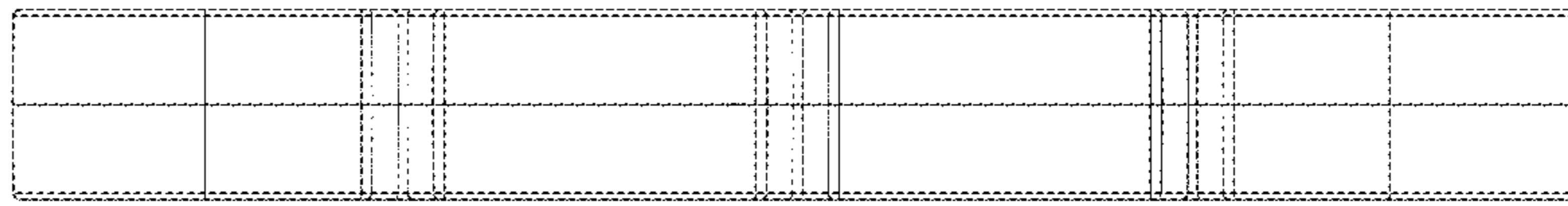

FIGURE 8

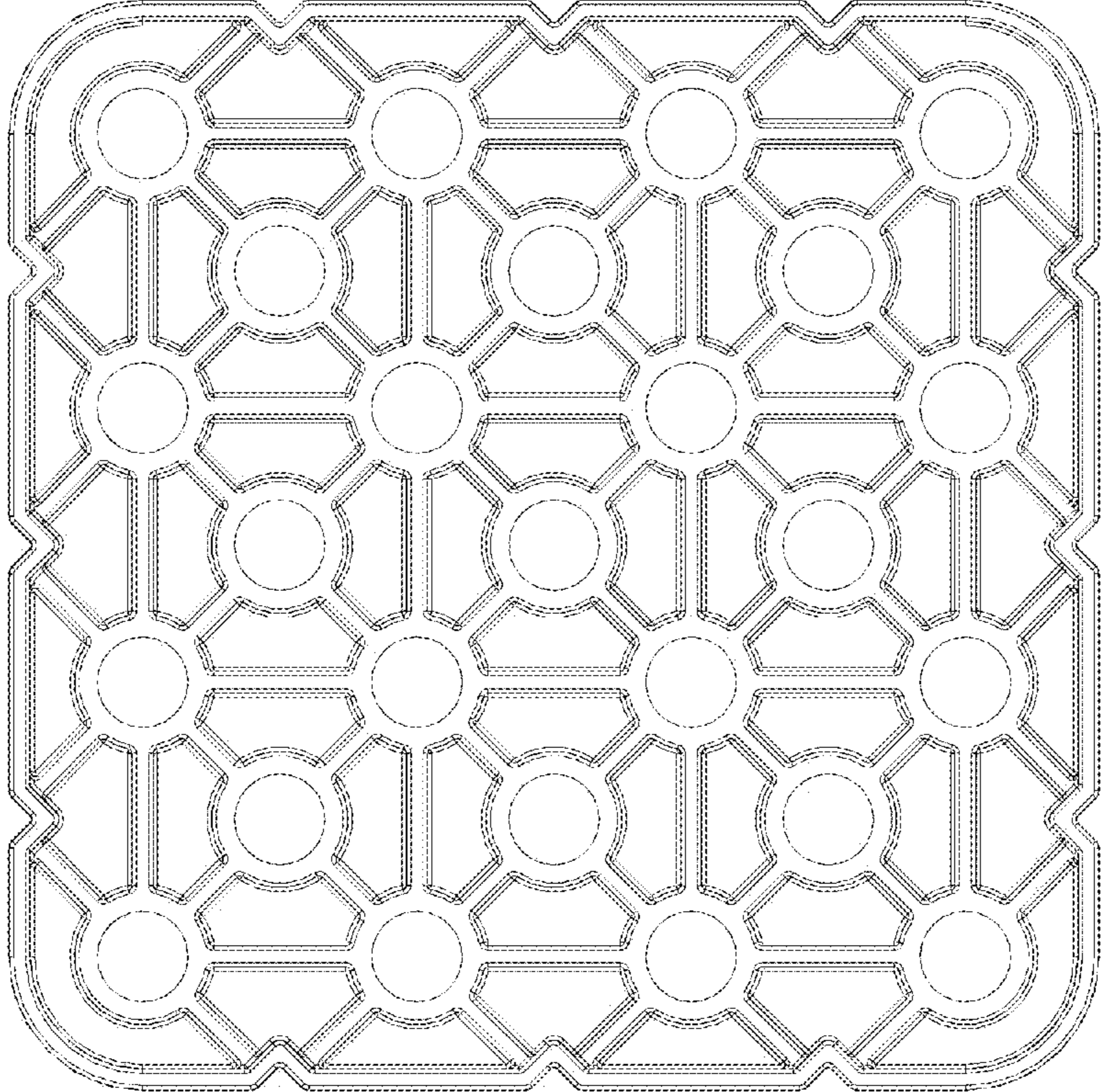

FIGURE 9

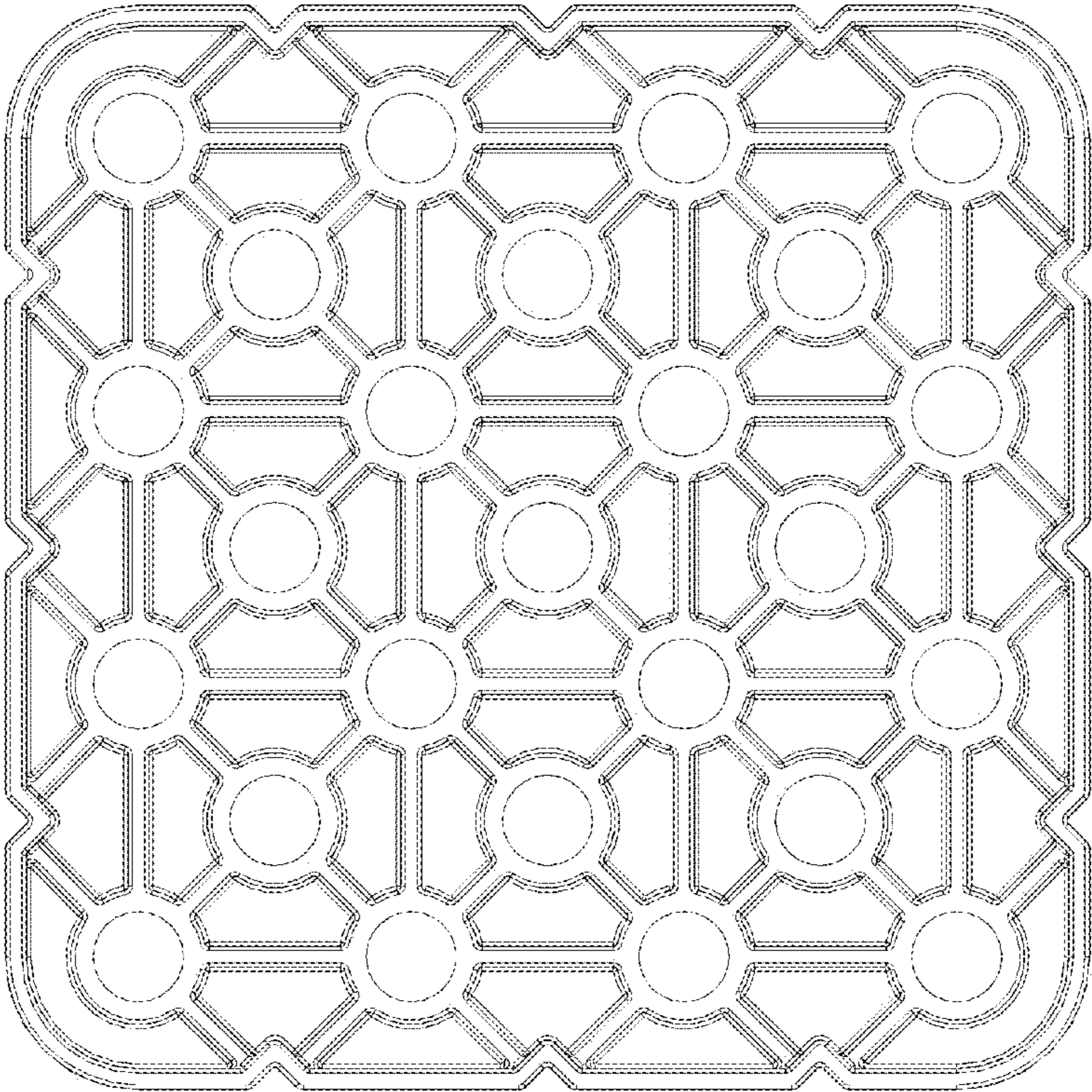



FIGURE 10

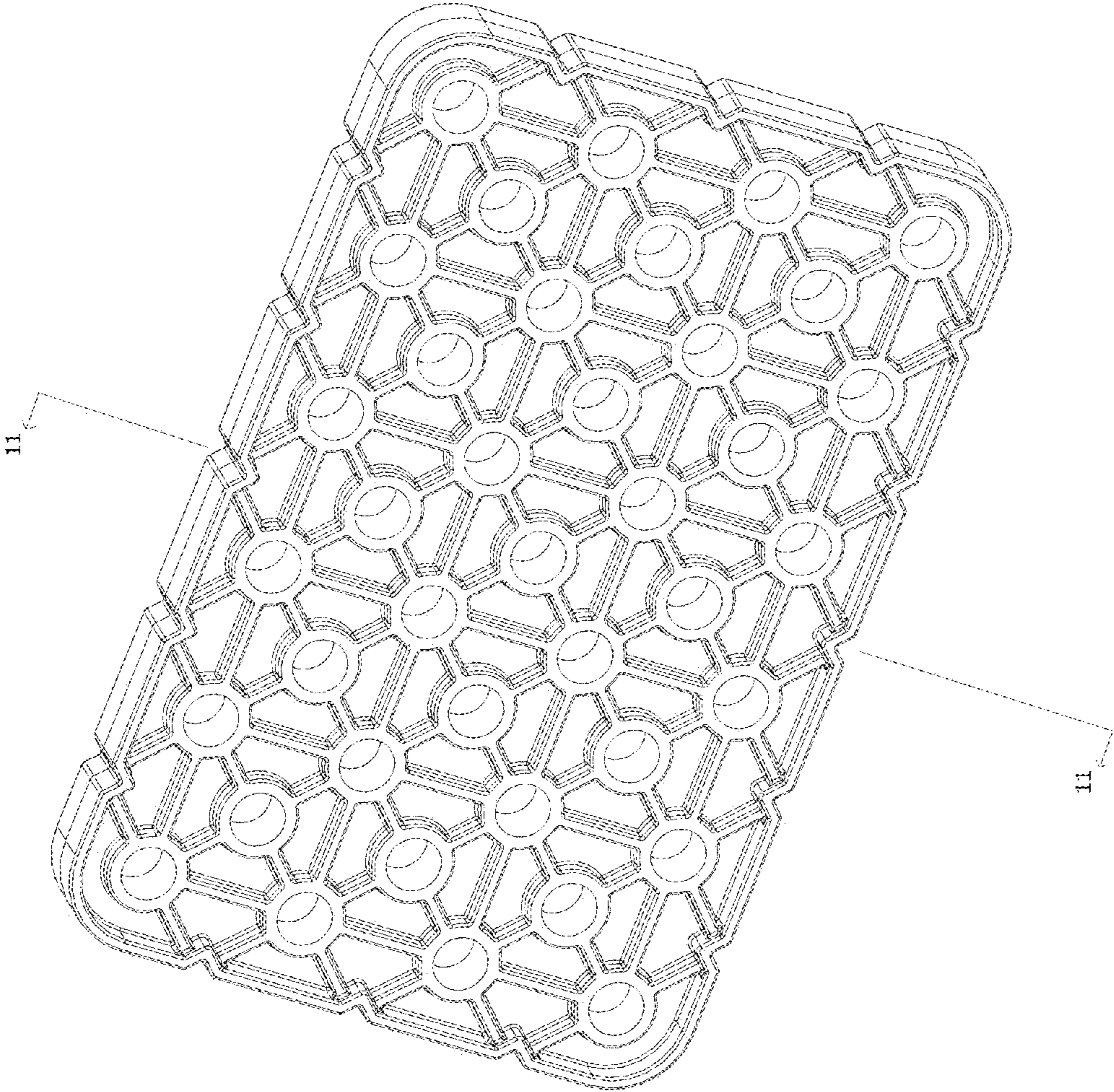



FIGURE 11

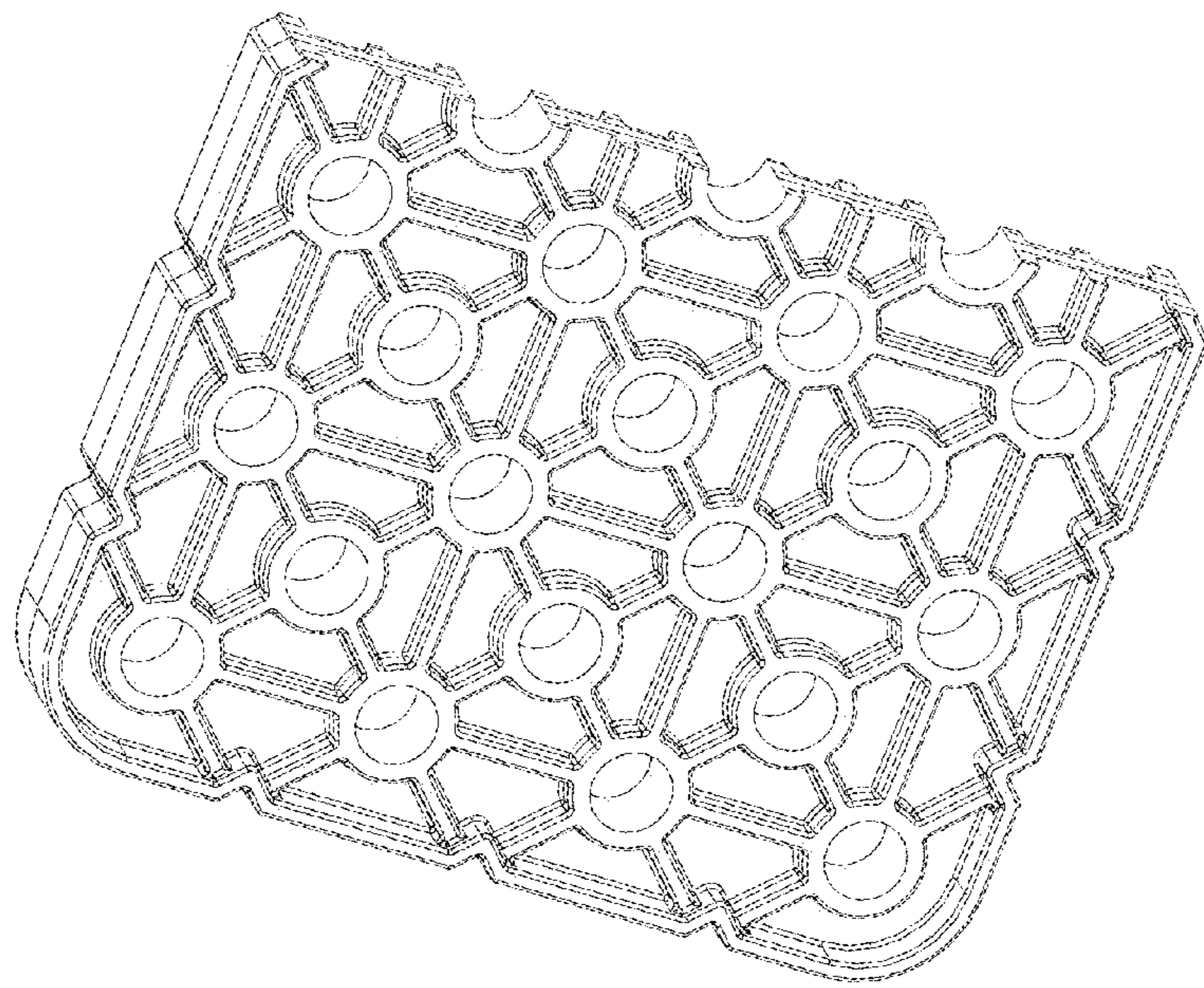

FIGURE 12



FIGURE 13

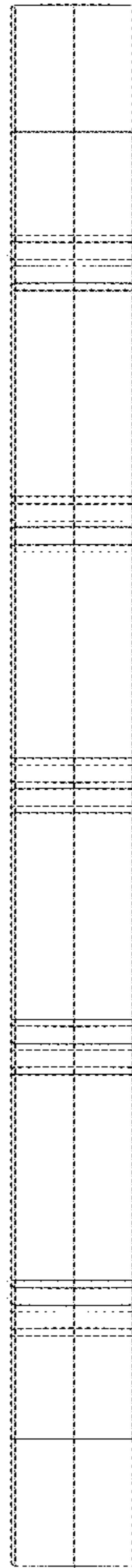

FIGURE 14

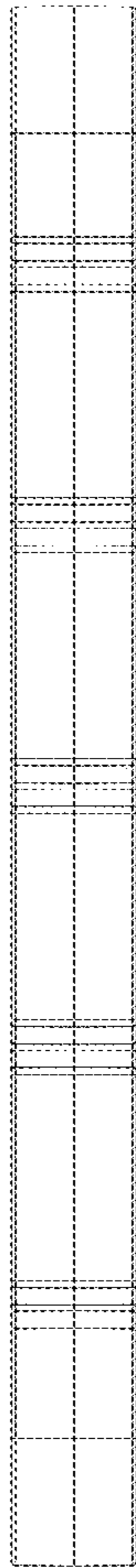



FIGURE 15

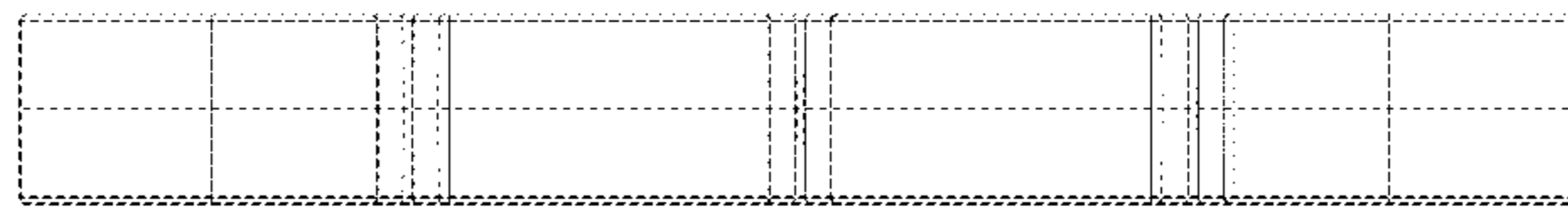

FIGURE 16

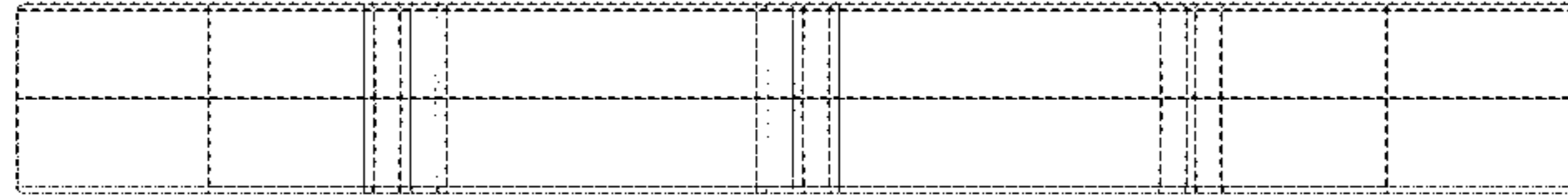

FIGURE 17

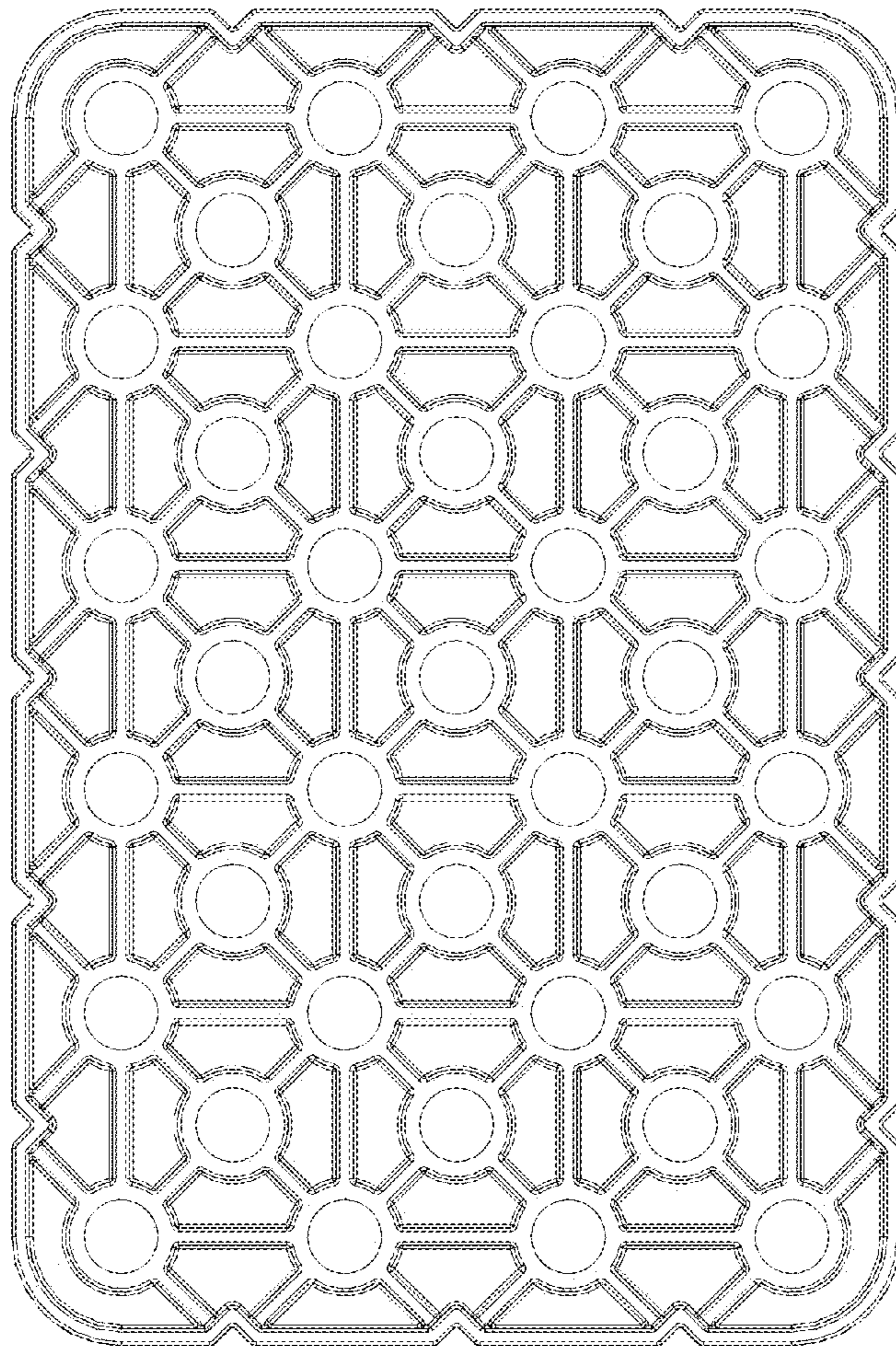

FIGURE 18

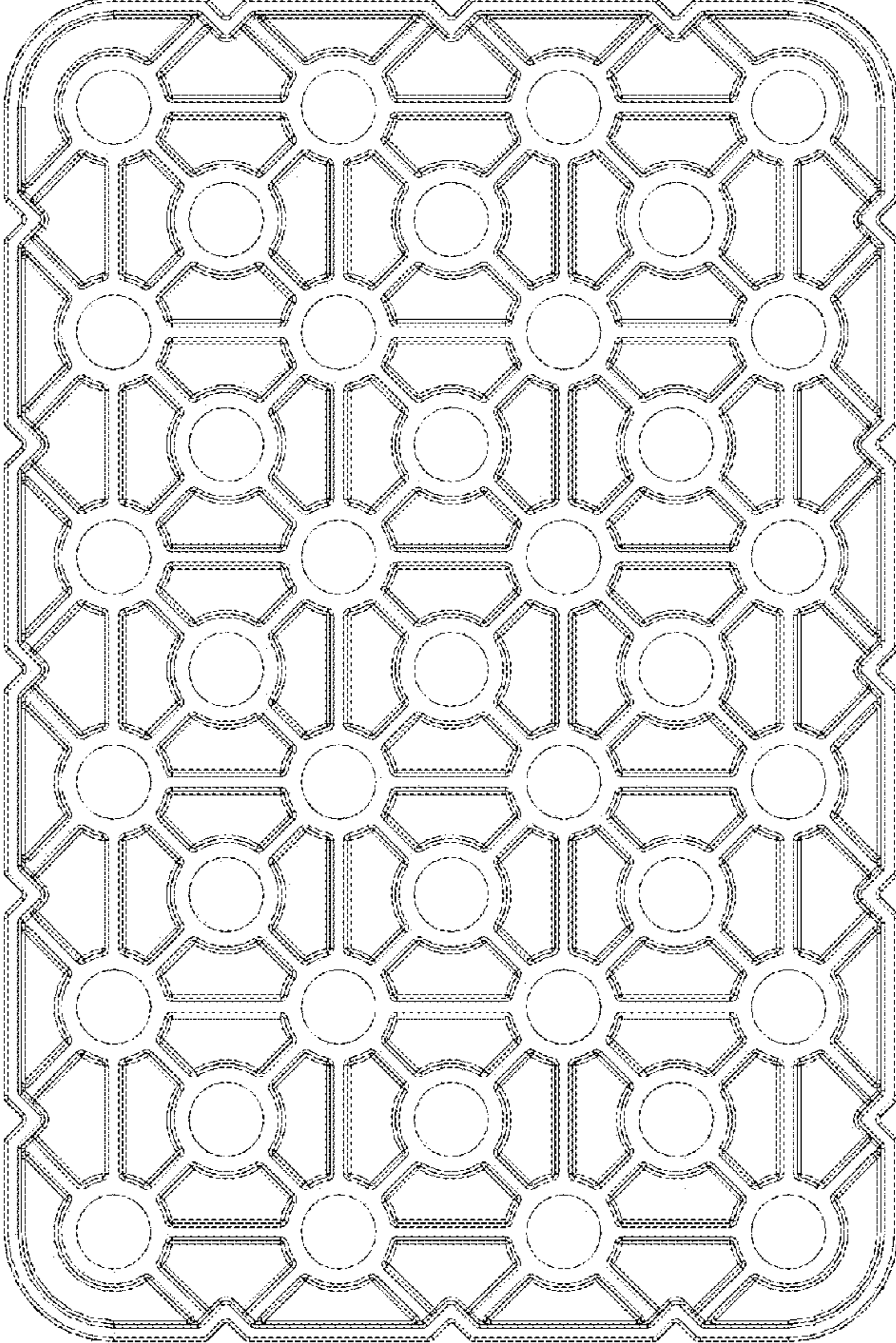



FIGURE 19

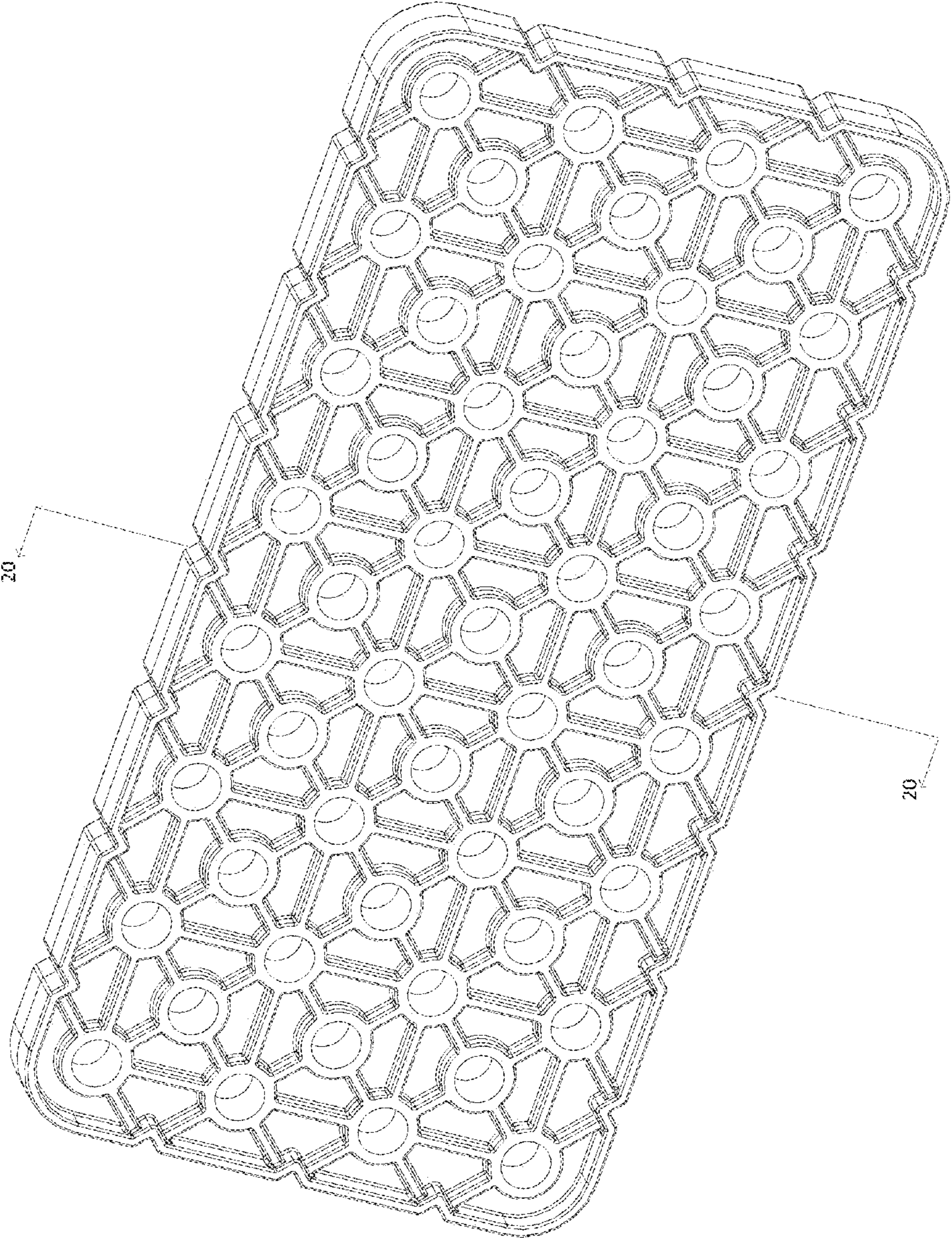

FIGURE 20

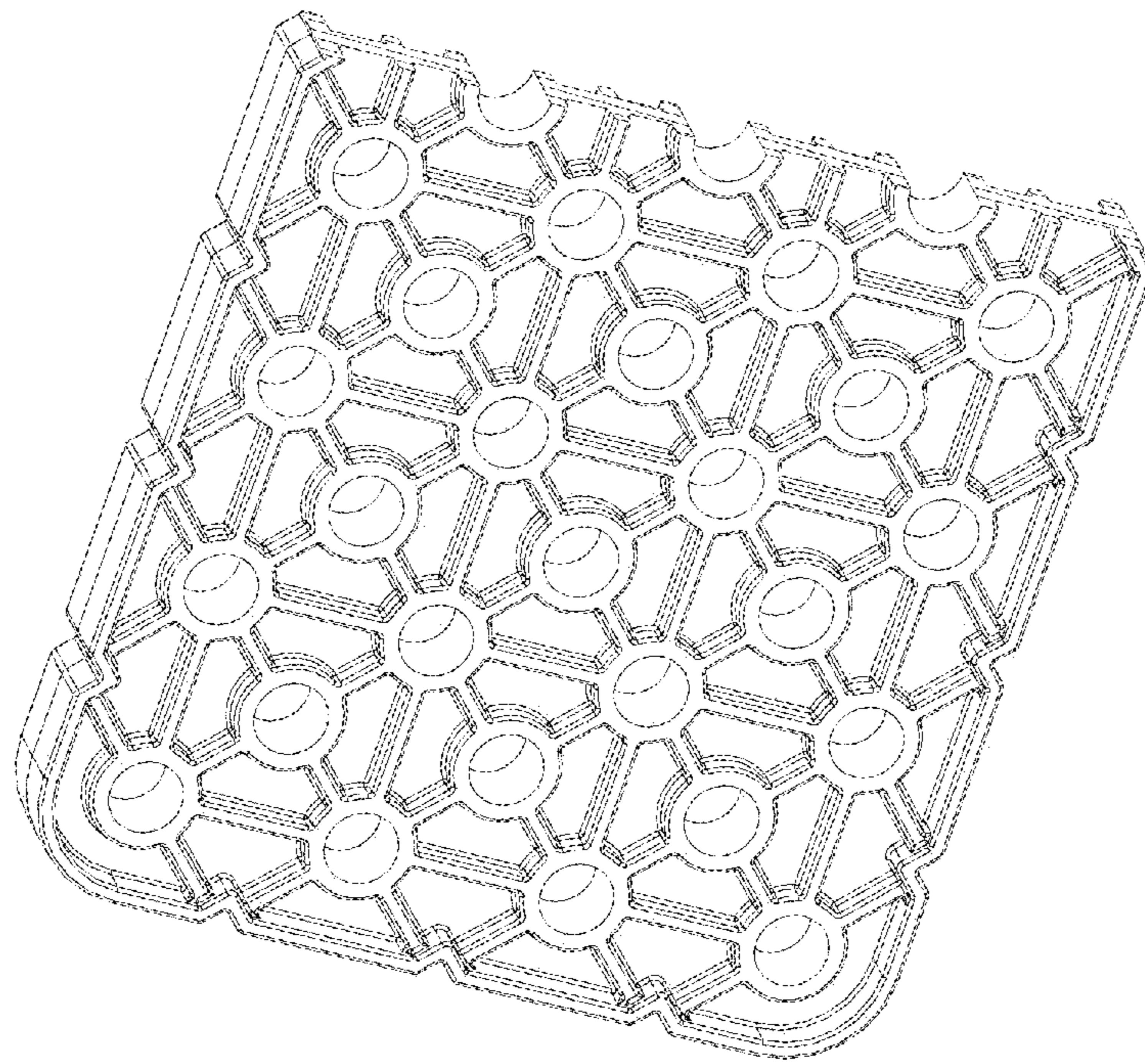

FIGURE 21

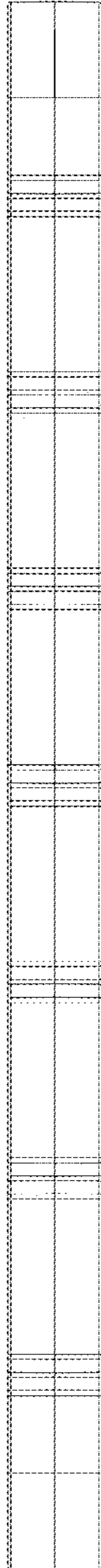



FIGURE 22

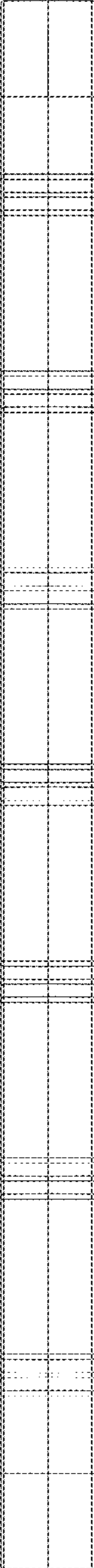



FIGURE 23

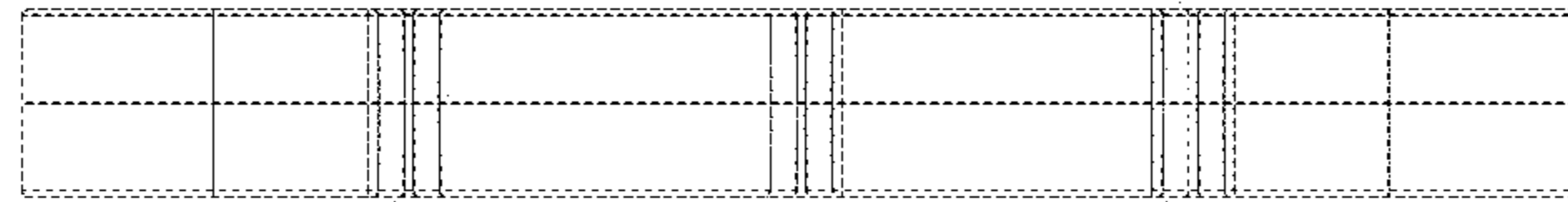

FIGURE 24

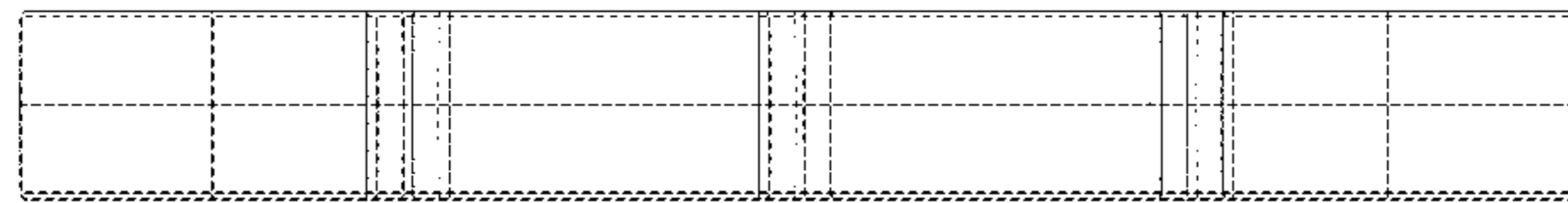

FIGURE 25

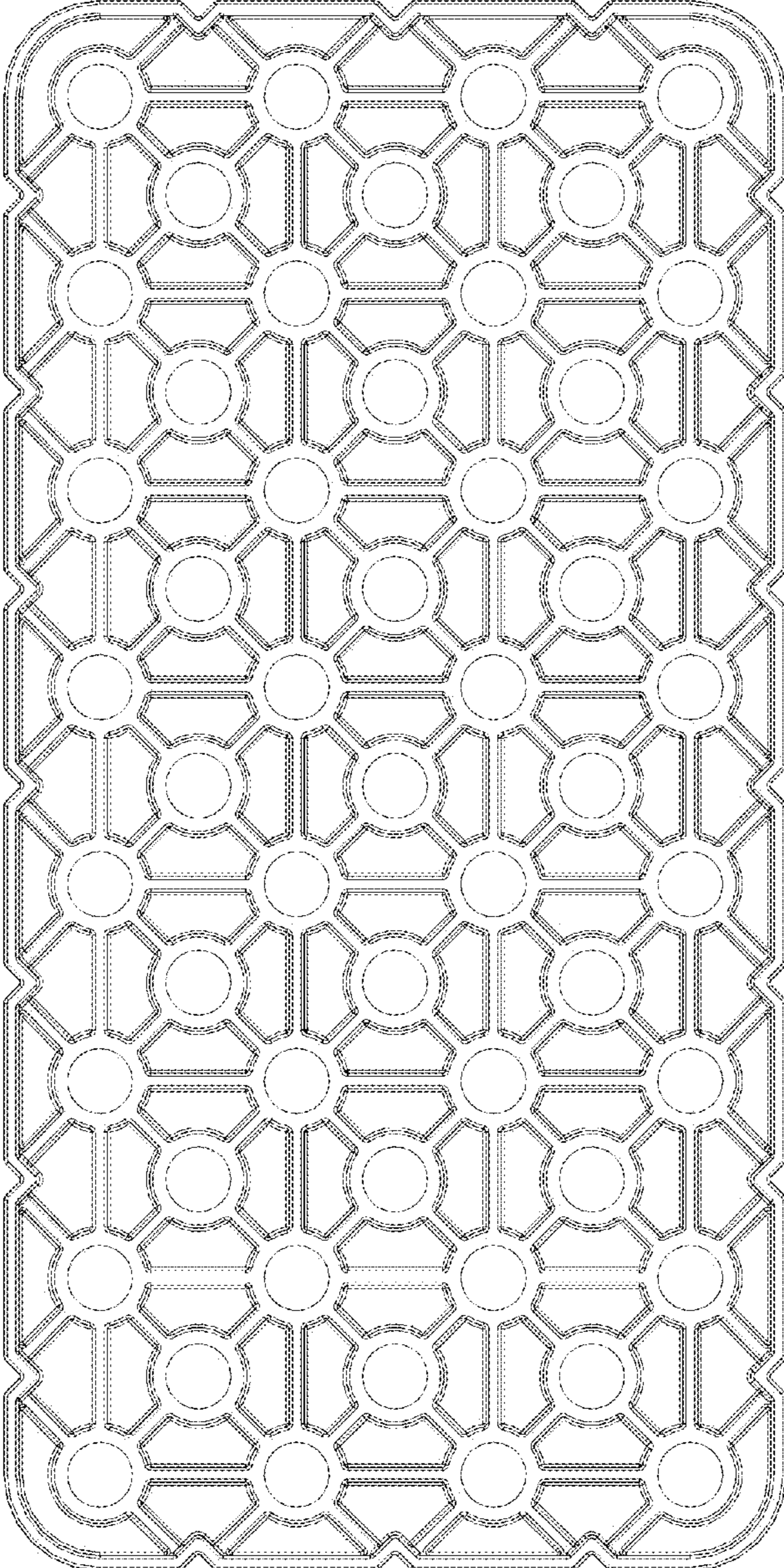



FIGURE 26

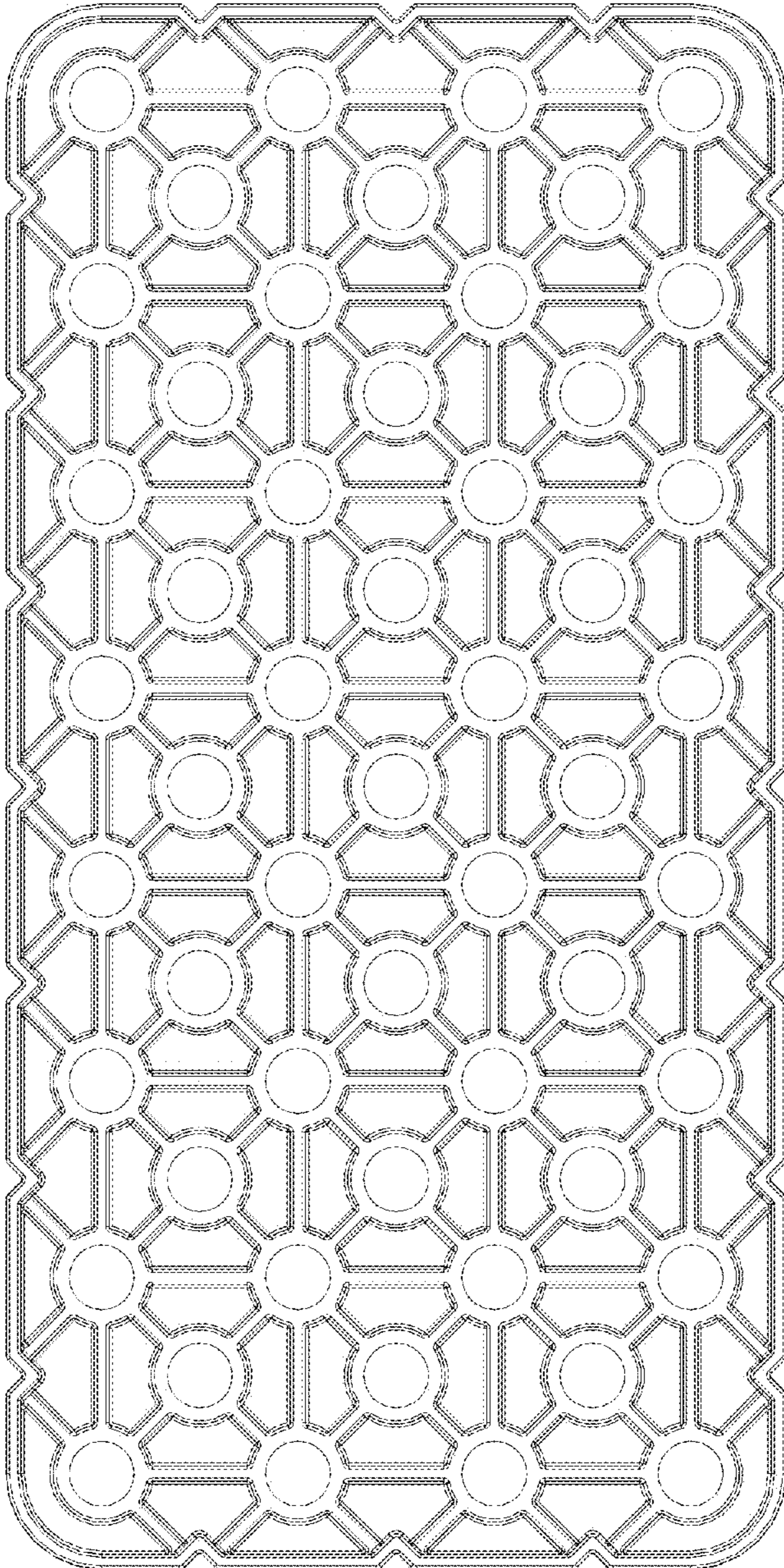



FIGURE 27

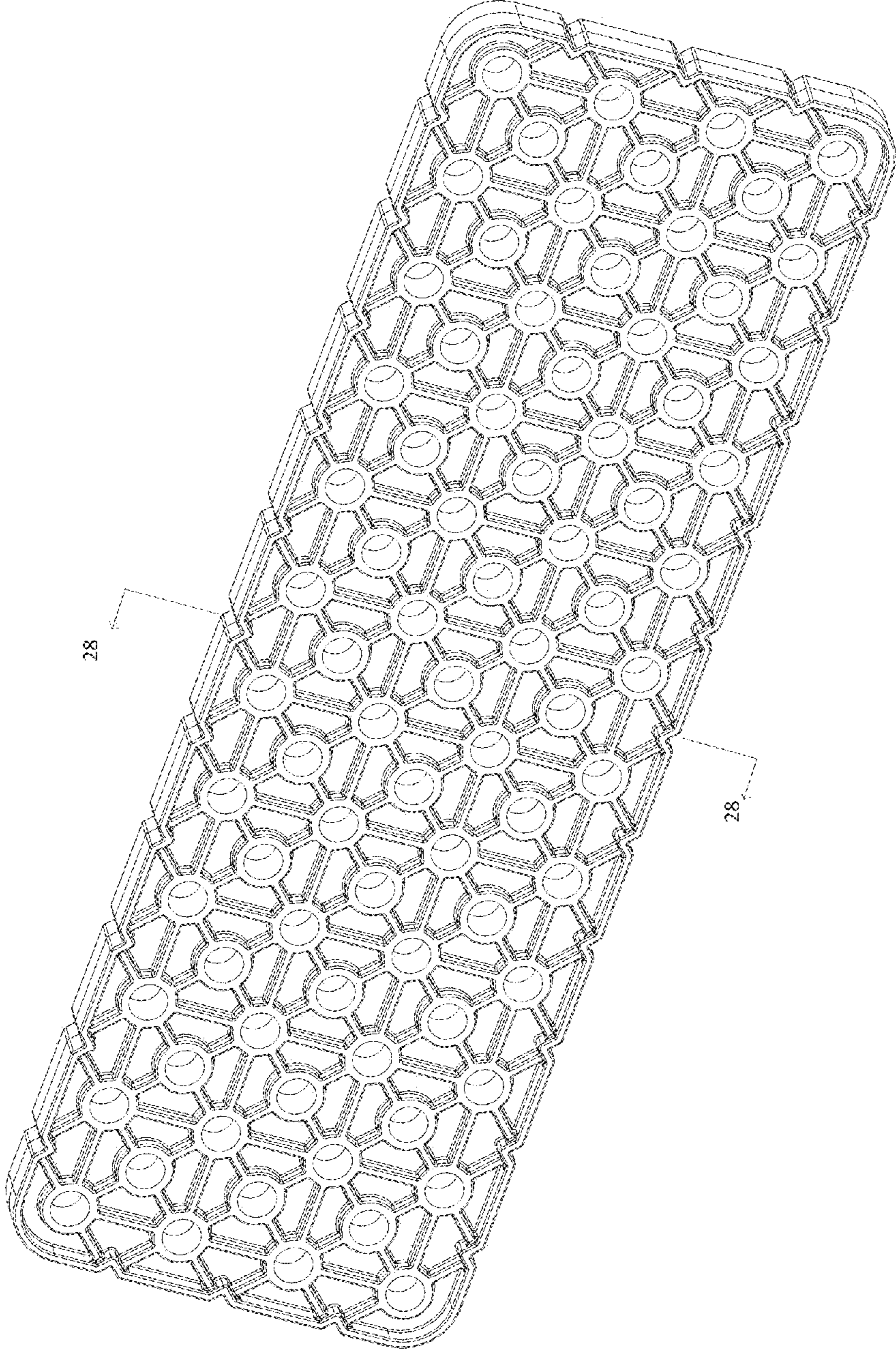

FIGURE 28

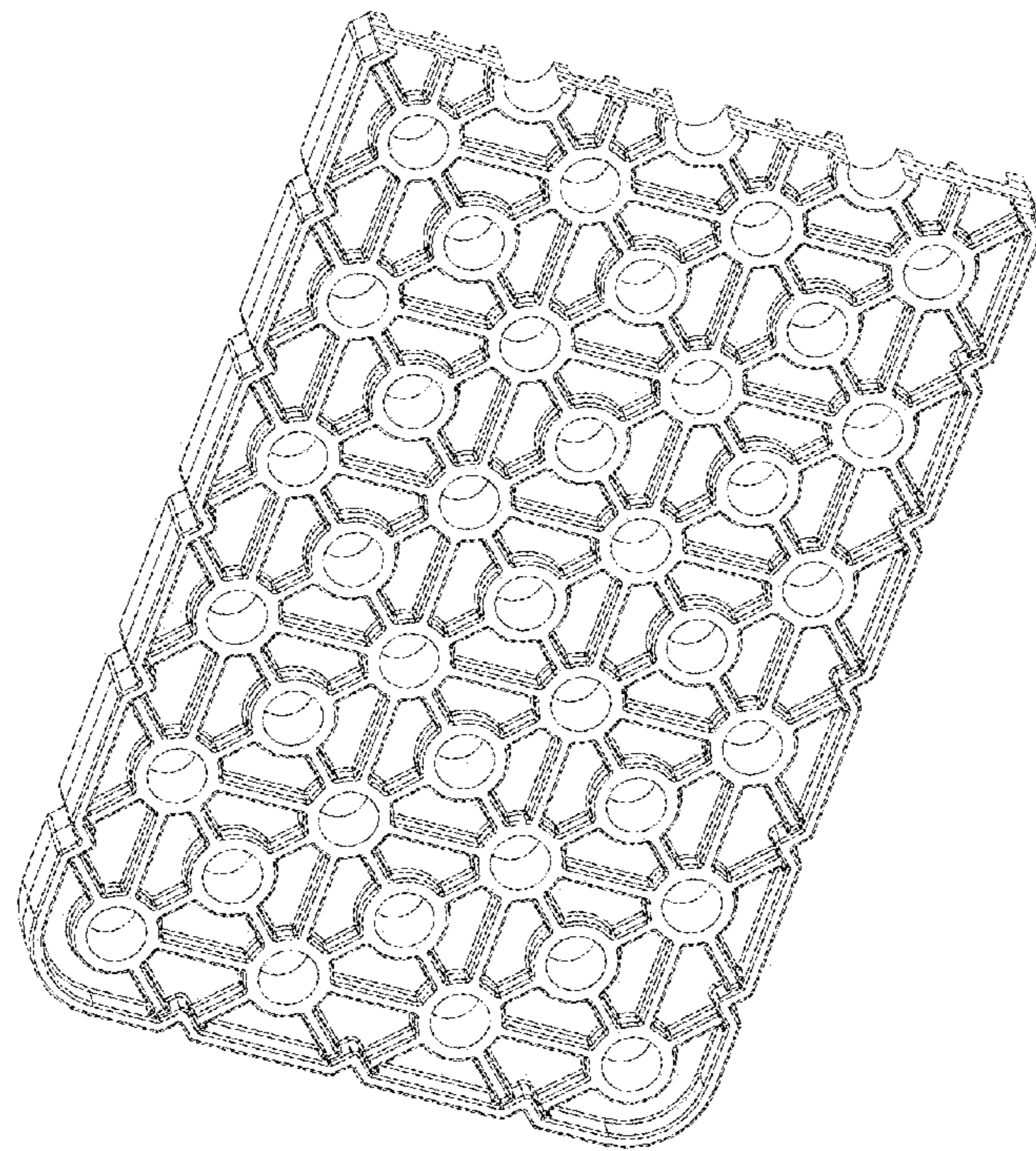

FIGURE 29

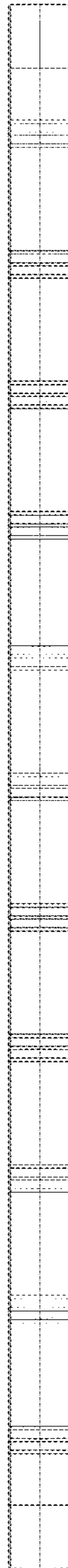



FIGURE 30





FIGURE 31

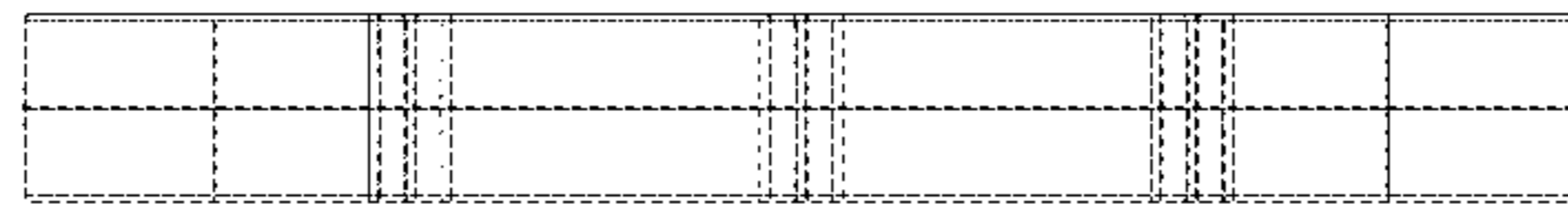

FIGURE 32

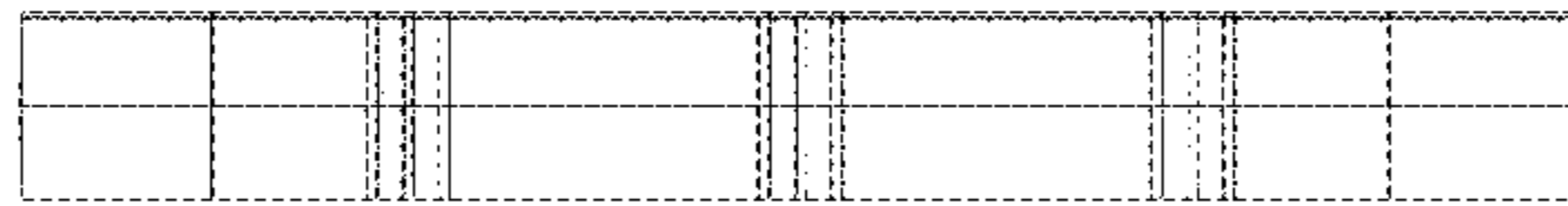

FIGURE 33

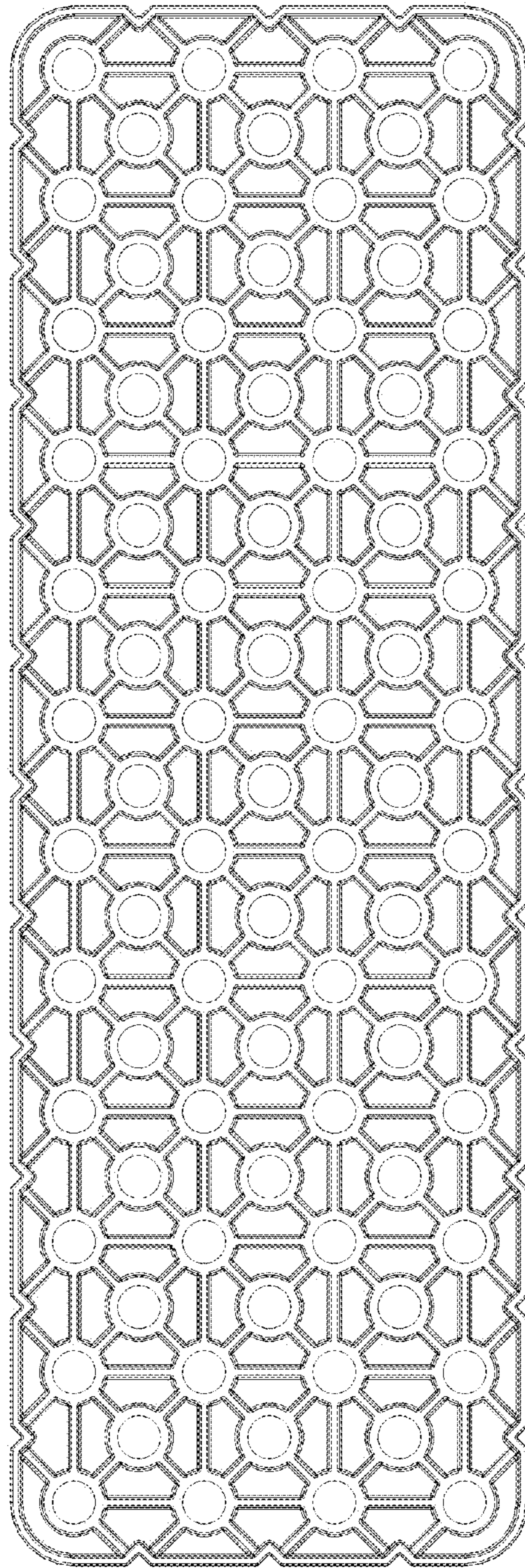



FIGURE 34

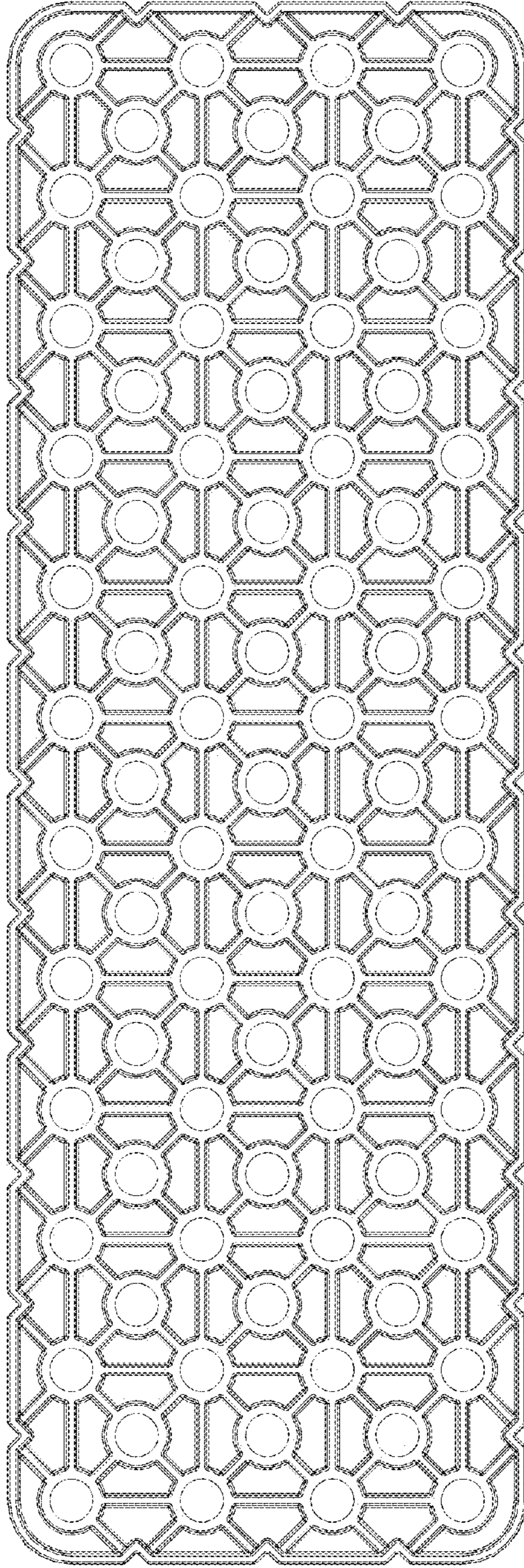



FIGURE 35

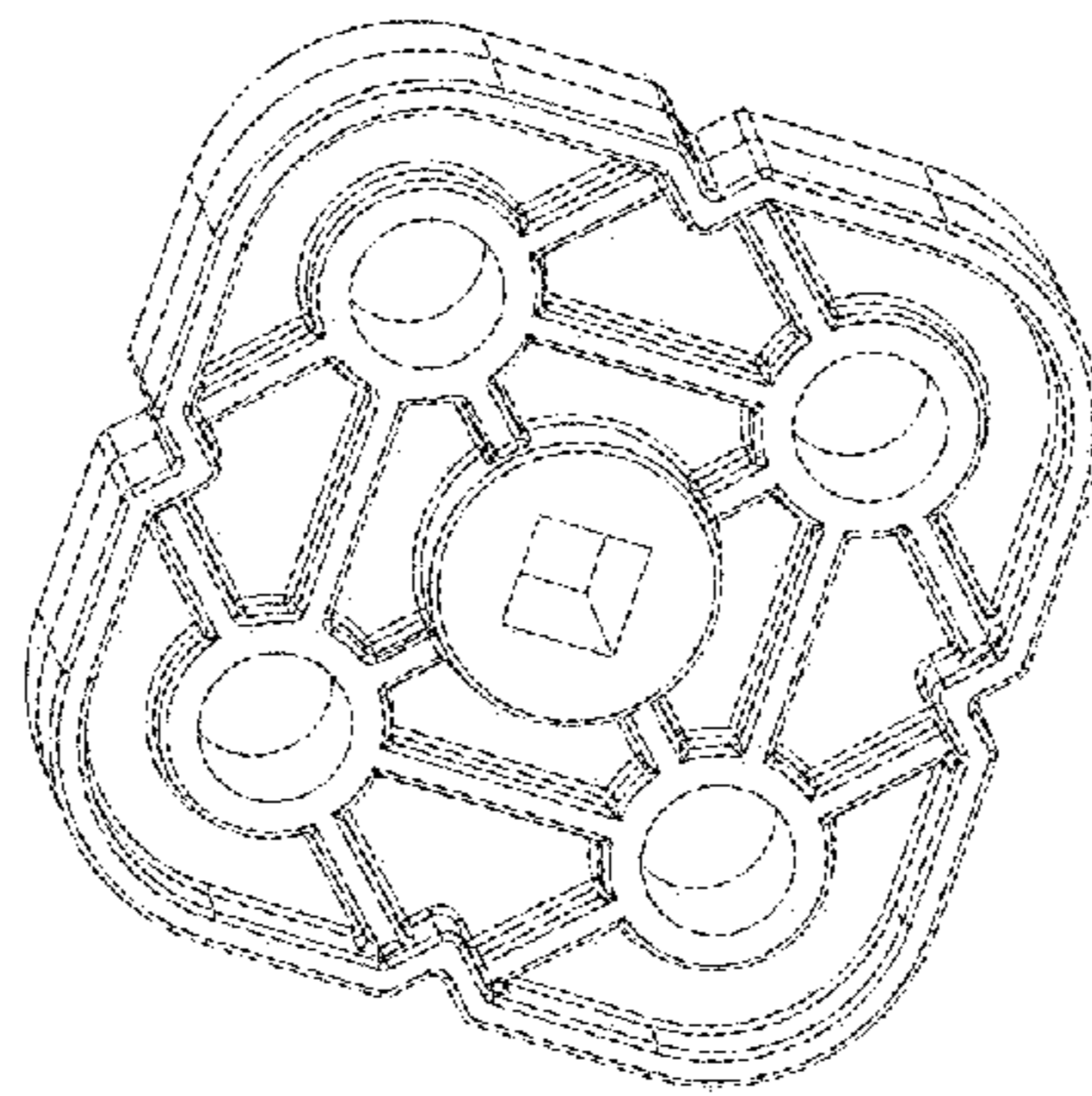

FIGURE 36

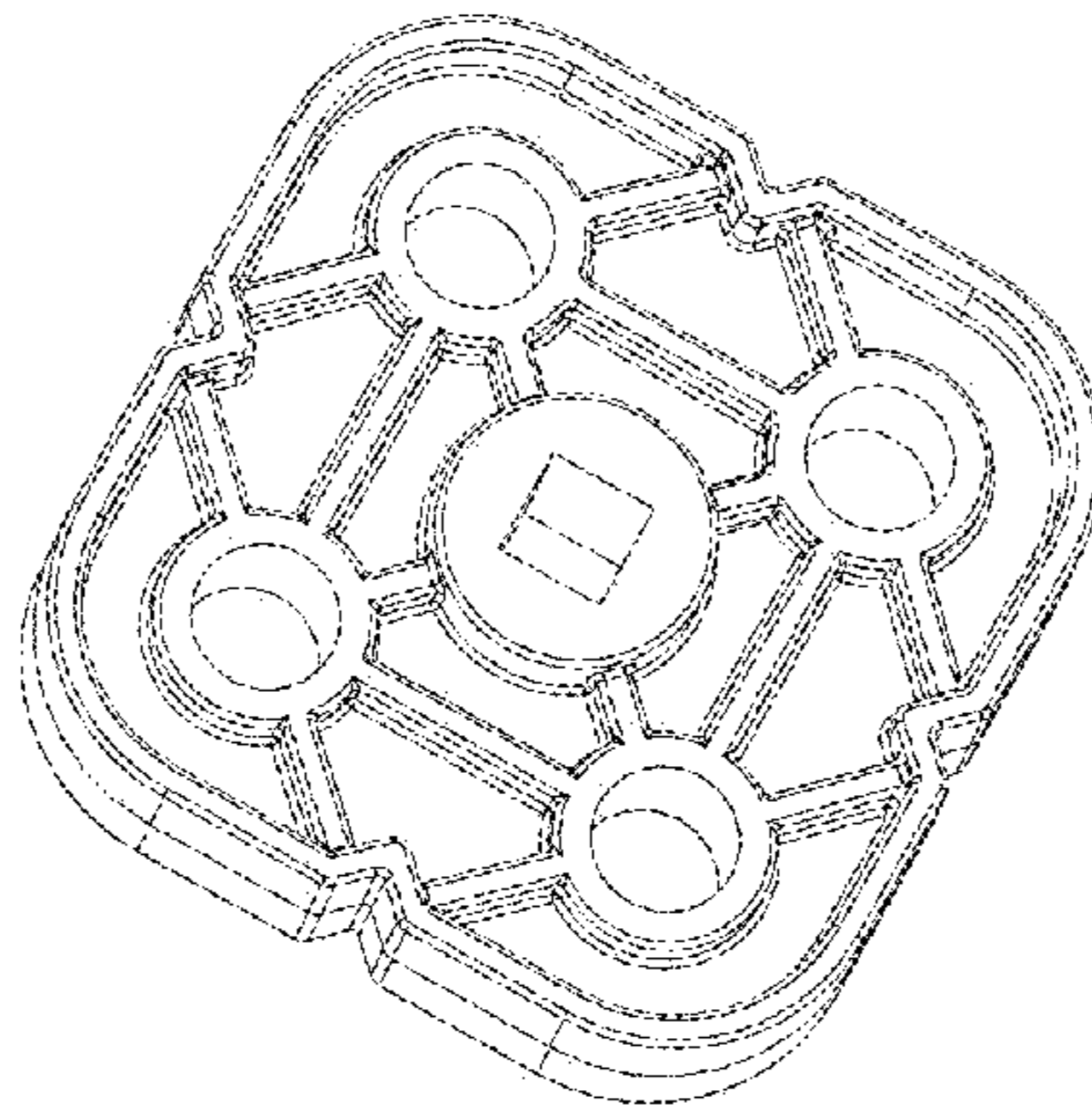

FIGURE 37

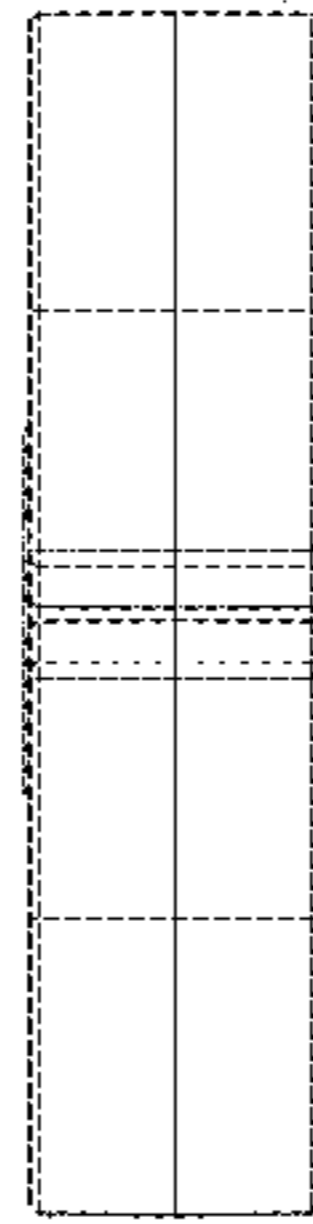

FIGURE 38

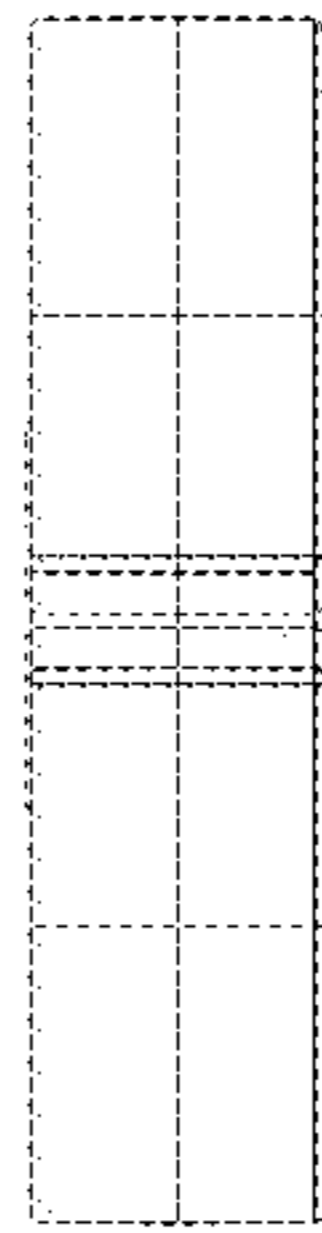



FIGURE 39

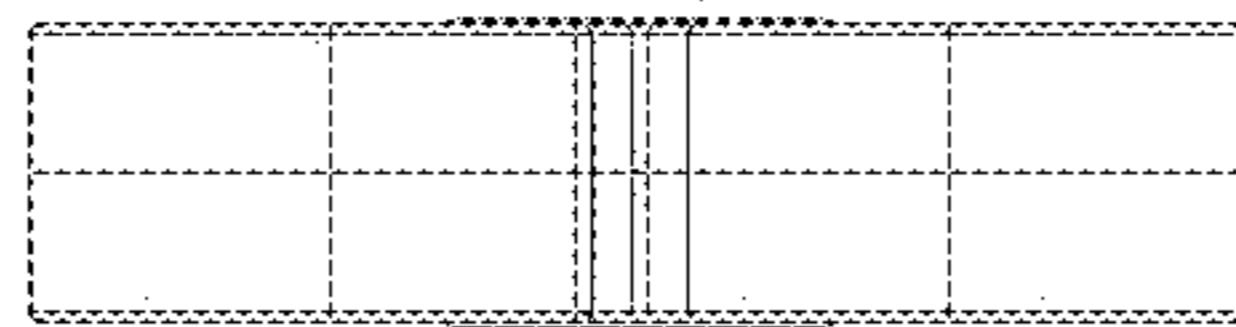

FIGURE 40

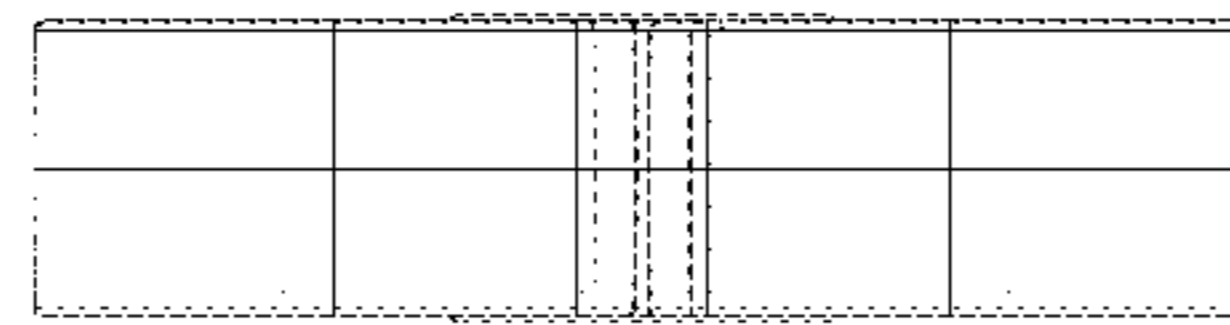

FIGURE 41

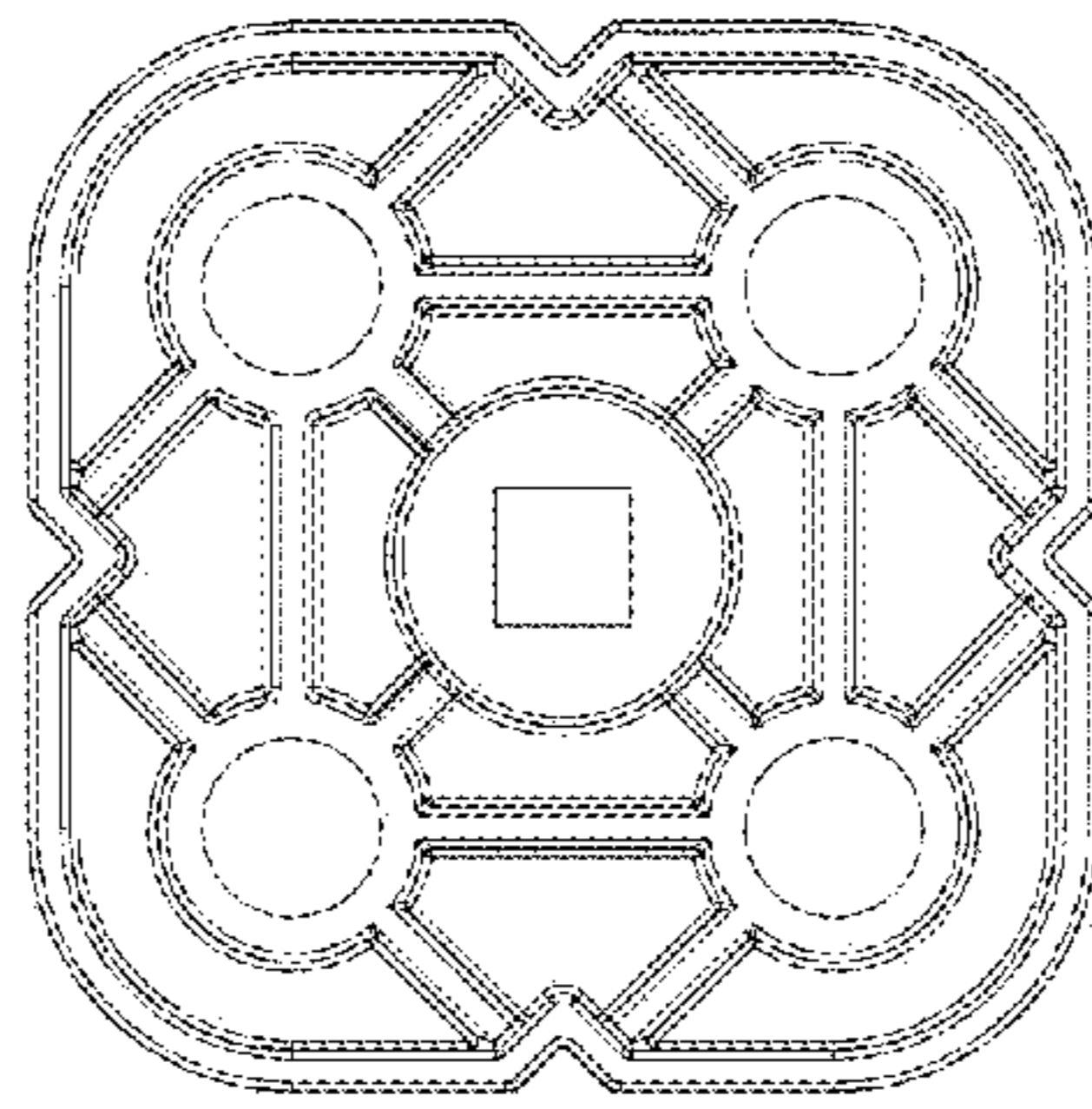

FIGURE 42

