



US00D705771S

(12) **United States Design Patent**
Kubota et al.

(10) **Patent No.:** **US D705,771 S**
(45) **Date of Patent:** **** May 27, 2014**

(54) **COMPUTER**

(75) Inventors: **Yuuki Kubota**, Tokyo (JP); **Kirio Masui**, Tokyo (JP)

(73) Assignee: **Sony Corporation**, Tokyo (JP)

(**) Term: **14 Years**

(21) Appl. No.: **29/371,992**

(22) Filed: **Apr. 9, 2012**

Related U.S. Application Data

(63) Continuation-in-part of application No. 29/371,657, filed on Jun. 27, 2011, now Pat. No. Des. 679,702.

(30) **Foreign Application Priority Data**

Dec. 27, 2010	(JP)	D2010-031180
Dec. 27, 2010	(JP)	D2010-031181
Dec. 28, 2010	(JP)	D2010-031470
Dec. 28, 2010	(JP)	D2010-031471
Dec. 28, 2010	(JP)	D2010-031472
Dec. 28, 2010	(JP)	D2010-031473
Dec. 28, 2010	(JP)	D2010-031474
Dec. 28, 2010	(JP)	D2010-031475
Dec. 28, 2010	(JP)	D2010-031476
Dec. 28, 2010	(JP)	D2010-031494

(51) **LOC (10) Cl.** **14-02**

(52) **U.S. Cl.**
USPC **D14/315**

(58) **Field of Classification Search**

USPC D14/315-328; D18/1, 2, 7, 11;
235/145 A, 145 R; 341/22, 23; 345/104,
345/156, 168, 169, 173, 87, 901-905;
361/679.08-679.18, 679.27; 400/486,
400/489

See application file for complete search history.

(56) **References Cited**

U.S. PATENT DOCUMENTS

D467,915	S	12/2002	Wada	
6,519,139	B2 *	2/2003	Kambayashi 361/679.09
D478,332	S	8/2003	Wada	
D559,245	S *	1/2008	Iseki D14/318
D559,247	S *	1/2008	Kawase D14/318
D581,410	S *	11/2008	Kumano D14/318
2005/0018396	A1 *	1/2005	Nakajima et al. 361/683
2005/0041378	A1 *	2/2005	Hamada et al. 361/680

* cited by examiner

Primary Examiner — Freda S Nunn

(74) *Attorney, Agent, or Firm* — Rader, Fishman & Grauer PLLC

(57) **CLAIM**

The ornamental design for a computer, as shown and described.

DESCRIPTION

FIG. 1 is a rear, top, right perspective view of a first embodiment of a computer showing our new design;
 FIG. 2 is a rear elevational view thereof;
 FIG. 3 is a left side elevational view thereof;
 FIG. 4 is a right side elevational view thereof;
 FIG. 5 is a top plan view thereof; and
 FIG. 6 is a bottom plan view thereof.
 FIG. 7 is a front, top, right perspective view of the embodiment of FIG. 1 wherein the screen portion is in a closed position;
 FIG. 8 is a rear, top, right perspective view thereof;
 FIG. 9 is a rear elevational view thereof;
 FIG. 10 is a right side elevational view thereof;
 FIG. 11 is a top plan view thereof; and
 FIG. 12 is a bottom plan view thereof.
 FIG. 13 is an enlarged right side elevational view thereof at the hinge portion.
 FIG. 14 is a rear elevational view of a second embodiment of a computer showing our new design;
 FIG. 15 is a left side elevational view thereof;
 FIG. 16 is a right side elevational view thereof; and

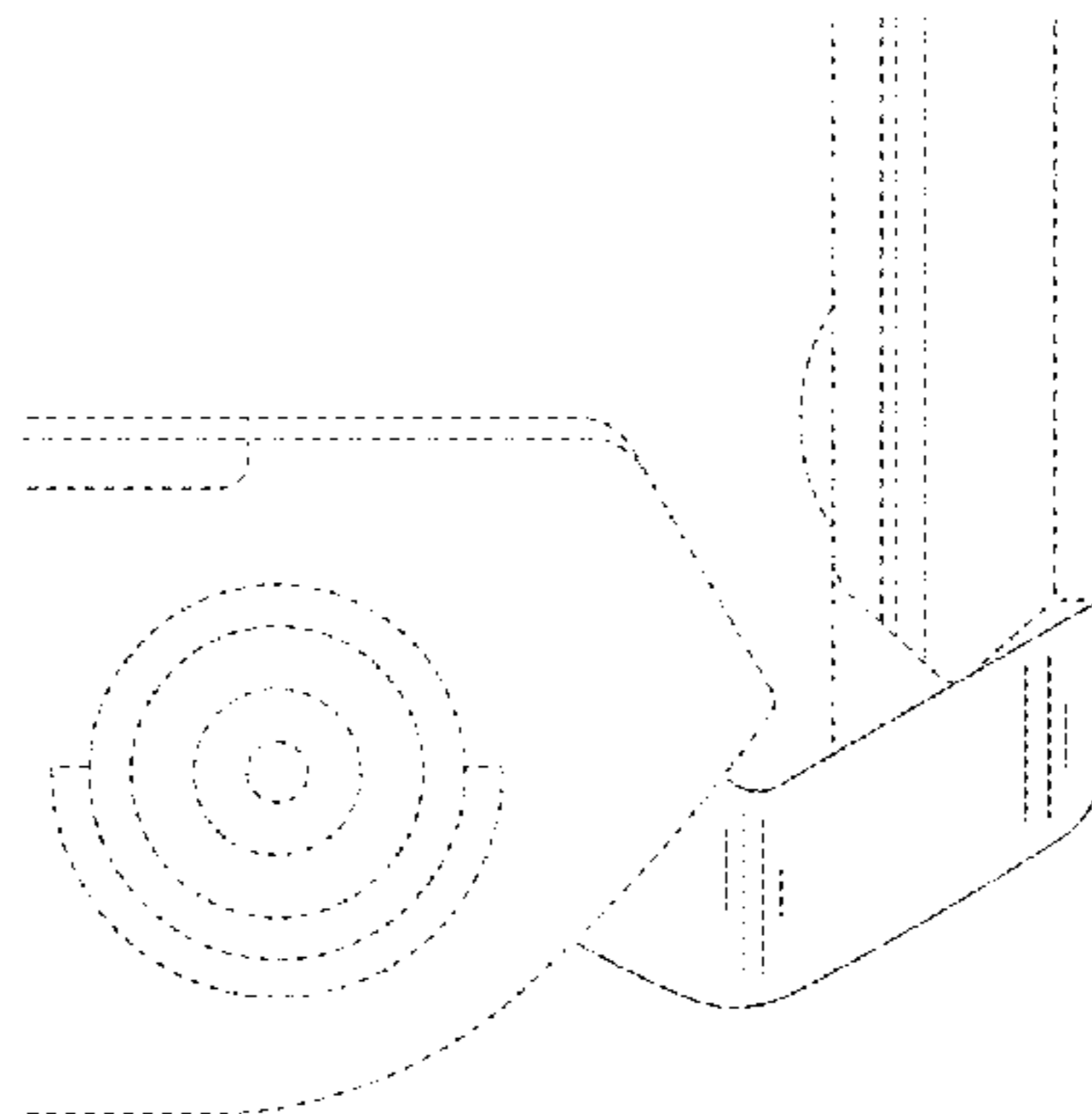

FIG. 17 is a bottom plan view thereof.

FIG. 18 is a rear, top, right perspective view of the embodiment of FIG. 14 wherein the screen portion is in a closed position;

FIG. 19 is a rear elevational view thereof;

FIG. 20 is a left side elevational view thereof;

FIG. 21 is a right side elevational view thereof;

FIG. 22 is a top plan view thereof; and

FIG. 23 is a bottom plan view thereof.

FIG. 24 is an enlarged right side elevational view thereof at the hinge portion.

FIG. 25 is a left side elevational view of a third embodiment of a computer showing our new design;

FIG. 26 is a right side elevational view thereof; and

FIG. 27 is a bottom plan view thereof.

FIG. 28 is a rear, top, right perspective view of the embodiment of FIG. 25 wherein the screen portion is in a closed position;

FIG. 29 is a rear elevational view thereof;

FIG. 30 is a left side elevational view thereof;

FIG. 31 is a right side elevational view thereof;

FIG. 32 is a top plan view thereof; and

FIG. 33 is a bottom plan view thereof; and,

FIG. 34 is an enlarged right side elevational view thereof at the hinge portion.

Portions in broken lines are for illustrative purposes only and form no part of the claimed design. Single dot-dash lines define the boundaries of, but not included in, the claimed design.

1 Claim, 31 Drawing Sheets

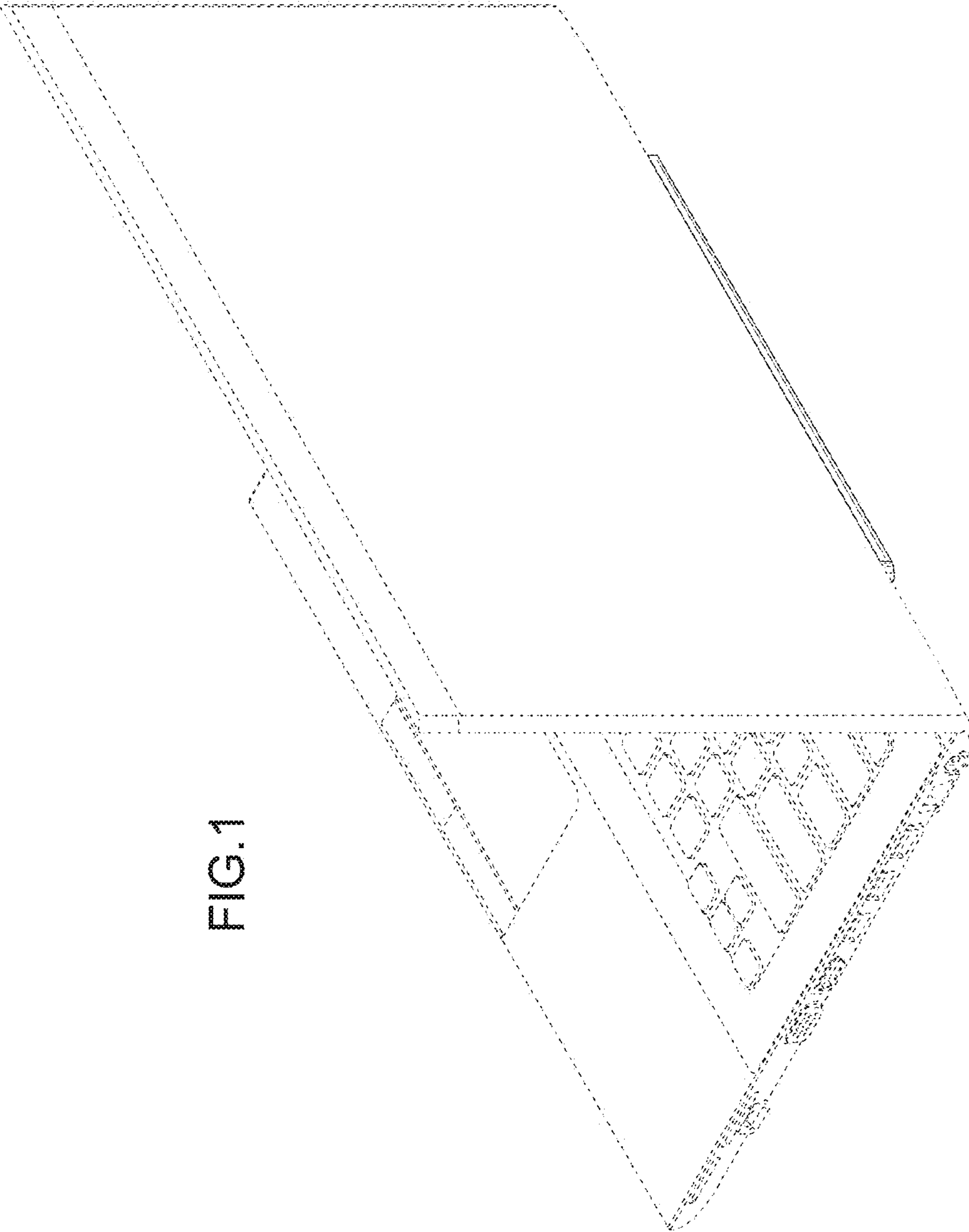

FIG.1

FIG.2

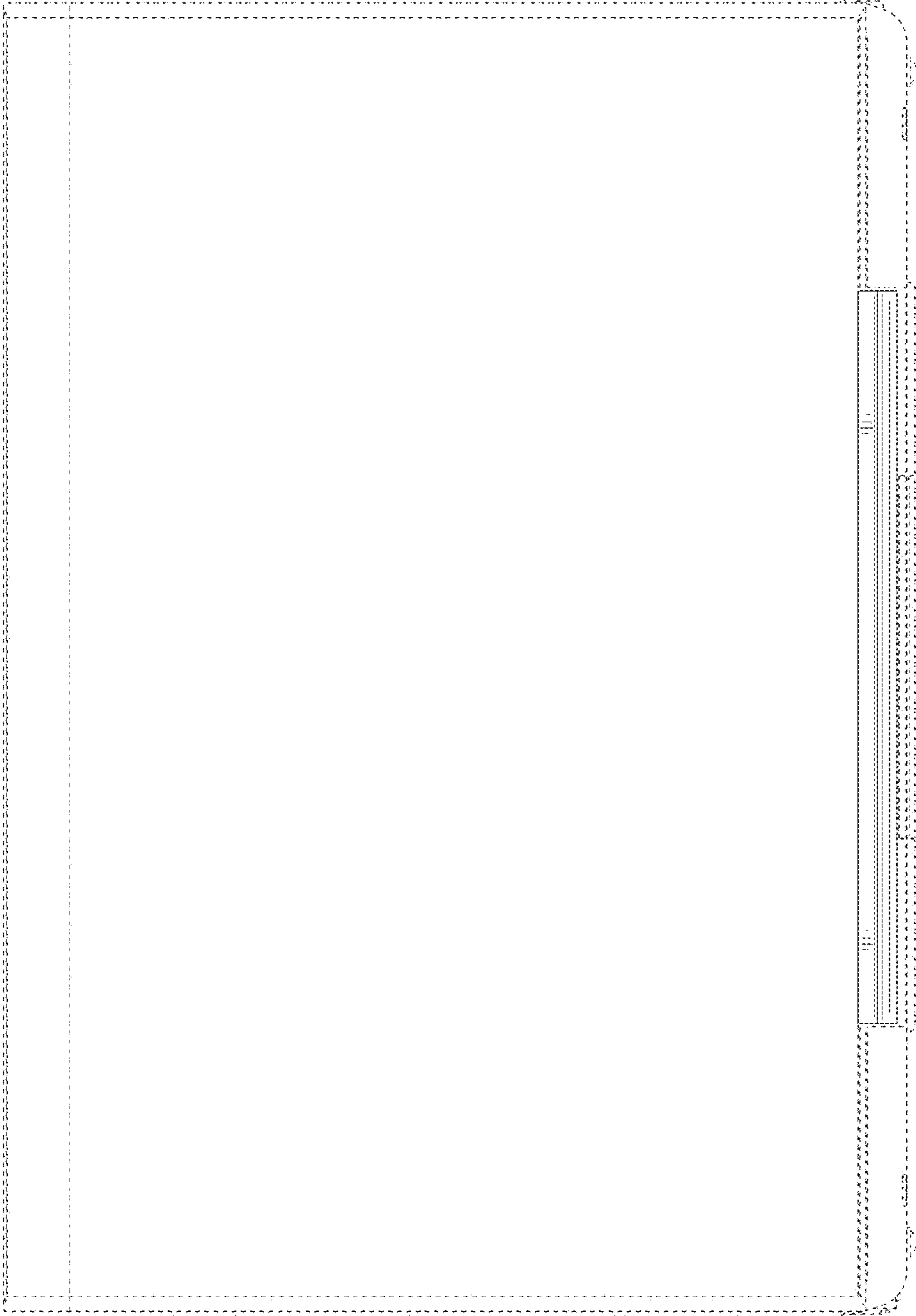

FIG. 3

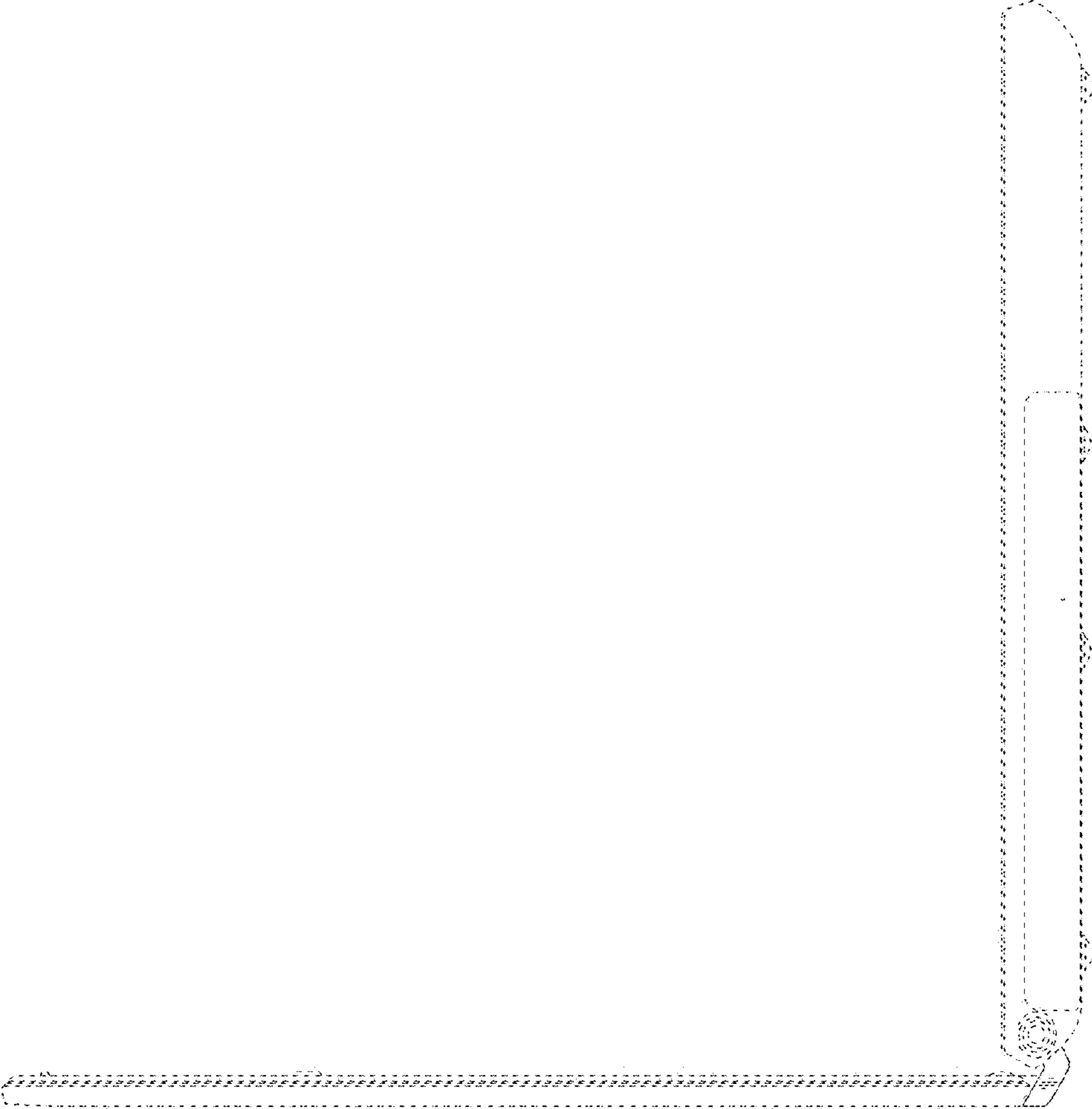

FIG. 4

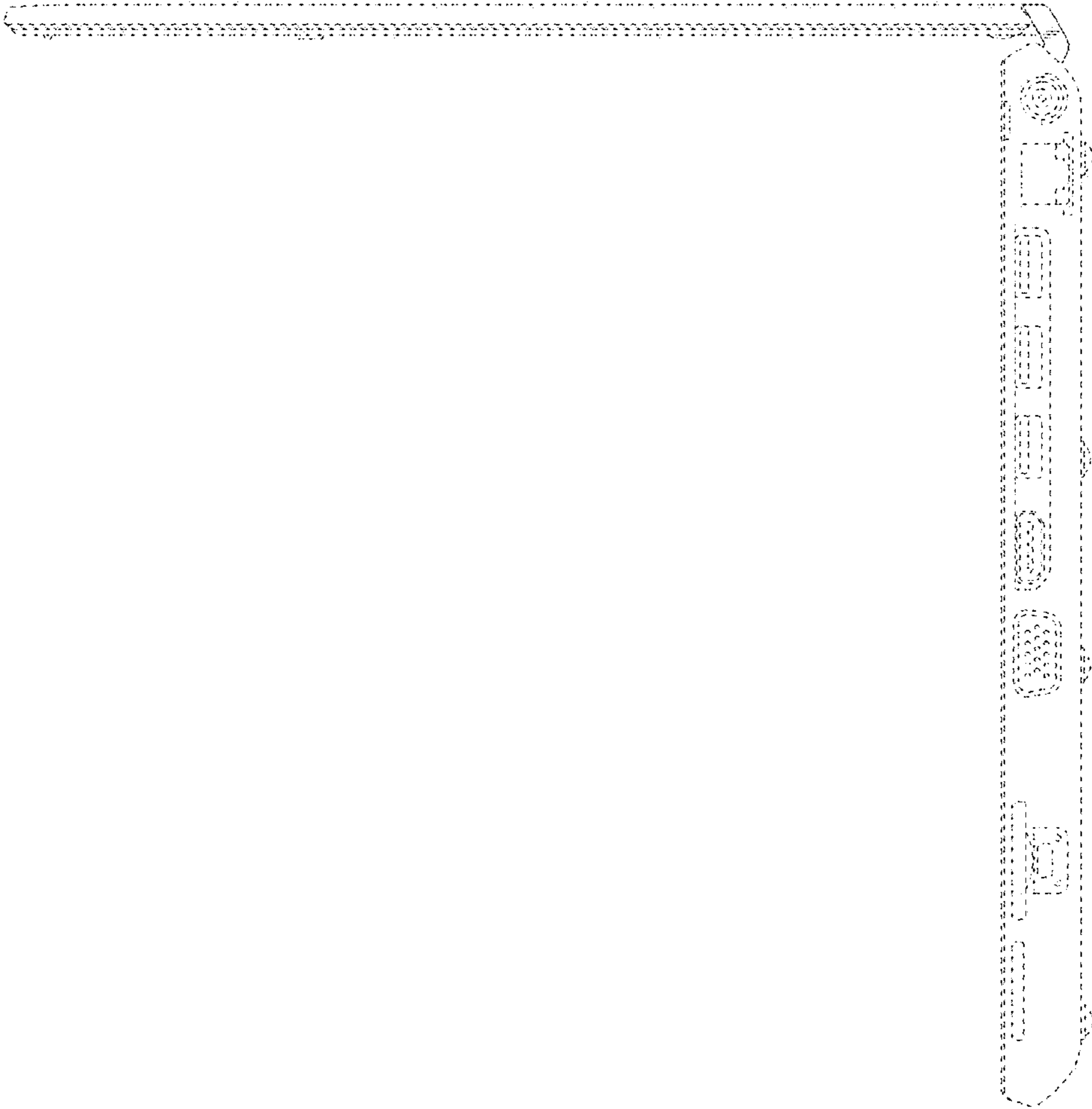

FIG. 5

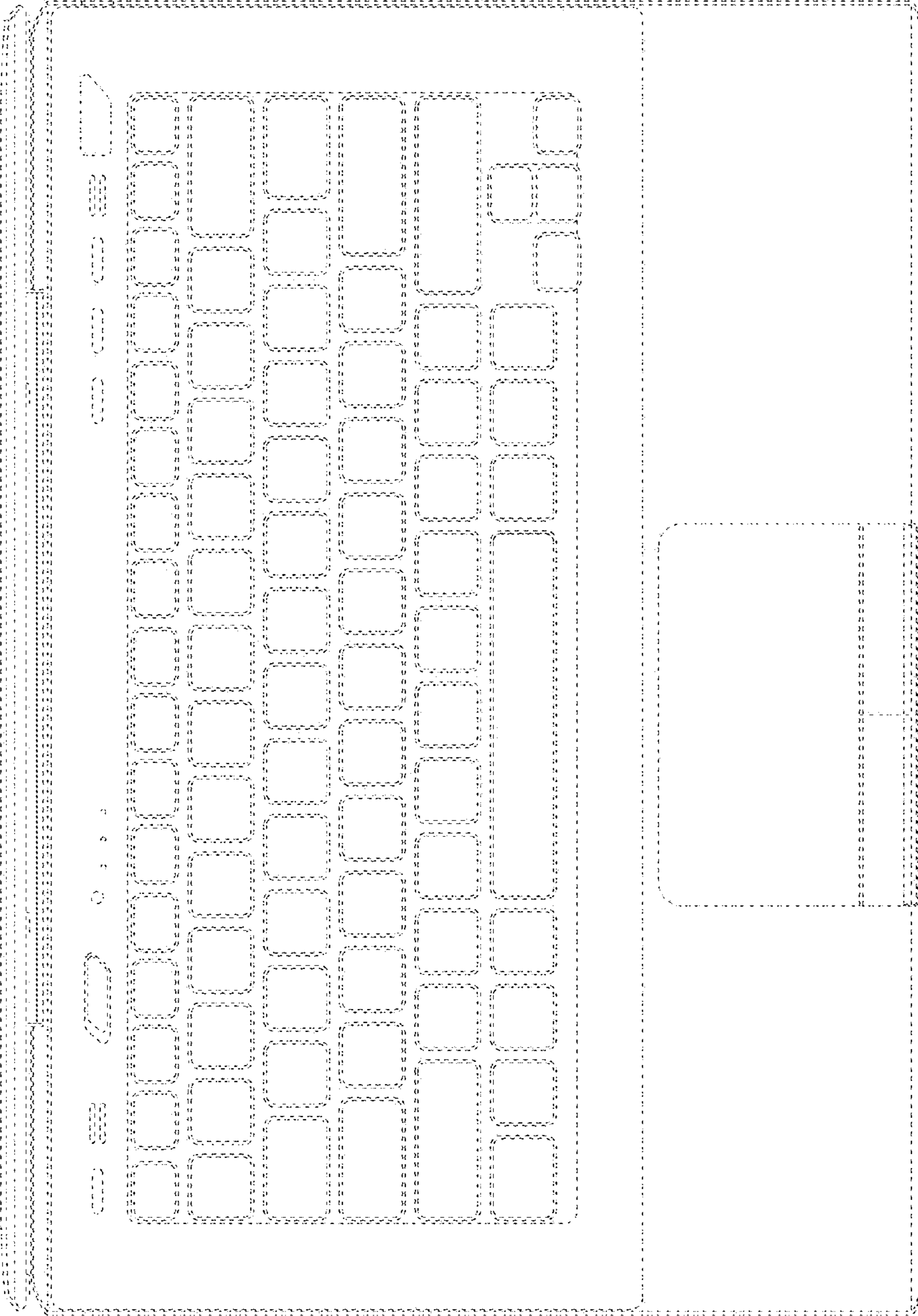
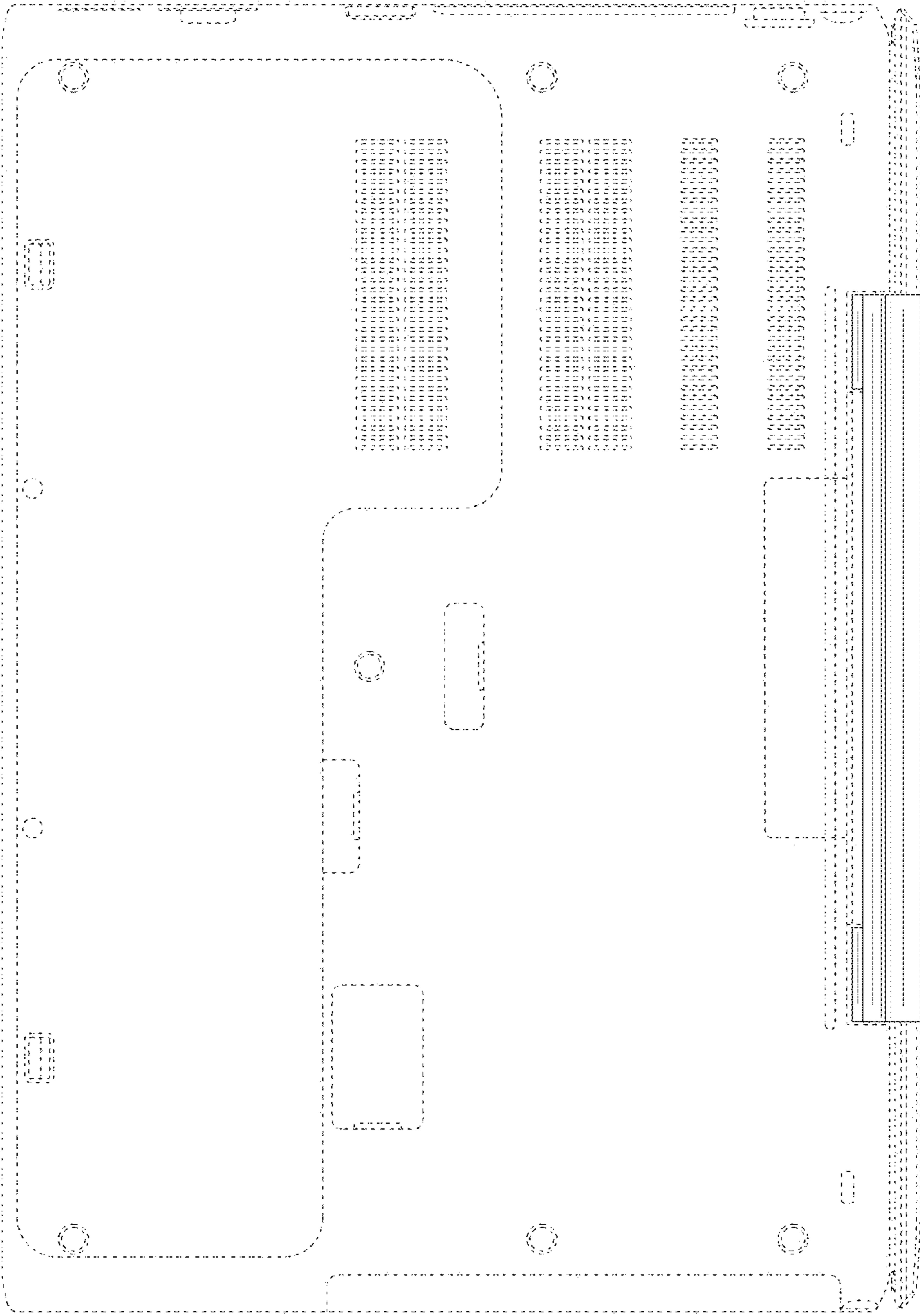

FIG.6



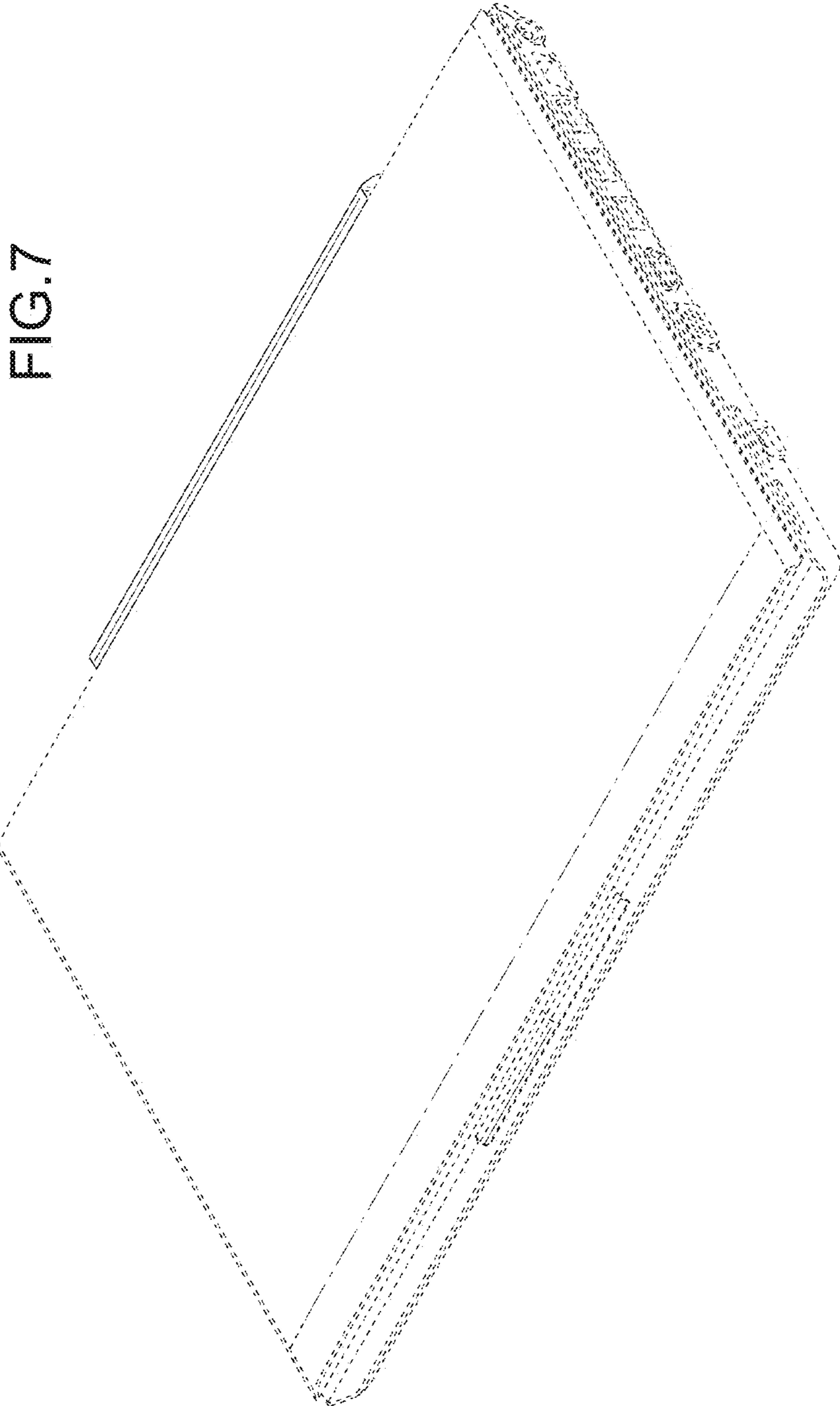

FIG. 7

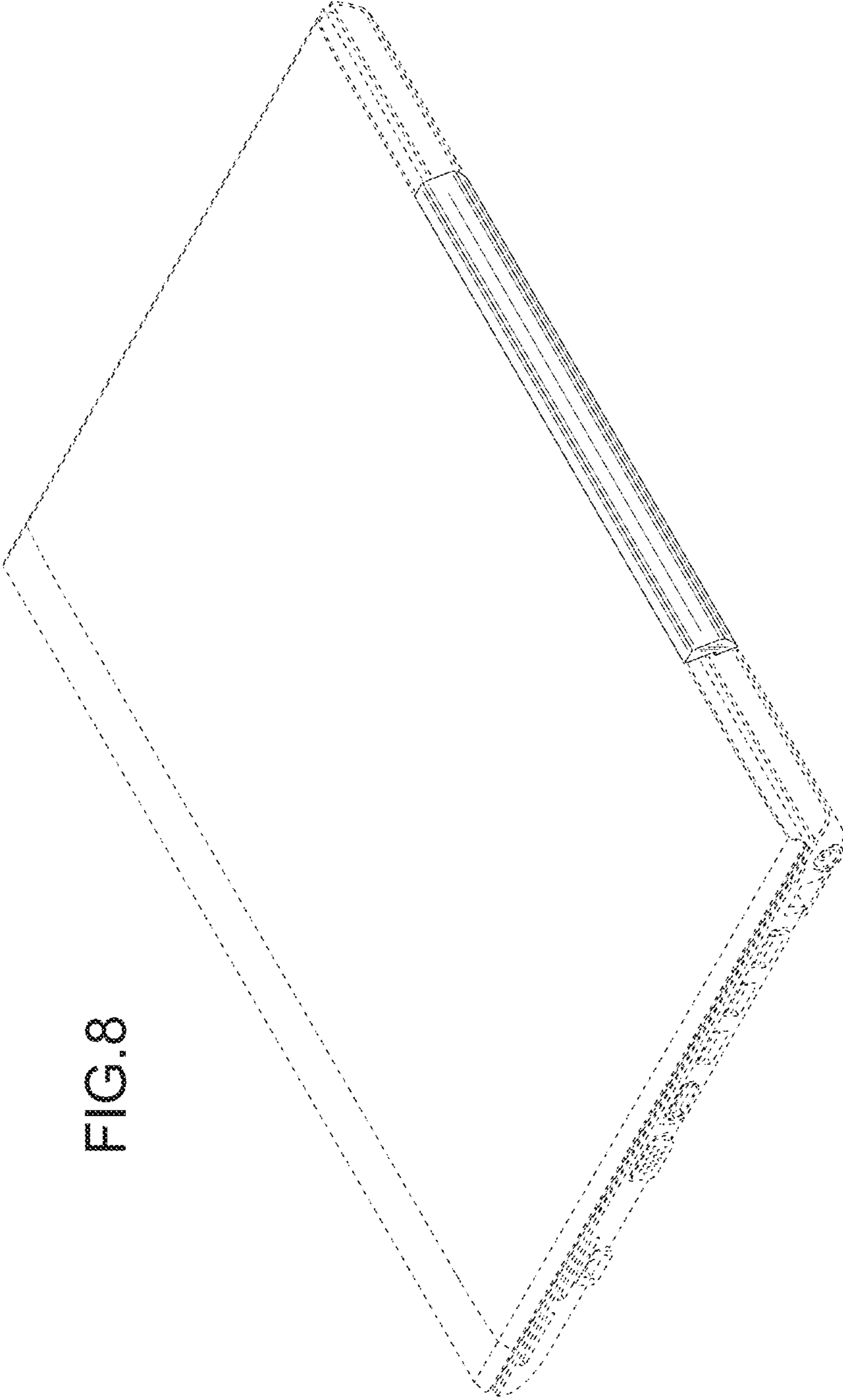

FIG.8

FIG.9

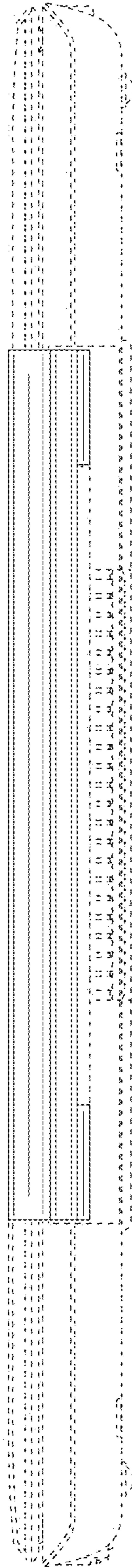

FIG.10

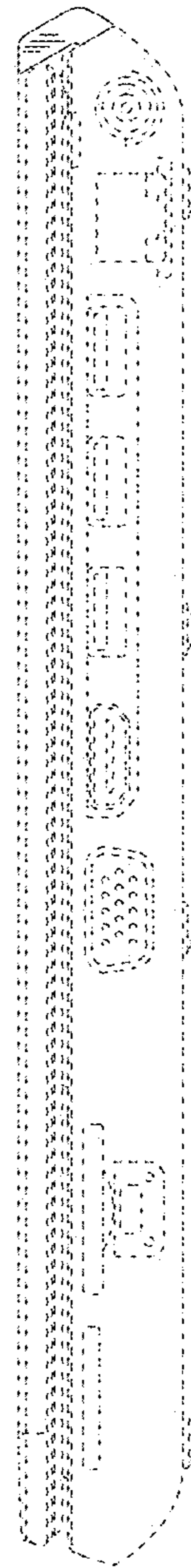

FIG.11

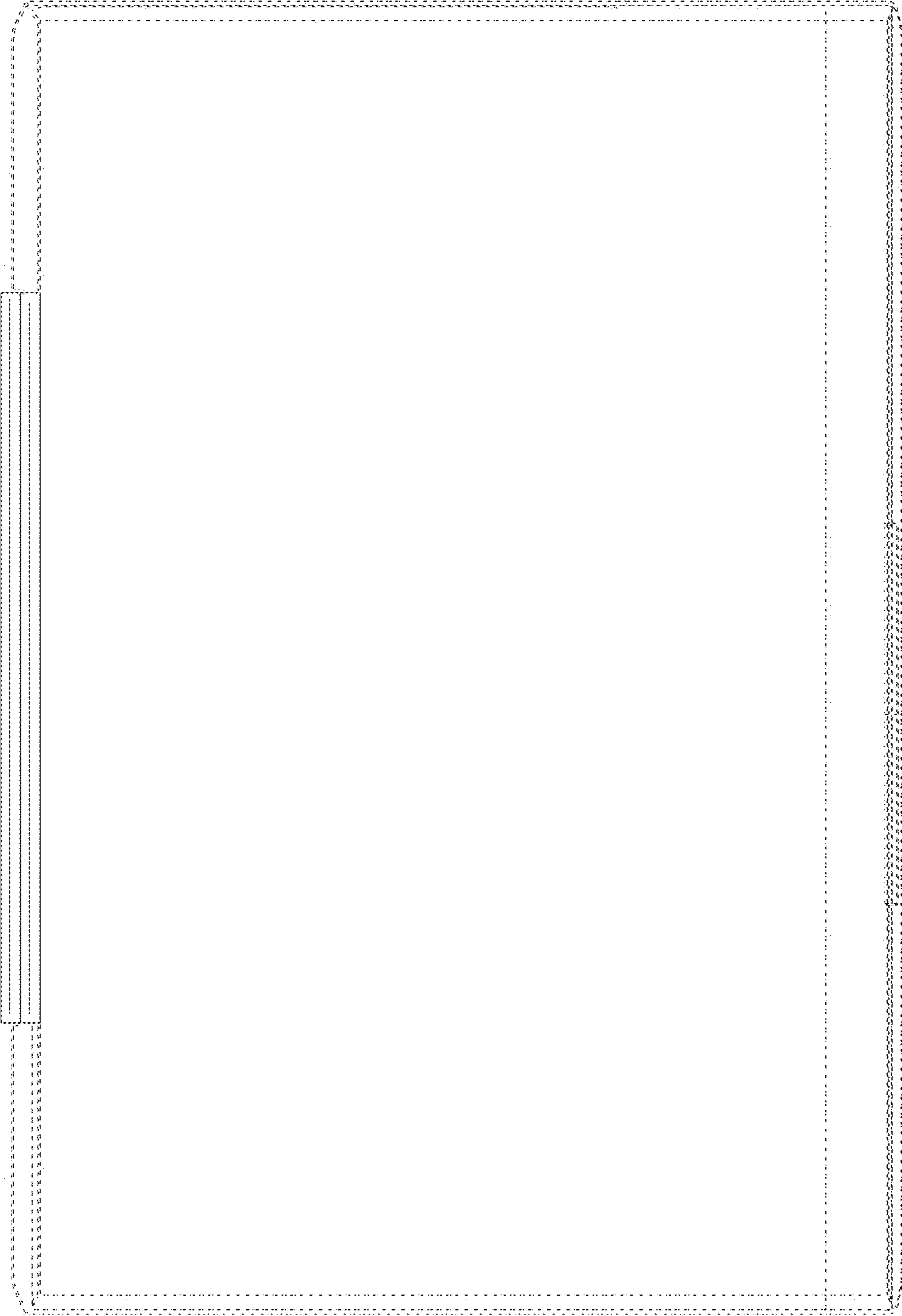

FIG.12

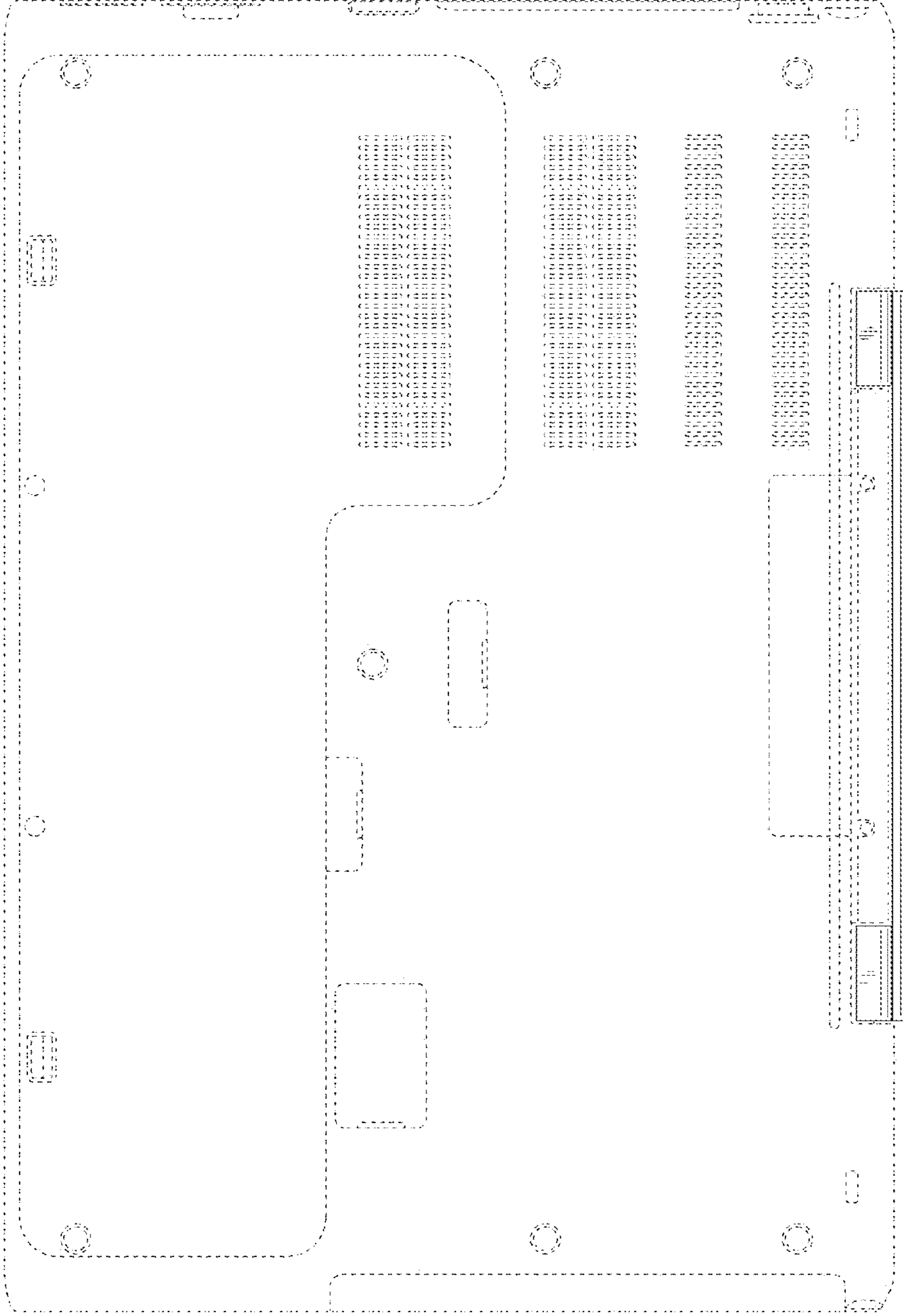

FIG. 13

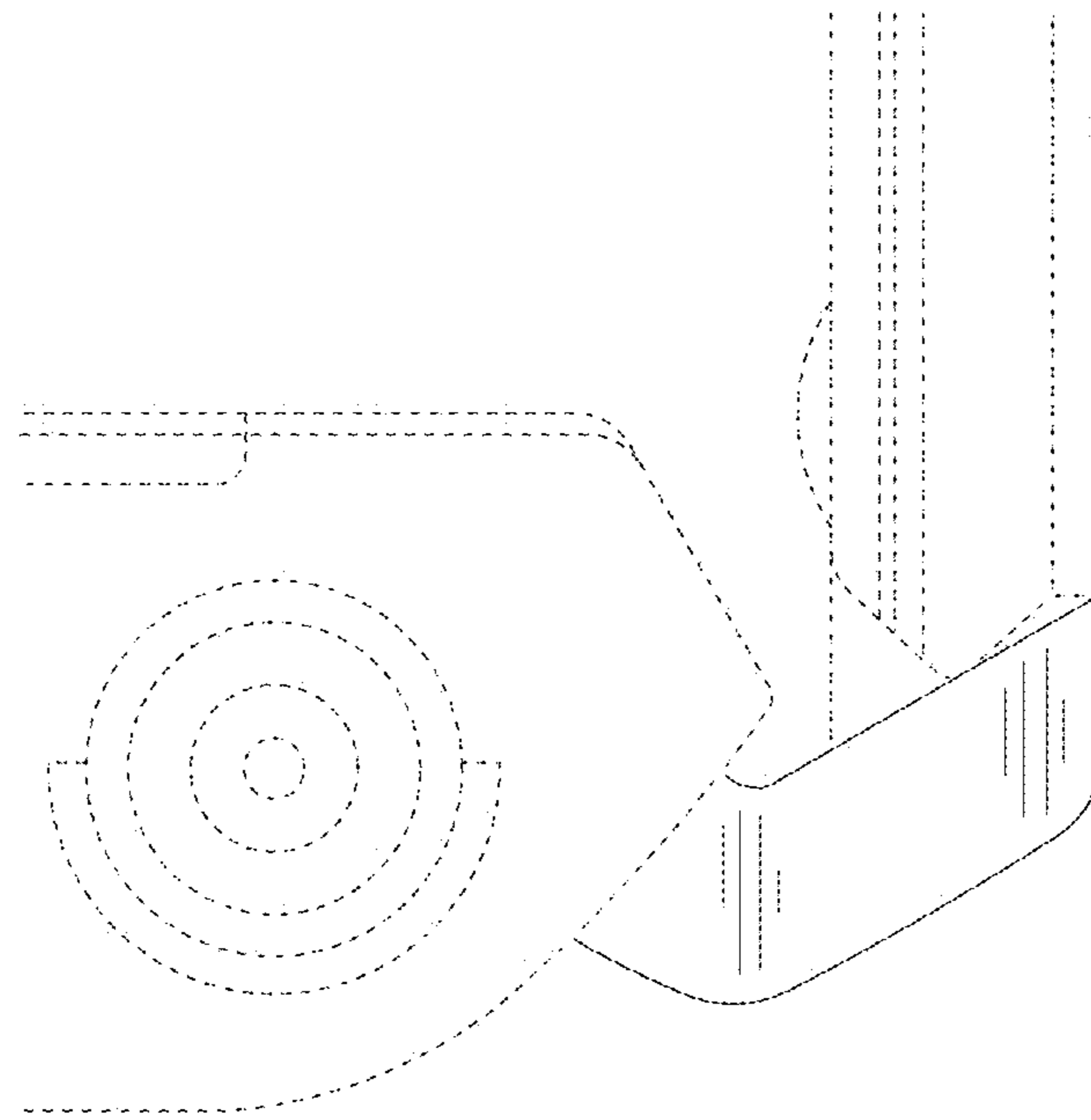

FIG. 14

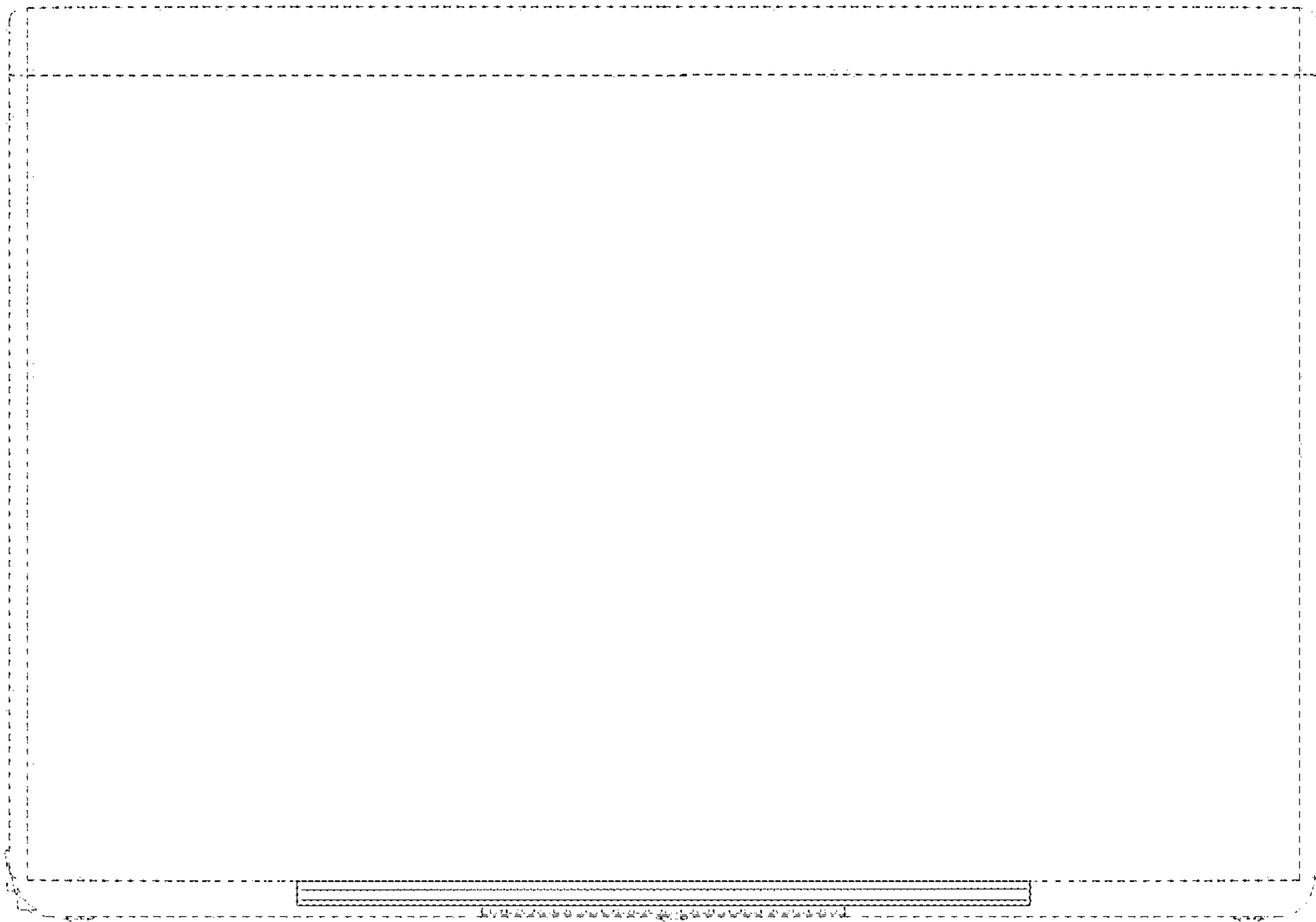

FIG. 15

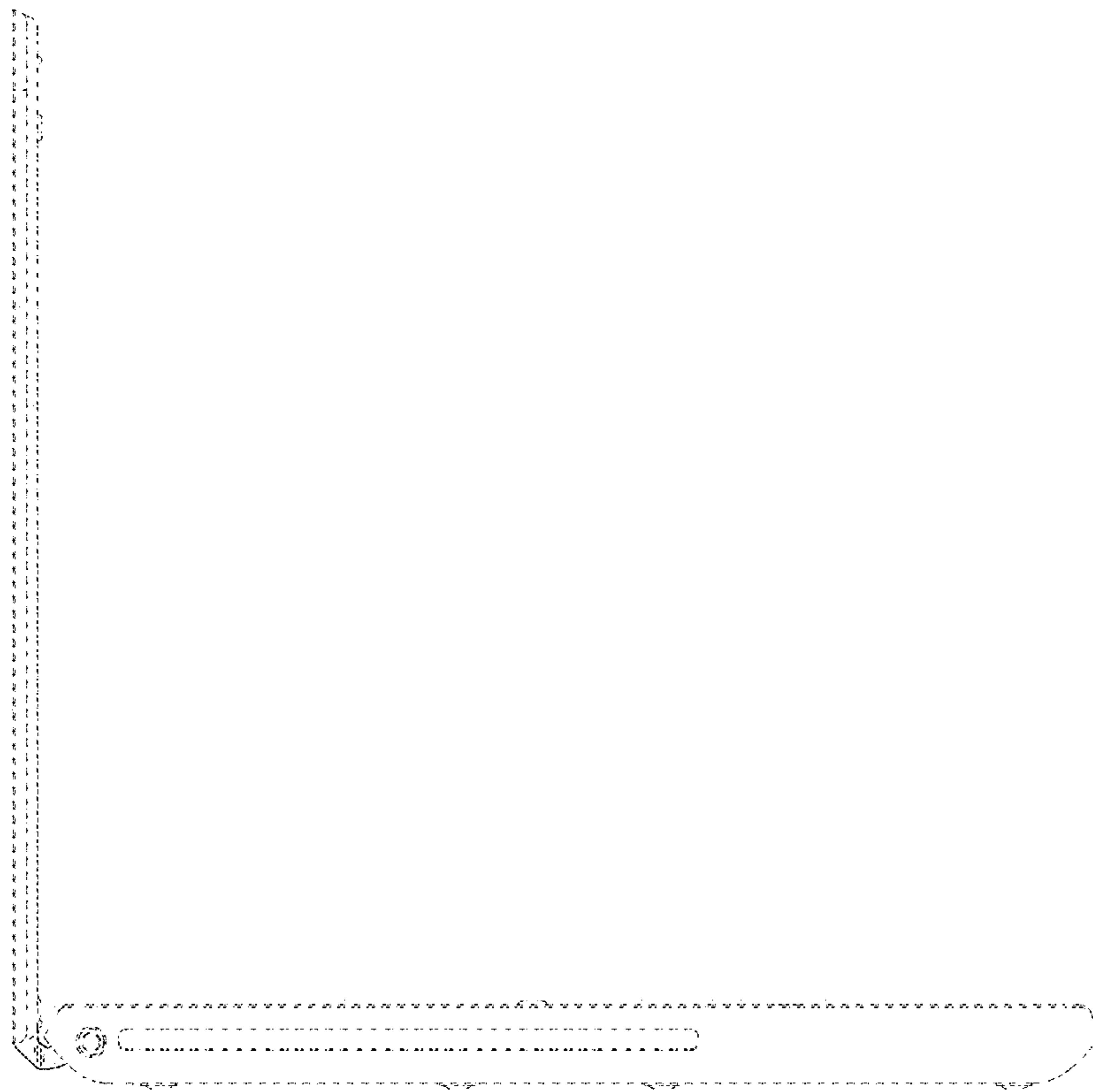

FIG. 16

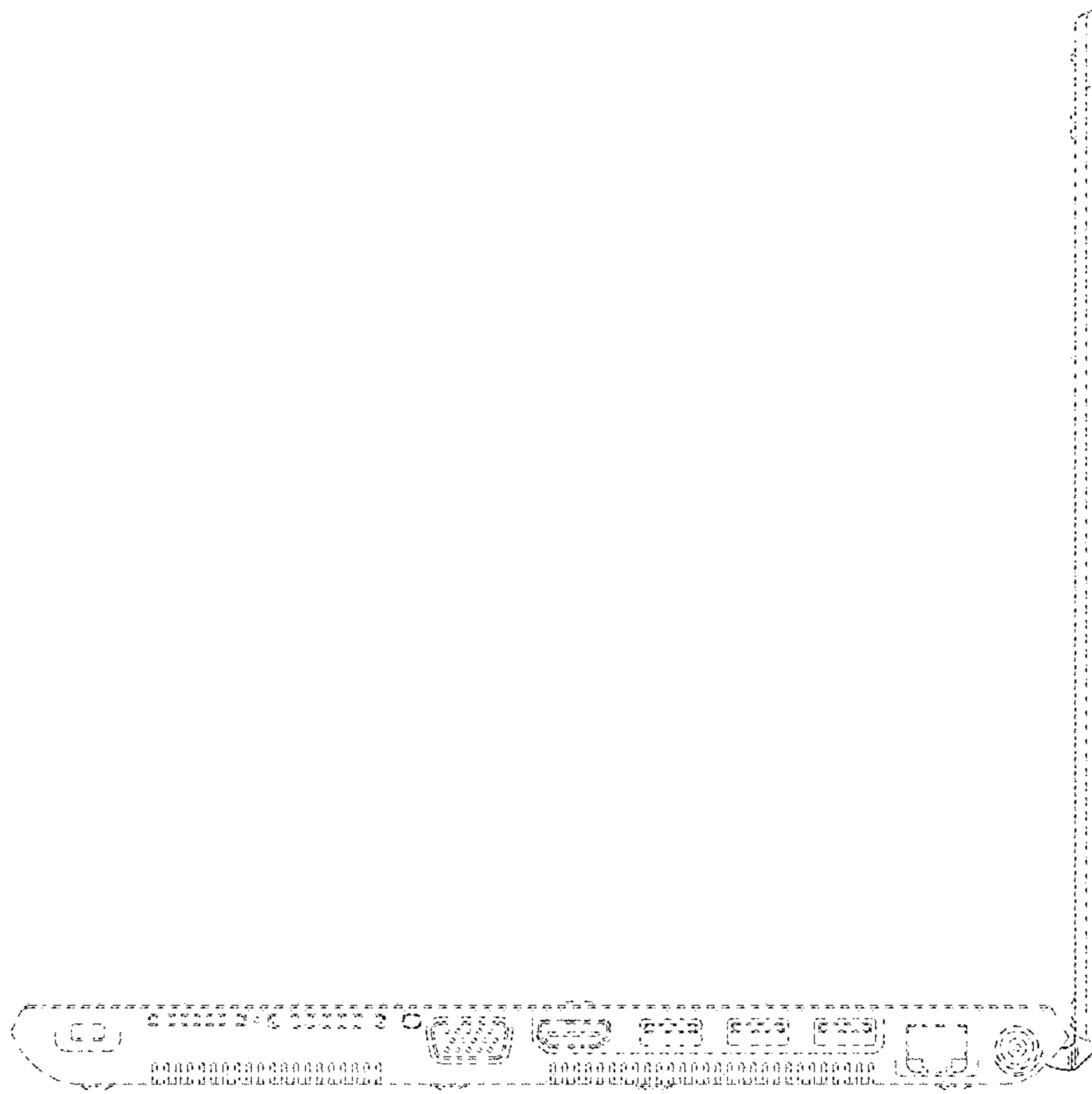
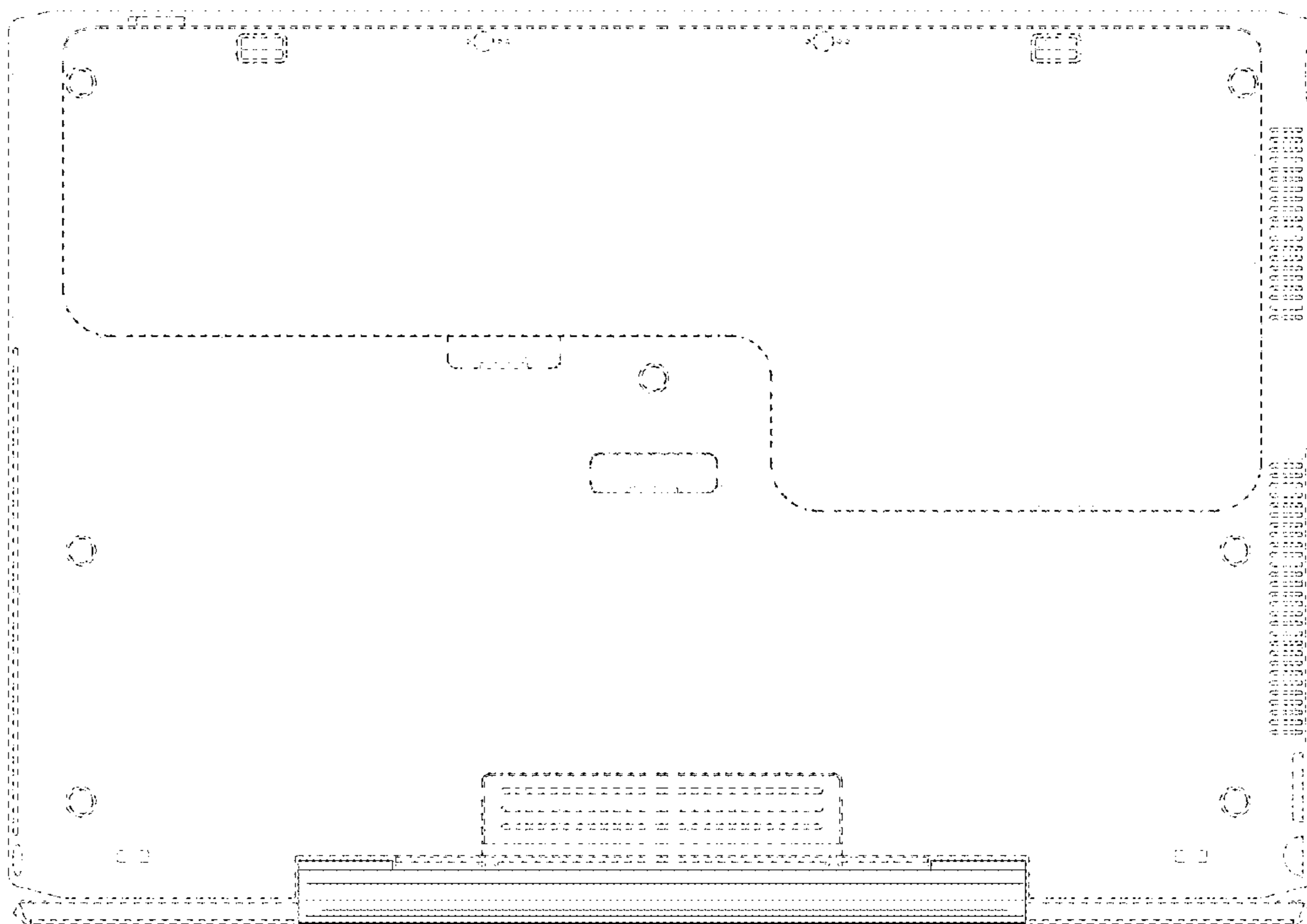

FIG. 17



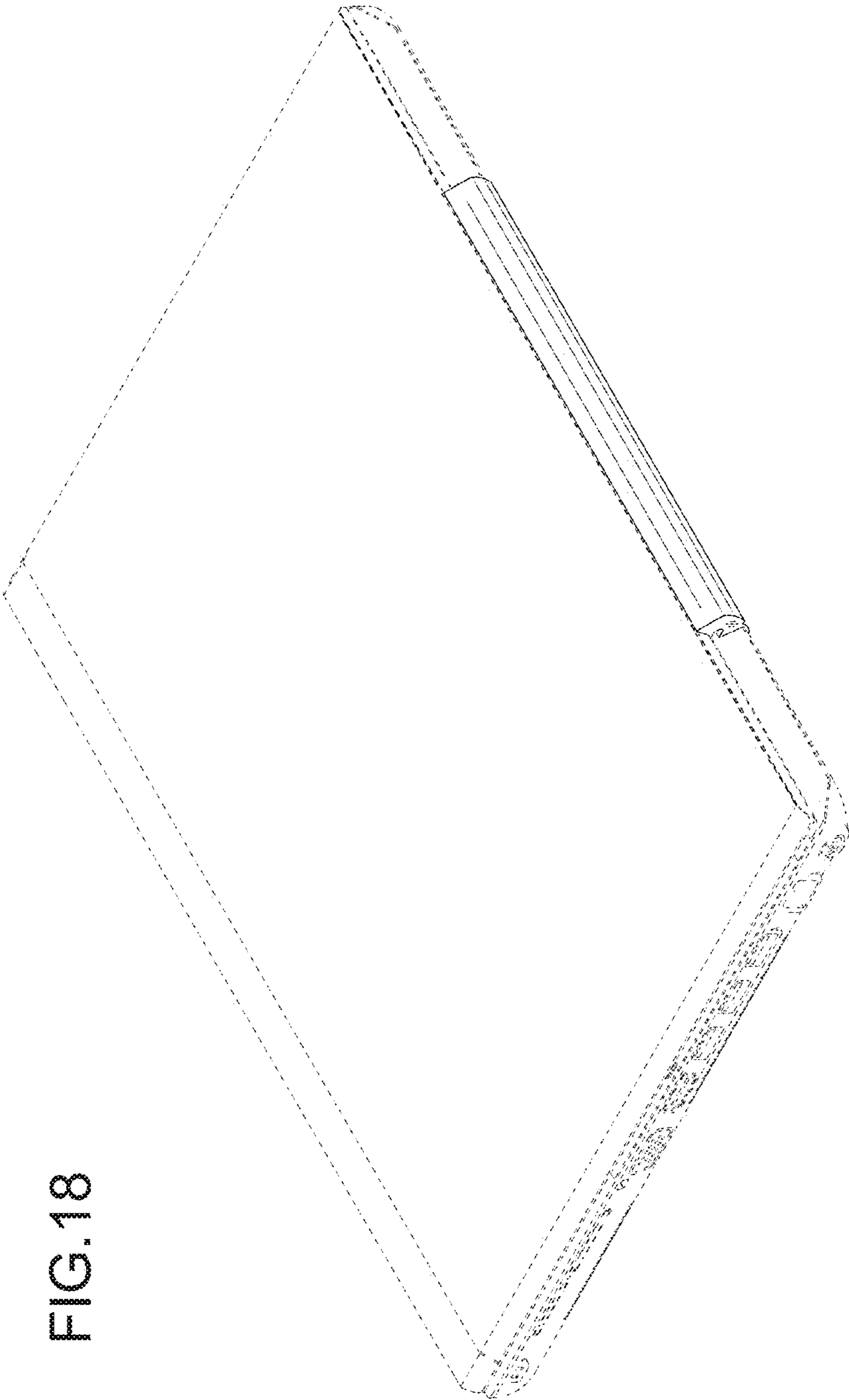

FIG.18

FIG.19

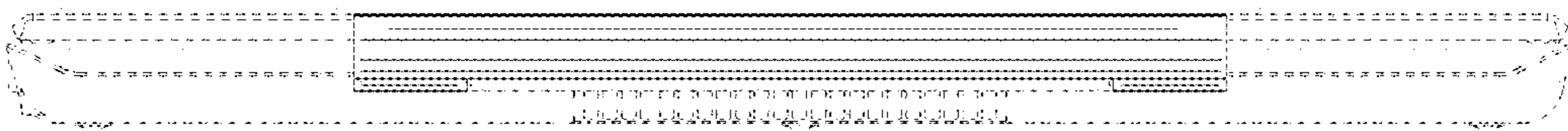

FIG.20

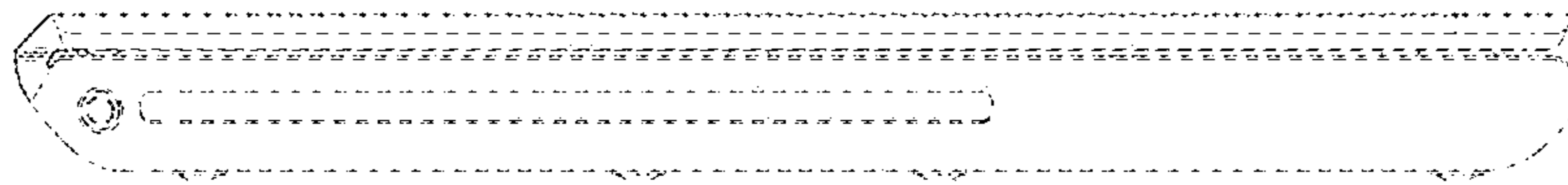

FIG.21

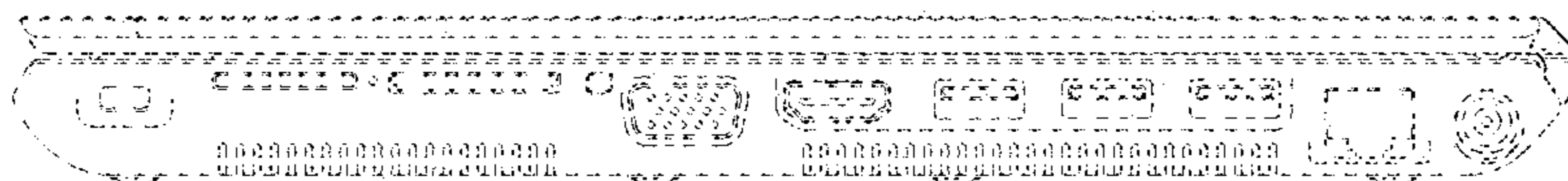

FIG.22

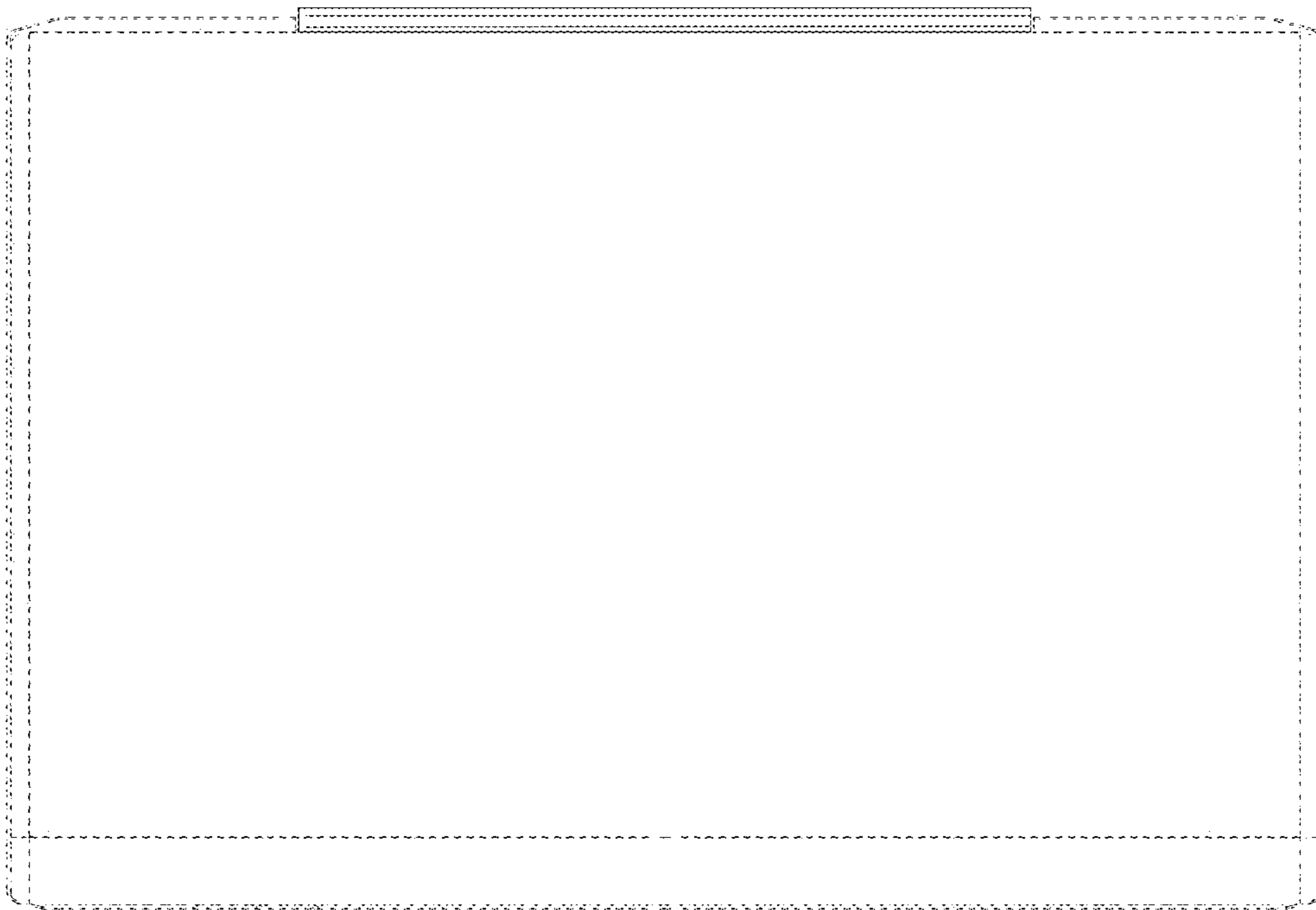

FIG.23

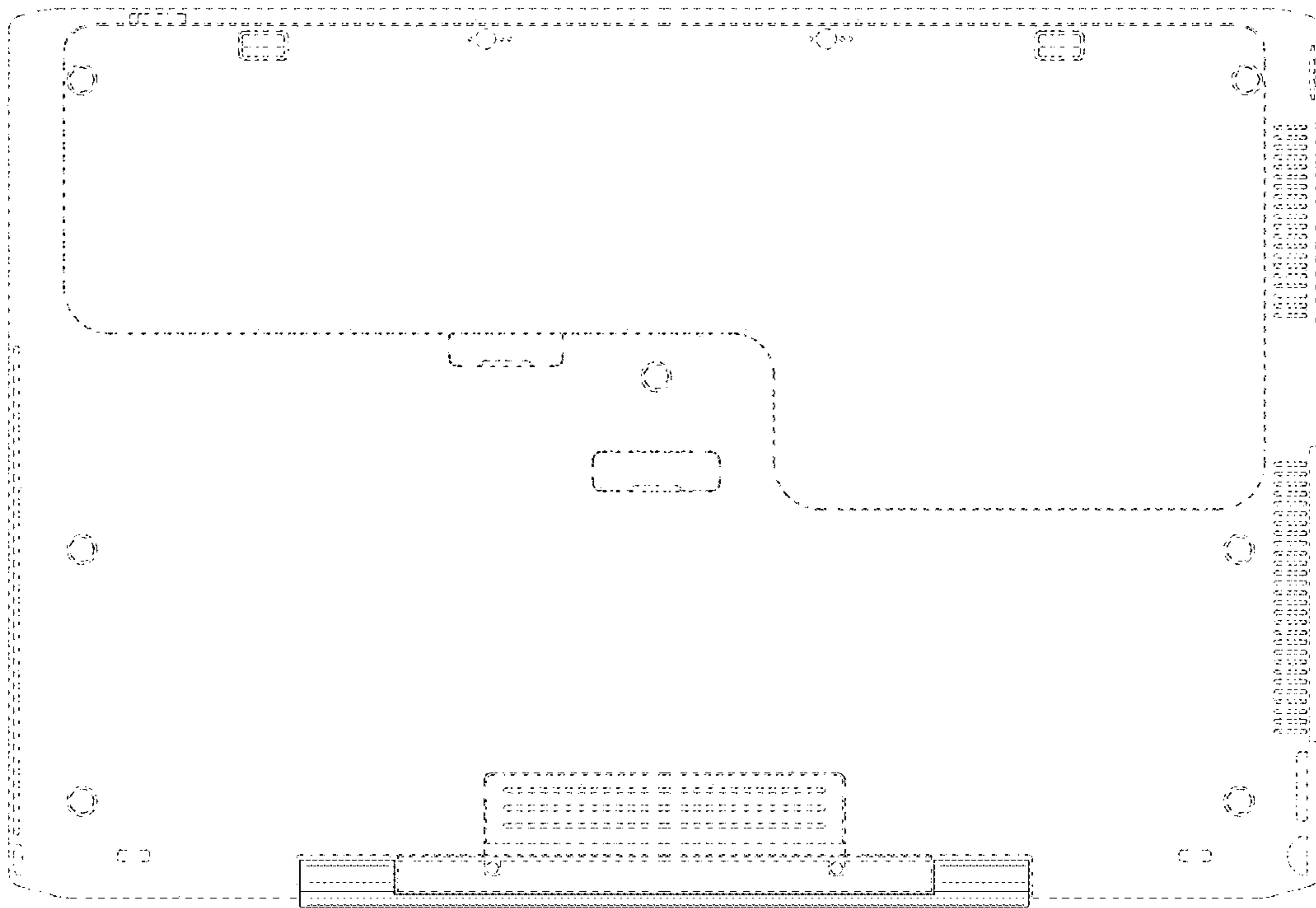

FIG.24

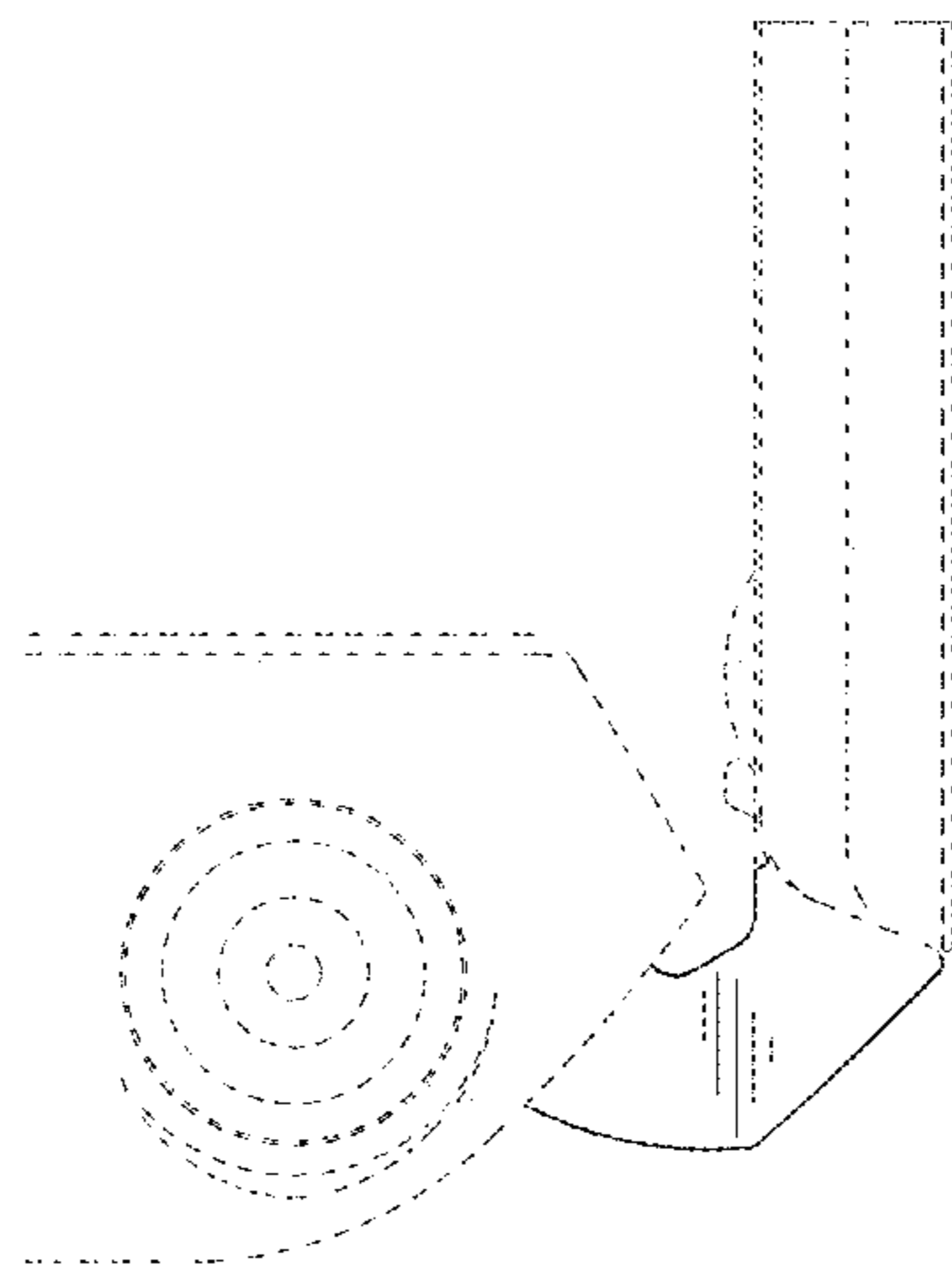

FIG.25

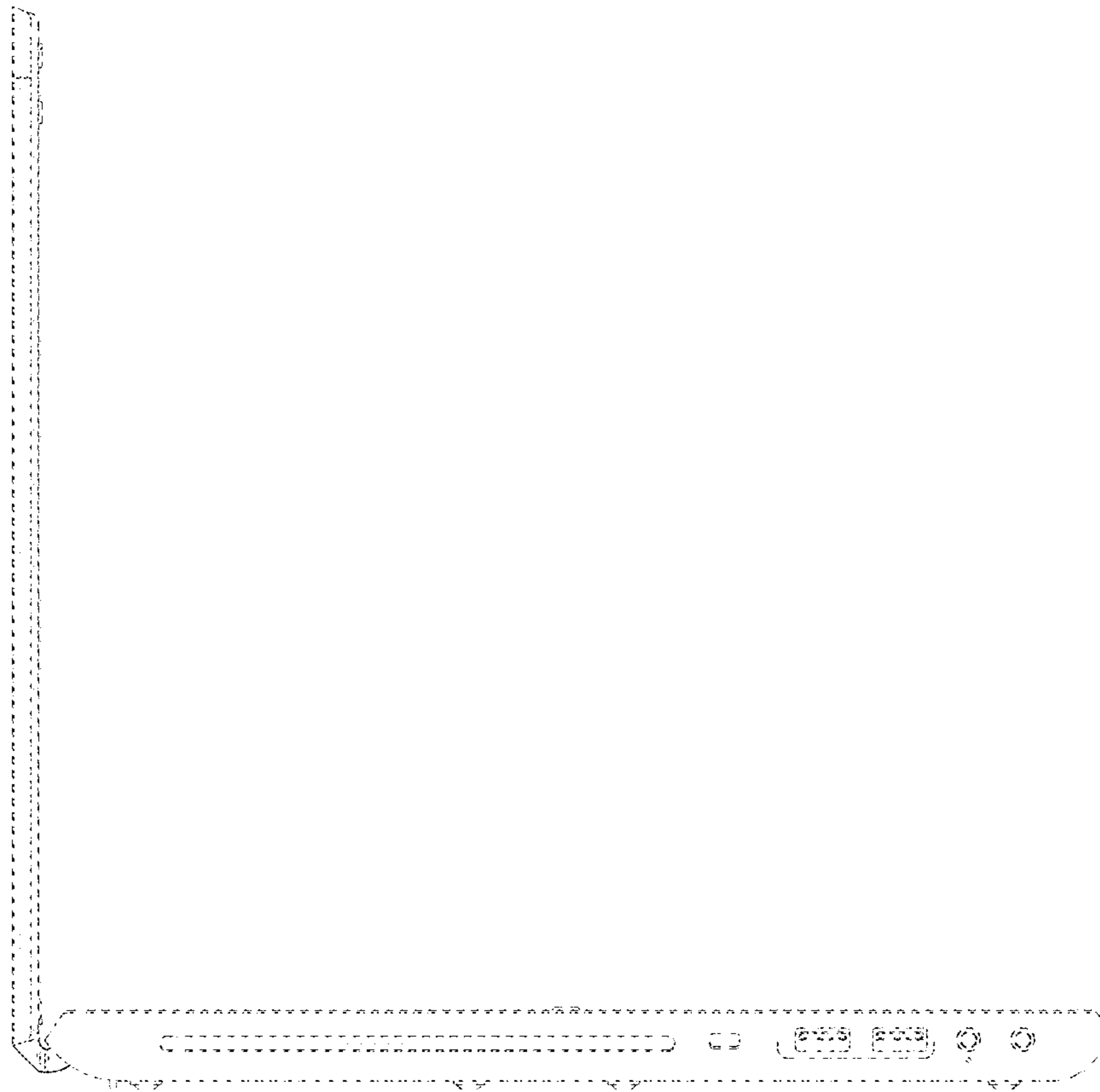

FIG.26

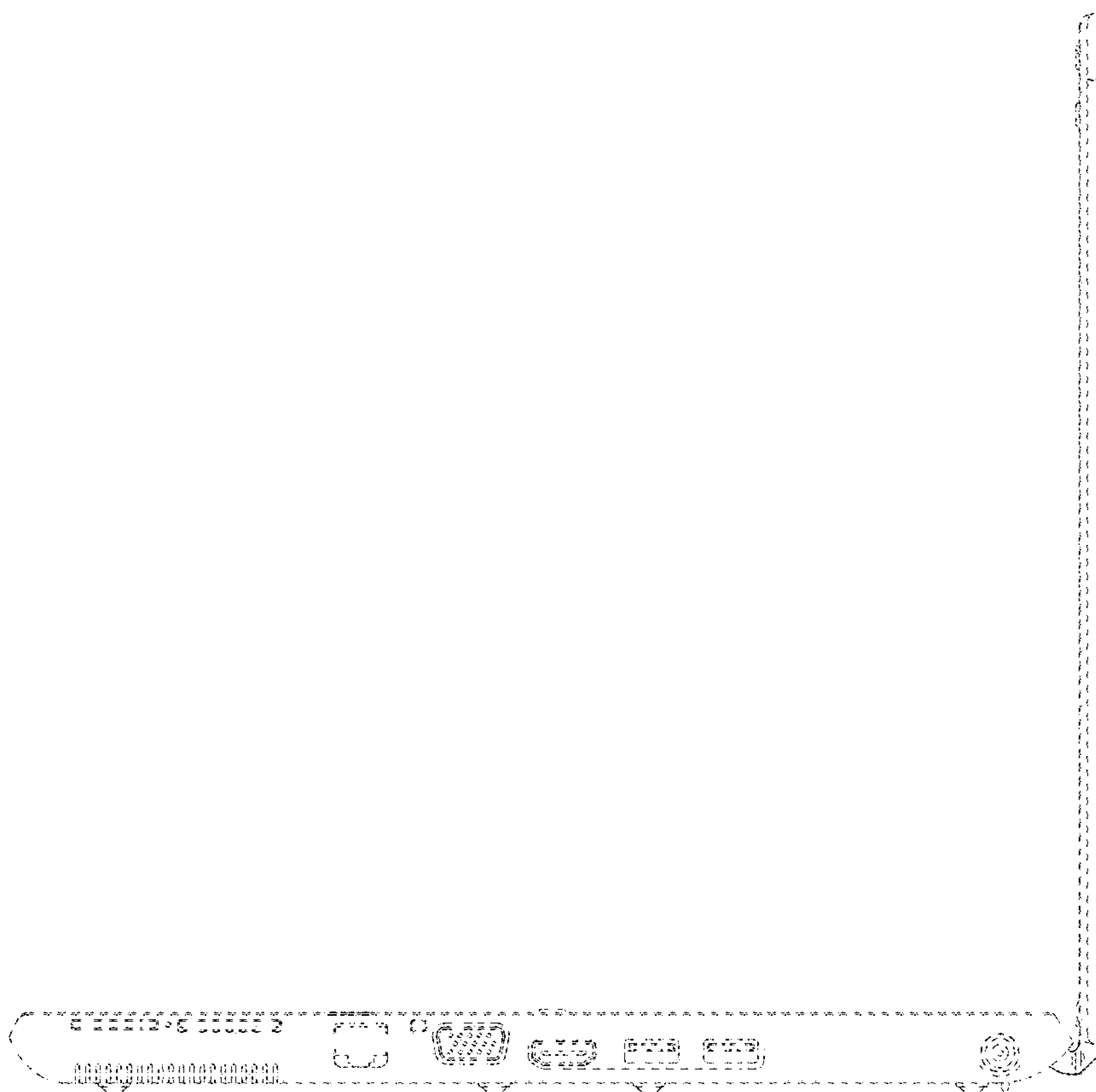
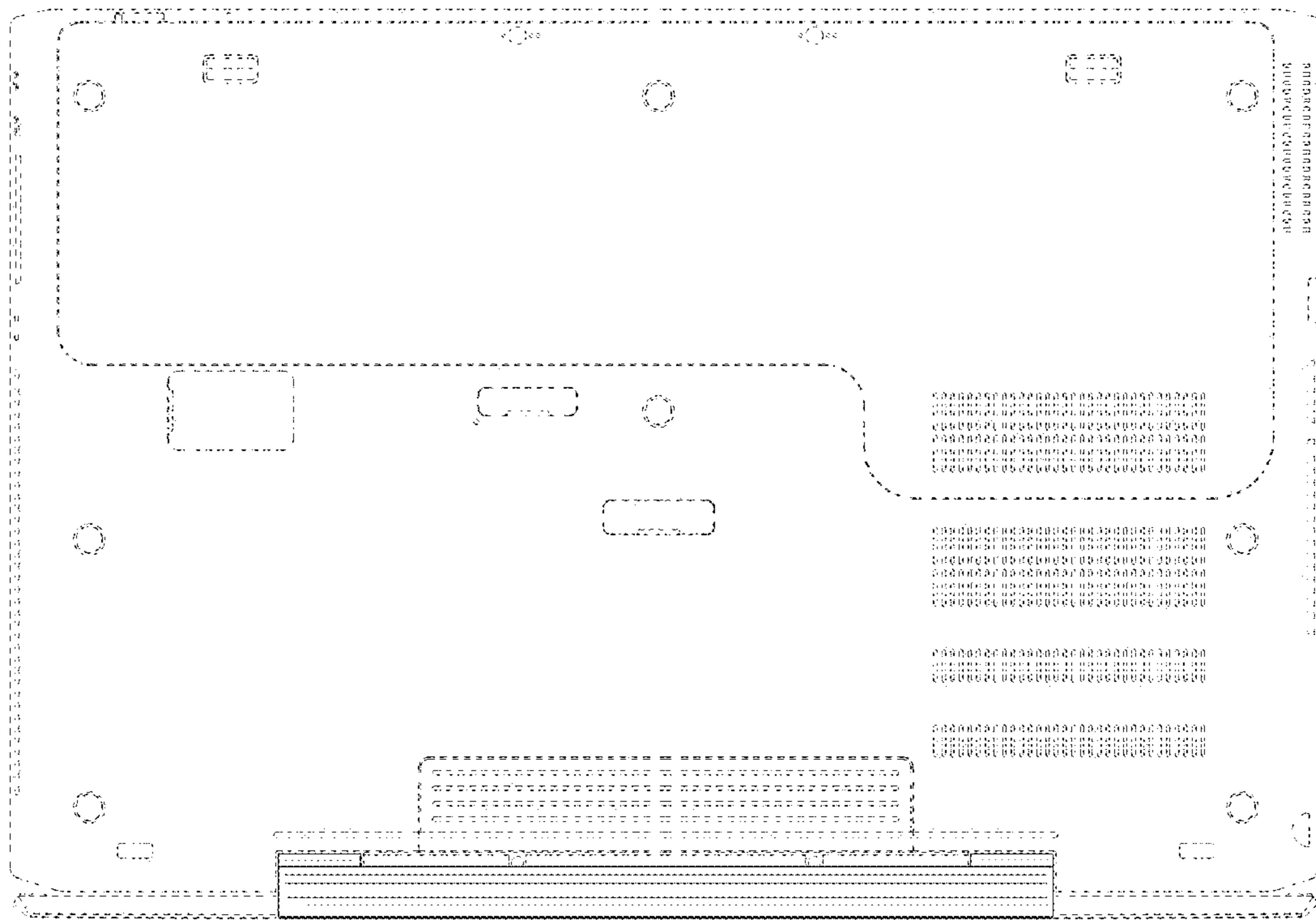

FIG.27



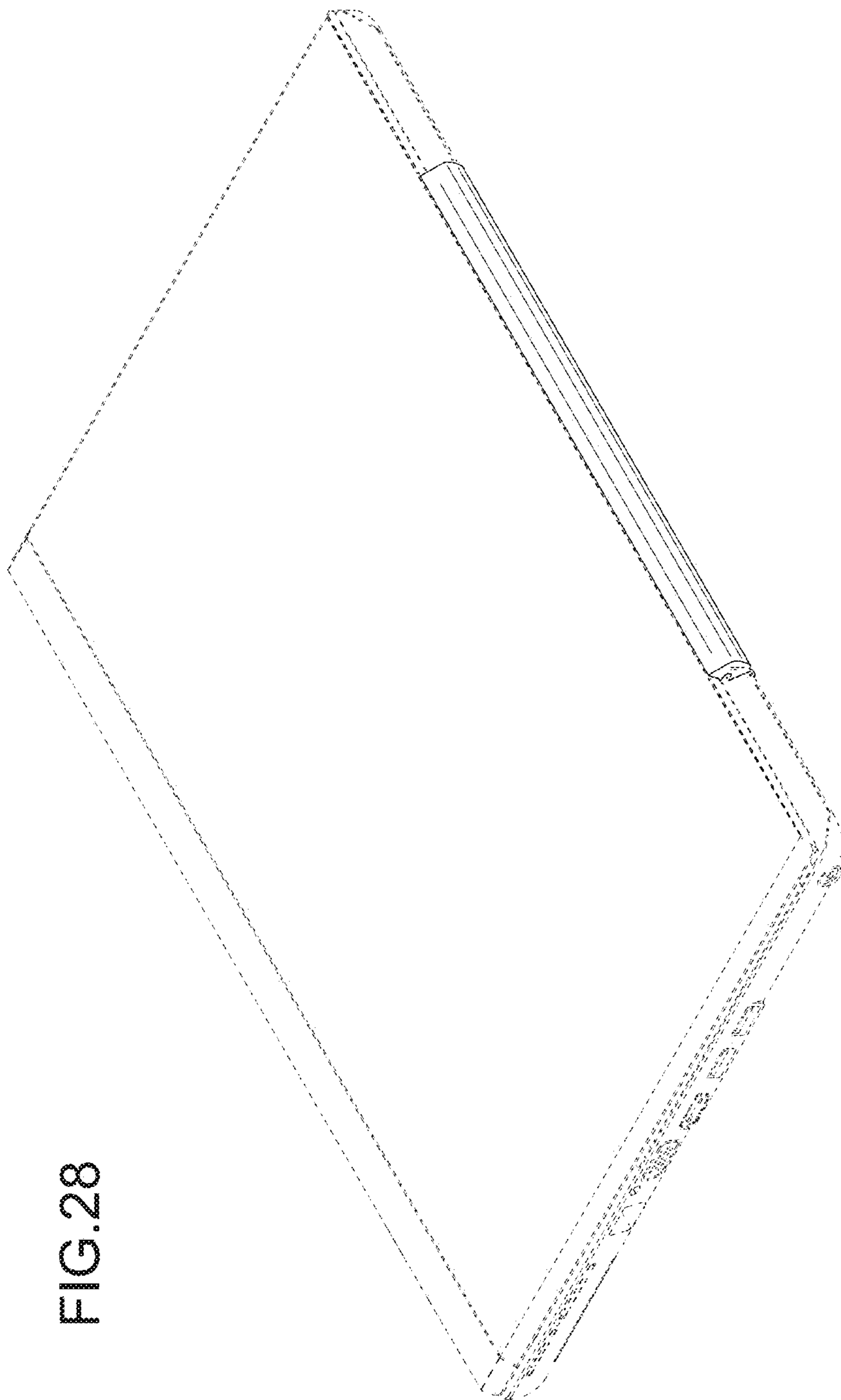

FIG.28

FIG.29

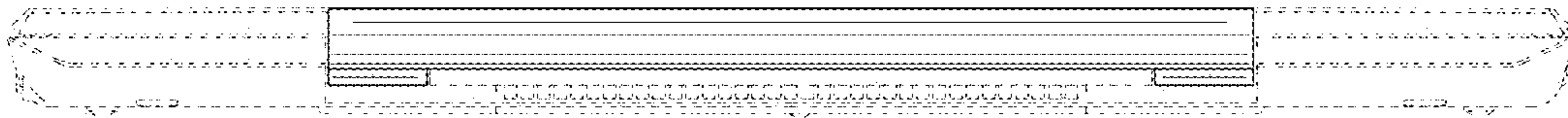

FIG.30

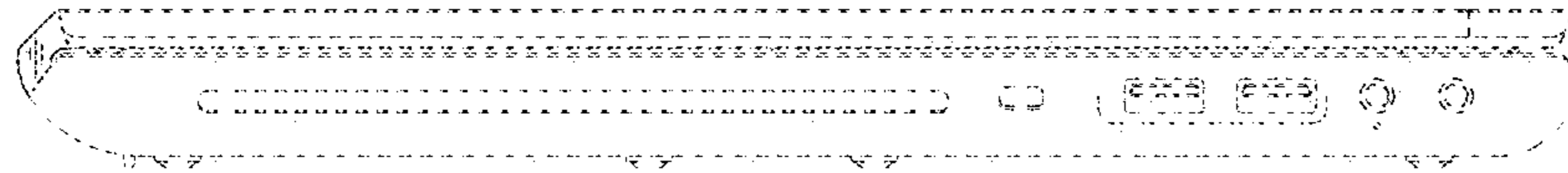

FIG.31

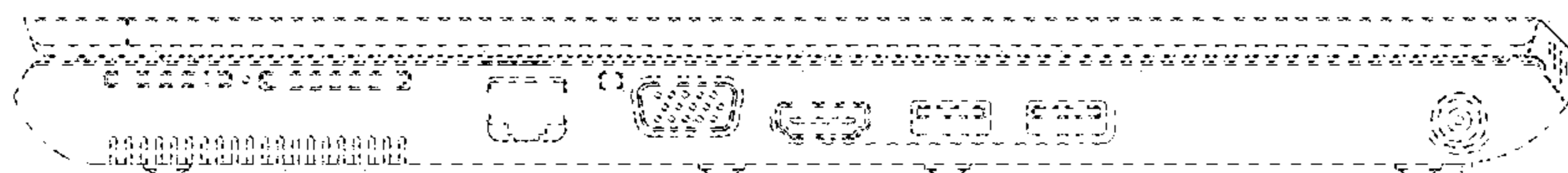

FIG.32

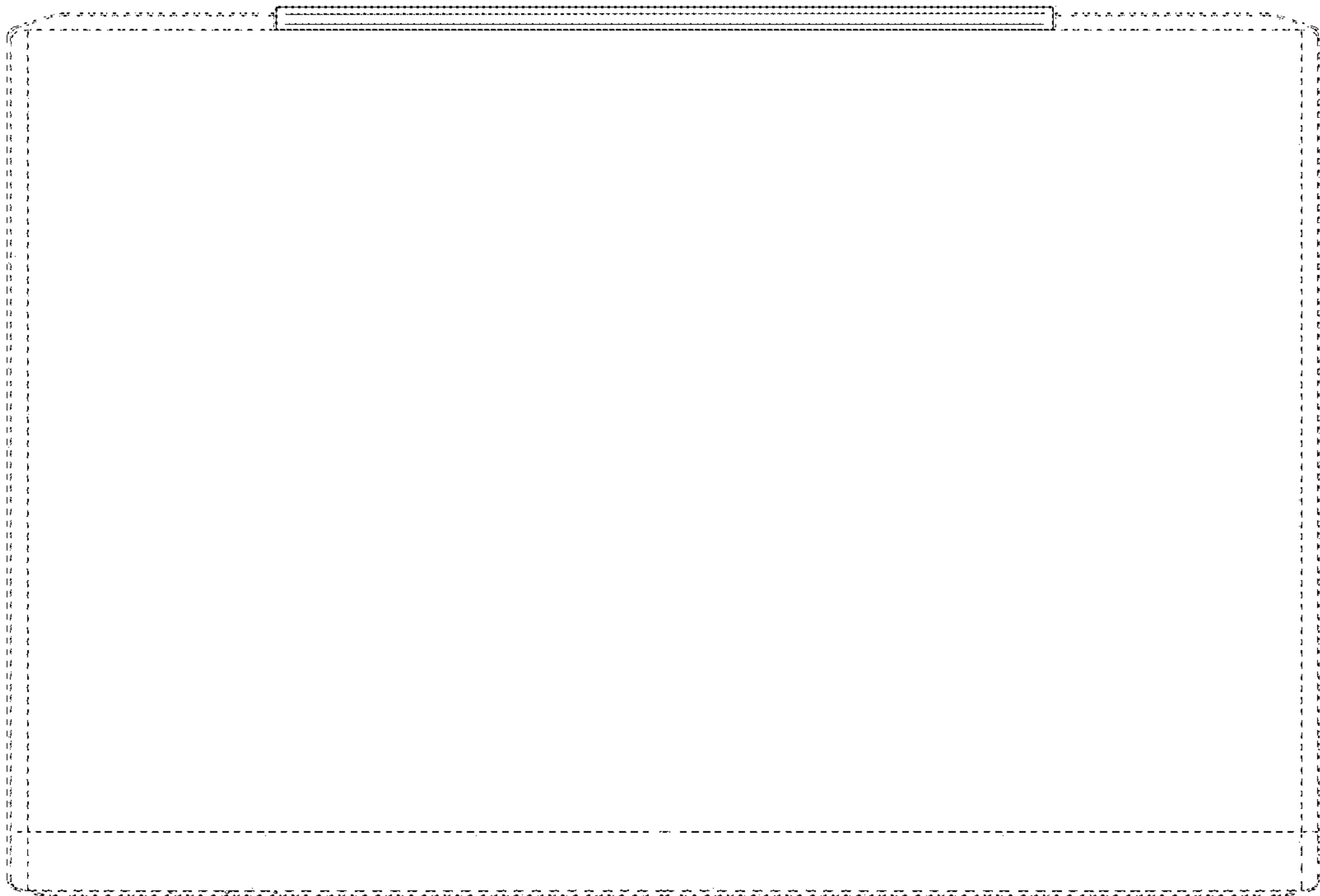

FIG.33

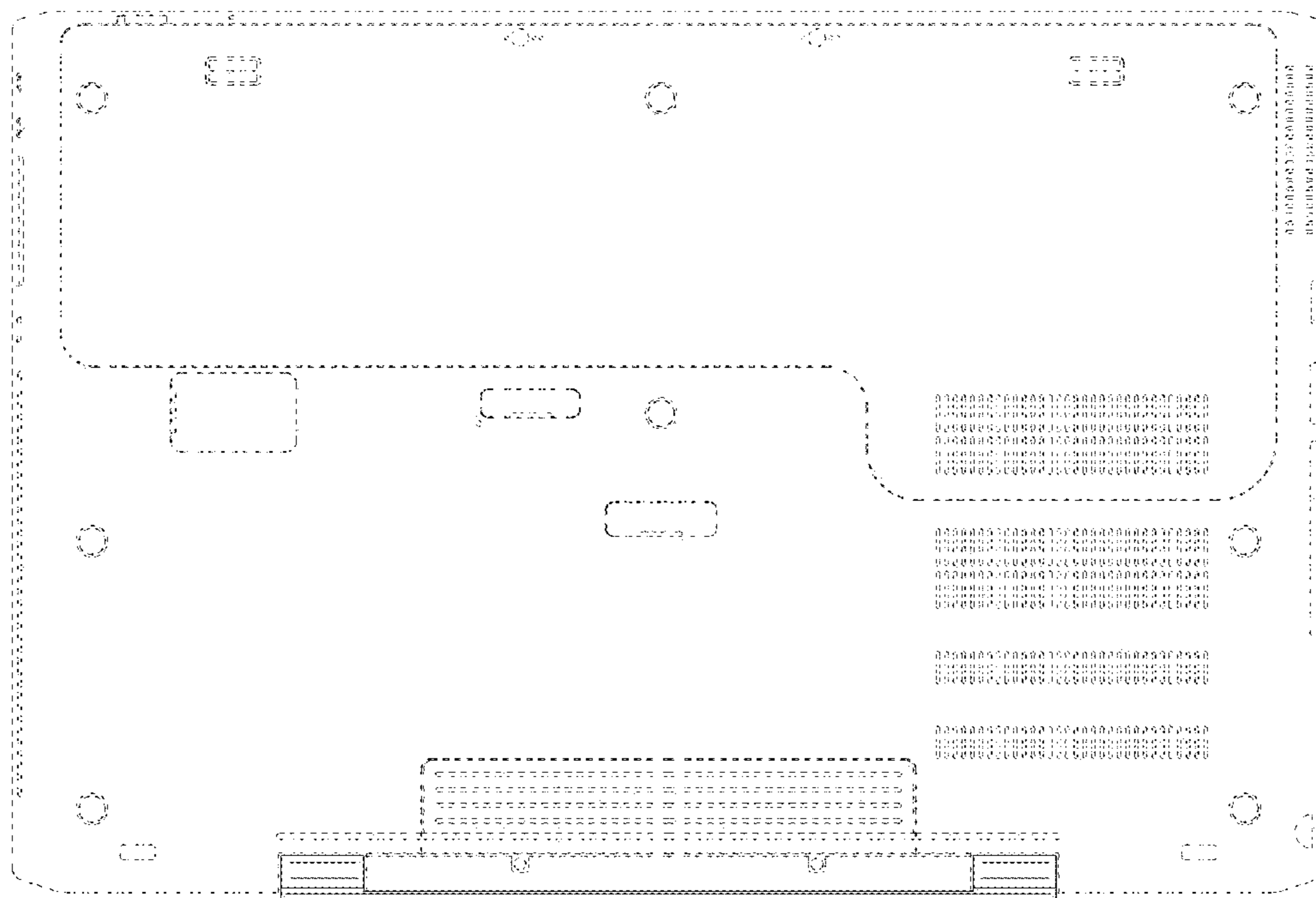

FIG.34

