



US00D705750S

(12) **United States Design Patent**
Wu et al.

(10) **Patent No.:** **US D705,750 S**

(45) **Date of Patent:** **** May 27, 2014**

(54) **EARPHONE**

(71) Applicant: **Shenzhen Grandsun Electronic Co., Ltd.**, Guangdong (CN)

(72) Inventors: **Charles Wu**, Guangdong (CN); **Steven Shi**, Guangdong (CN); **Wenlong Zheng**, Guangdong (CN); **Wenyang Yang**, Guangdong (CN); **Wanquan Zhou**, Guangdong (CN); **Bo Xiang**, Guangdong (CN)

(73) Assignee: **Shenzhen Grandsun Electronics Co., Ltd.**, Shenzhen, Guangdong (CN)

(**) Term: **14 Years**

(21) Appl. No.: **29/454,400**

(22) Filed: **May 9, 2013**

(30) **Foreign Application Priority Data**

Mar. 1, 2013 (CN) 2013 3 0050369

(51) **LOC (10) Cl.** **14-01**

(52) **U.S. Cl.**
CPC **H04R 1/1066** (2013.01)
USPC **D14/205**

(58) **Field of Classification Search**
CPC H04R 1/1066
USPC D14/205, 372; D29/112; 2/209;
181/129, 130, 135; 381/380, 381, 379,
381/374, 383; 455/90.3, 575.1
See application file for complete search history.

(56) **References Cited**

U.S. PATENT DOCUMENTS

D328,074 S * 7/1992 Yamazaki et al. D14/205
D345,162 S * 3/1994 Yamatogi D14/205

D358,388 S * 5/1995 Nakamura et al. D14/205
D386,181 S * 11/1997 Fisher D14/205
D430,140 S * 8/2000 Roman D14/205
6,295,366 B1 * 9/2001 Haller et al. 381/374
D484,485 S * 12/2003 Matsuoka D14/205
D534,155 S * 12/2006 Obata D14/205
D538,261 S * 3/2007 Taylor et al. D14/205
D540,301 S * 4/2007 Obata D14/205
D563,382 S * 3/2008 Wikel D14/205
D583,800 S * 12/2008 Jaakkola et al. D14/205
D628,554 S * 12/2010 Tedja et al. D14/205
D637,176 S * 5/2011 Brunner et al. D14/205
D657,344 S * 4/2012 Brunner et al. D14/205
D663,716 S * 7/2012 Hardi et al. D14/205
D666,991 S * 9/2012 Lee et al. D14/205
D673,518 S * 1/2013 Tan D14/205
D673,520 S * 1/2013 Tan D14/205
D677,648 S * 3/2013 Lee et al. D14/206
D683,329 S * 5/2013 Hagelin D14/205
D691,984 S * 10/2013 Wang D14/205
D693,791 S * 11/2013 Troy D14/205

* cited by examiner

Primary Examiner — Paula Greene

(74) *Attorney, Agent, or Firm* — Rankin, Hill & Clark LLP

(57) **CLAIM**

The ornamental design for an “earphone,” as shown and described.

DESCRIPTION

FIG. 1 is a perspective view of the earphone;
FIG. 2 is a front view of the earphone;
FIG. 3 is a rear view of the earphone;
FIG. 4 is a left side view of the earphone;
FIG. 5 is a right side view of the earphone;
FIG. 6 is a top view of the earphone; and,
FIG. 7 is a bottom view of the earphone.

1 Claim, 7 Drawing Sheets

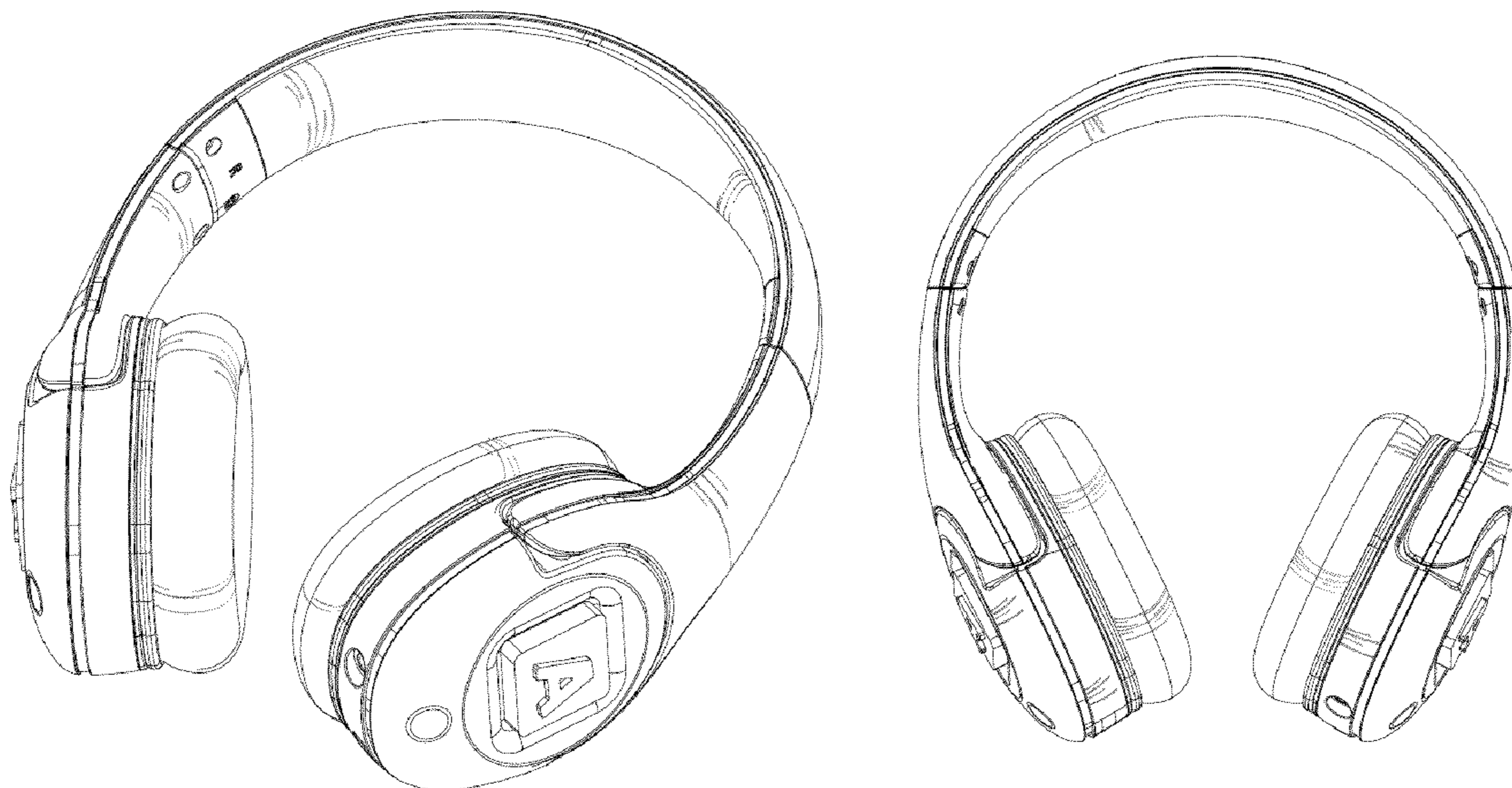



Fig. 1

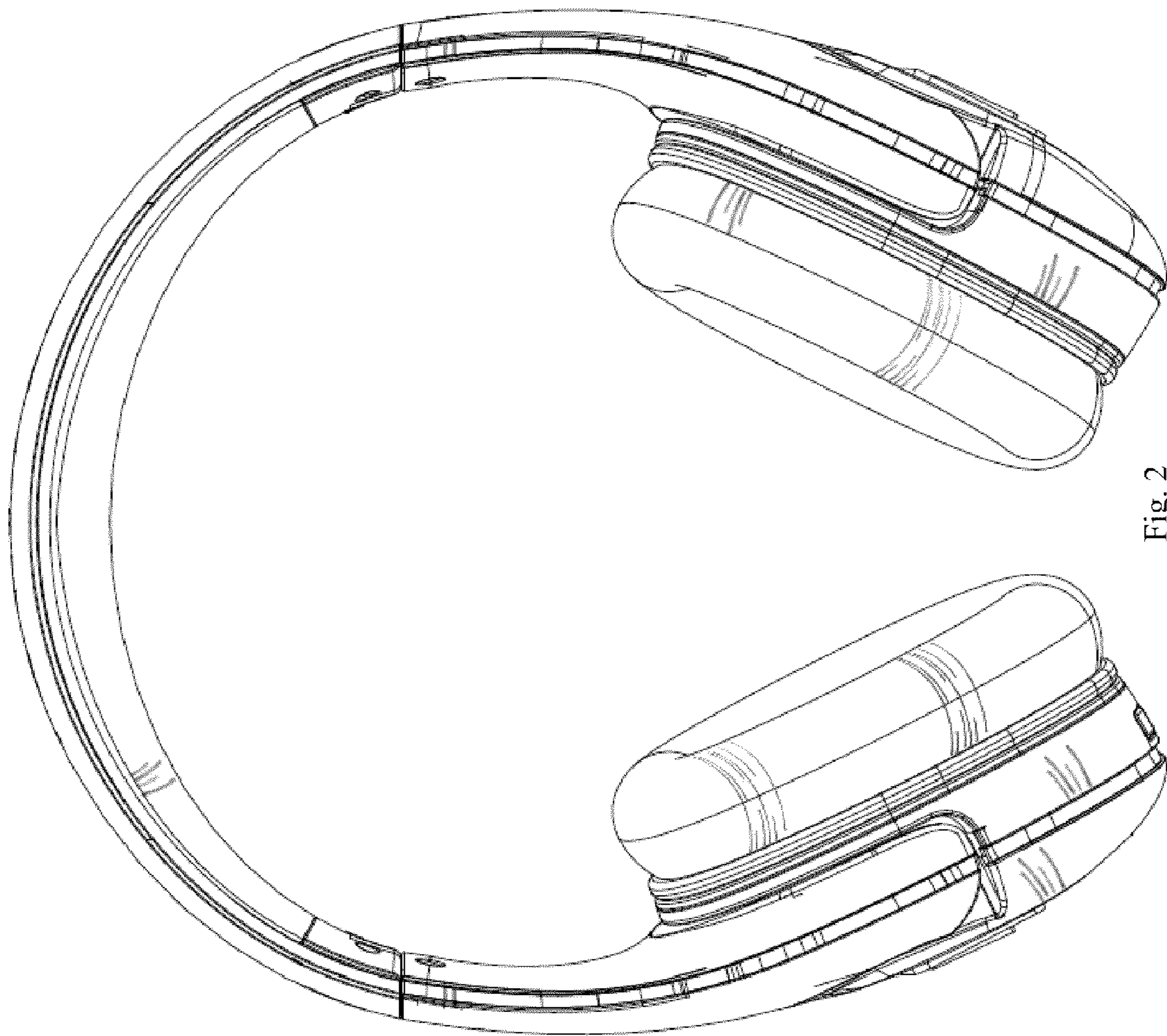

Fig. 2

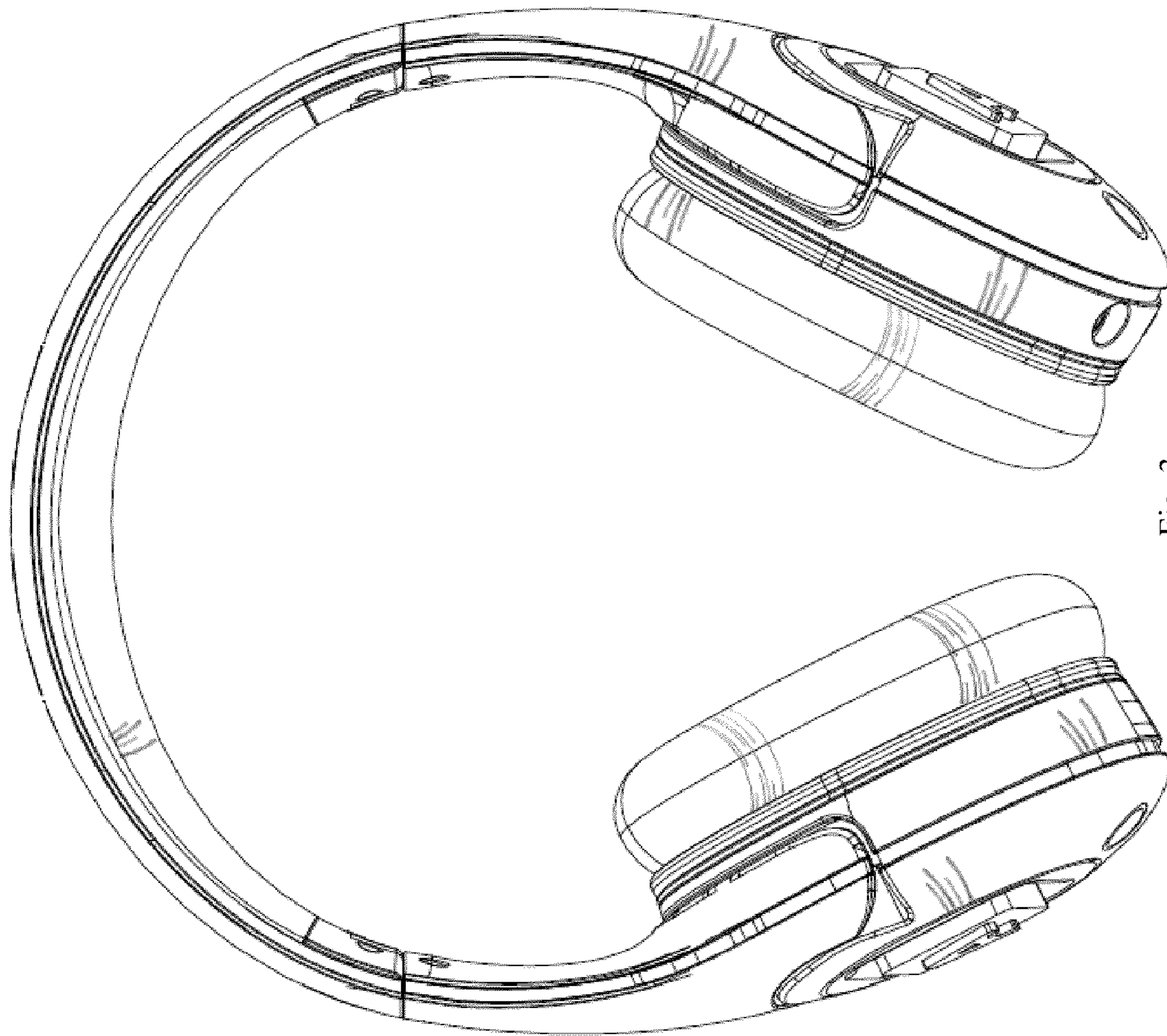

Fig. 3



Fig. 4

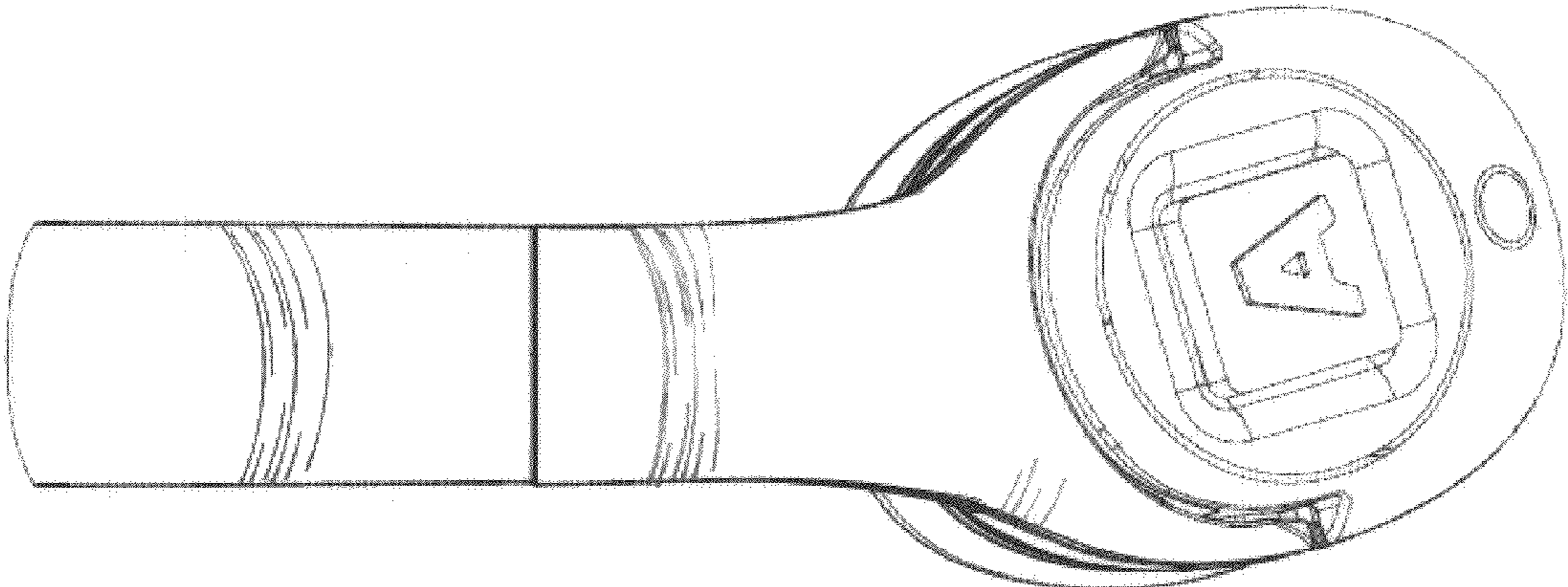

Fig. 5

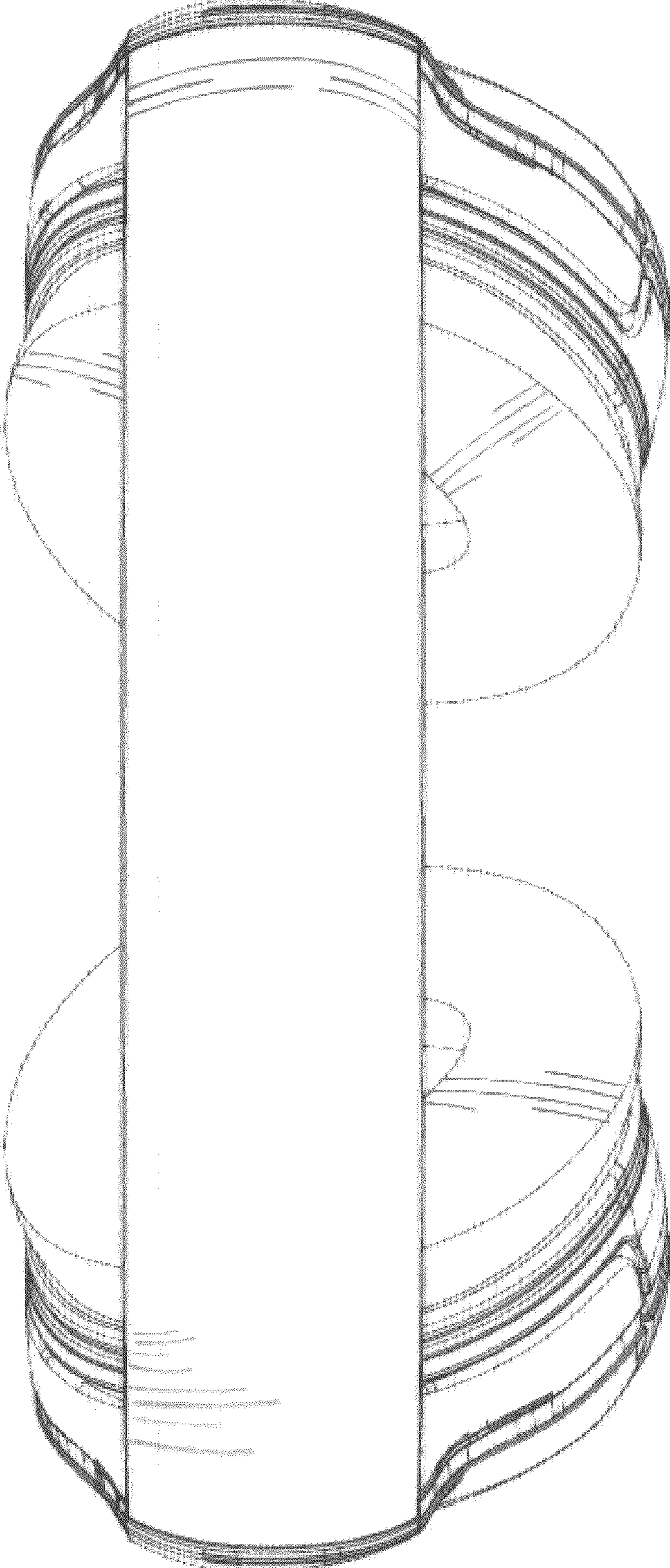

Fig. 6

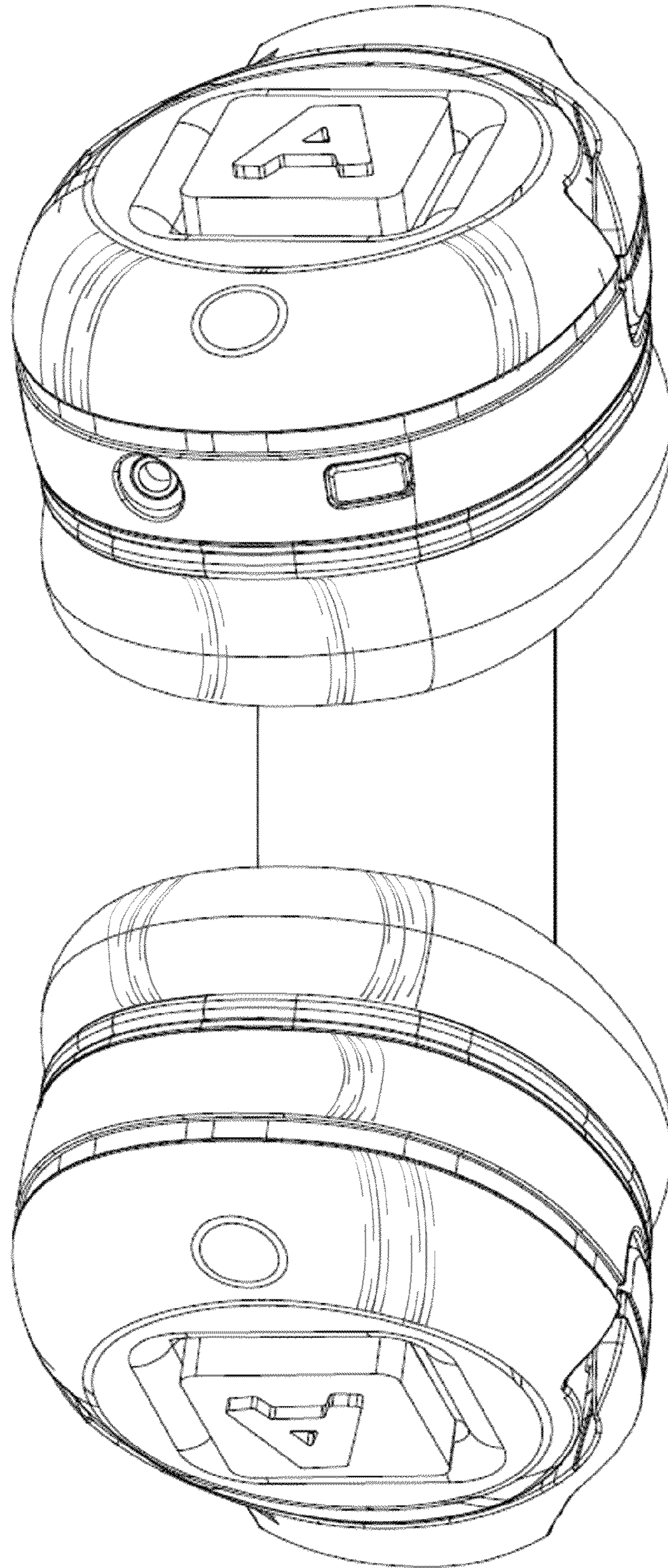

Fig. 7

UNITED STATES PATENT AND TRADEMARK OFFICE
CERTIFICATE OF CORRECTION

PATENT NO. : D705,750 S
APPLICATION NO. : 29/454400
DATED : May 27, 2014
INVENTOR(S) : Charles Wu et al.

Page 1 of 1

It is certified that error appears in the above-identified patent and that said Letters Patent is hereby corrected as shown below:

On the Title Page

Item (73) Assignee

Change "Shenzhen Grandsun Electronics Co., Ltd." to --Shenzhen Grandsun Electronic Co., Ltd.--

Signed and Sealed this
Twenty-fourth Day of March, 2020

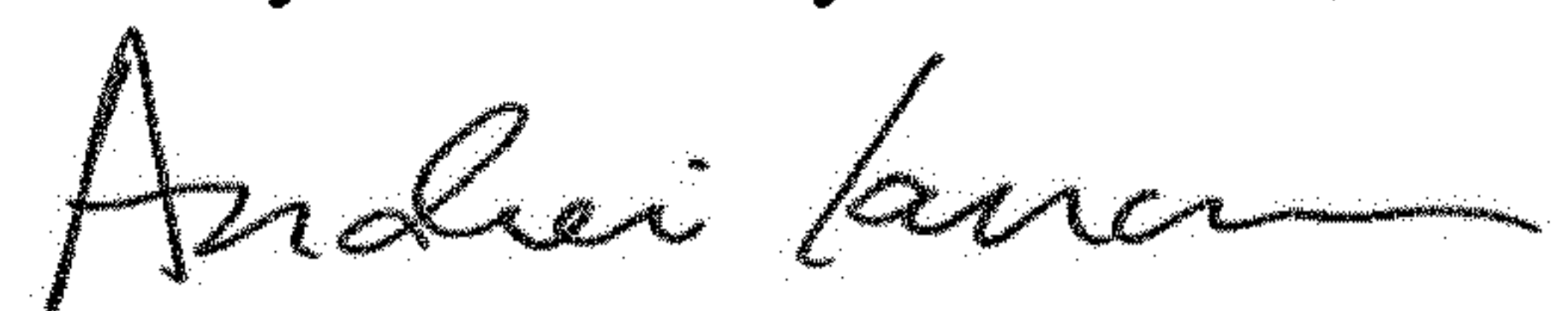

Andrei Iancu
Director of the United States Patent and Trademark Office