



US00D705746S

(12) **United States Design Patent**
Lin et al.

(10) **Patent No.:** **US D705,746 S**

(45) **Date of Patent:** **** May 27, 2014**

(54) **CLOUD TELEVISION BOX**

(56) **References Cited**

(71) Applicant: **Gadmei Electronics Technology Co., Ltd.**, Guangdong (CN)

U.S. PATENT DOCUMENTS

(72) Inventors: **Hui Lin**, Guangdong (CN); **Zhihua Zhang**, Guangdong (CN); **Yu Wang**, Guangdong (CN)

D570,114 S *	6/2008	Netz	D3/294
D644,192 S *	8/2011	McManigal et al.	D14/125
D648,722 S *	11/2011	Meyerhoffer et al.	D14/346
D650,377 S *	12/2011	Akana et al.	D14/314
D657,784 S *	4/2012	Akana et al.	D14/314
D661,670 S *	6/2012	Huang	D14/125
D666,563 S *	9/2012	Lee	D14/125

(73) Assignee: **Gadmei Electronics Technology Co., Ltd.**, Qingyuan (CN)

* cited by examiner

(**) Term: **14 Years**

Primary Examiner — Randall Gholson

(21) Appl. No.: **29/443,503**

(57) **CLAIM**

The ornamental design for a cloud television box, as shown and described.

(22) Filed: **Jan. 18, 2013**

DESCRIPTION

(30) **Foreign Application Priority Data**

Dec. 13, 2012 (CN) 2012 3 0625251

(51) **LOC (10) Cl.** **14-03**

(52) **U.S. Cl.**
USPC **D14/125**

(58) **Field of Classification Search**
USPC D14/125, 357-358, 496, 188, 242, 432;
D13/184; 348/10, 460, 706, 731;
340/825.03; 455/6.1, 6.2; 312/223.1,
312/7.2

FIG. 1 is a front elevational view of a cloud television box showing our new design;
FIG. 2 is a rear elevational view of the cloud television box thereof;
FIG. 3 is a left side elevational view of the cloud television box thereof;
FIG. 4 is a right side elevational view of the cloud television box thereof;
FIG. 5 is a top plan view of the cloud television box thereof;
FIG. 6 is a bottom plan view of the cloud television box thereof; and,
FIG. 7 is a perspective view of the cloud television box thereof.

See application file for complete search history.

1 Claim, 6 Drawing Sheets

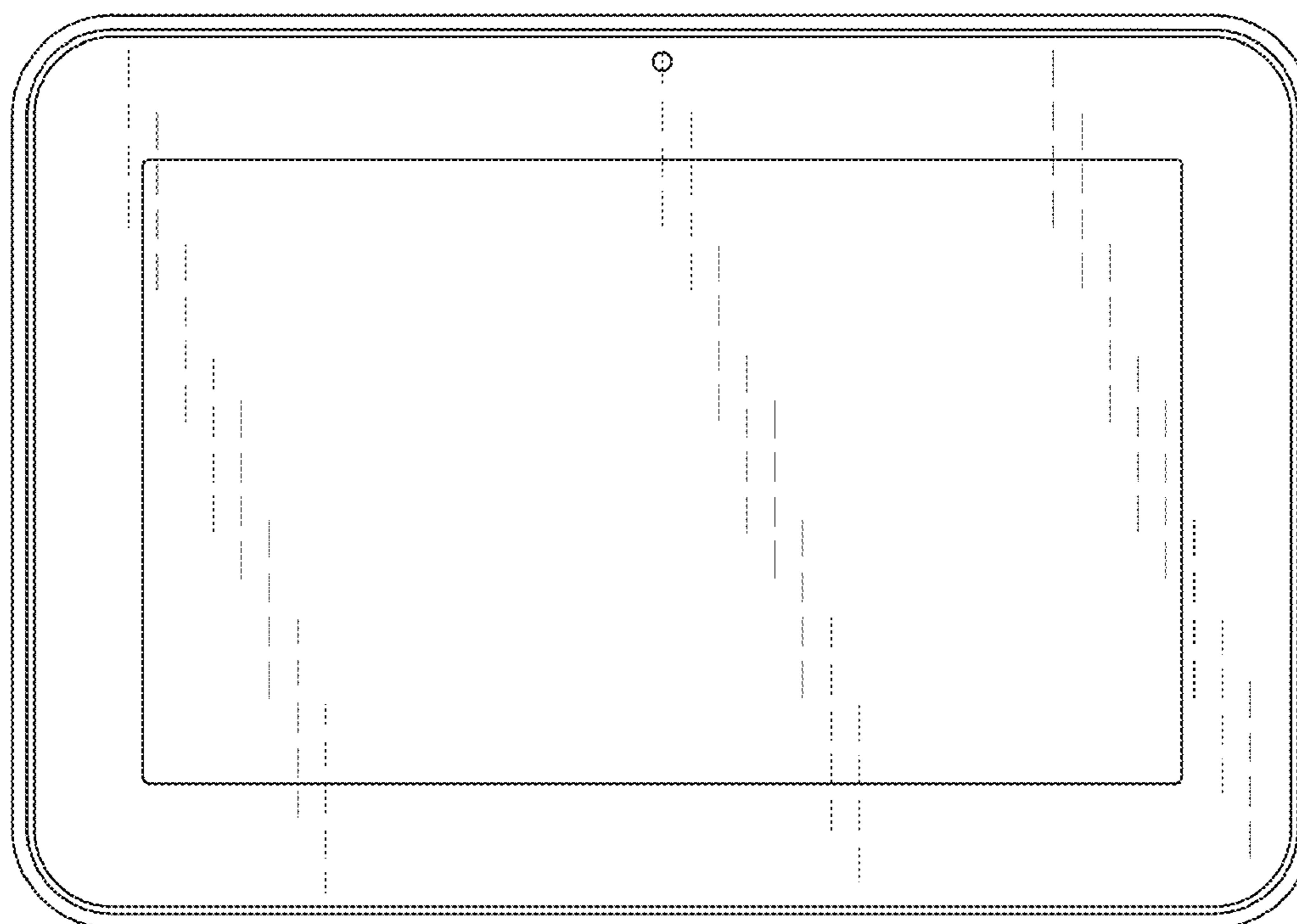

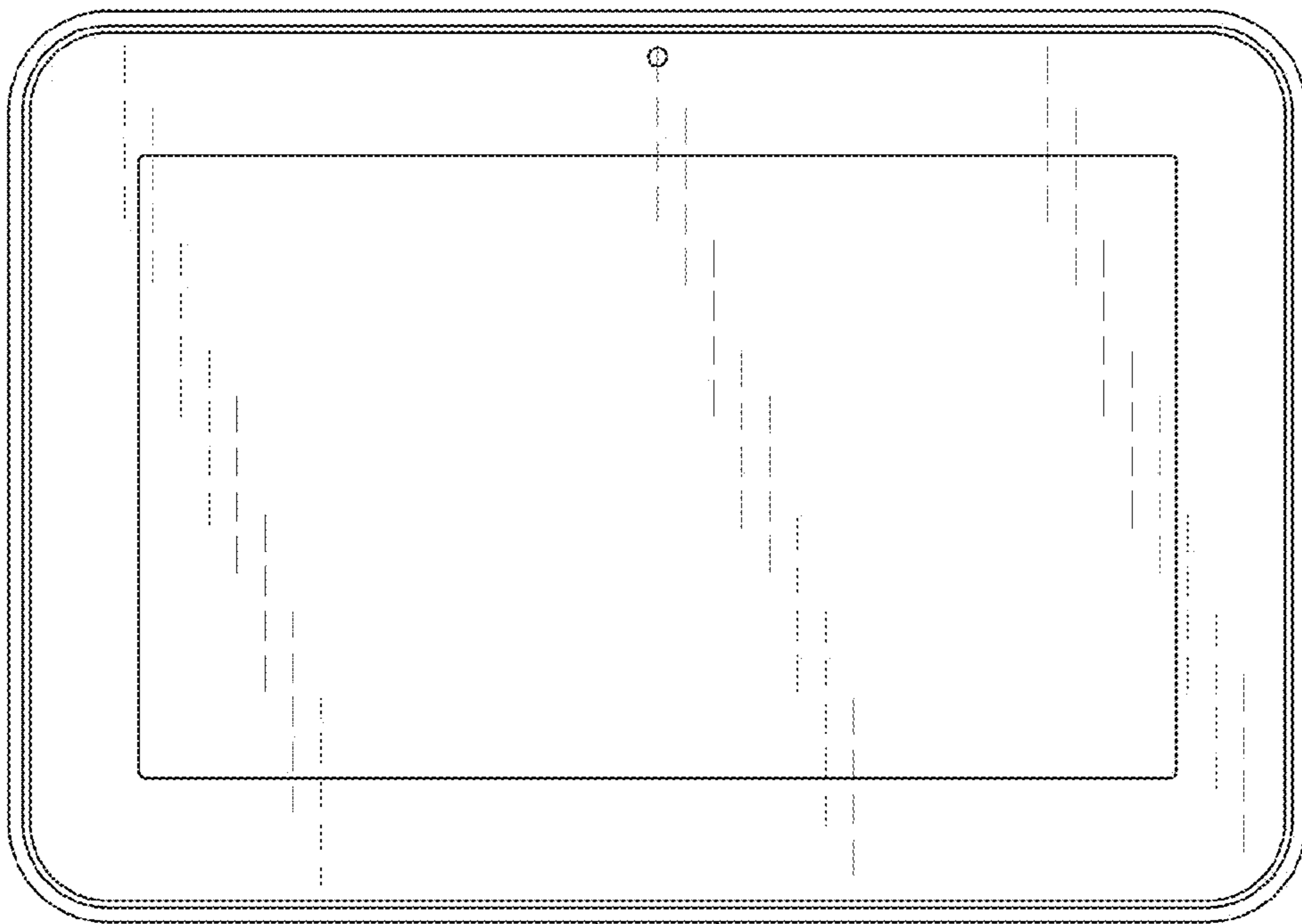

FIG. 1

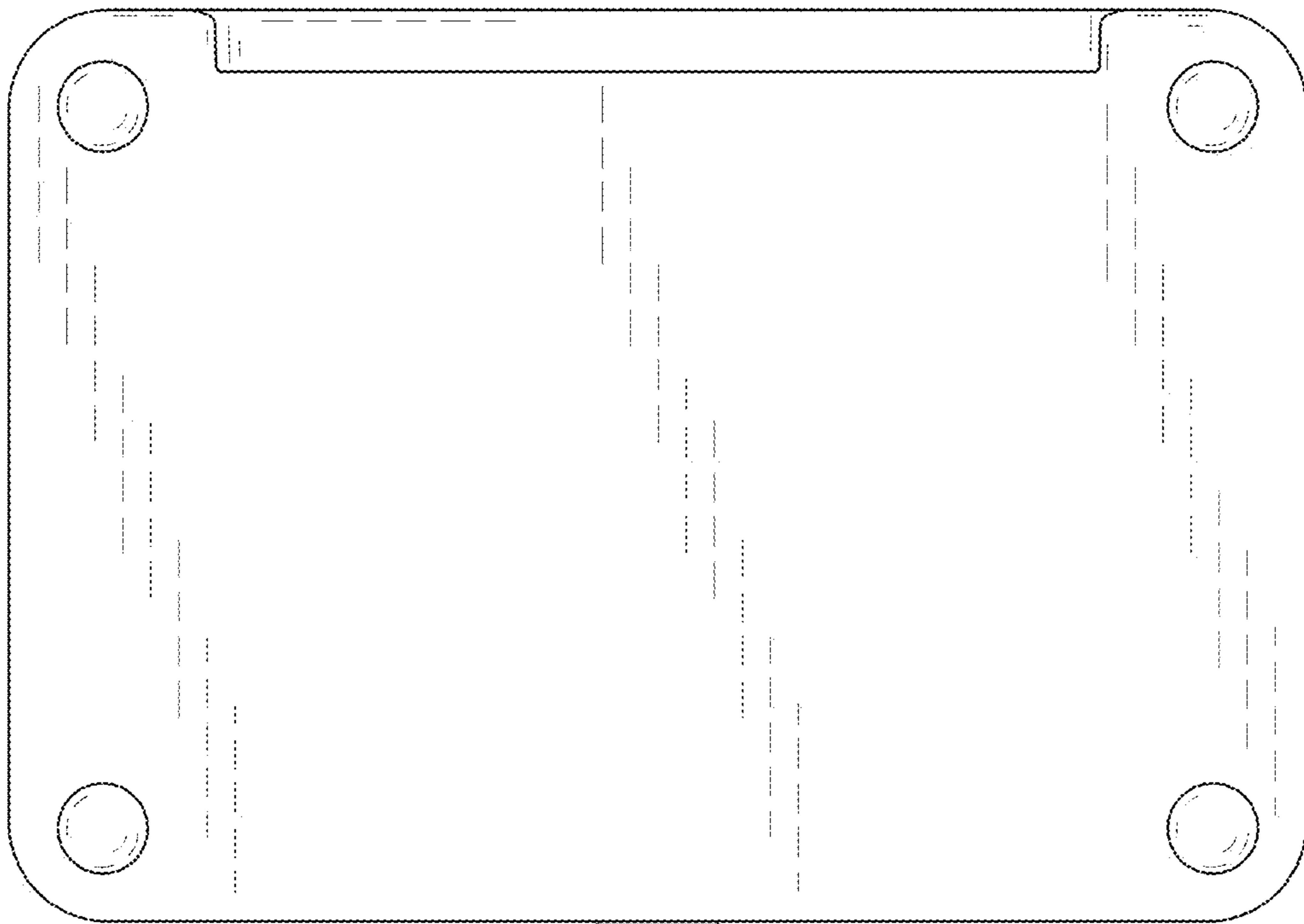

FIG.2

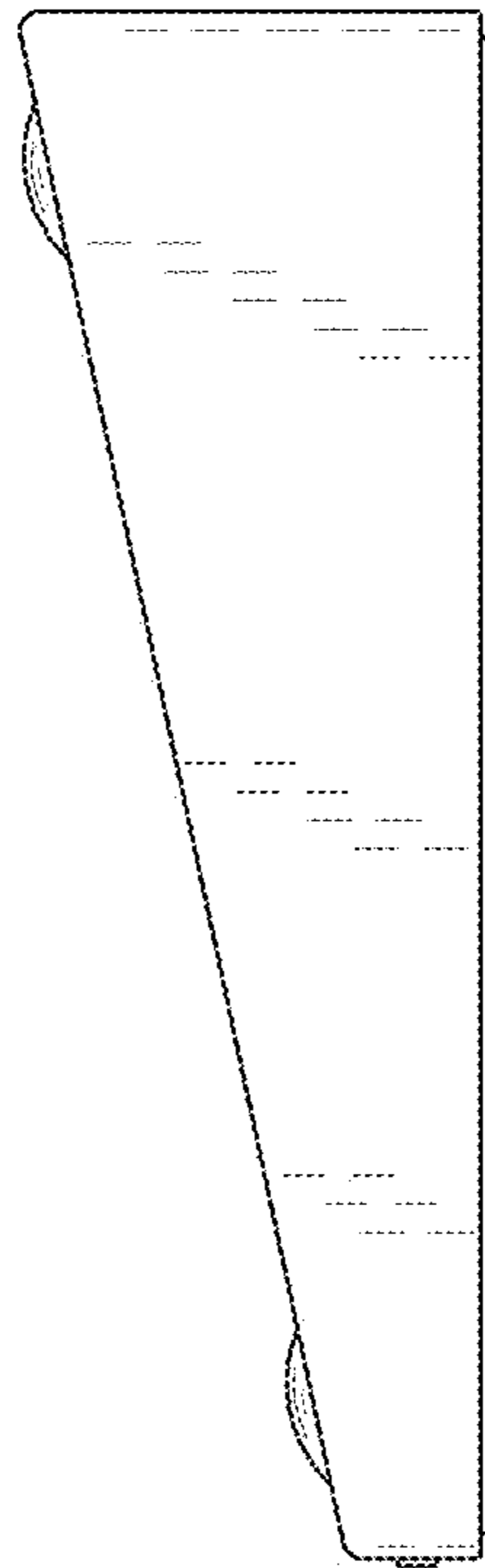

FIG.3

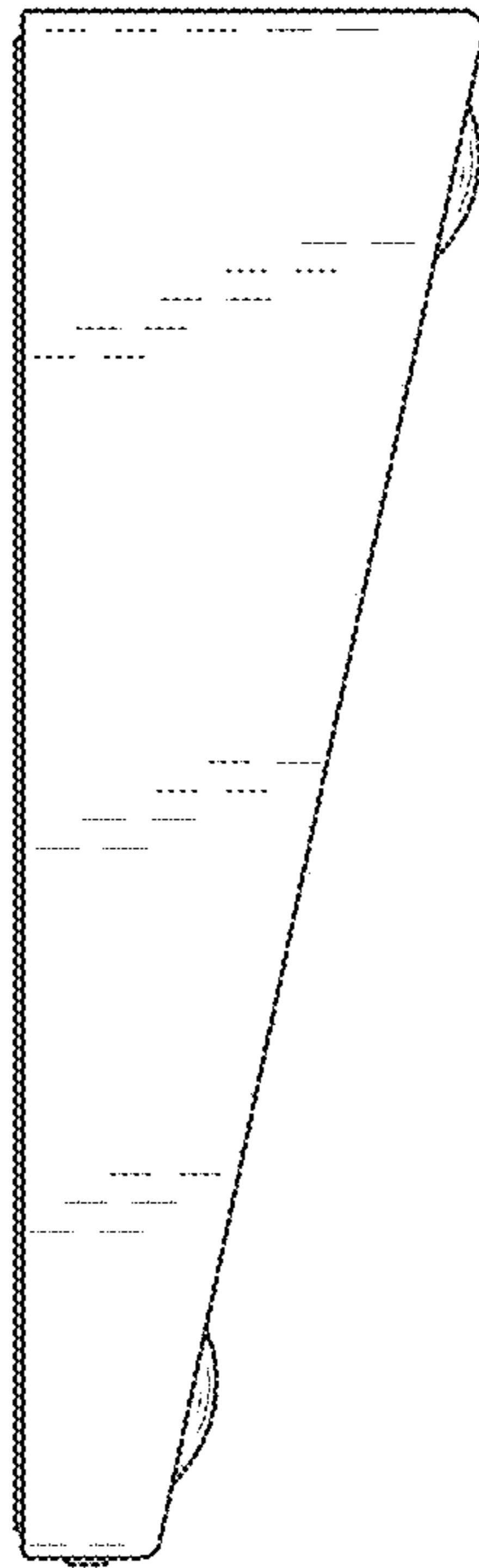

FIG.4

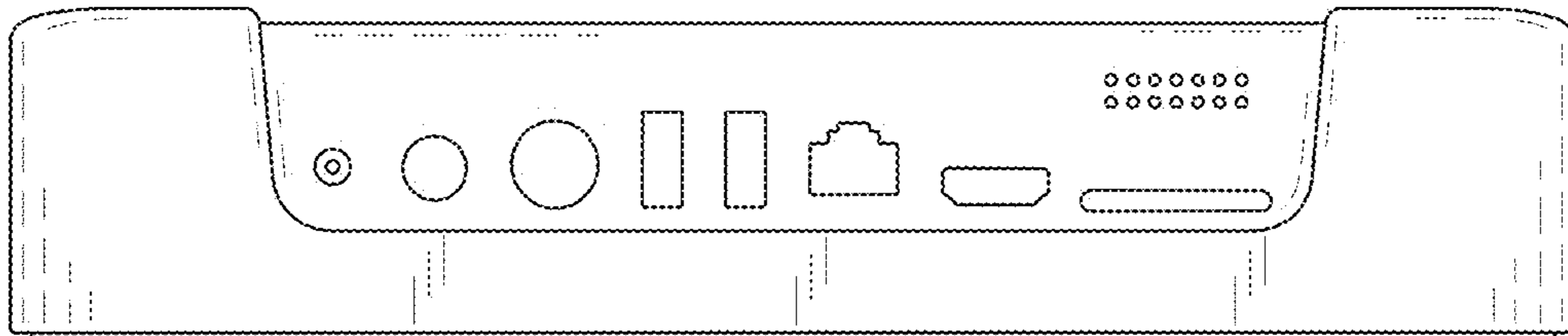

FIG.5

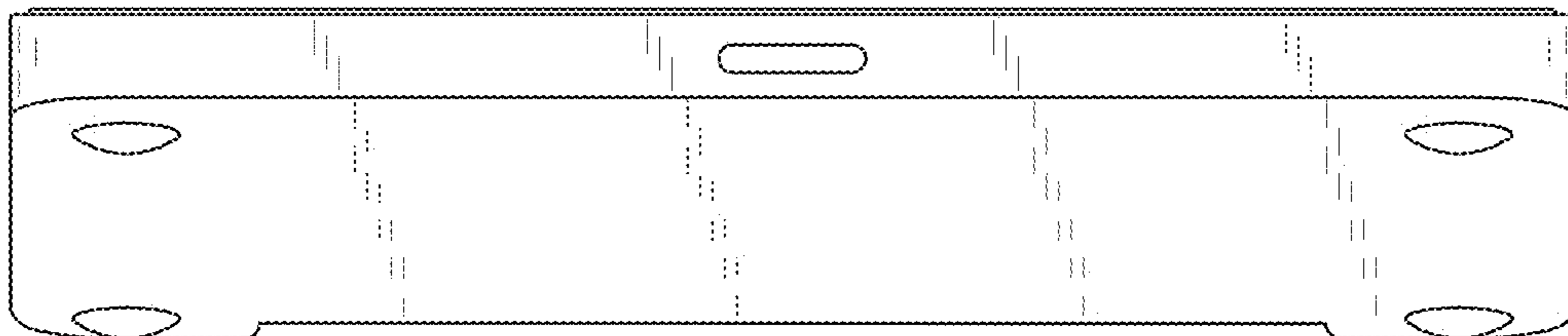

FIG.6

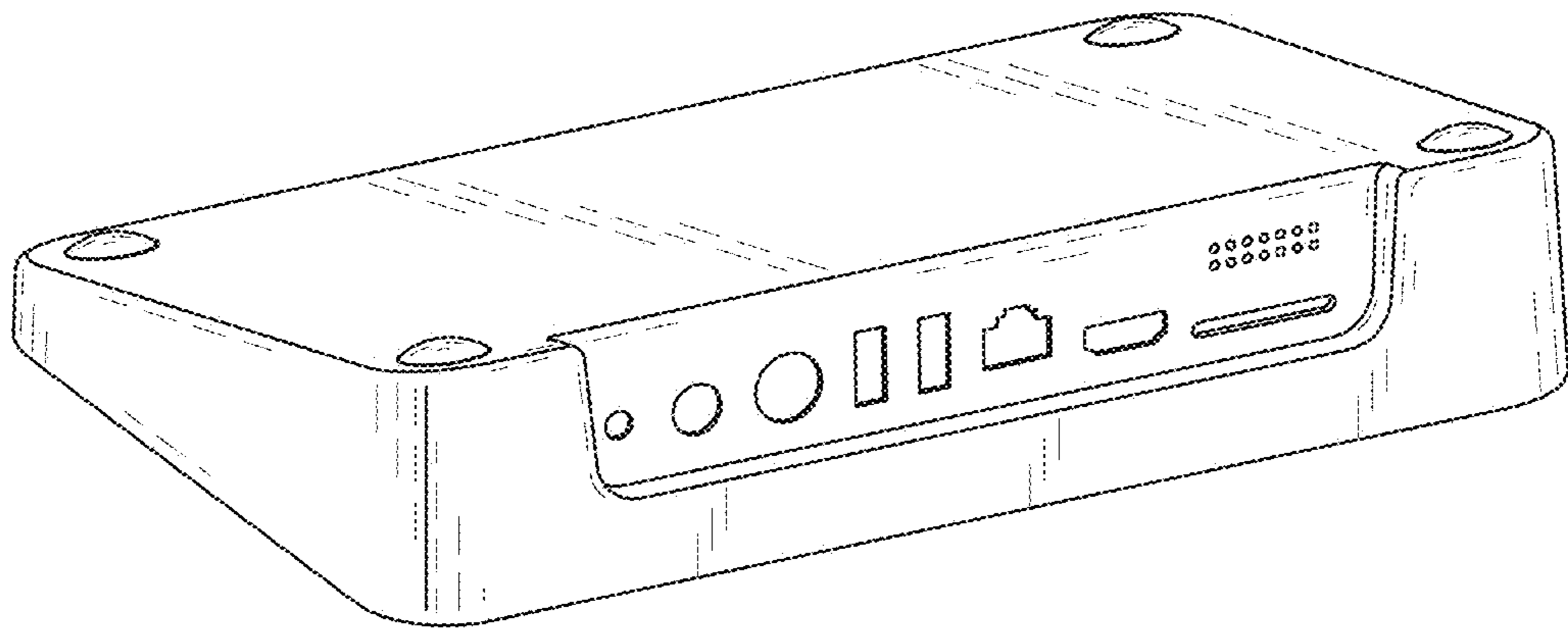

FIG.7