



US00D705728S

(12) **United States Design Patent**
Choi

(10) **Patent No.:** **US D705,728 S**
(45) **Date of Patent:** **** May 27, 2014**

(54) **INVERTER**

(71) Applicant: **LSIS Co., Ltd.**, Anyang-si (KR)

(72) Inventor: **Won Suk Choi**, Seoul (KR)

(73) Assignee: **LSIS Co., Ltd.**, Anyang-si (KR)

(**) Term: **14 Years**

(21) Appl. No.: **29/459,369**

(22) Filed: **Jun. 28, 2013**

(30) **Foreign Application Priority Data**

Jan. 24, 2013 (KR) 30-2013-0004258

(51) **LOC (10) Cl.** **13-02**

(52) **U.S. Cl.**
USPC **D13/110**

(58) **Field of Classification Search**
USPC D13/110, 101, 123, 184, 199;
307/150-152; 361/600, 601, 622, 702,
361/703, 730, 796, 809; 363/141, 142
See application file for complete search history.

(56) **References Cited**

U.S. PATENT DOCUMENTS

4,620,263 A * 10/1986 Ito 361/690
D298,824 S * 12/1988 Kondo et al. D13/110
5,497,289 A * 3/1996 Sugishima et al. 361/709
D372,017 S * 7/1996 Suematsu et al. D13/110

D376,785 S * 12/1996 Ikeda et al. D13/110
D379,963 S * 6/1997 Ikeda et al. D13/110
D380,193 S * 6/1997 Yamaguchi et al. D13/110
6,239,986 B1 * 5/2001 Otsuka 361/796
D449,817 S * 10/2001 Takeuchi et al. D13/110
D455,399 S * 4/2002 Imamura et al. D13/110
D455,714 S * 4/2002 Kim D13/110
D502,916 S * 3/2005 Higuchi et al. D13/110
D558,141 S * 12/2007 Kwon D13/110
D562,234 S * 2/2008 Morihara et al. D13/110
D563,316 S * 3/2008 Higuchi D13/110

* cited by examiner

Primary Examiner — Derrick Holland

(74) *Attorney, Agent, or Firm* — Birch, Stewart, Kolasch & Birch, LLP

(57) **CLAIM**

I claim the ornamental design for an inverter, as shown and described.

DESCRIPTION

FIG. 1 is a perspective view of an inverter showing my new design;
FIG. 2 is a front elevation view thereof;
FIG. 3 is a rear elevation view thereof;
FIG. 4 is a left-side elevation view thereof;
FIG. 5 is a right-side elevation view thereof;
FIG. 6 is a top plan view thereof; and,
FIG. 7 is a bottom plan view thereof.
The broken lines shown are included for the purpose of illustrating the unclaimed portions of the article and form no part of the claim.

1 Claim, 7 Drawing Sheets

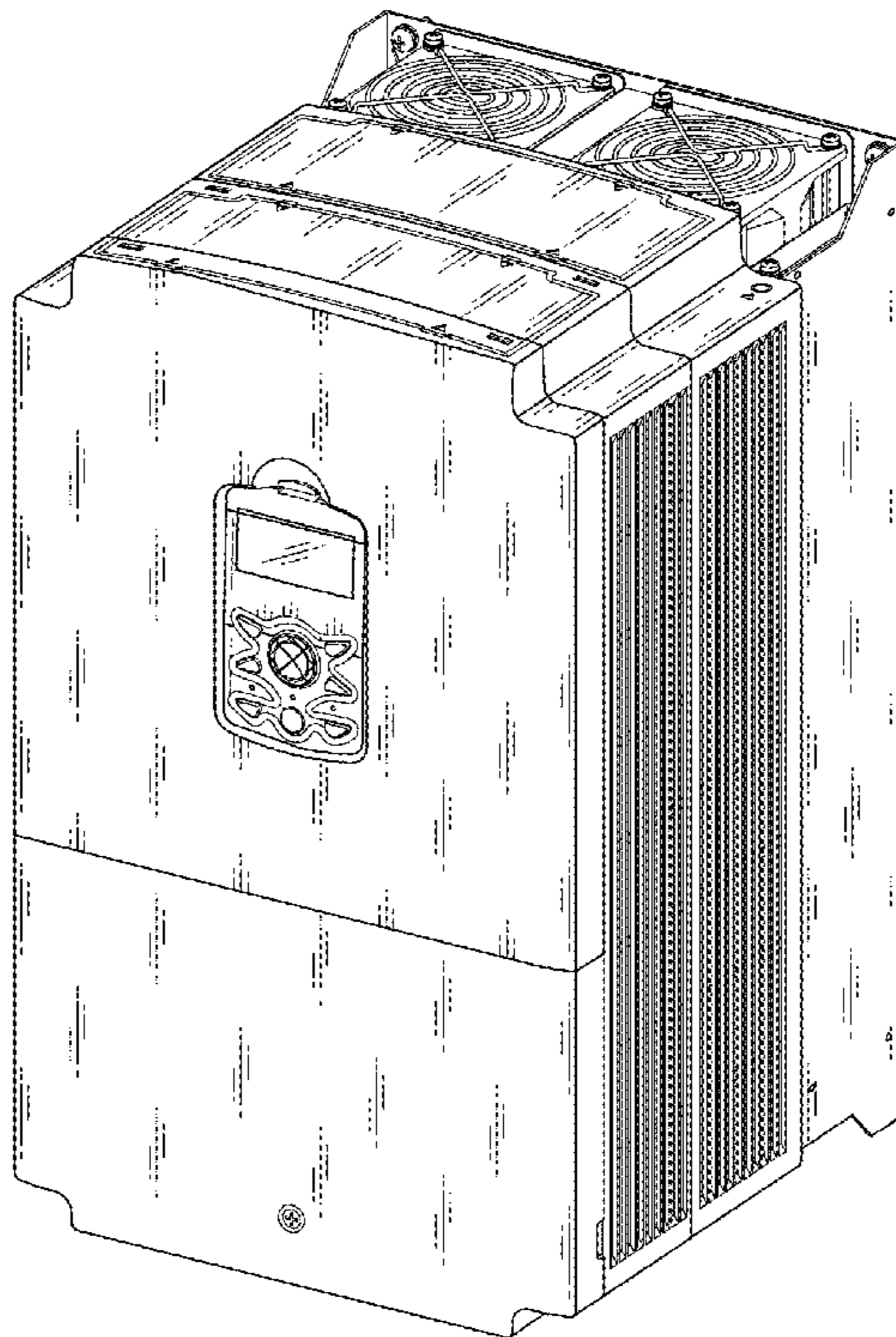

FIG. 1

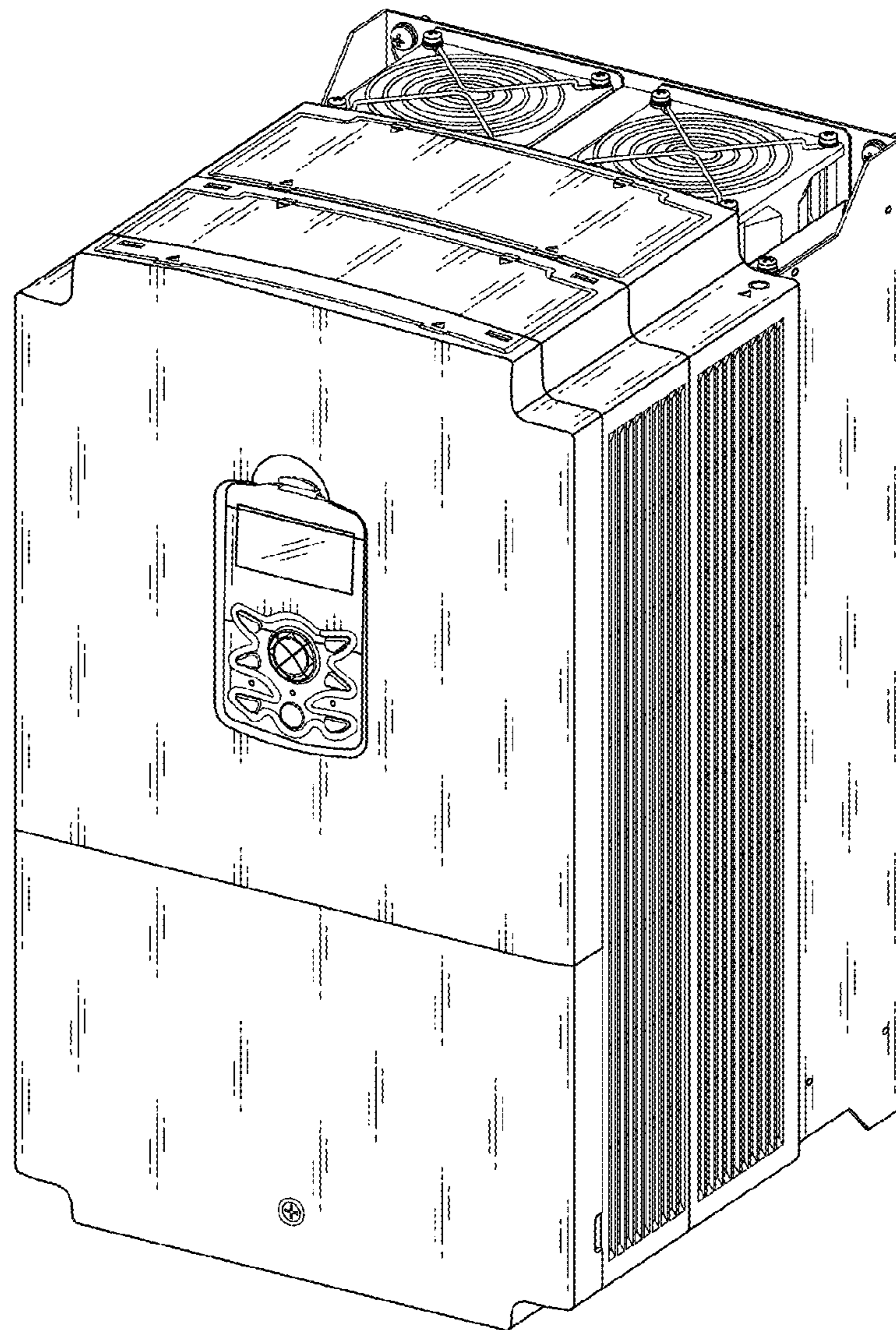

FIG. 2

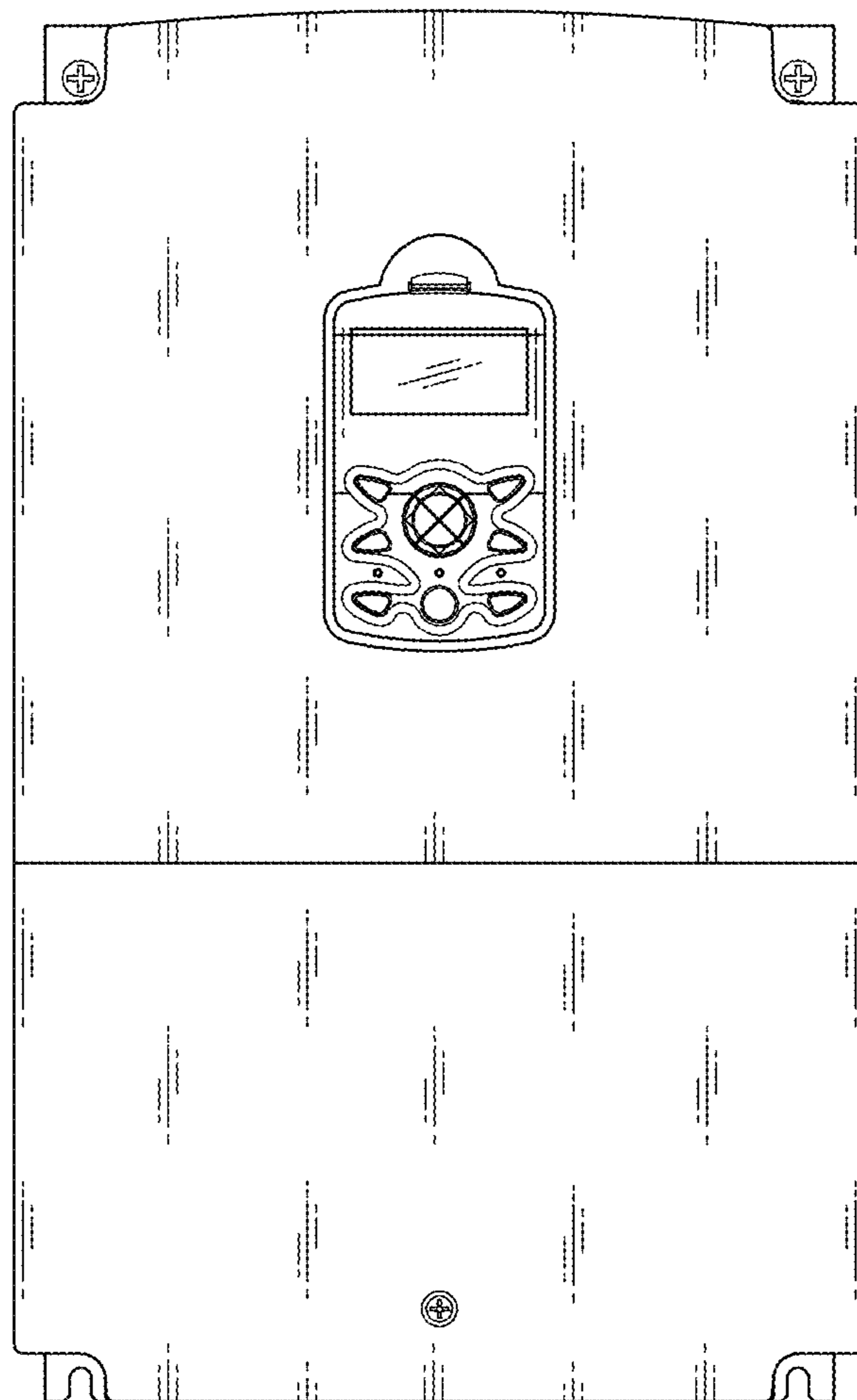

FIG. 3

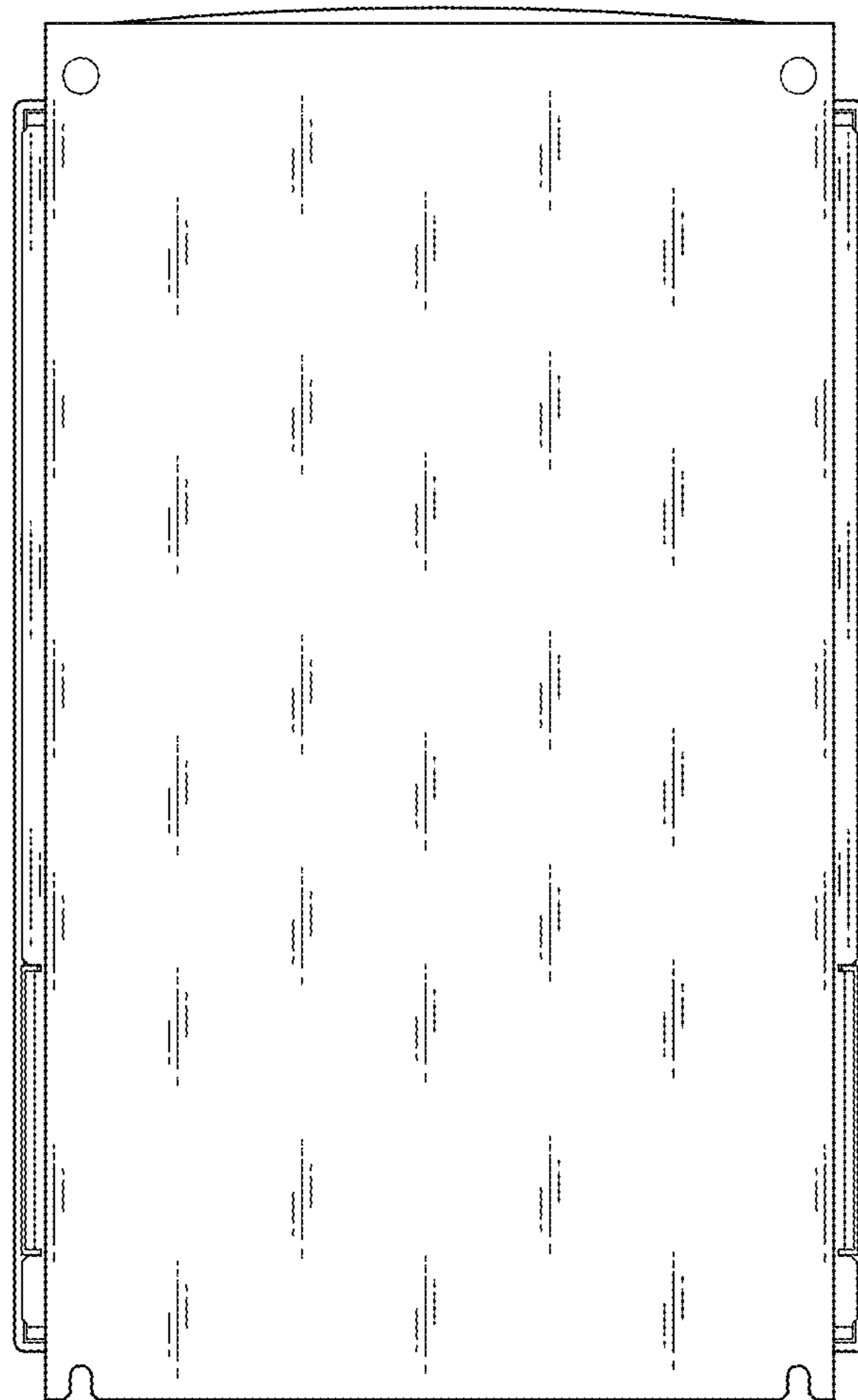

FIG. 4

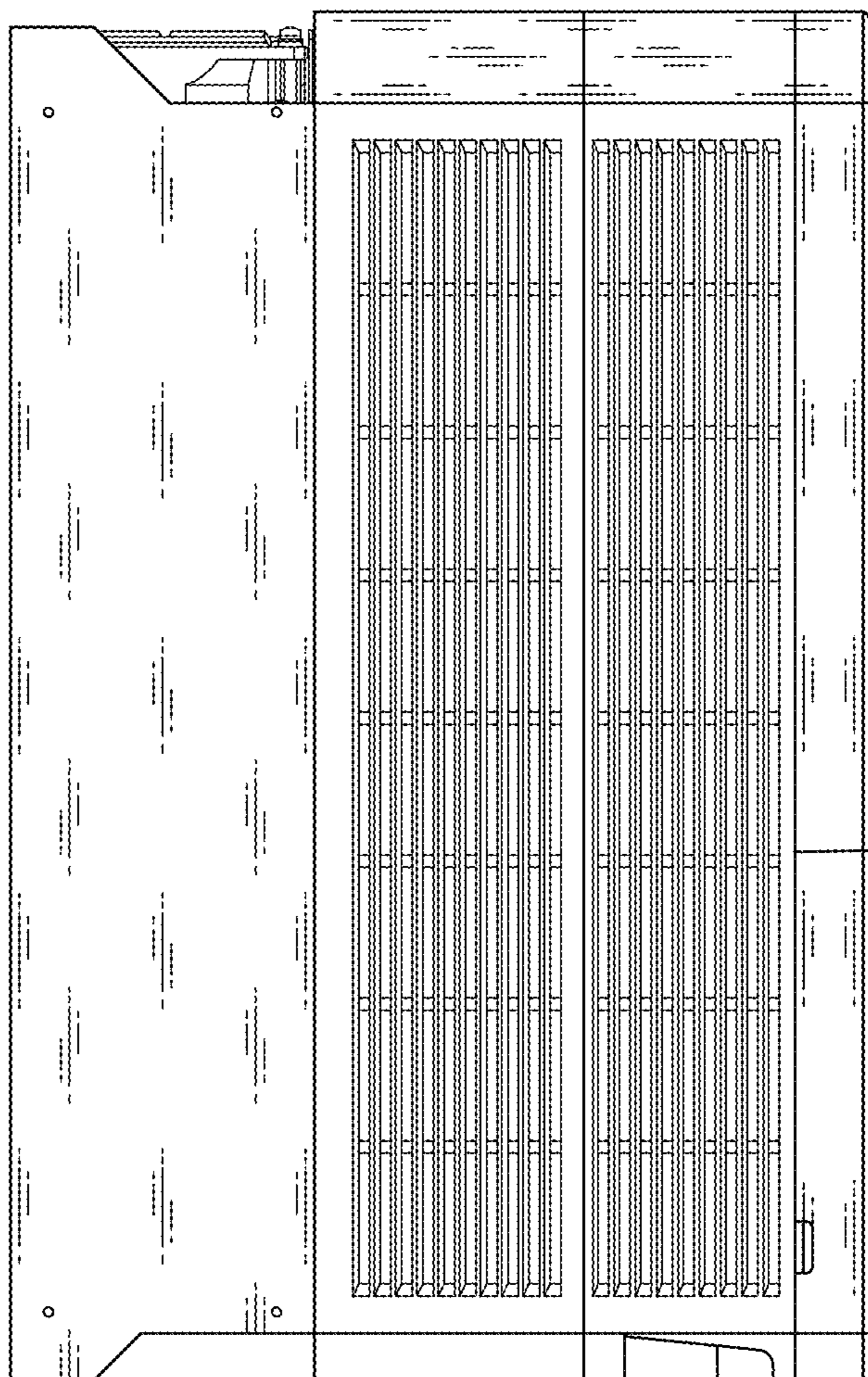

FIG. 5

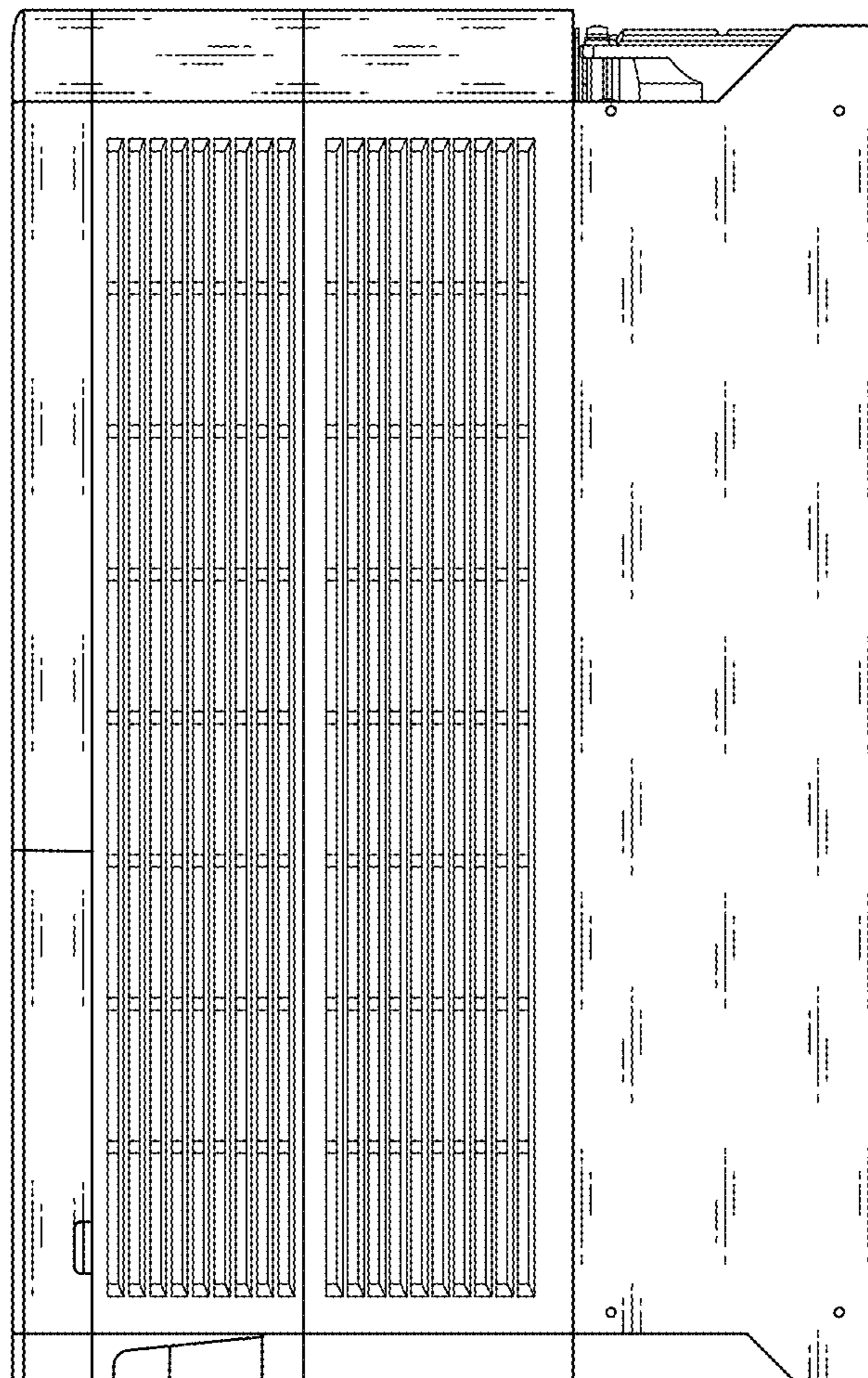

FIG. 6

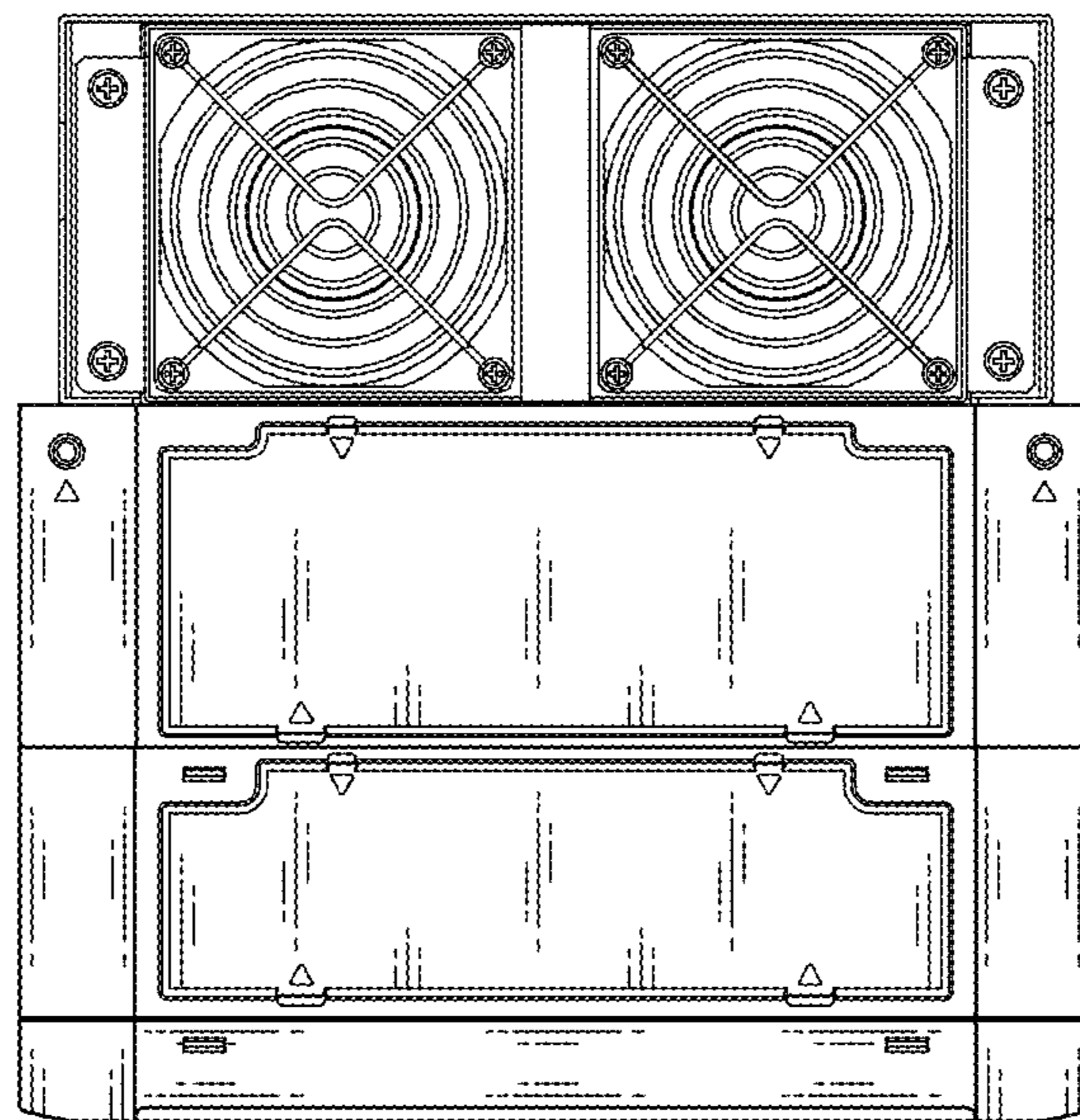

FIG. 7

