



US00D705569S

(12) **United States Design Patent**
Milburn

(10) **Patent No.:** **US D705,569 S**

(45) **Date of Patent:** **** May 27, 2014**

(54) **PAPER ROLL DISPENSER**

(76) Inventor: **Ms'd Albany Milburn**, Twinsburg, OH
(US)

(**) Term: **14 Years**

(21) Appl. No.: **29/431,105**

(22) Filed: **Sep. 4, 2012**

(51) **LOC (10) Cl.** **20-02**

(52) **U.S. Cl.**
USPC **D6/518**

(58) **Field of Classification Search**
USPC D6/515, 518-523; D3/201; 206/389,
206/391, 407, 409; 312/34.1, 34.8; 211/16,
211/85.5, 59.2; 221/92, 97, 185, 282, 284;
242/159, 160.2, 550, 560, 590, 594,
242/59, 588, 598, 598.3, 598.65
See application file for complete search history.

(56) **References Cited**

U.S. PATENT DOCUMENTS

D415,379 S	10/1999	Tisdale	
D422,170 S	4/2000	Harris, Jr.	
D426,991 S *	6/2000	Kent, Jr.	D6/518
6,267,316 B1 *	7/2001	Cross	D6/522

D474,359 S *	5/2003	Bennett	D6/518
D474,360 S	5/2003	Yip	
D522,292 S	6/2006	Goodman et al.	
D554,402 S *	11/2007	Krueger	D6/518
D603,635 S *	11/2009	Krebs	D6/518
D633,317 S *	3/2011	Walters	D6/522
D639,096 S *	6/2011	Koziol	D6/518

* cited by examiner

Primary Examiner — Brian N Vinson

(74) *Attorney, Agent, or Firm* — Crossley Patent Law;
Micah C. Gunn

(57) **CLAIM**

The ornamental design for a paper roll dispenser, as shown and described.

DESCRIPTION

FIG. 1 is a top plan view of a paper roll dispenser, with a base and end piece separated for clarity, showing my new design, the opposite side being a mirror image of the shown; FIG. 2 is a left elevation view thereof; FIG. 3 is a right elevation view thereof; FIG. 4 is a front elevation view thereof, the opposite side being a mirror image of the shown; and, FIG. 5 is an isometric view thereof.

1 Claim, 4 Drawing Sheets

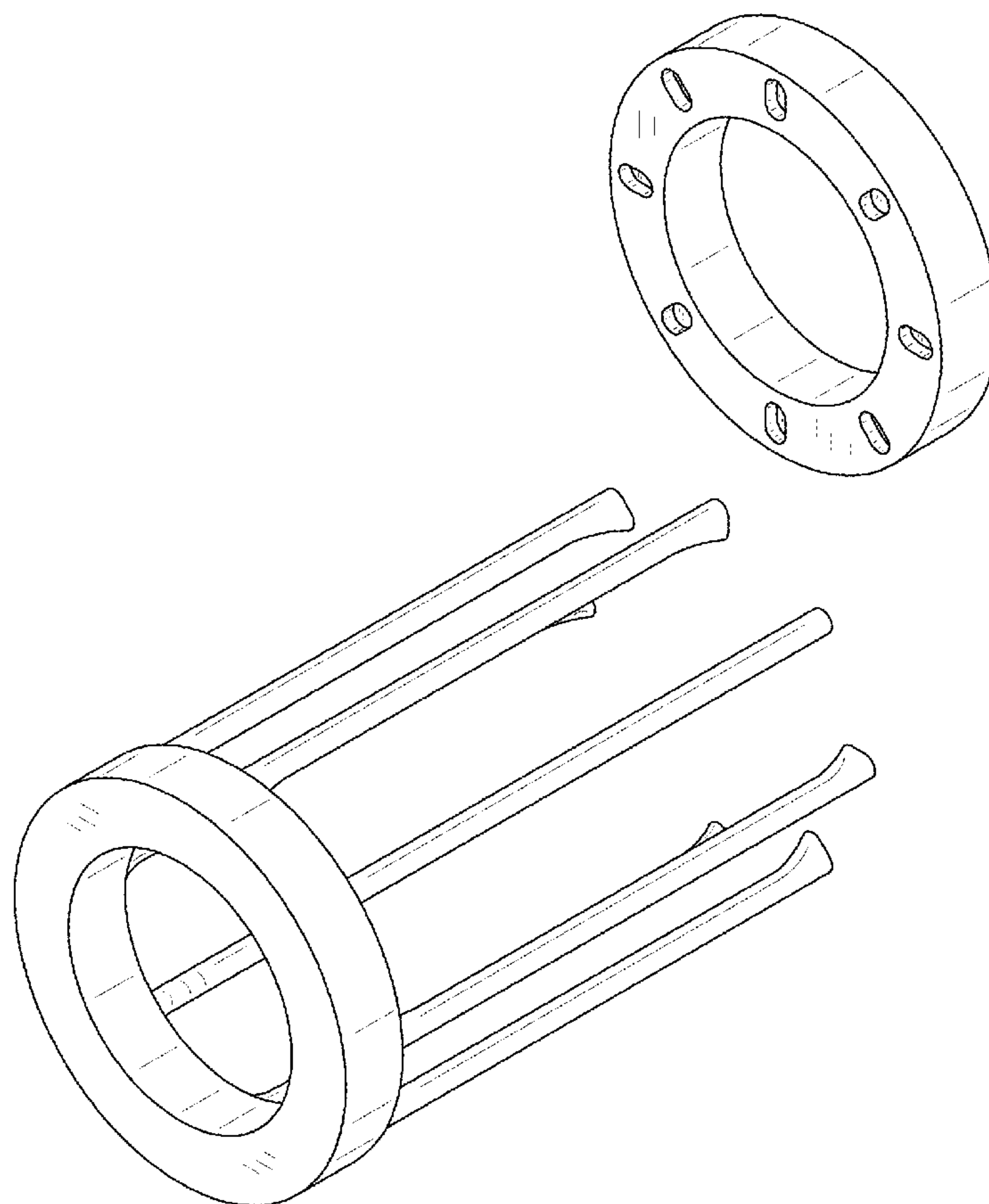

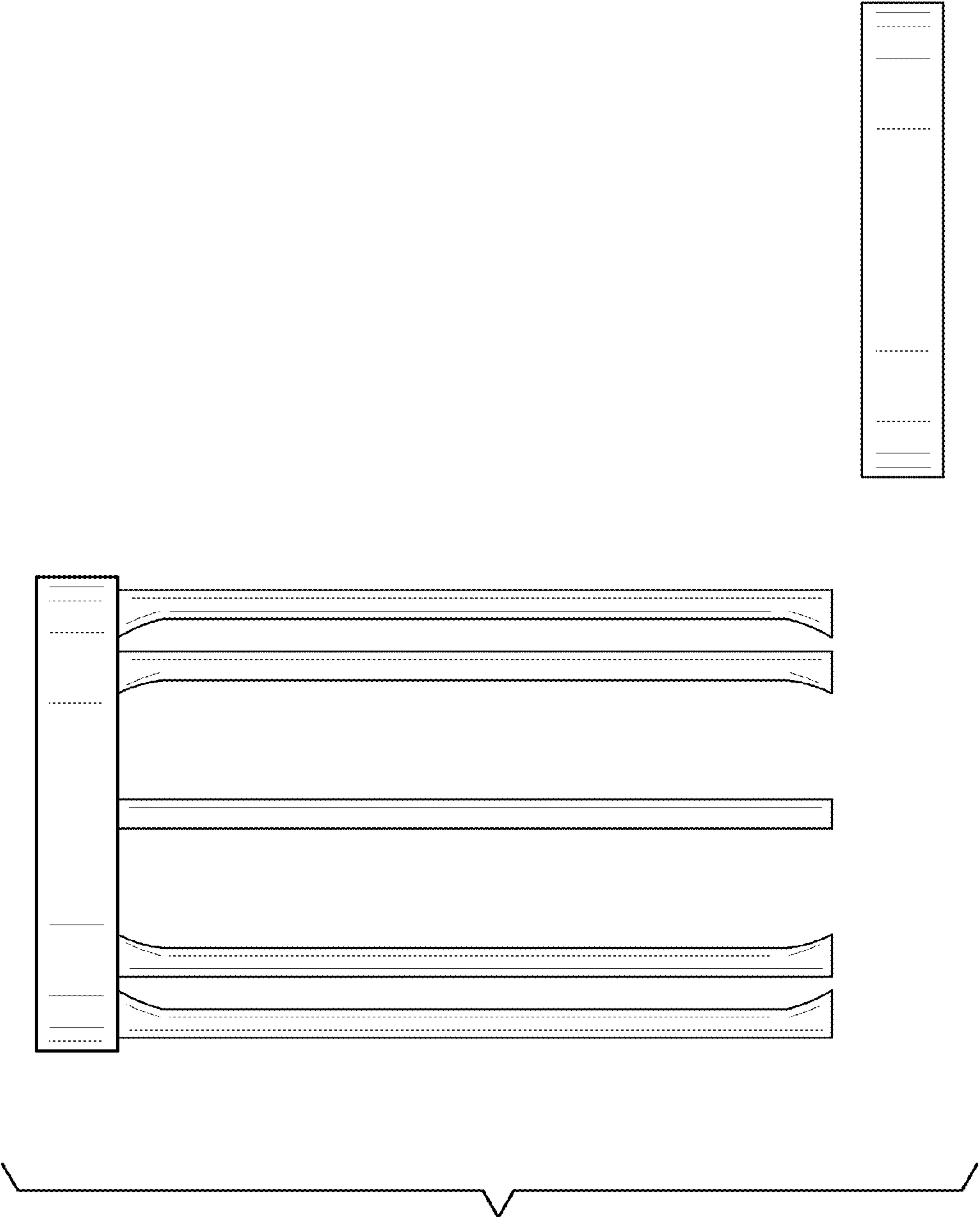

FIG. 1

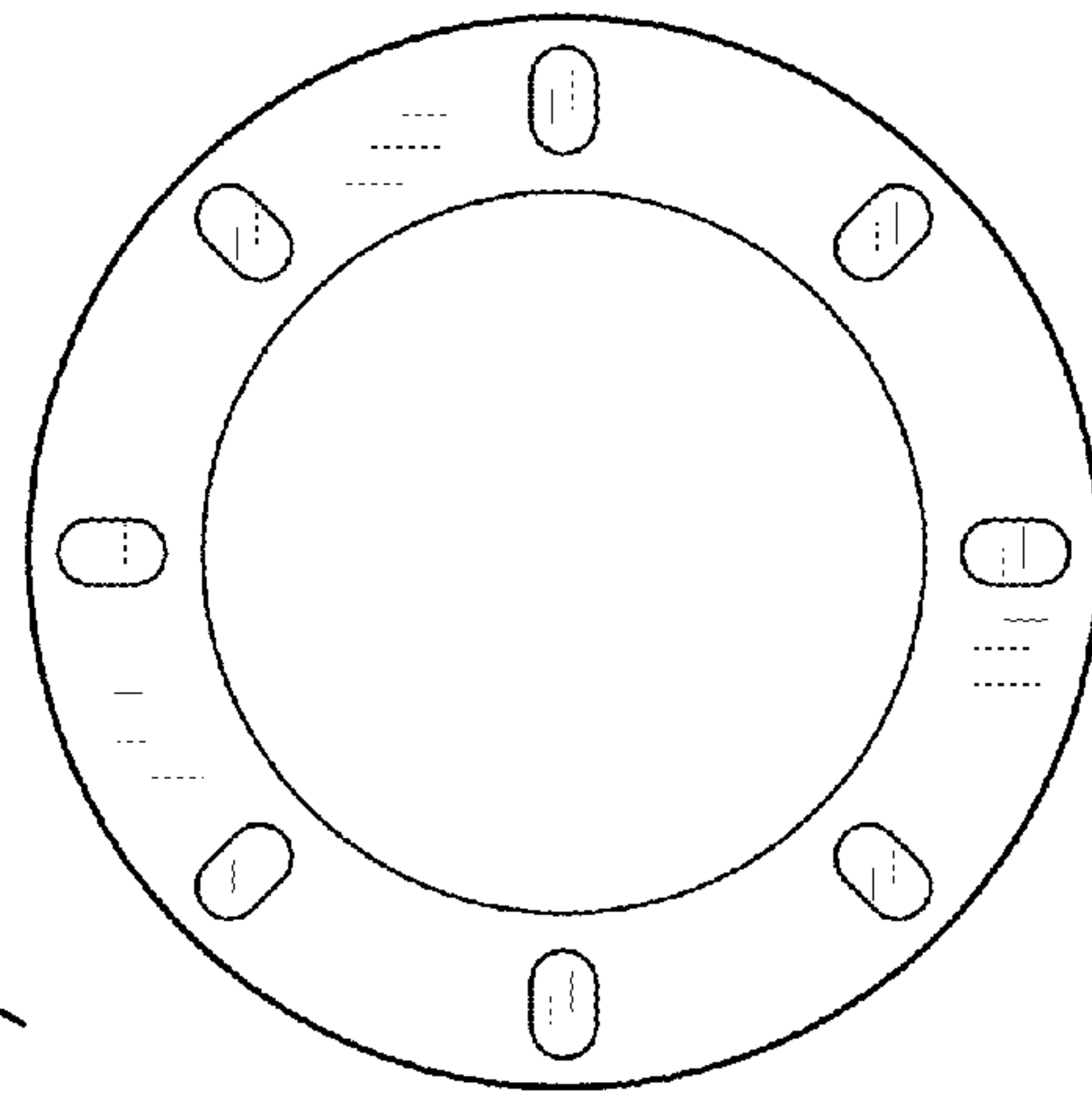
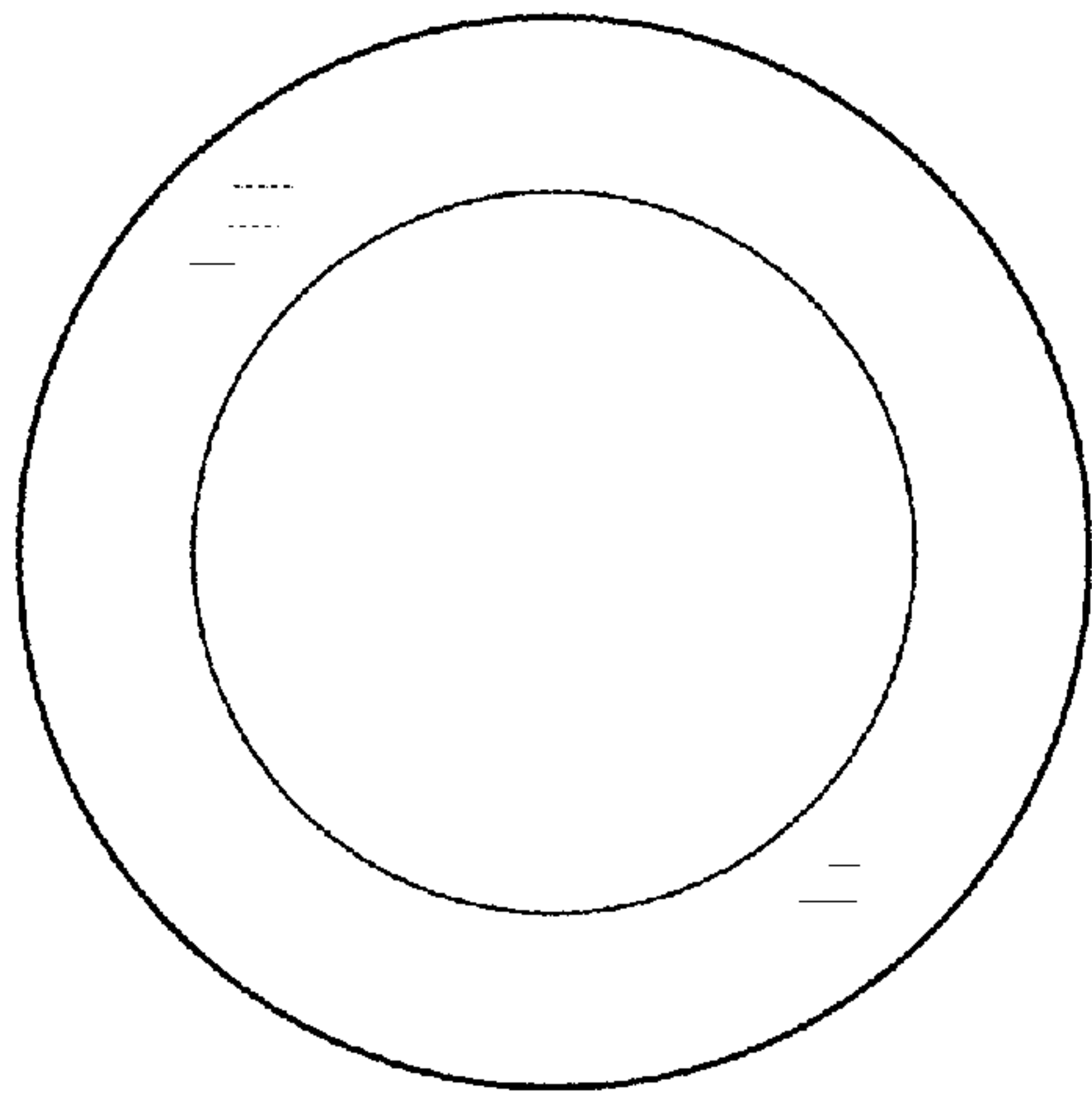
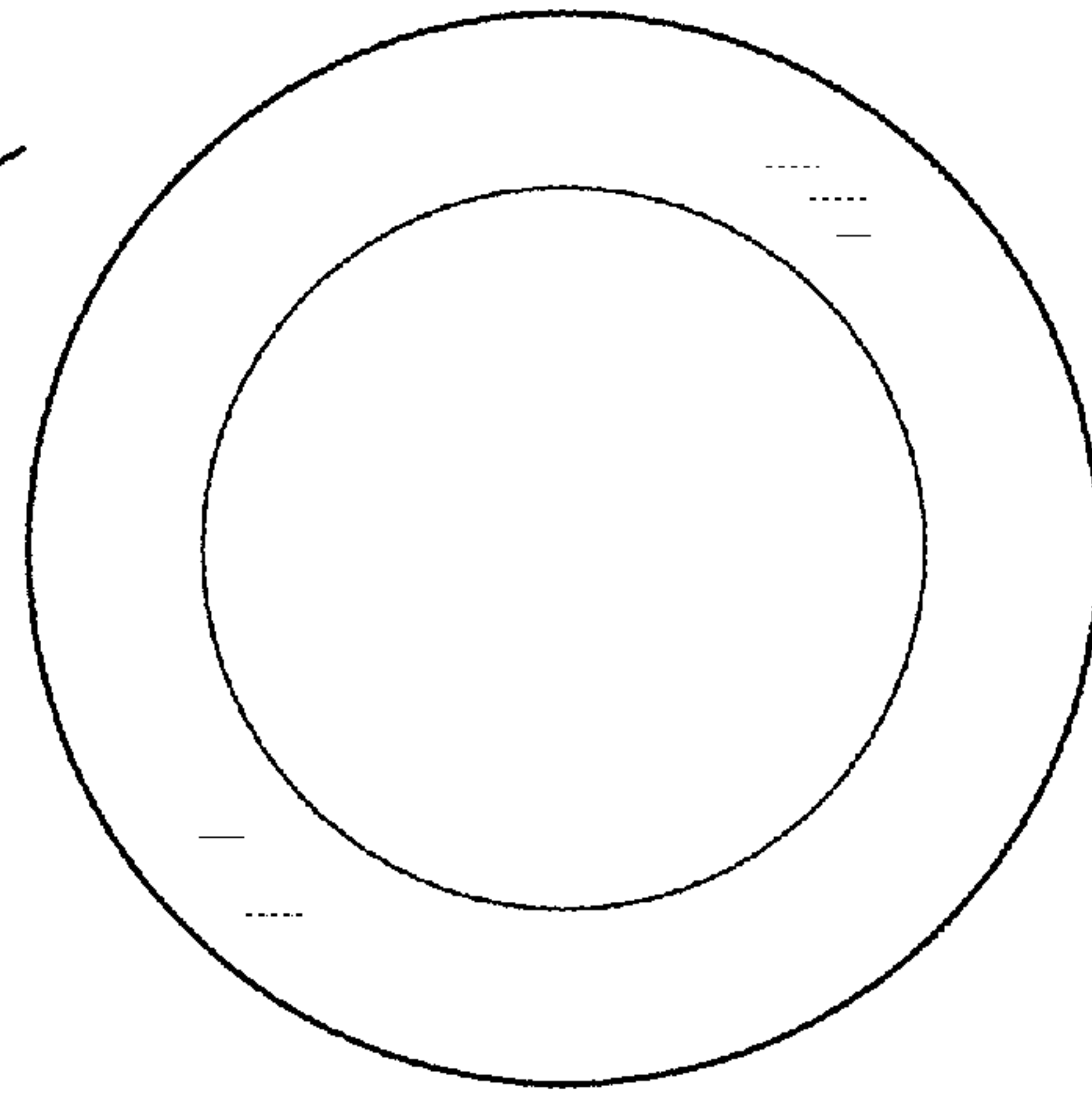
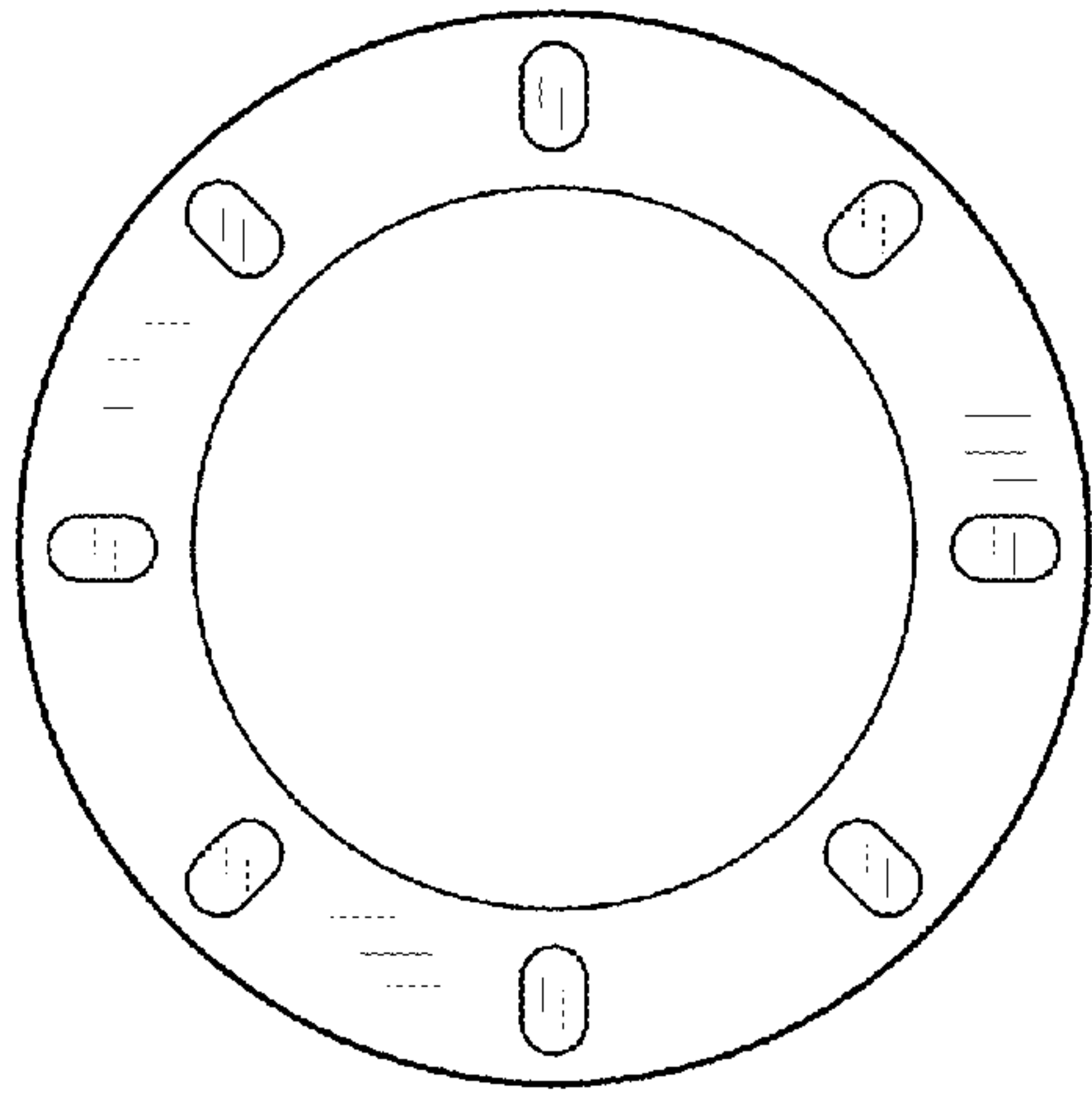

FIG. 2

FIG. 3

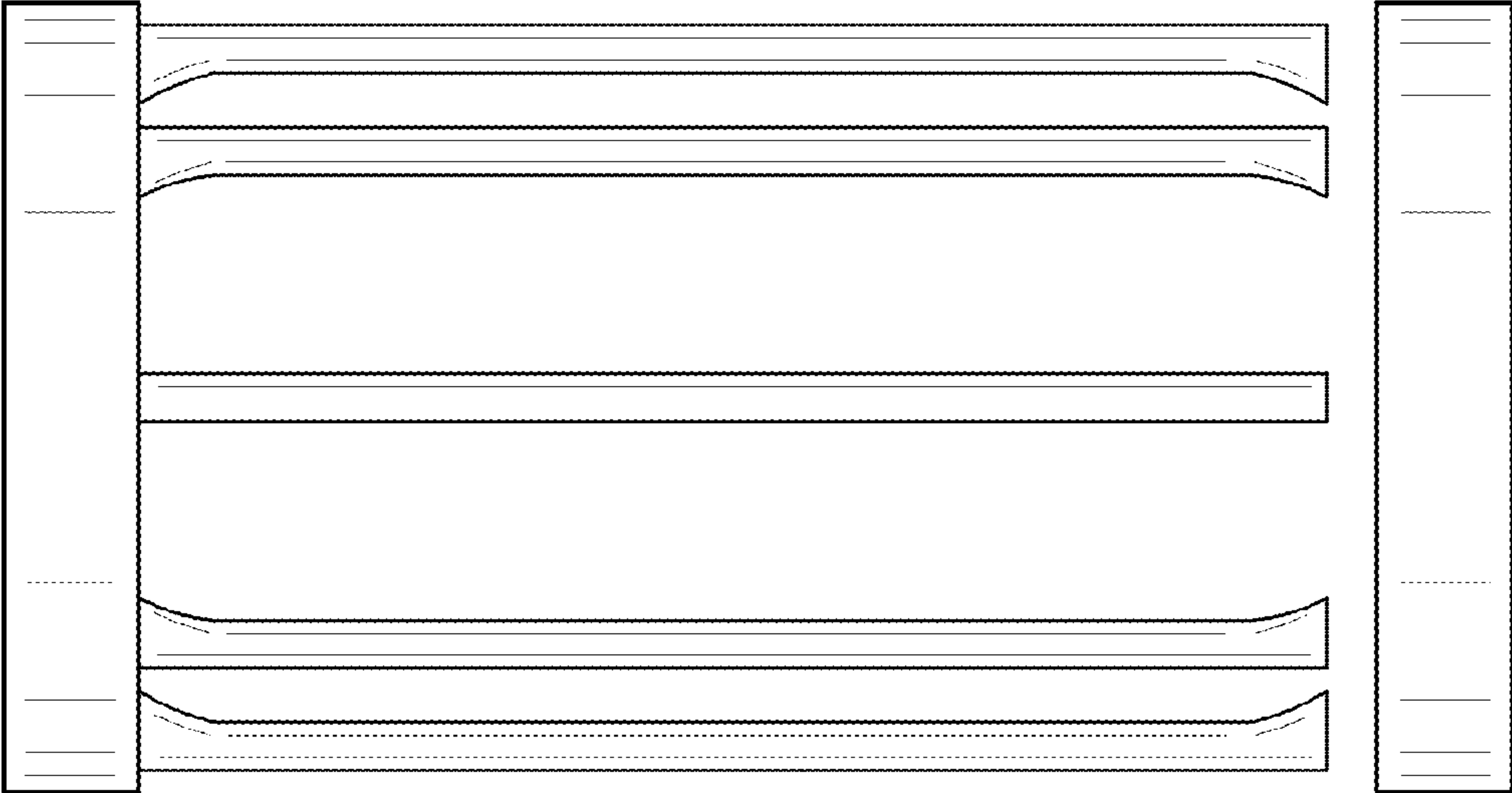

FIG. 4

