



US00D705554S

(12) **United States Design Patent**  
**Edwards**

(10) **Patent No.:** **US D705,554 S**

(45) **Date of Patent:** **\*\* May 27, 2014**

(54) **TOILET STOOL**

(71) Applicant: **Judy Edwards**, Saint George, UT (US)

(72) Inventor: **Judy Edwards**, Saint George, UT (US)

(\*\*) Term: **14 Years**

(21) Appl. No.: **29/456,331**

(22) Filed: **May 30, 2013**

(51) **LOC (10) Cl.** ..... **06-01**

(52) **U.S. Cl.**

USPC ..... **D6/349**

(58) **Field of Classification Search**

CPC ..... A47C 5/02; A47C 9/00; A47C 11/00;  
A47C 13/00; A47C 9/06; A47C 7/16

USPC ..... D6/330, 337, 341, 346, 349-355, 357,  
D6/362, 364-373, 376, 377, 381, 645, 656,  
D6/658, 665, 674, 675.5, 676, 685-692,  
D6/694, 704, 705, 707, 707.19, 708,  
D6/716.1-716.6, 717, 717.2; 297/423.12,  
297/423.13, 423.37, 461, 462, 115, 116,  
297/135, 160-162

See application file for complete search history.

(56) **References Cited**

**U.S. PATENT DOCUMENTS**

2,023,901	A	12/1935	Rhodes	
D157,319	S	* 2/1950	Bair	D6/349
2,834,028	A	5/1958	Stanley	
D192,218	S	2/1962	Forsman et al.	
D268,796	S	5/1983	Kola	
D271,256	S	* 11/1983	McClelland	D6/349
4,713,846	A	12/1987	Hodroski	
D297,789	S	9/1988	Stepien	
D309,680	S	8/1990	Gusty	
5,028,024	A	7/1991	Welles	
D337,211	S	* 7/1993	Bergkvist	D6/349
D346,704	S	* 5/1994	Grosfillex	D6/349

D398,678	S	9/1998	Terry et al.	
D402,045	S	12/1998	Lougee	
D407,569	S	* 4/1999	Underbrink et al.	D6/349
D435,993	S	1/2001	Johnson	
D508,556	S	8/2005	Palazzolo	
D508,559	S	8/2005	Spiegel et al.	
D509,289	S	9/2005	Palazzolo	
D524,562	S	7/2006	Franciosia	
D538,557	S	3/2007	Martyn	
D553,370	S	10/2007	Meyers et al.	
D557,910	S	* 12/2007	Saunders et al.	D6/350
D561,482	S	* 2/2008	Rogers	D6/349
D582,168	S	12/2008	Sandel	
D606,768	S	12/2009	Tu	
D629,222	S	12/2010	Kay	
D629,627	S	12/2010	Mylet	
D632,101	S	* 2/2011	Sandel et al.	D6/349
D690,522	S	* 10/2013	Pontiff	D6/349

\* cited by examiner

*Primary Examiner* — Susan Bennett Hattan

*Assistant Examiner* — Vy Koenig

(74) *Attorney, Agent, or Firm* — QuickPatents; Kevin Prince

(57) **CLAIM**

I claim the ornamental design for a toilet stool, as shown and described.

**DESCRIPTION**

FIG. 1 is a top rear perspective view of a toilet stool, showing my new design;

FIG. 2 is a front elevational view thereof;

FIG. 3 is a rear elevational view thereof;

FIG. 4 is a right-side elevational view thereof, the left-side elevational view being a mirror image thereof;

FIG. 5 is a top plan view thereof;

FIG. 6 is a bottom plan view thereof;

FIG. 7 is a bottom perspective view thereof; and,

FIG. 8 is a cross-sectional view thereof, taken along line 8-8 of FIG. 3.

**1 Claim, 6 Drawing Sheets**

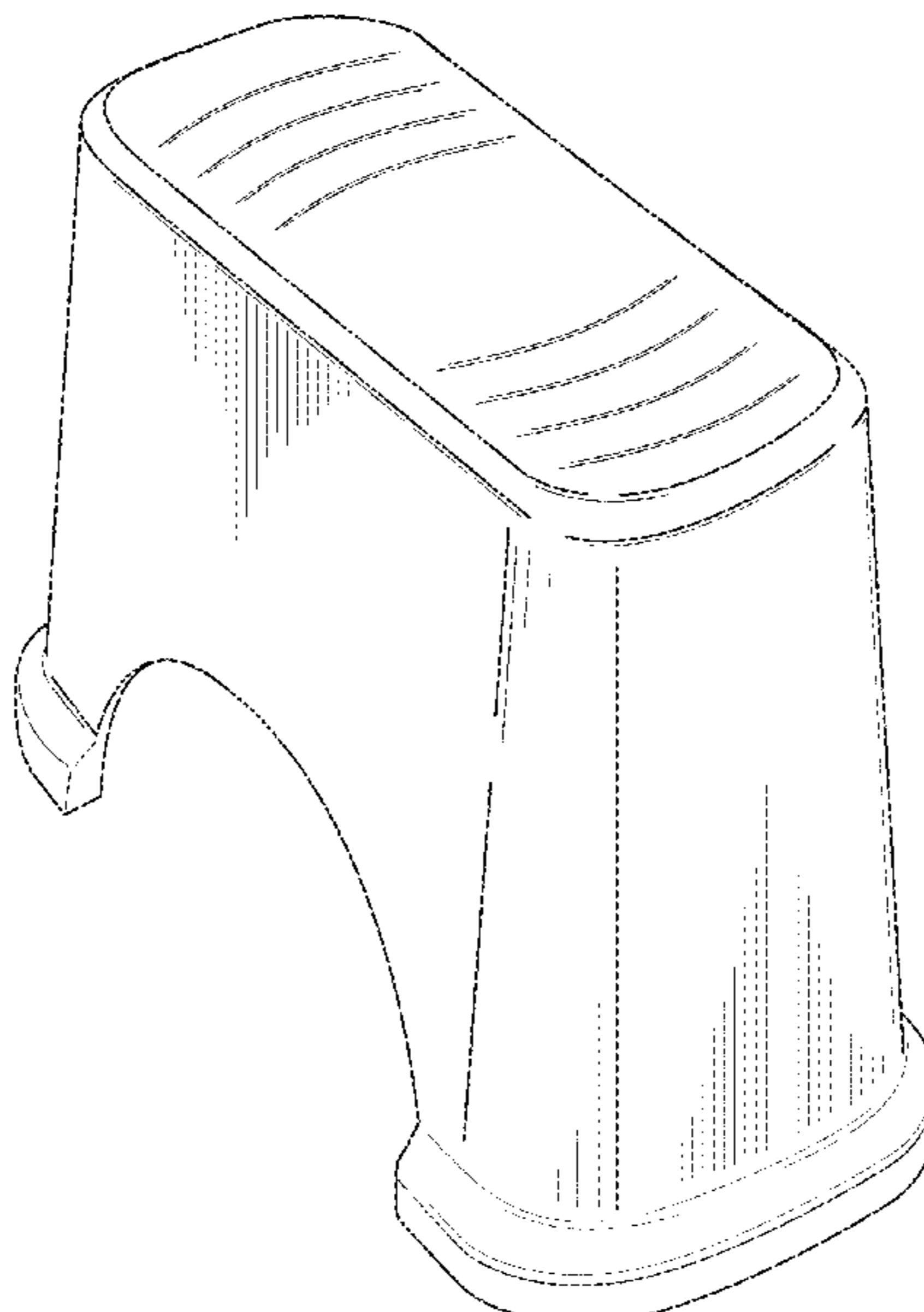

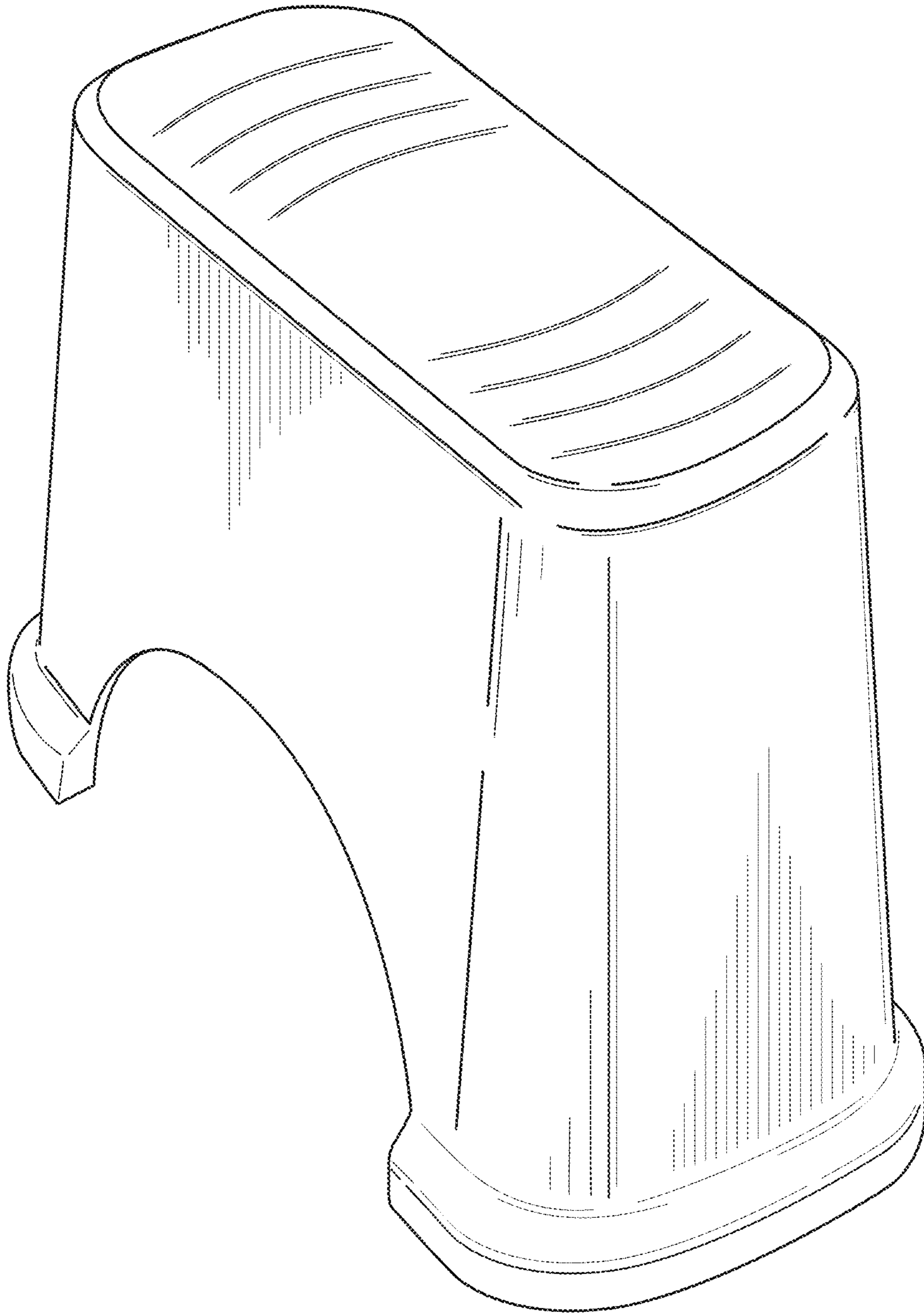

FIG. 1

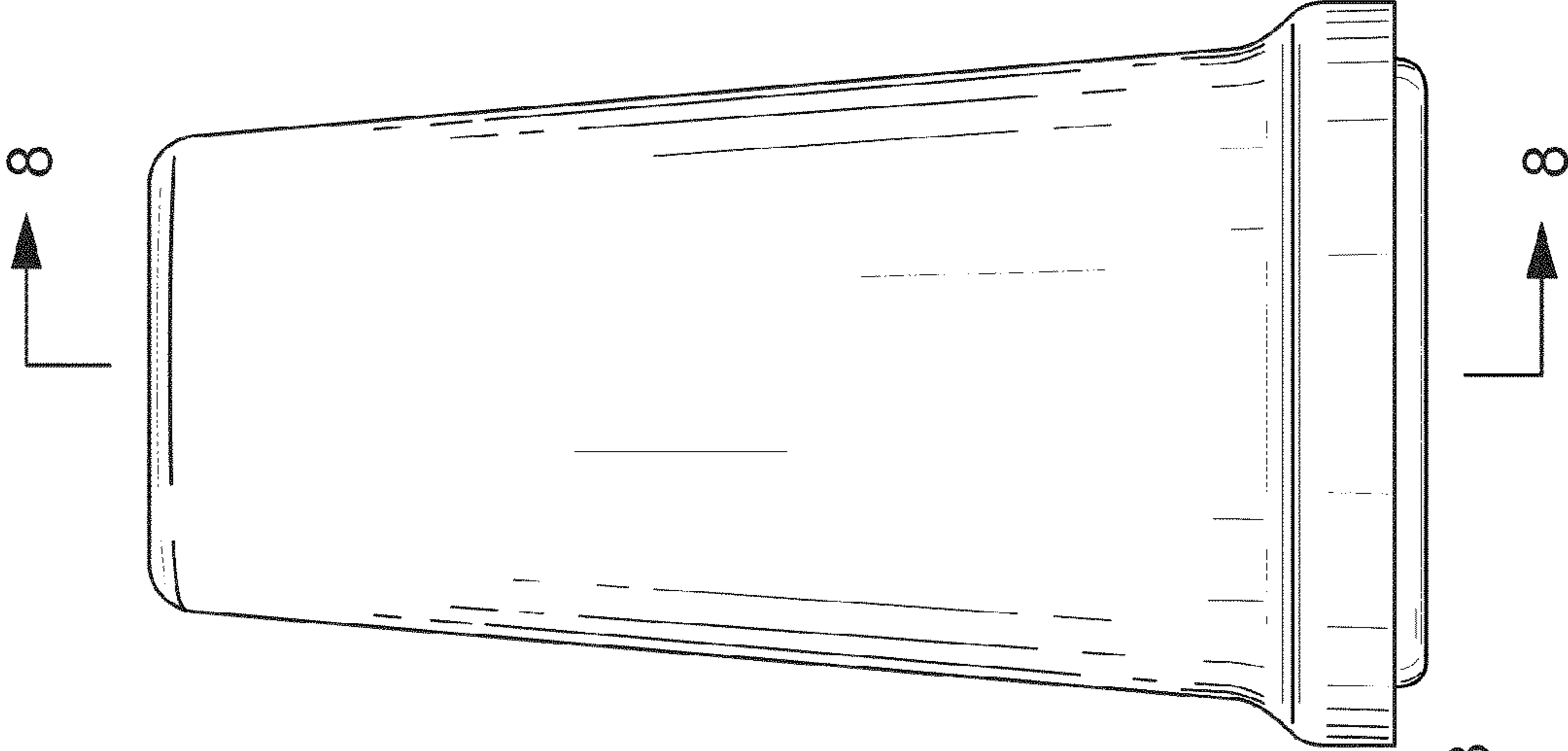

FIG. 3

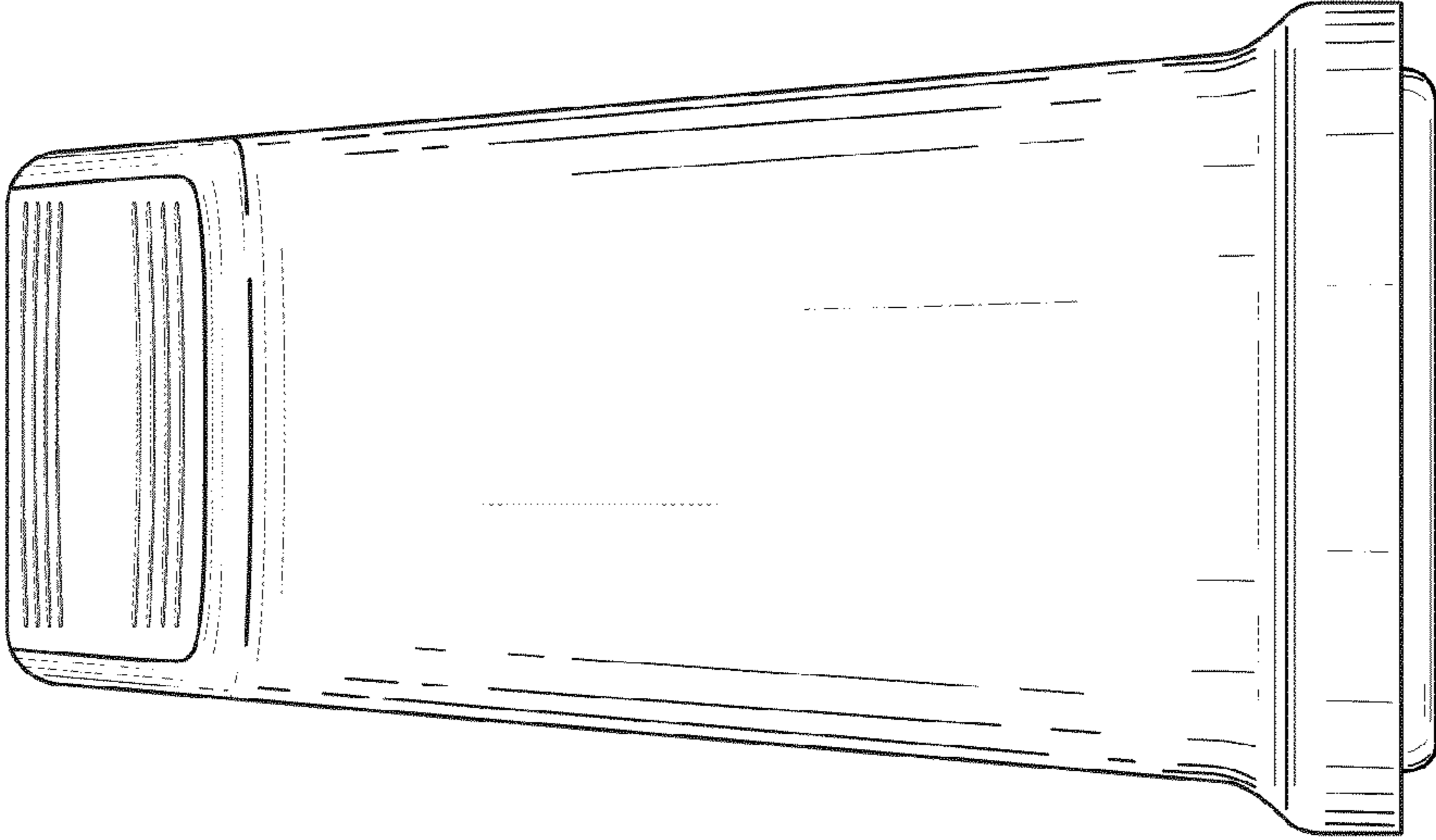

FIG. 2

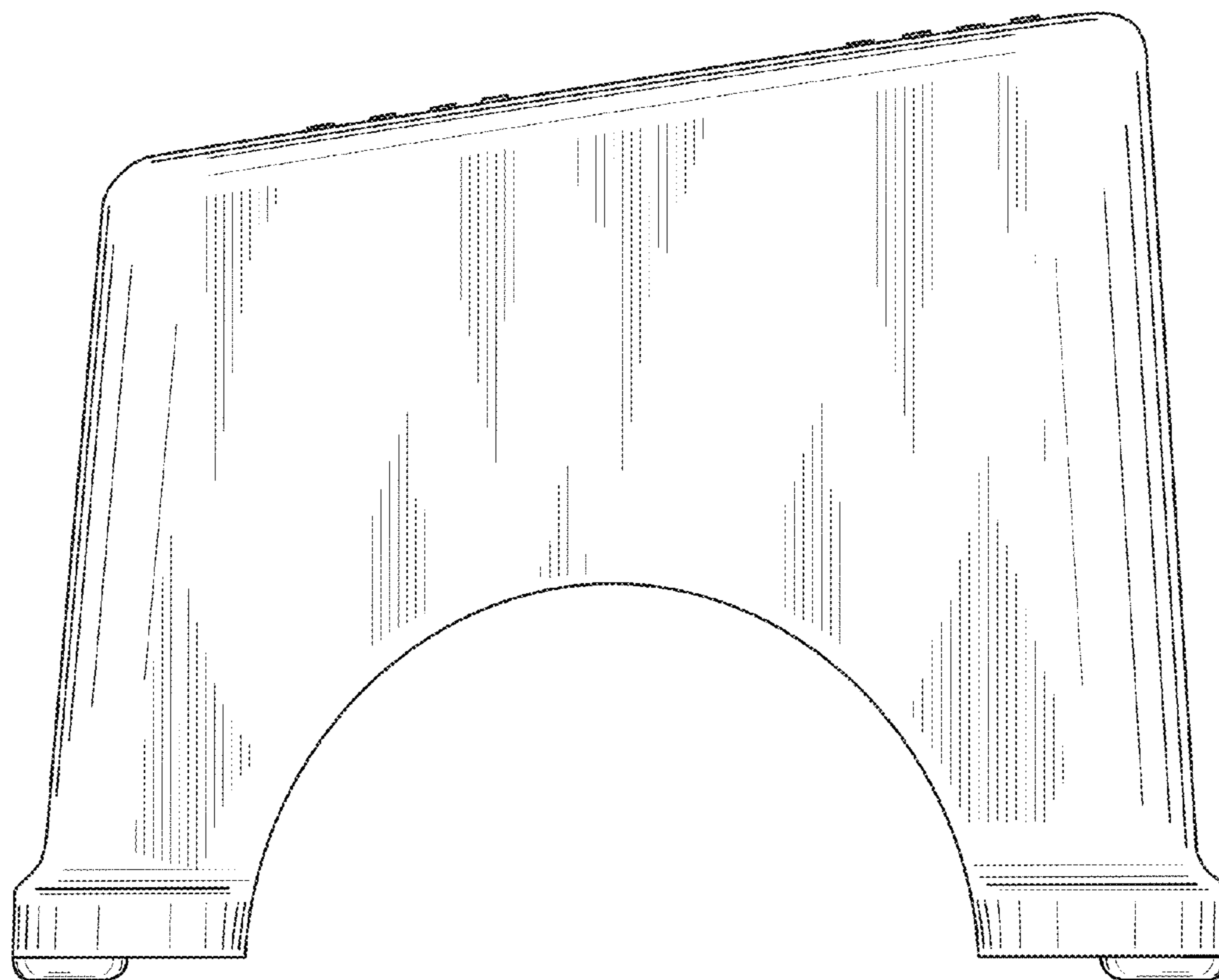

FIG. 4

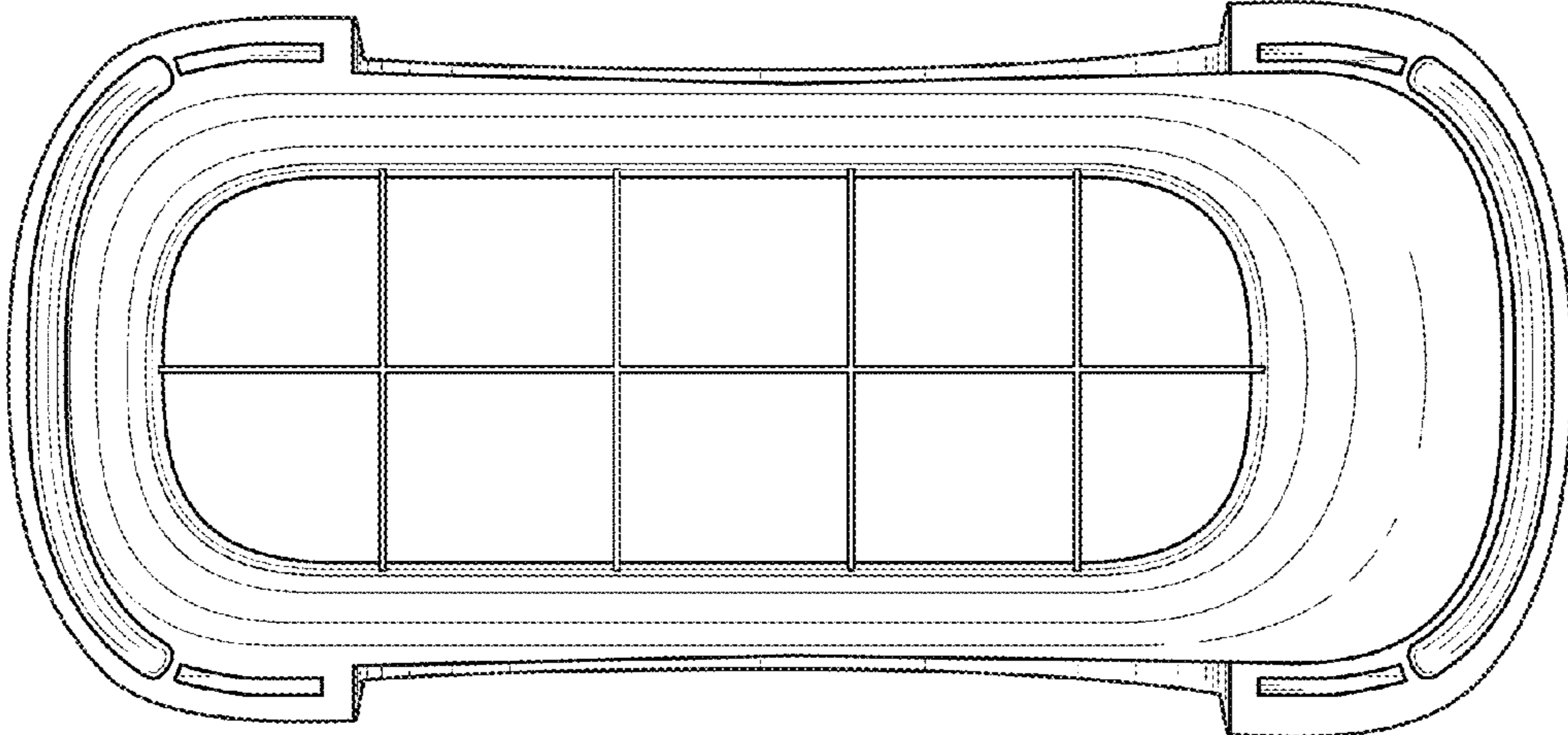

FIG. 6

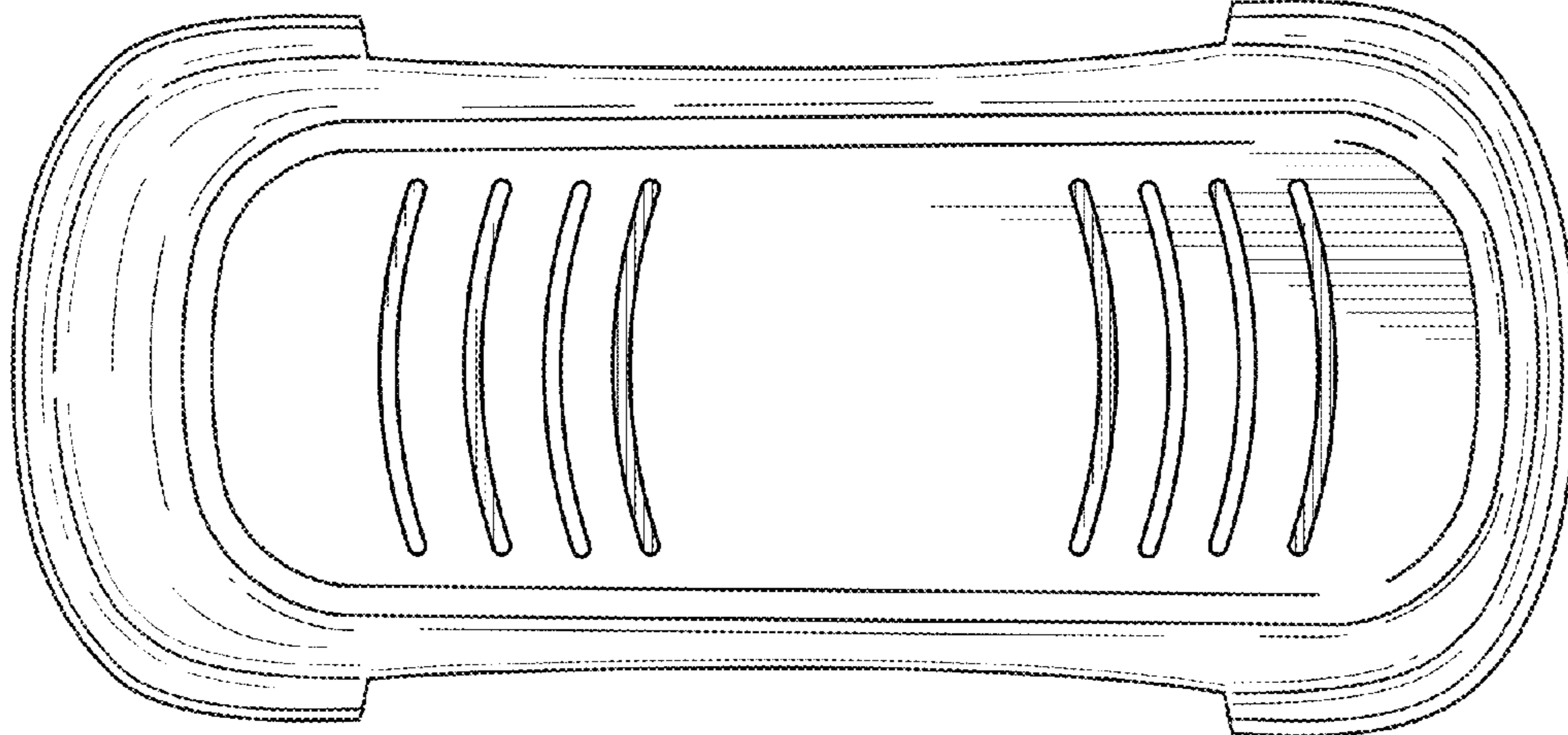

FIG. 5

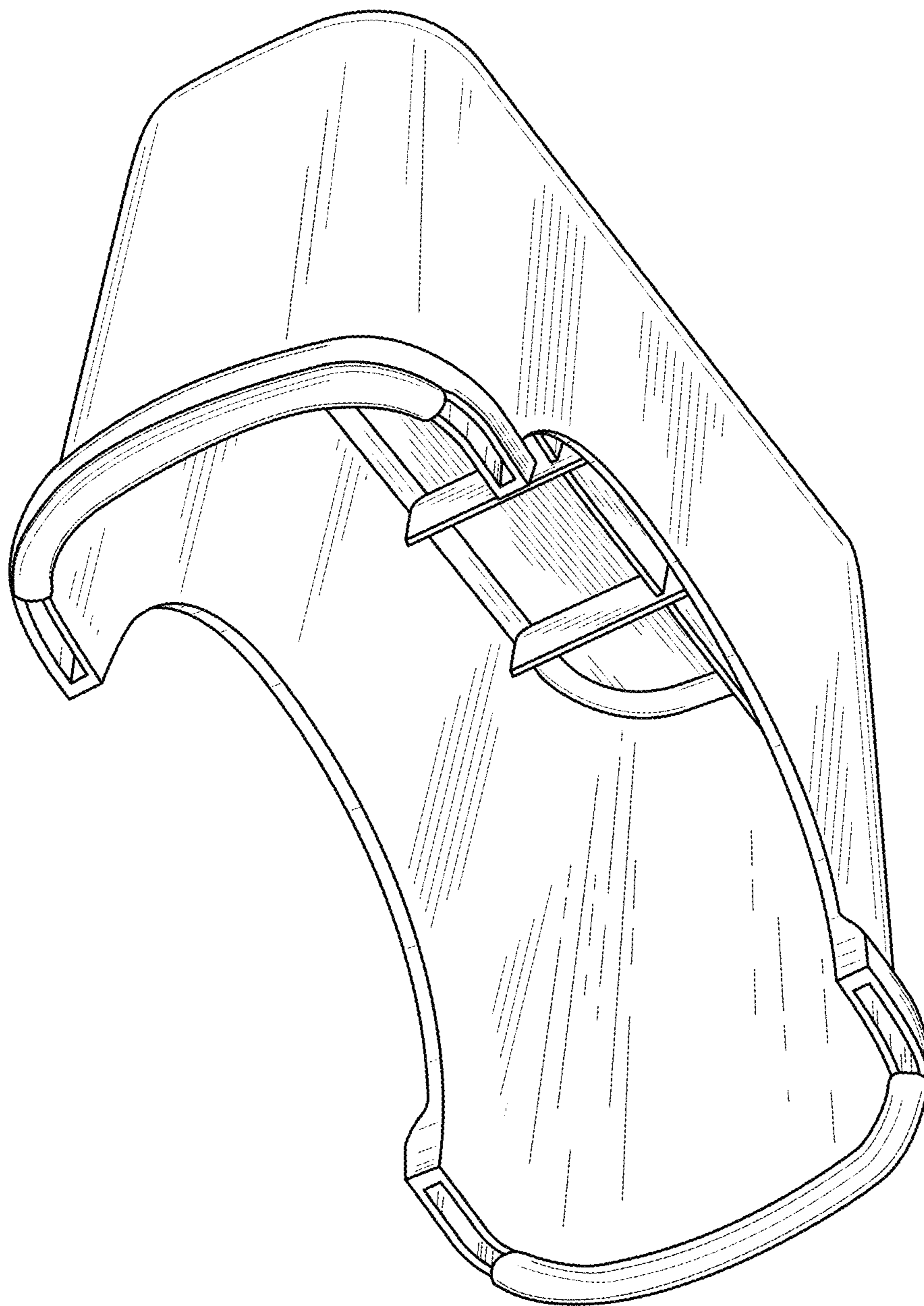

FIG. 7

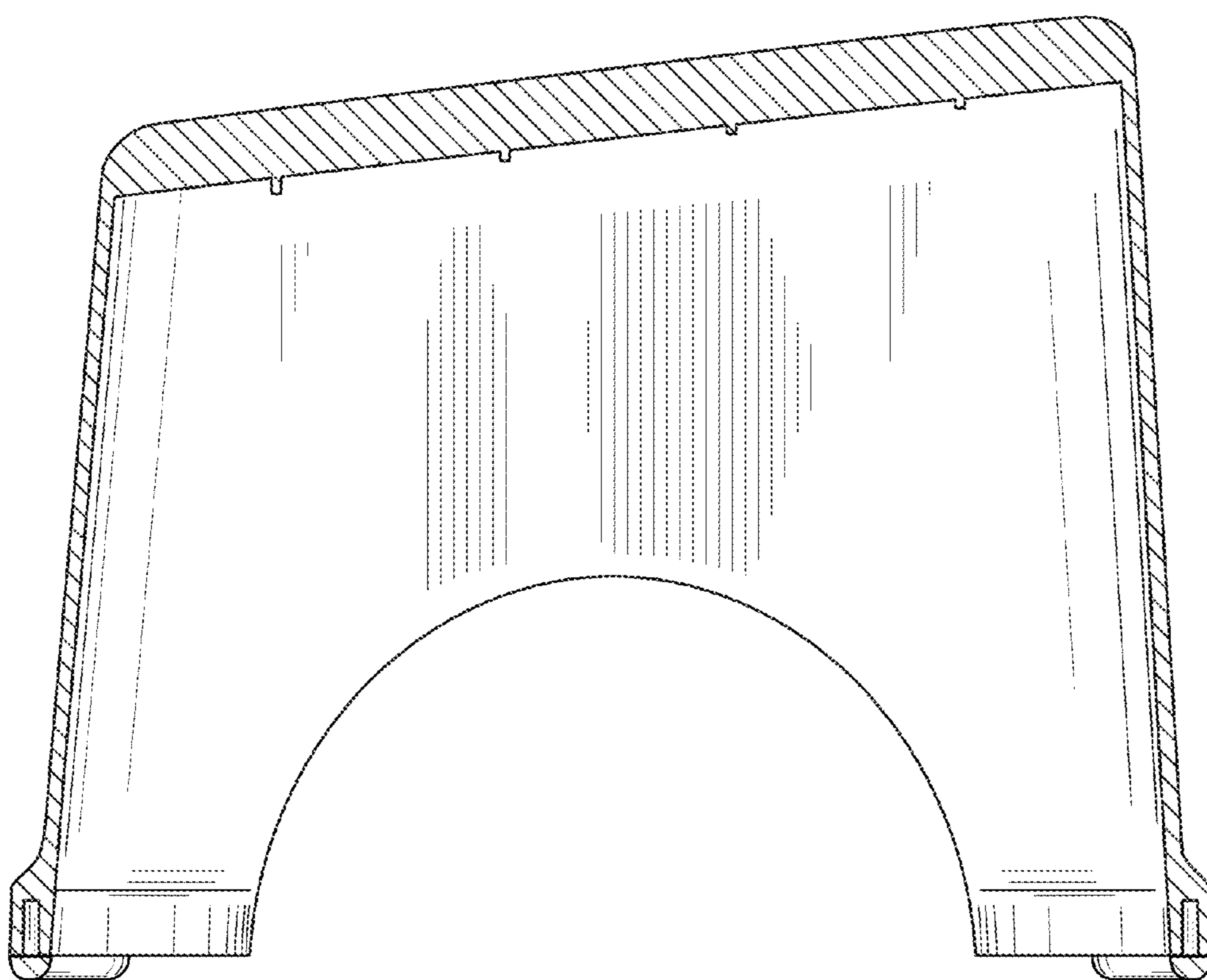

FIG. 8