



US00D705535S

(12) **United States Design Patent**  
**Stapleton**

(10) **Patent No.:** **US D705,535 S**

(45) **Date of Patent:** **\*\* May 27, 2014**

(54) **MOBILE PHONE CARRIER ATTACHABLE TO FOOTWEAR**

(71) Applicant: **Tony A. Stapleton**, Snohomish, WA (US)

(72) Inventor: **Tony A. Stapleton**, Snohomish, WA (US)

(\*\*) Term: **14 Years**

(21) Appl. No.: **29/463,054**

(22) Filed: **Jul. 11, 2013**

(51) **LOC (10) Cl.** ..... **03-01**

(52) **U.S. Cl.**  
USPC ..... **D3/218; D2/946**

(58) **Field of Classification Search**  
USPC ..... D3/218, 215, 224, 226, 228; D2/946, D2/905; 36/136, 1, 114; 40/636  
See application file for complete search history.

(56) **References Cited**

U.S. PATENT DOCUMENTS

3,018,570	A	1/1962	Bliese	
4,507,882	A	4/1985	Harrell	
4,536,975	A	8/1985	Harrell	
4,630,383	A	12/1986	Gamm	
4,638,579	A	1/1987	Gamm	
4,823,426	A	4/1989	Bragga	
4,897,947	A	2/1990	Kass-Pious	
5,094,016	A	3/1992	DiVito	
5,311,679	A	5/1994	Birch, Sr.	
D369,458	S	5/1996	Adams	
5,596,821	A	1/1997	Solo	
6,449,881	B1	9/2002	Assaf et al.	
6,684,543	B2	2/2004	Fernau	
D507,861	S	8/2005	Kim	
D554,365	S *	11/2007	Zhou	D3/218
D643,619	S *	8/2011	Littleton	D3/215
D659,384	S *	5/2012	January	D3/218

D667,630	S	9/2012	Christ	
D697,709	S *	1/2014	Klusener	D3/218
2003/0126768	A1	7/2003	Hutt	
2004/0159022	A1	8/2004	Winford et al.	
2008/0229621	A1	9/2008	Simon et al.	

\* cited by examiner

*Primary Examiner* — Catheri Oliver-Garcia

(74) *Attorney, Agent, or Firm* — Todd N. Hathaway

(57) **CLAIM**

The ornamental design for a mobile phone carrier attachable to footwear, as shown and described.

**DESCRIPTION**

FIG. 1 is a top plan view of a mobile phone carrier attachable to footwear showing my new design, the mobile phone carrier being shown in a closed configuration;

FIG. 2 is an environmental top plan view thereof, illustrating the mobile phone carrier attached to an article of footwear;

FIG. 3 is a left side elevational view thereof;

FIG. 4 is an environmental left side elevational view thereof, illustrating the mobile phone carrier attached to an article of footwear;

FIG. 5 is a right side elevational view thereof;

FIG. 6 is a bottom plan view thereof;

FIG. 7 is a rear end elevational view thereof;

FIG. 8 is a front end elevational view thereof;

FIG. 9 is a second top plan view of the mobile phone carrier attachable to footwear of FIG. 1, the mobile phone carrier being shown in an opened configuration;

FIG. 10 is a left side elevational view thereof;

FIG. 11 is a right side elevational view thereof;

FIG. 12 is a bottom plan view thereof;

FIG. 13 is a rear end elevational view thereof; and,

FIG. 14 is a front end elevational view thereof.

The broken lines are for illustrative purposes only and form no part of the claimed design.

**1 Claim, 10 Drawing Sheets**

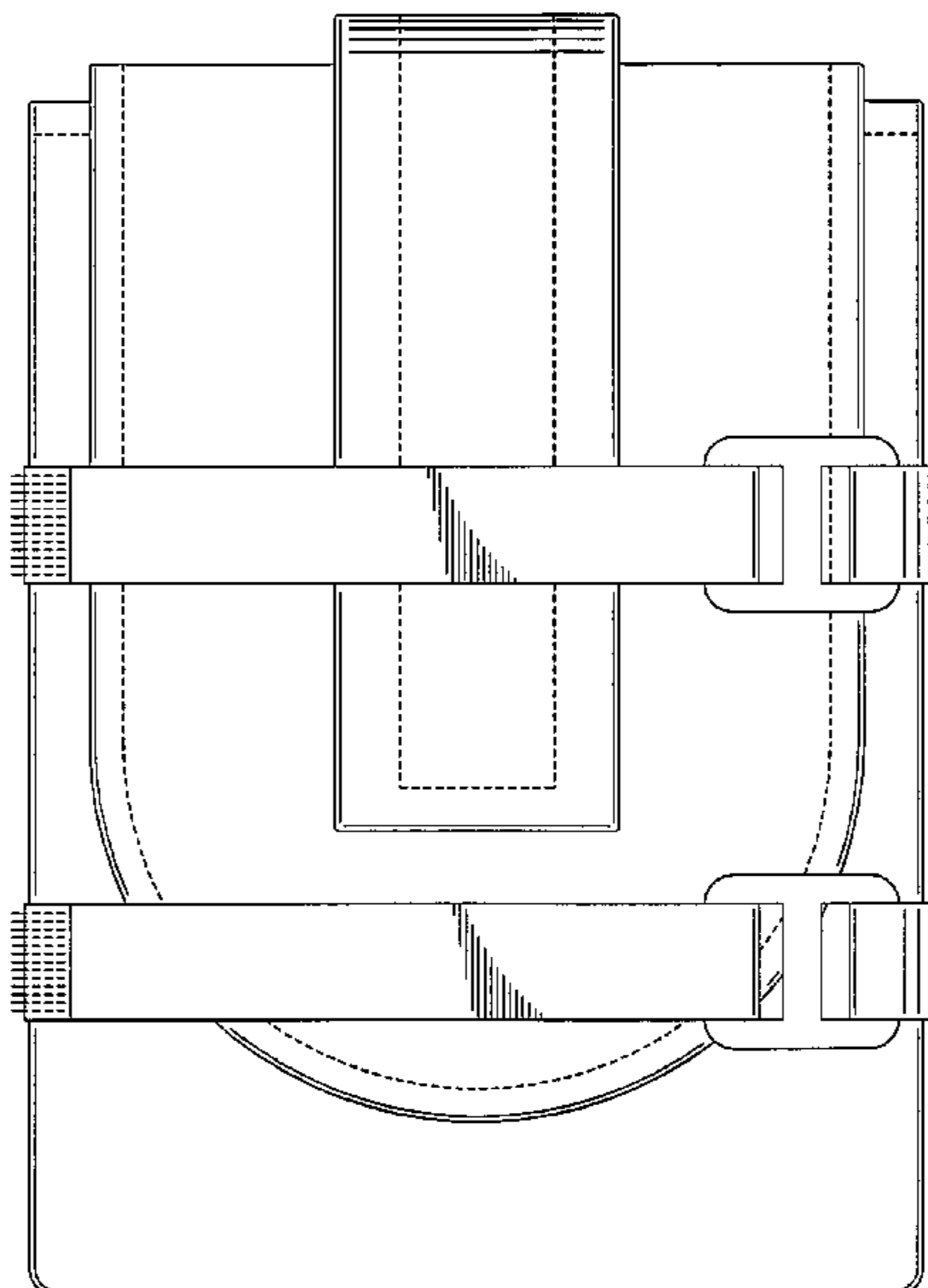

FIG. 1

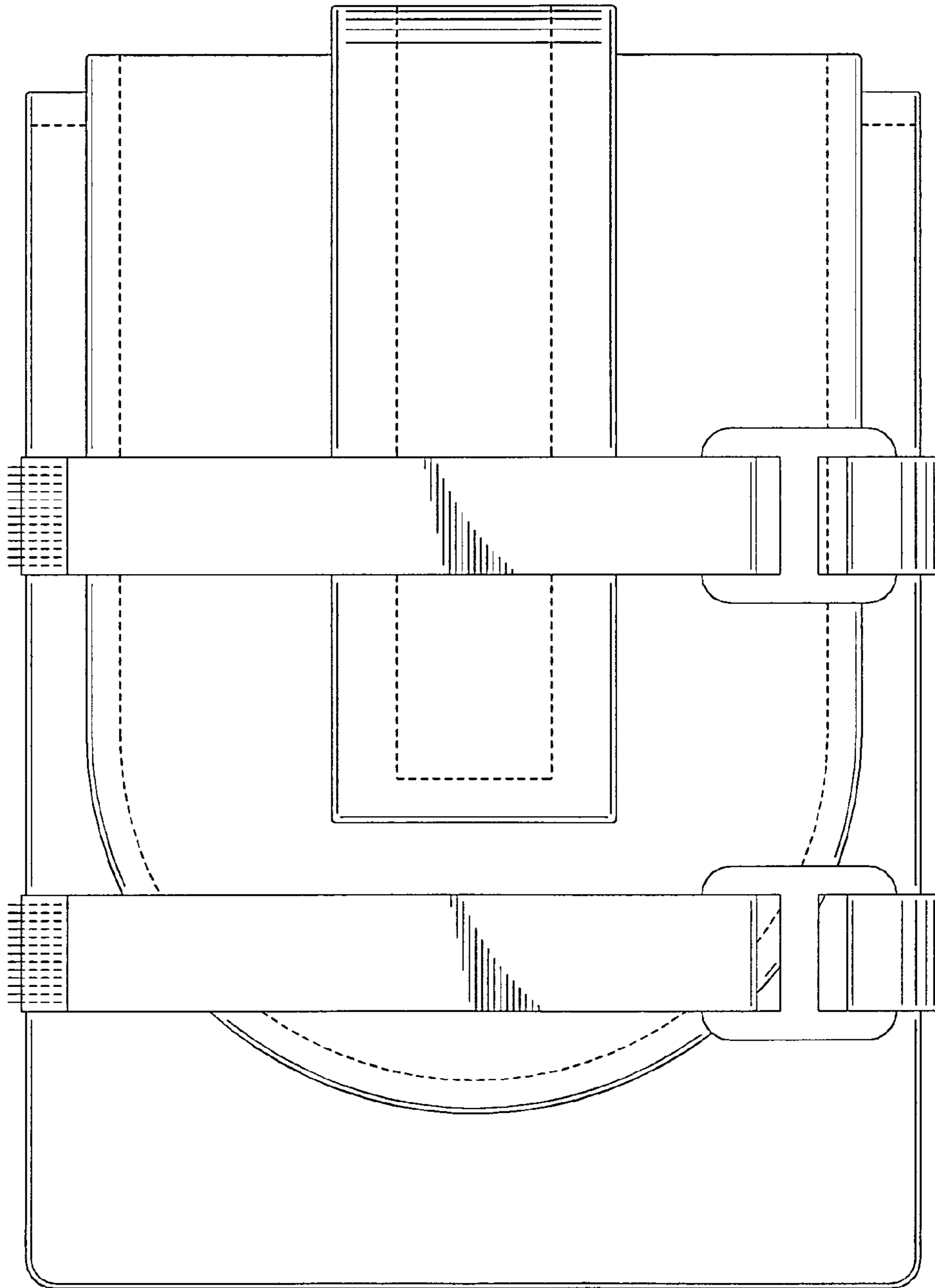

FIG. 2

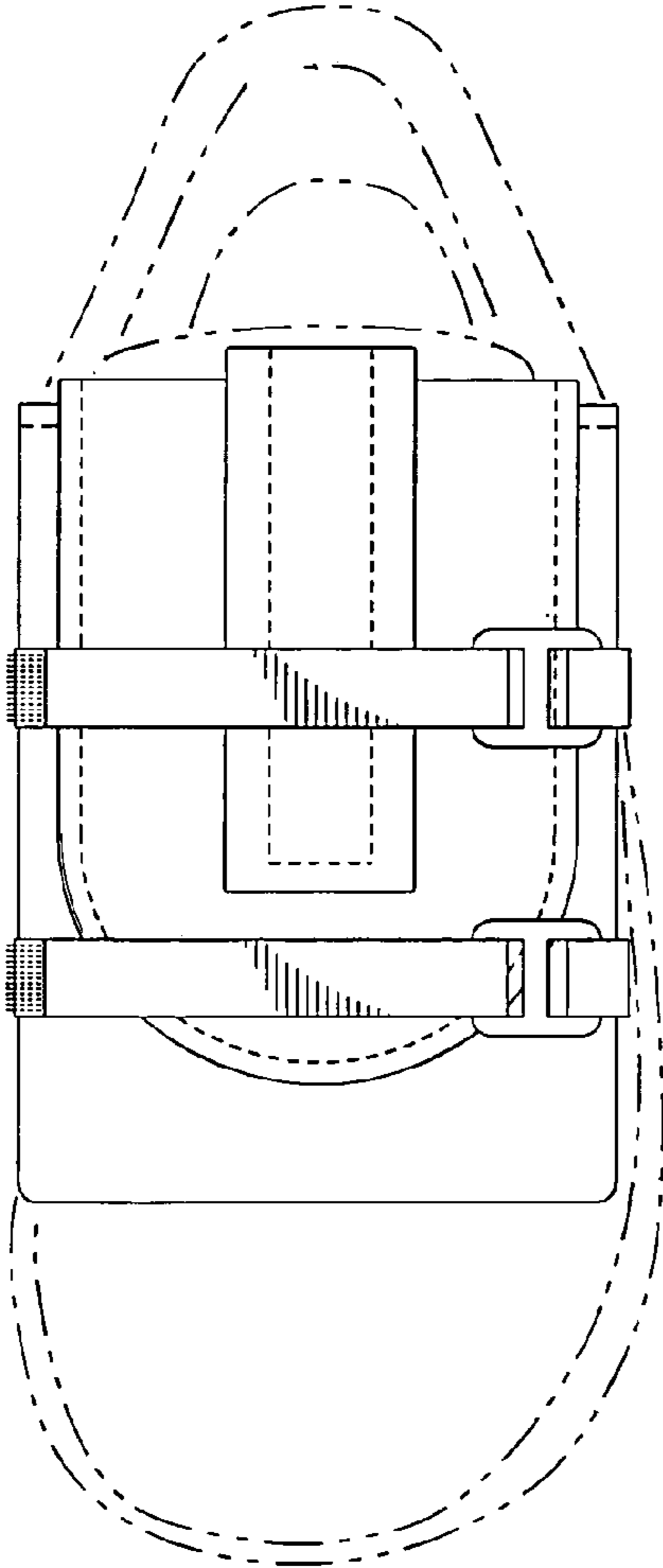

FIG. 3

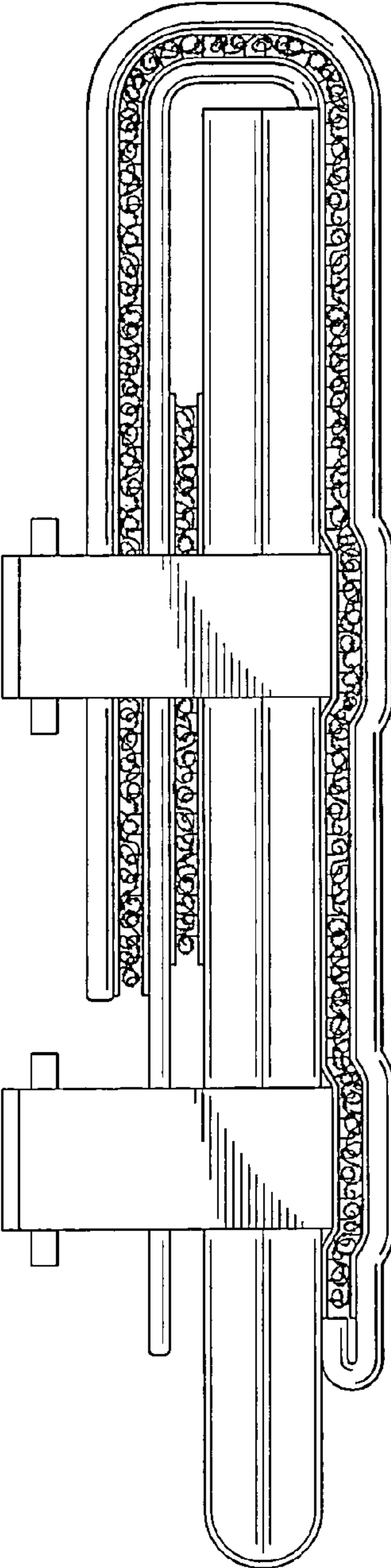

FIG. 4

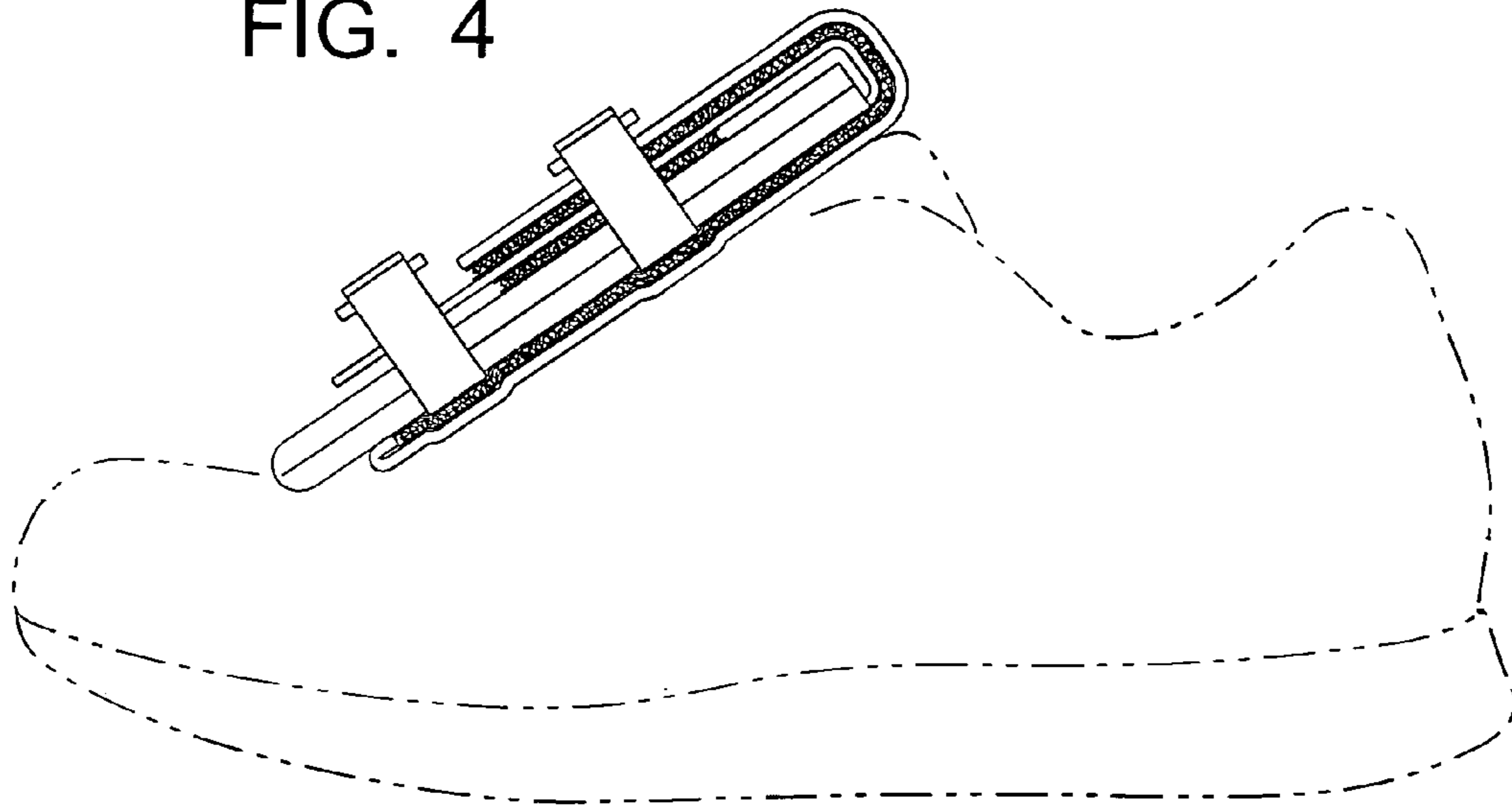

FIG. 5

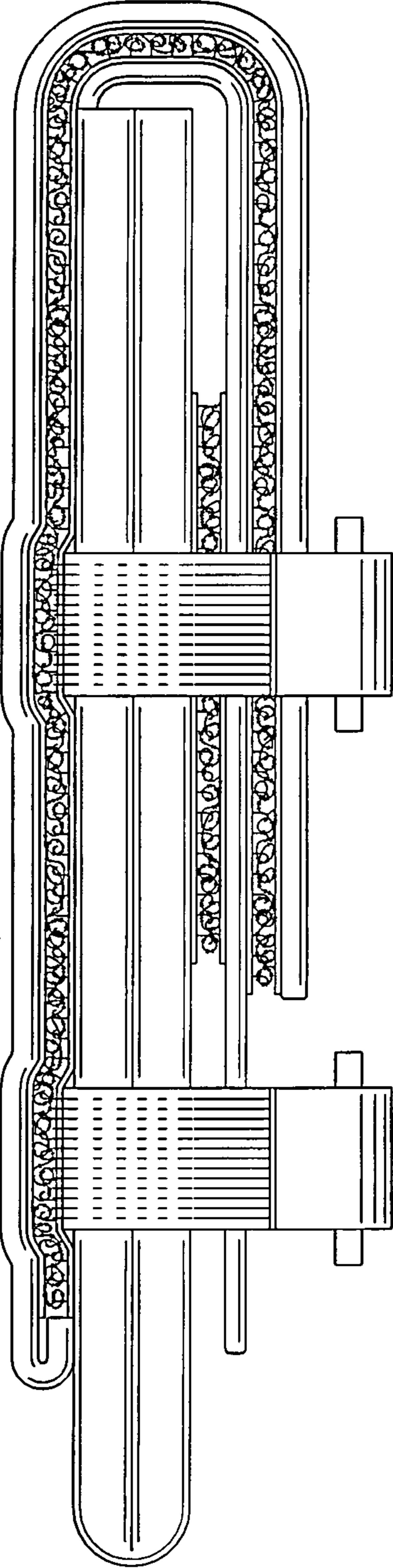

FIG. 6

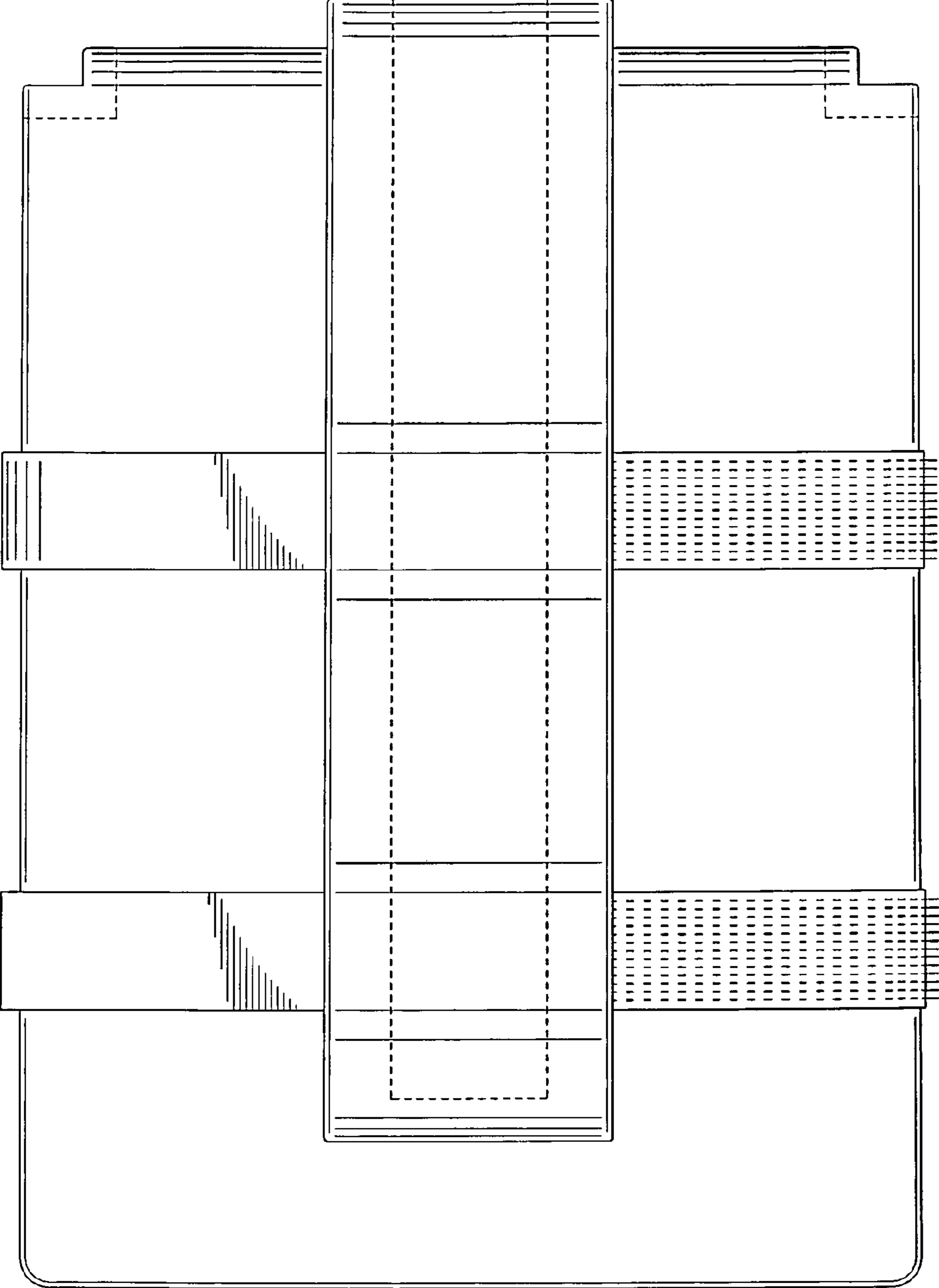



FIG. 7

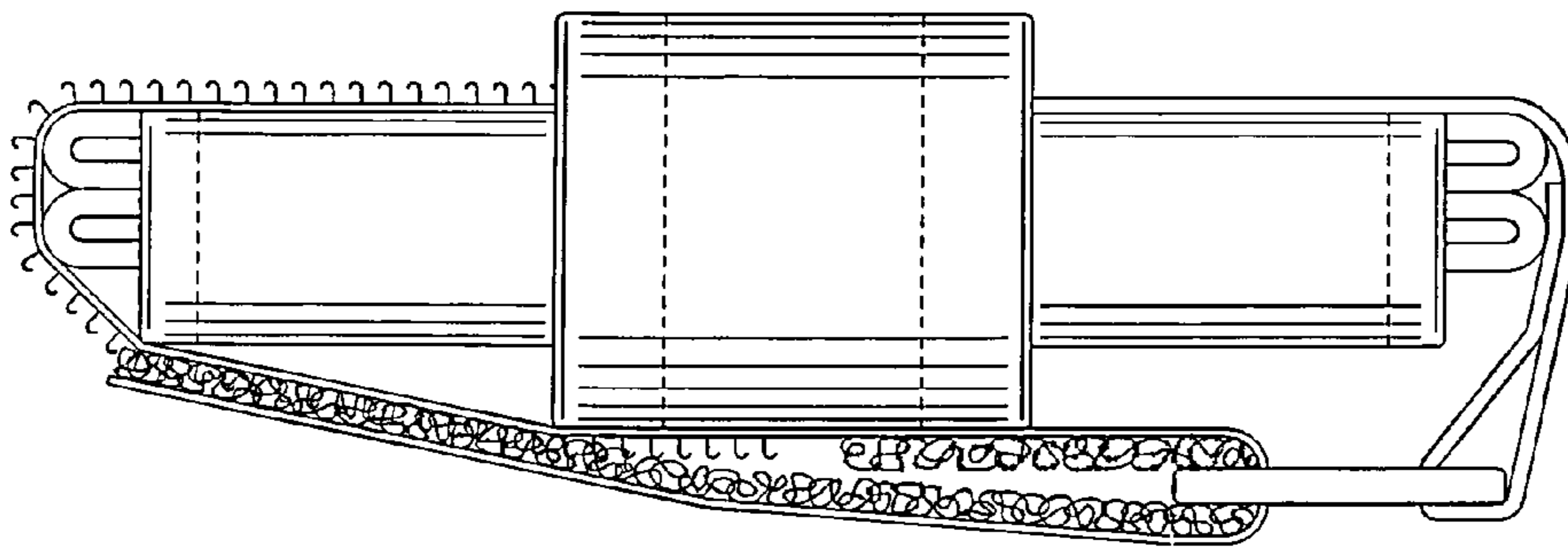

FIG. 8

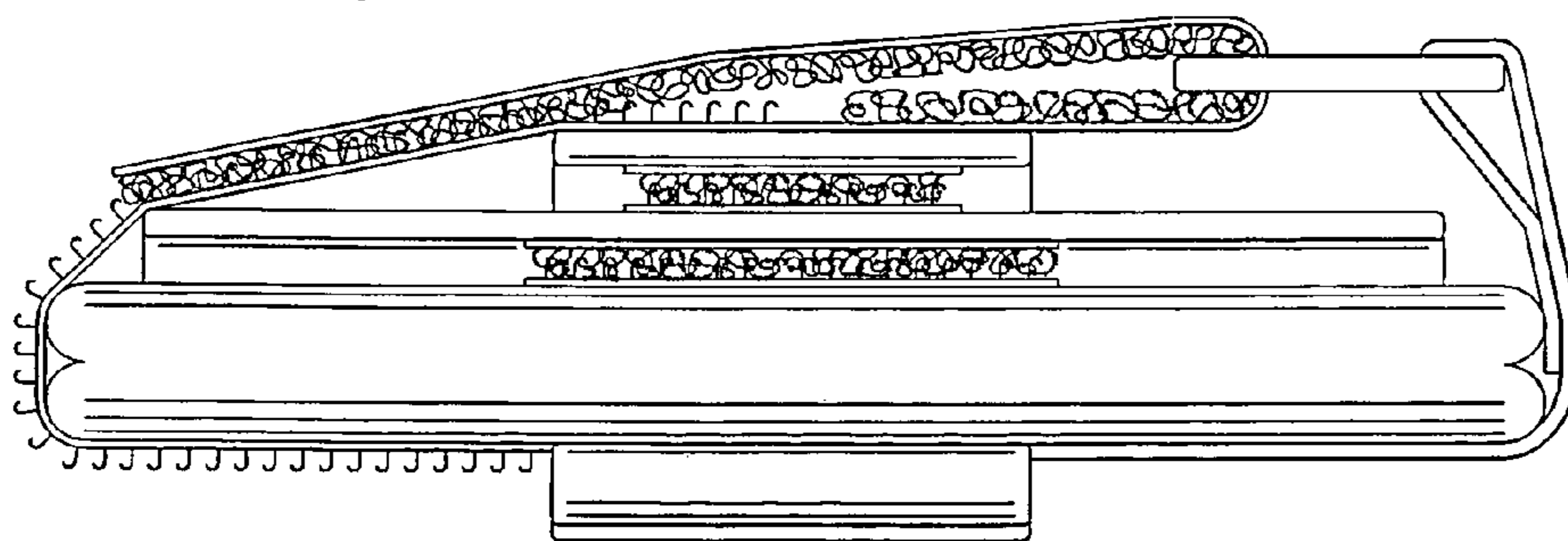

FIG. 9

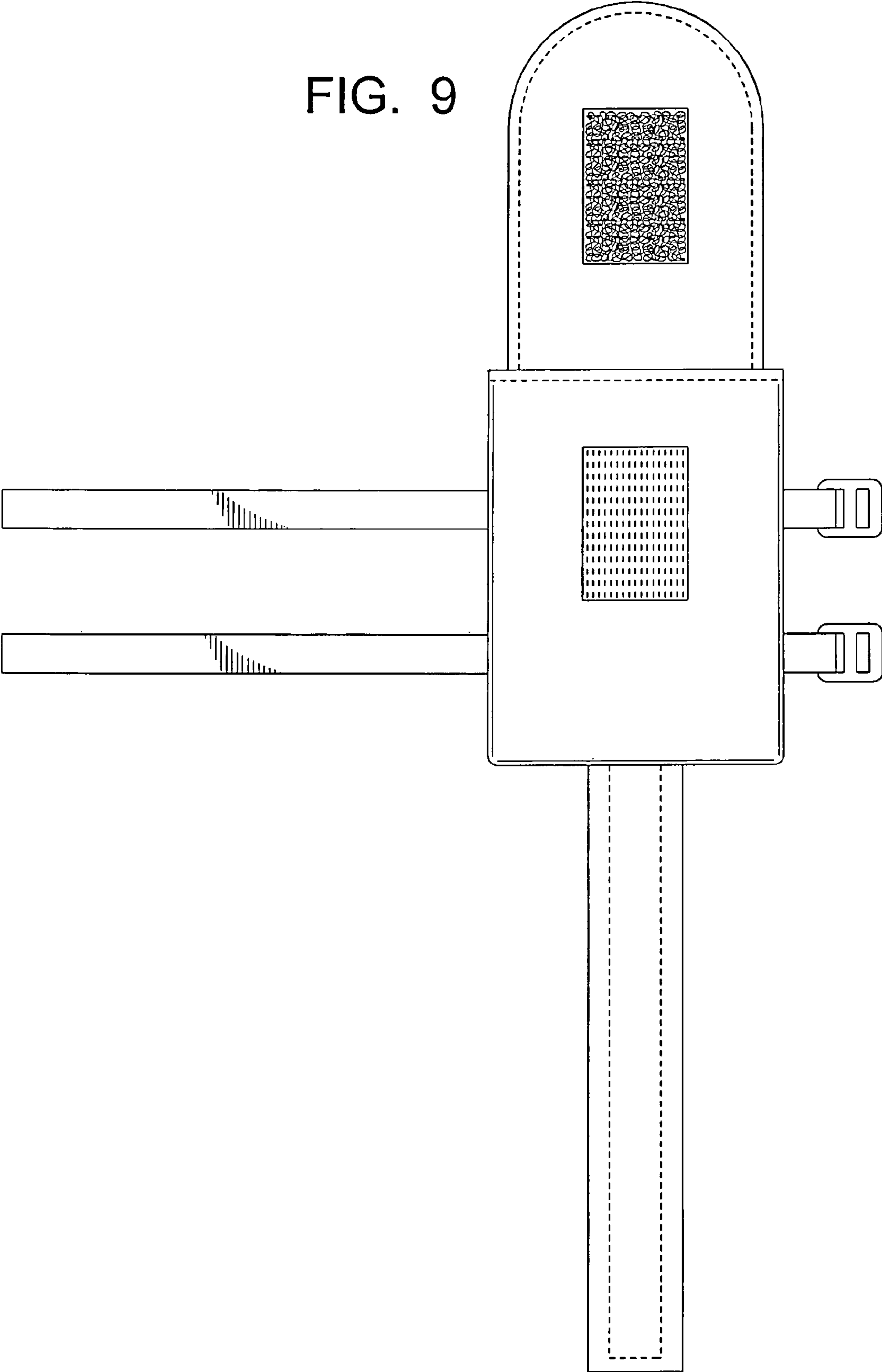



FIG. 10

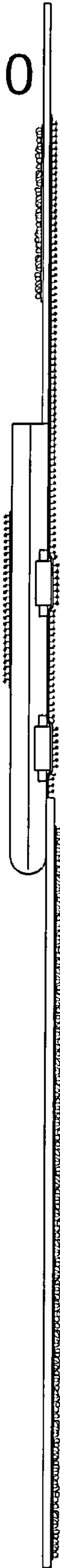

FIG. 11

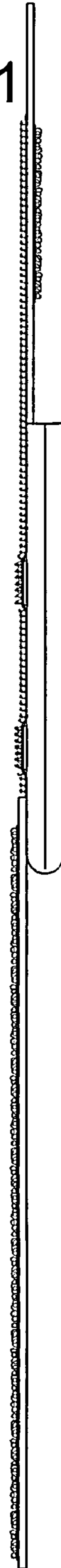

FIG. 12

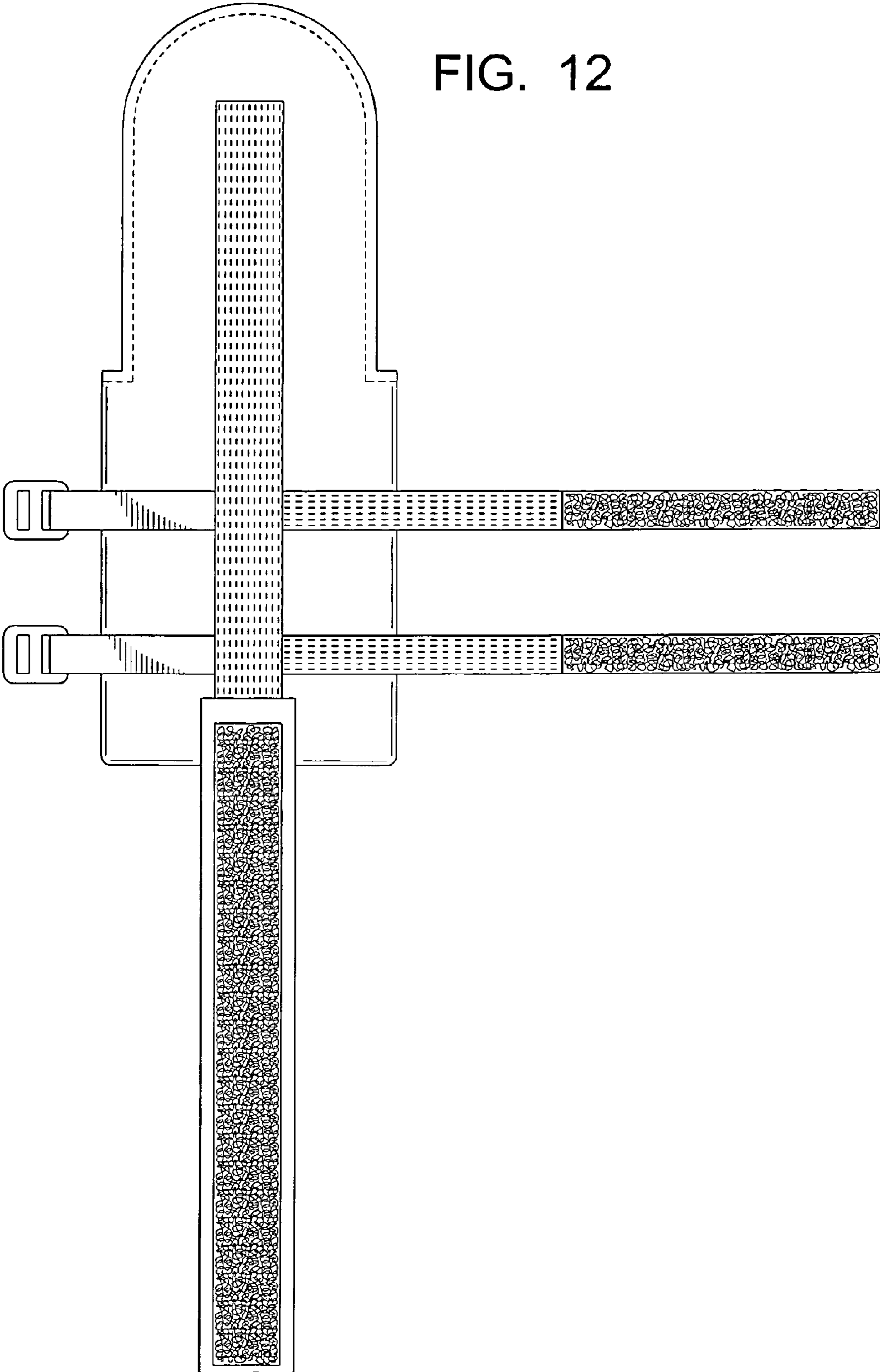

FIG. 13

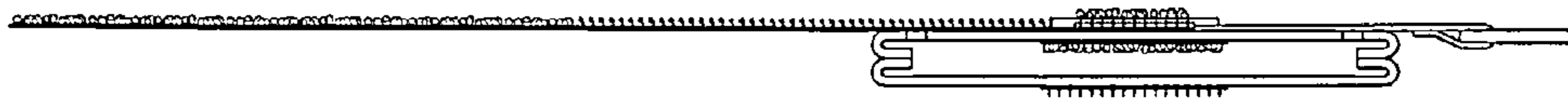

FIG. 14

