



US00D705532S

(12) **United States Design Patent**
Kolton

(10) **Patent No.:** **US D705,532 S**

(45) **Date of Patent:** **** May 27, 2014**

(54) **HEADPHONE CASE**

(71) Applicant: **Timothy Val Kolton**, Arlington, TX
(US)

(72) Inventor: **Timothy Val Kolton**, Arlington, TX
(US)

(**) Term: **14 Years**

(21) Appl. No.: **29/456,872**

(22) Filed: **Jun. 4, 2013**

(51) **LOC (10) Cl.** **03-01**

(52) **U.S. Cl.**
USPC **D3/201; D3/294**

(58) **Field of Classification Search**
USPC D3/201, 205, 218, 285, 294–295;
206/308.1, 702; D6/407, 631–632;
452/105, 132

See application file for complete search history.

(56) **References Cited**

U.S. PATENT DOCUMENTS

D418,287 S * 1/2000 Moor D3/201
D489,529 S * 5/2004 Vish et al. D3/301

D570,098 S * 6/2008 Luzon D3/205
D602,245 S * 10/2009 Christie et al. D3/205
D604,501 S * 11/2009 Lee D3/201
D609,009 S * 2/2010 Schaal et al. D3/294
D620,256 S * 7/2010 Fujimura et al. D3/294
2007/0256946 A1* 11/2007 Godshaw et al. 206/320

* cited by examiner

Primary Examiner — Catheri Oliver-Garcia

(74) *Attorney, Agent, or Firm* — Edwin Tarver; Lanson & Tarver, LLP

(57) **CLAIM**

The ornamental design for a headphone case, as shown and described.

DESCRIPTION

FIG. 1 is a perspective view of a headphone case;
FIG. 2 is a front view of a headphone case;
FIG. 3 is a rear view of a headphone case;
FIG. 4 is a top view of a headphone case;
FIG. 5 is a bottom view of a headphone case;
FIG. 6 is a right side view of a headphone case; and,
FIG. 7 is a left side view of a headphone case.
Portions of the drawings shown in dashed line are for illustrative purposes only, and form no part of the claimed design.

1 Claim, 7 Drawing Sheets

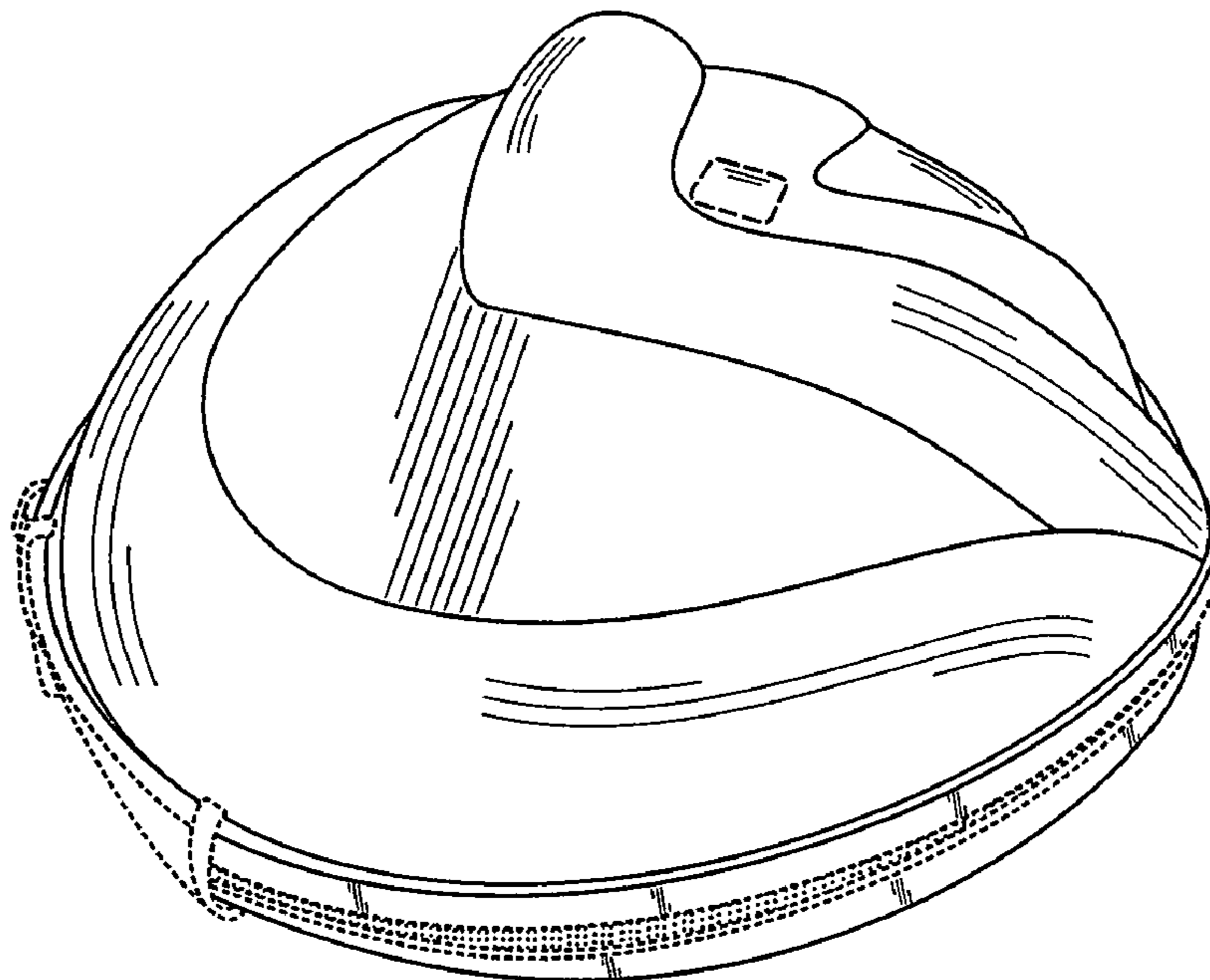

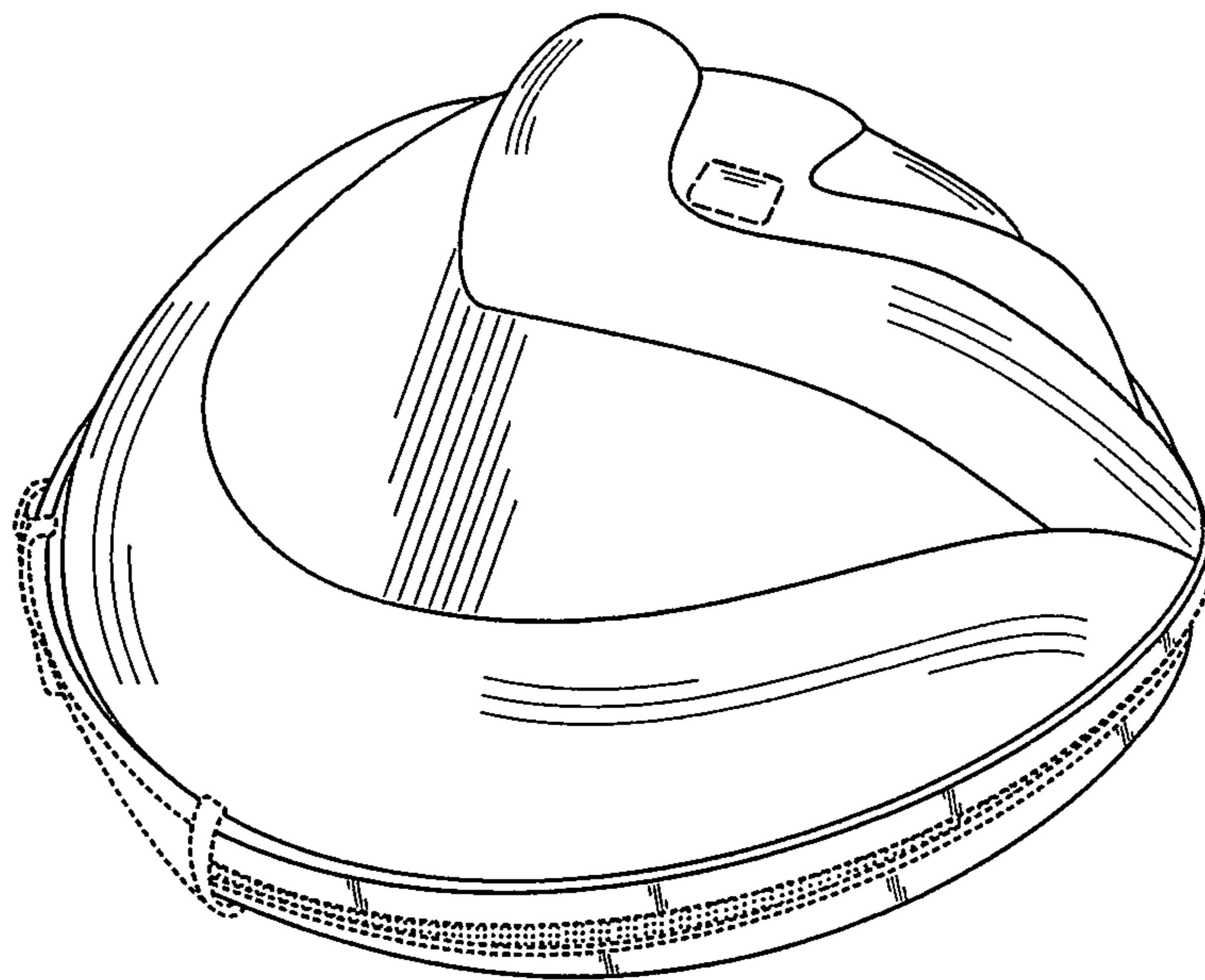

FIG. 1

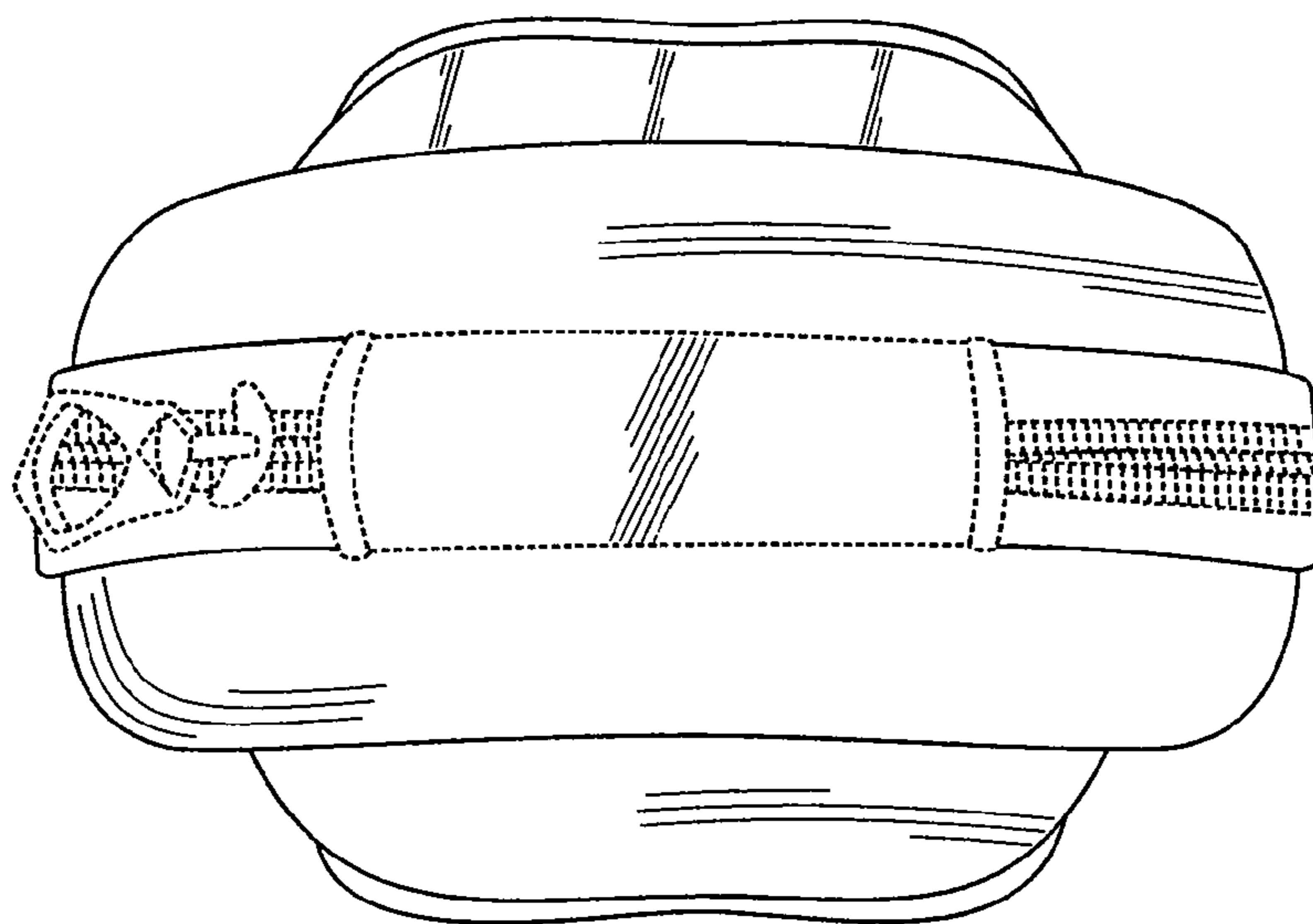

FIG. 2

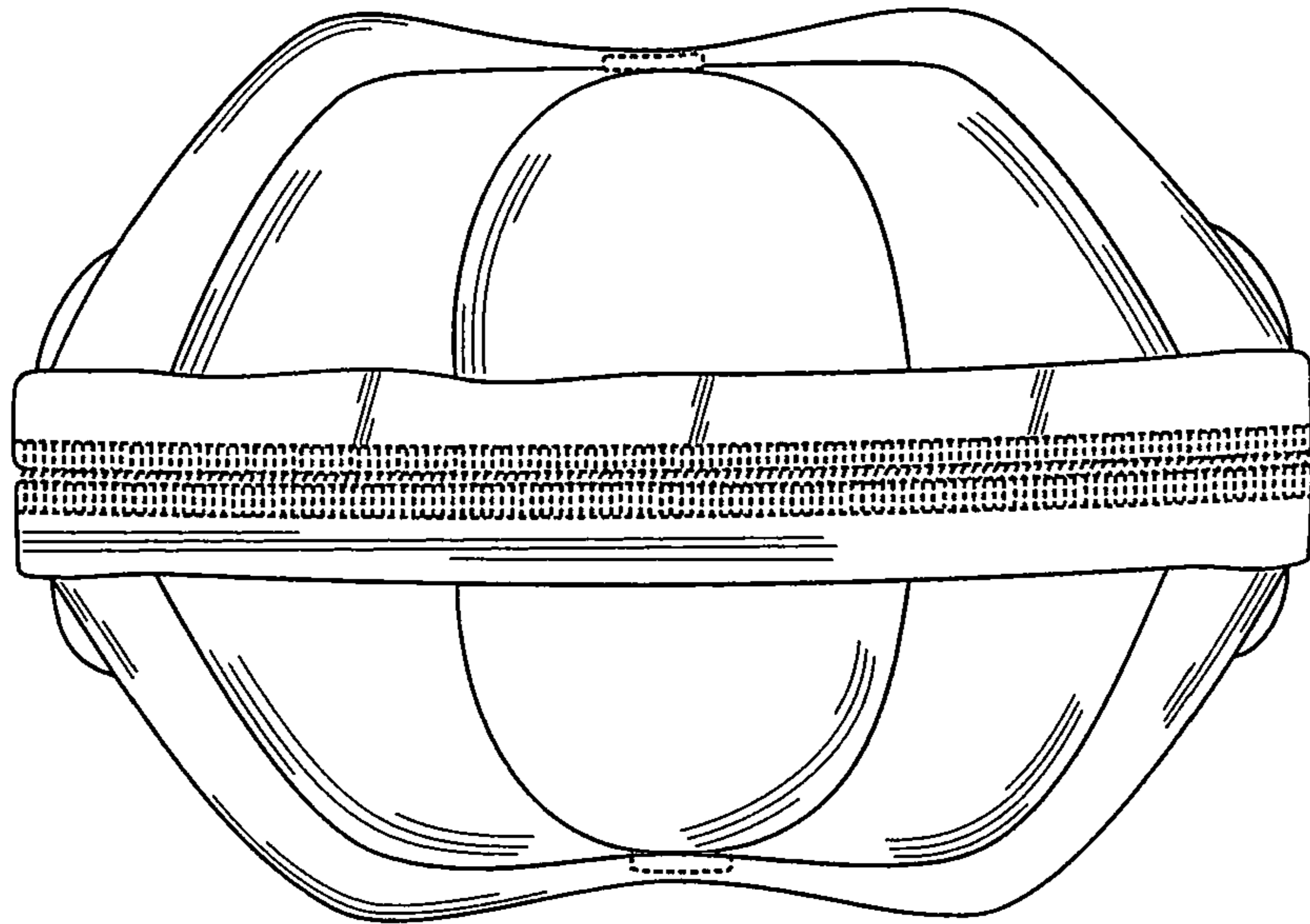

FIG. 3

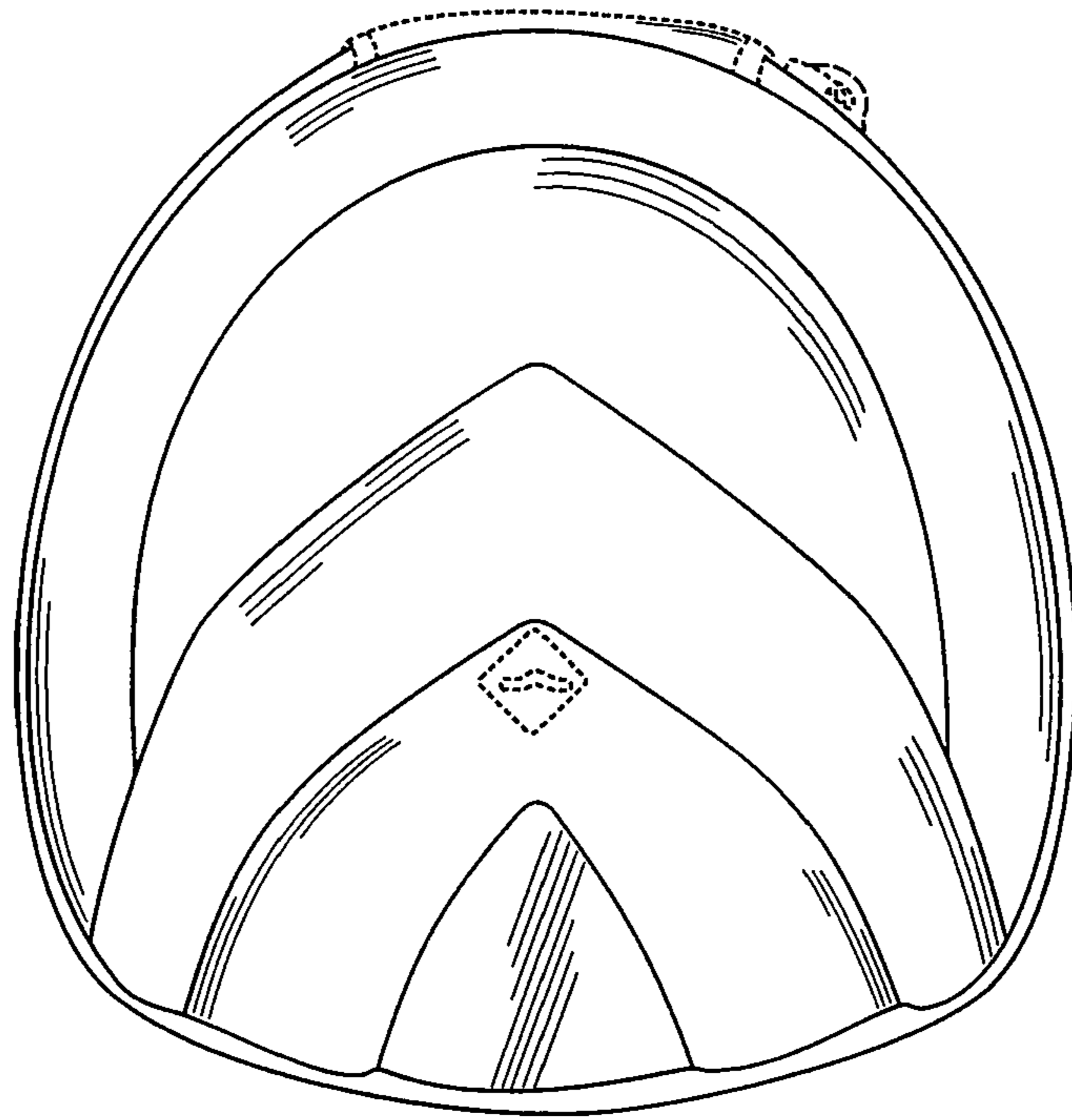

FIG. 4

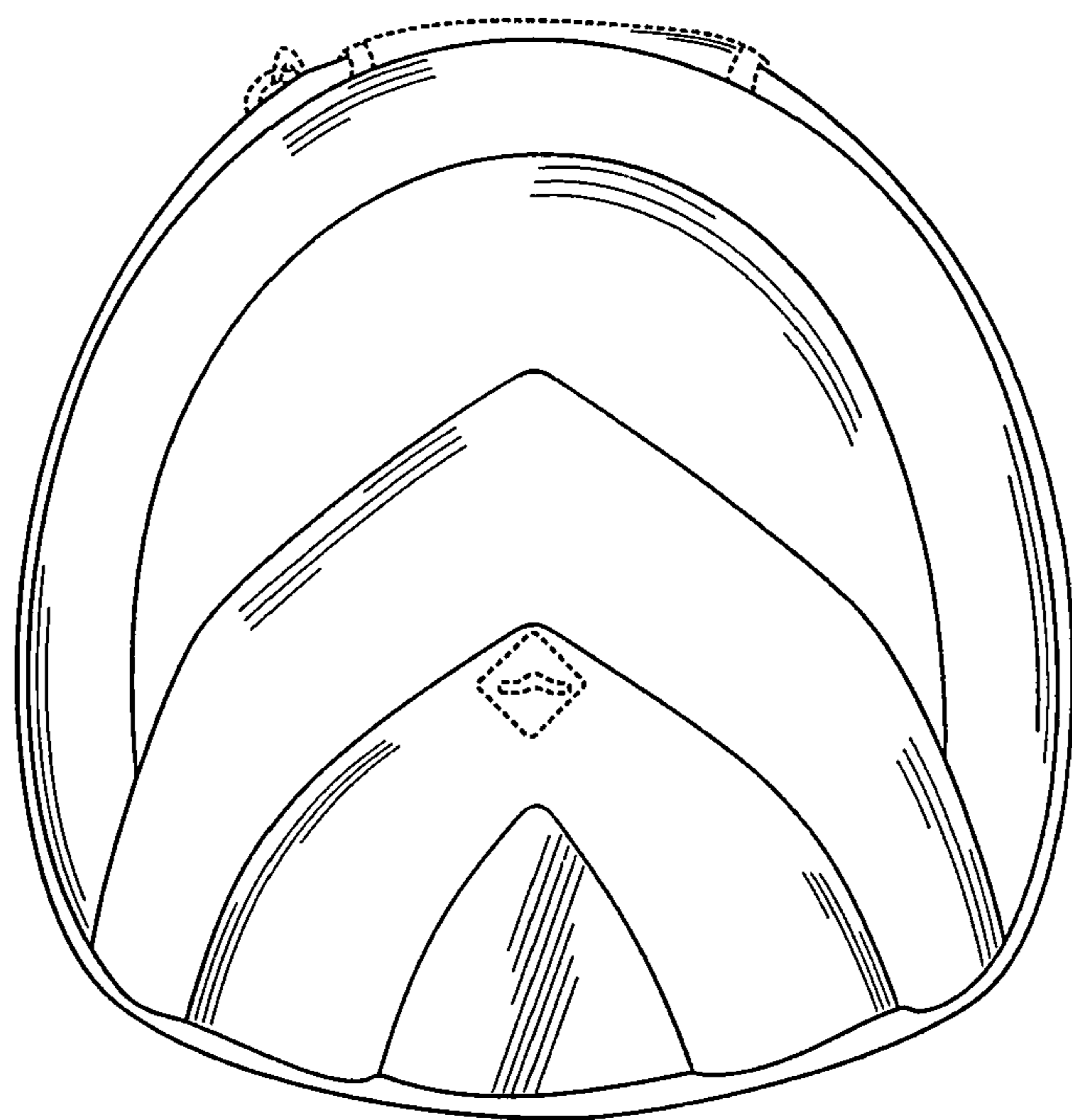

FIG. 5

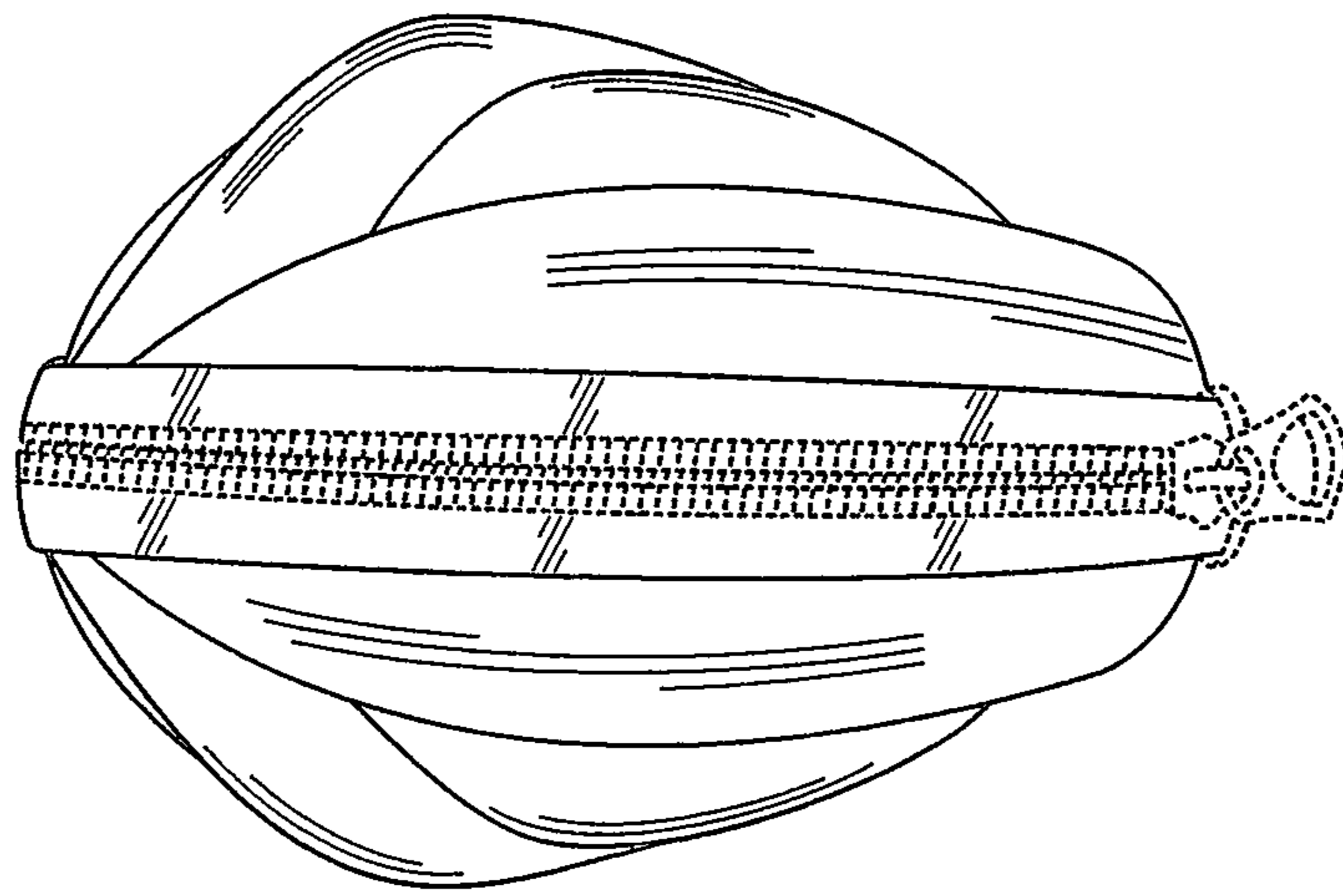

FIG. 6

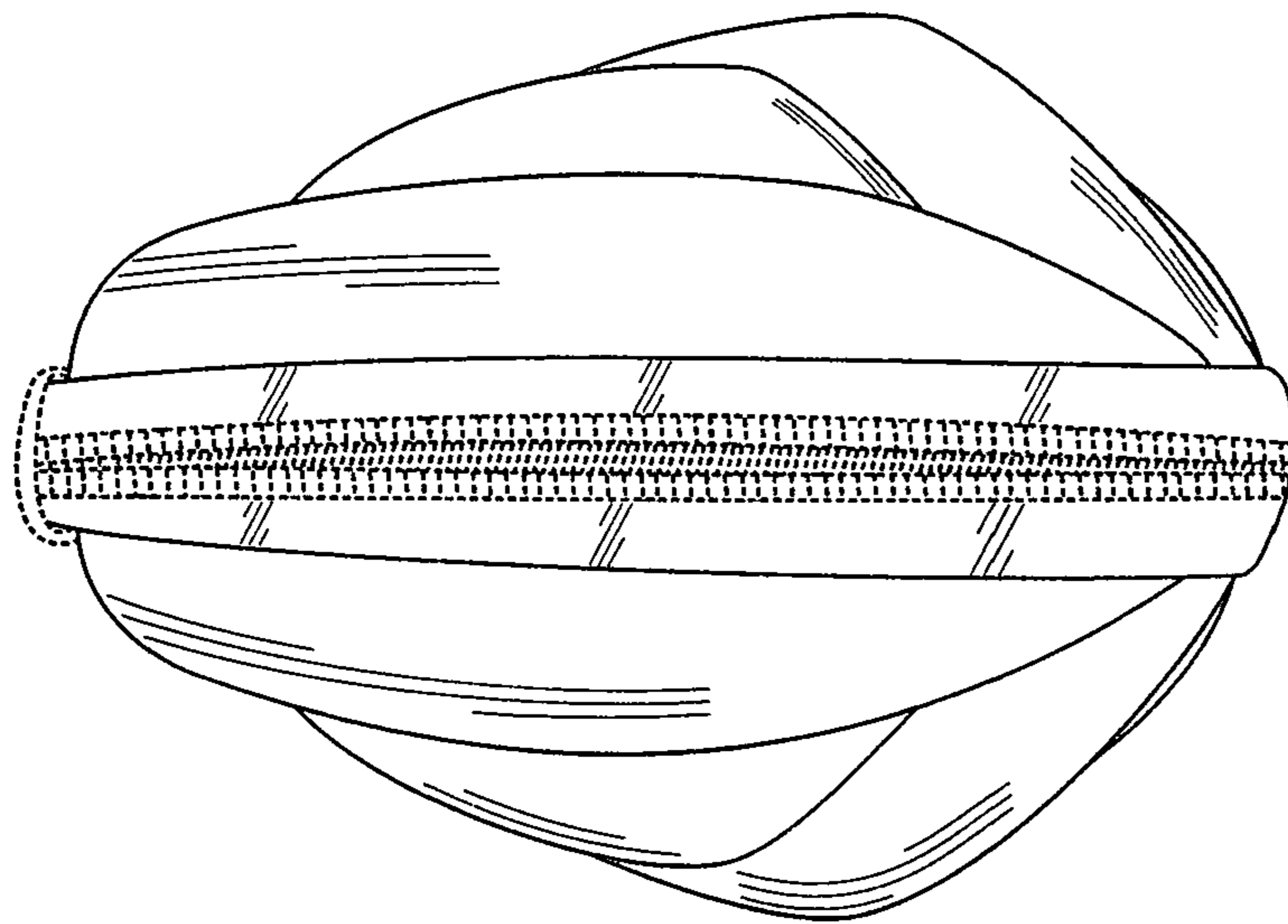

FIG. 7