



US00D705465S

(12) **United States Design Patent**  
**Sa et al.**

(10) **Patent No.:** **US D705,465 S**

(45) **Date of Patent:** **\*\* May 20, 2014**

(54) **REAR COMBINATION LAMP FOR AN  
AUTOMOBILE**

D552,769 S \* 10/2007 Leclercq ..... D26/28  
D553,269 S \* 10/2007 Pfeiffer et al. .... D26/28  
D574,524 S \* 8/2008 Tomatsu ..... D26/28  
D605,793 S \* 12/2009 Weil ..... D26/28

(71) Applicant: **Kia Motors Corporation**, Seoul (KR)

\* cited by examiner

(72) Inventors: **Jung Woo Sa**, Hwaseong (KR); **Sung  
Wook Kim**, Seoul (KR)

*Primary Examiner* — Marcus Jackson

(73) Assignee: **Kia Motors Corporation**, Seoul (KR)

(74) *Attorney, Agent, or Firm* — Edwards Wildman Palmer  
LLP

(\*\*) Term: **14 Years**

(57) **CLAIM**

(21) Appl. No.: **29/421,801**

The ornamental design for a rear combination lamp for an  
automobile, as shown and described.

(22) Filed: **Sep. 25, 2012**

**DESCRIPTION**

(30) **Foreign Application Priority Data**

May 30, 2012 (KR) ..... 30-2012-0026669

(51) **LOC (10) Cl.** ..... **26-06**

(52) **U.S. Cl.**  
USPC ..... **D26/28**

(58) **Field of Classification Search**  
USPC ..... D26/28-36; 362/459-468, 475-478,  
362/485-487  
See application file for complete search history.

FIG. 1 is a perspective view of a rear combination lamp for an  
automobile according to the present invention.

FIG. 2 is a front view of the rear combination lamp for an  
automobile of FIG. 1.

FIG. 3 is a rear view of the rear combination lamp for an  
automobile of FIG. 1.

FIG. 4 is a left side view of the rear combination lamp for an  
automobile of FIG. 1.

FIG. 5 is a right side view of the rear combination lamp for an  
automobile of FIG. 1.

FIG. 6 is a top view of the rear combination lamp for an  
automobile of FIG. 1; and,

FIG. 7 is a bottom view of the rear combination lamp for an  
automobile of FIG. 1.

(56) **References Cited**

**U.S. PATENT DOCUMENTS**

D541,445 S \* 4/2007 Lin ..... D26/28  
D549,363 S \* 8/2007 Pfeiffer ..... D26/28

**1 Claim, 7 Drawing Sheets**

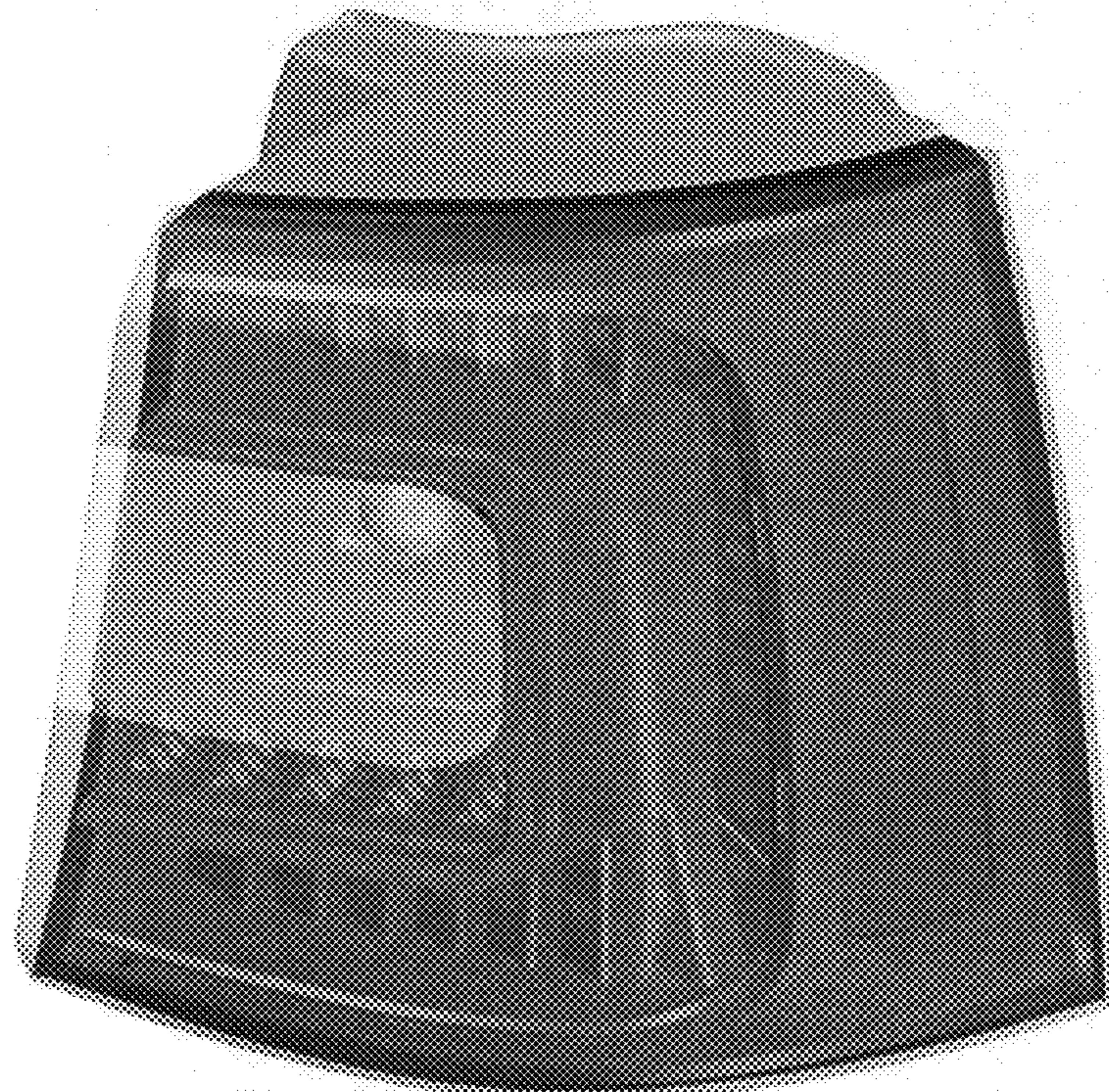

FIG. 1

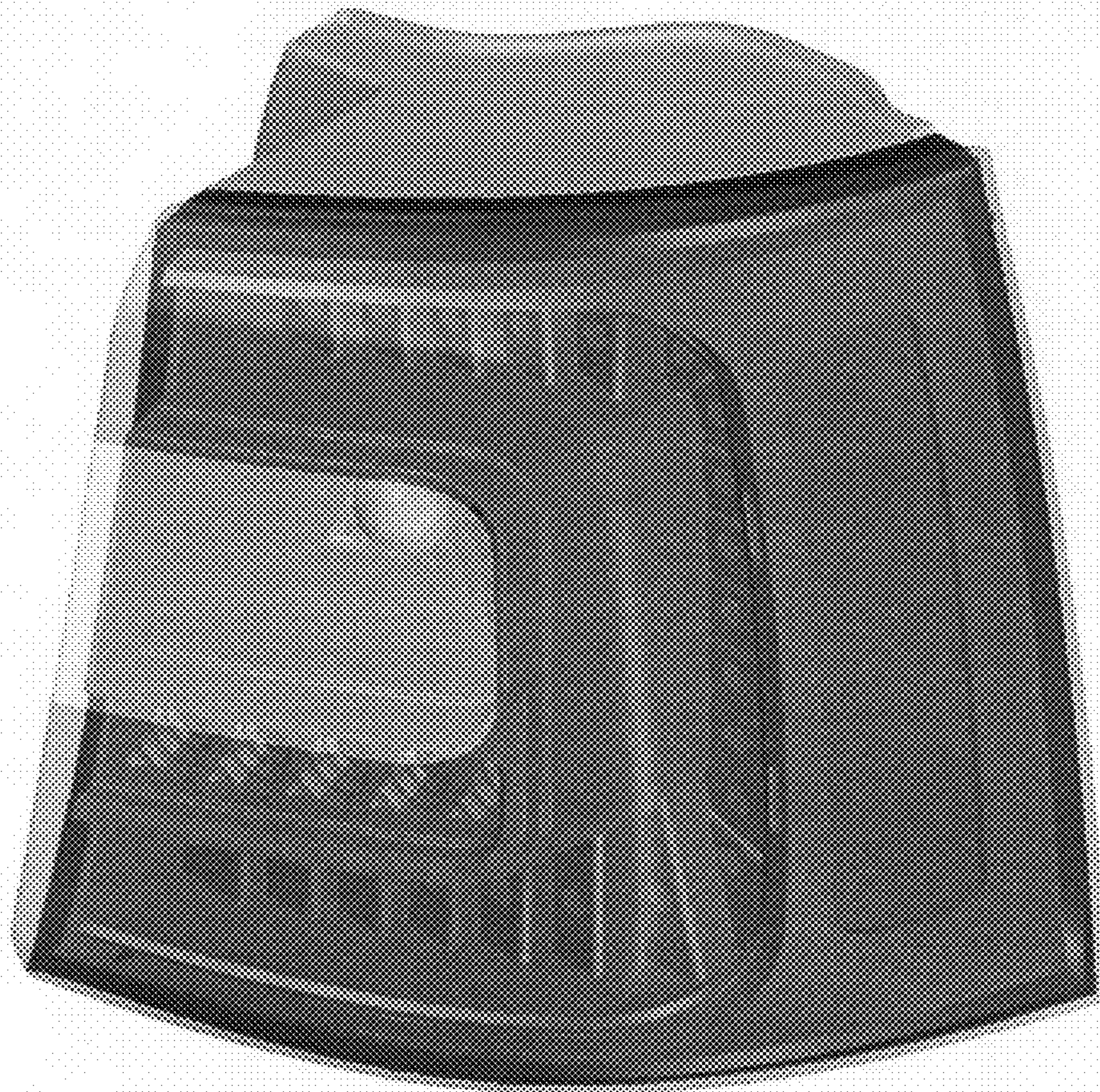

FIG. 2

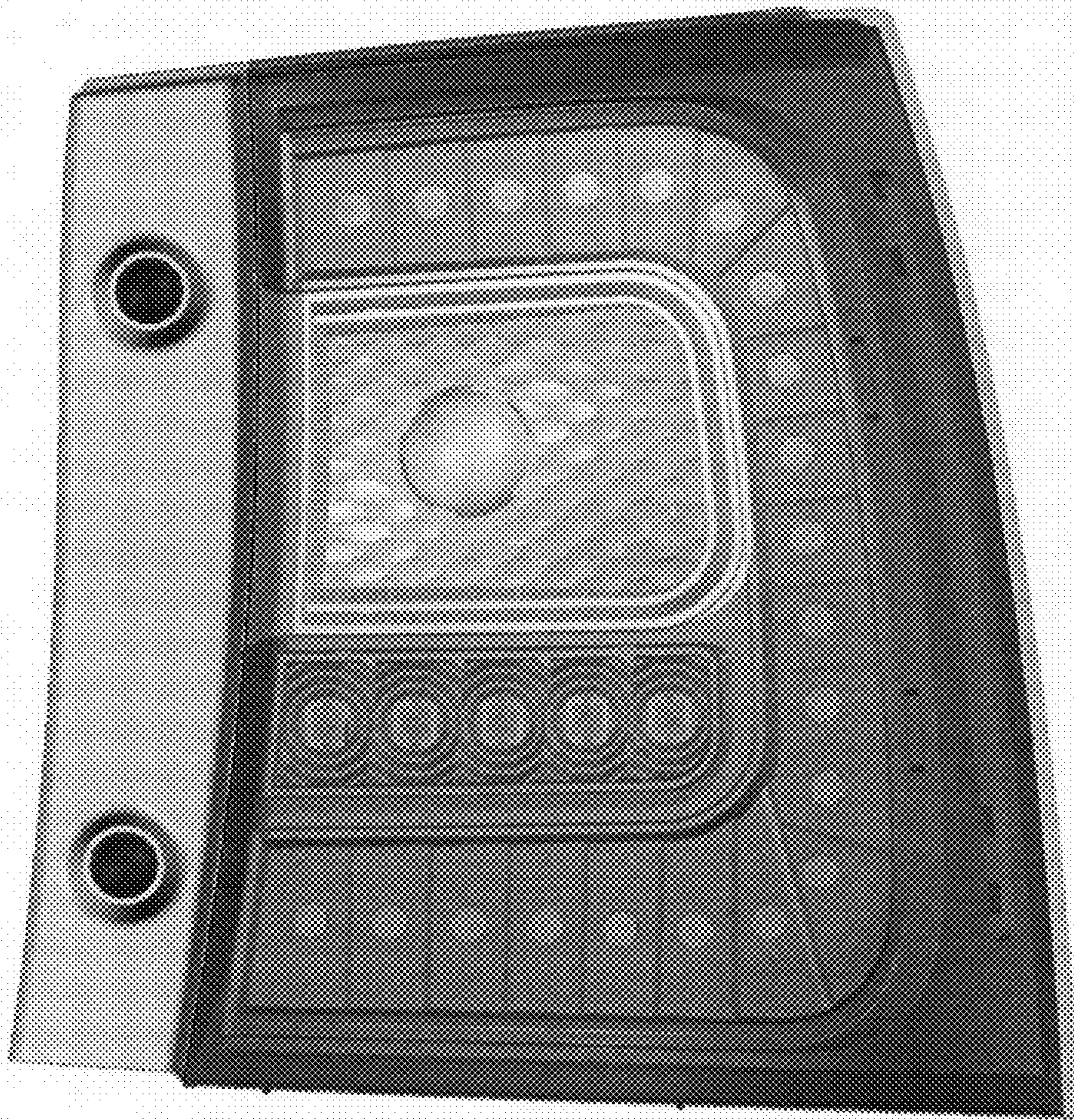

FIG. 3

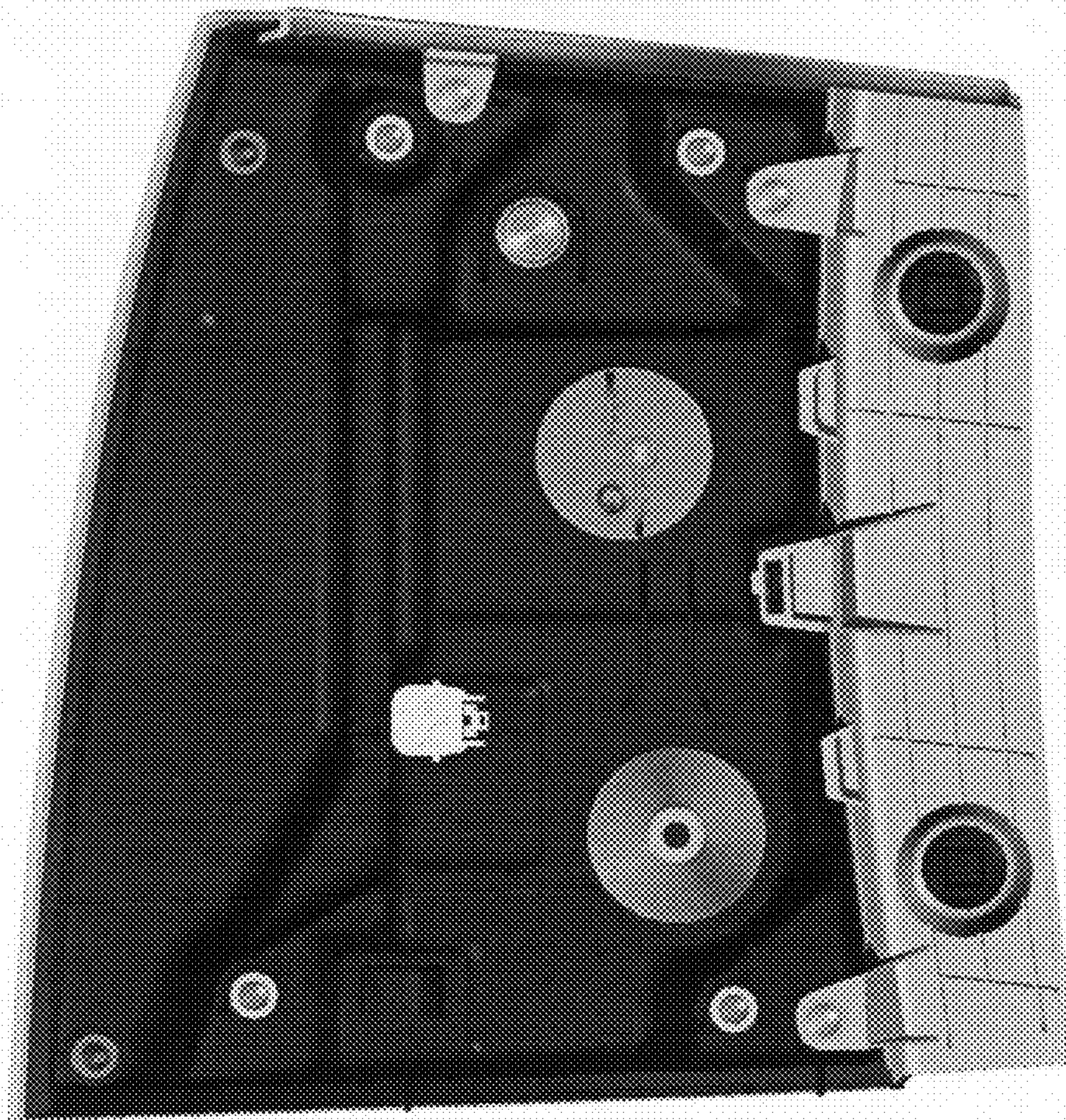

FIG. 4

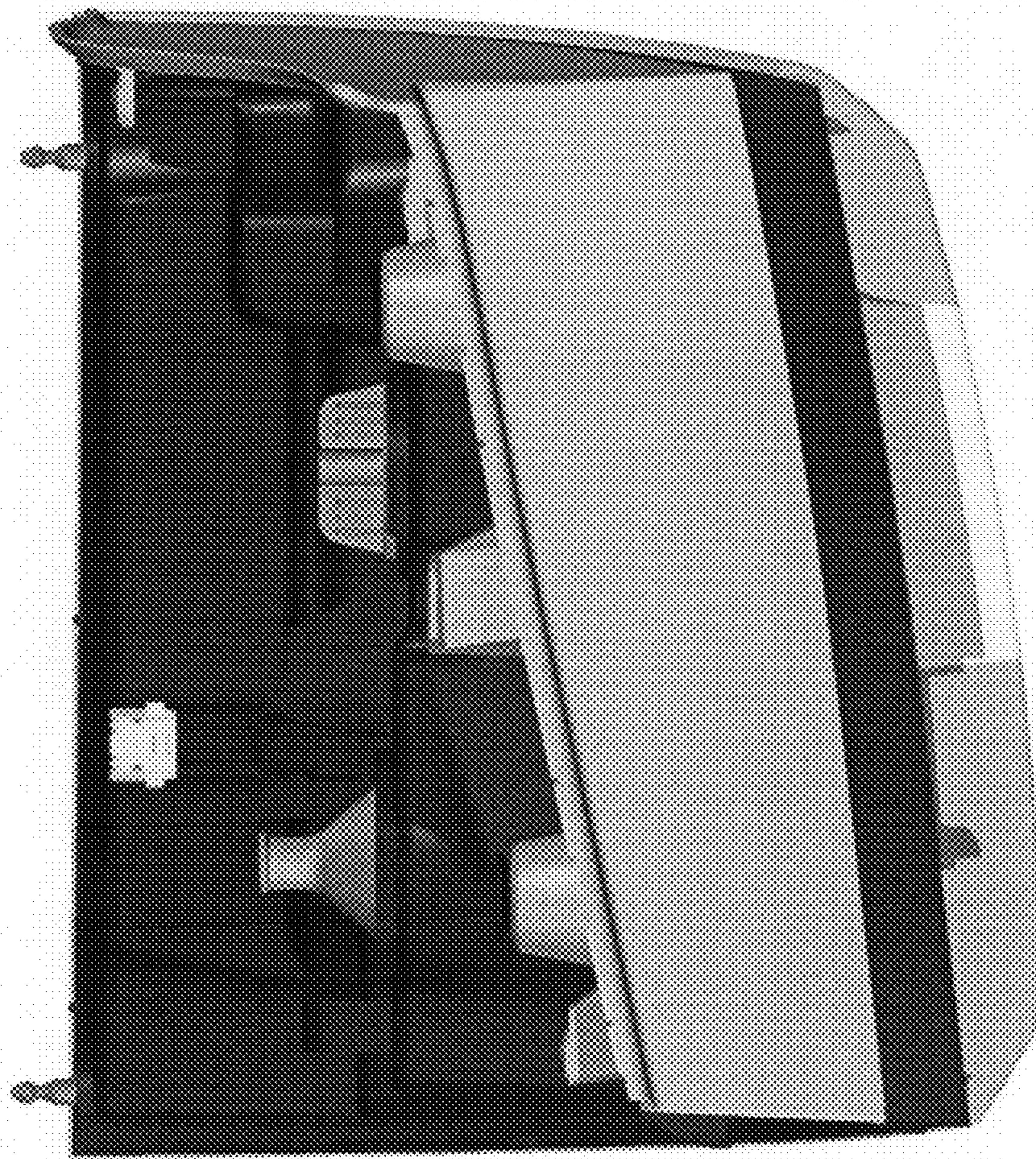

FIG. 5

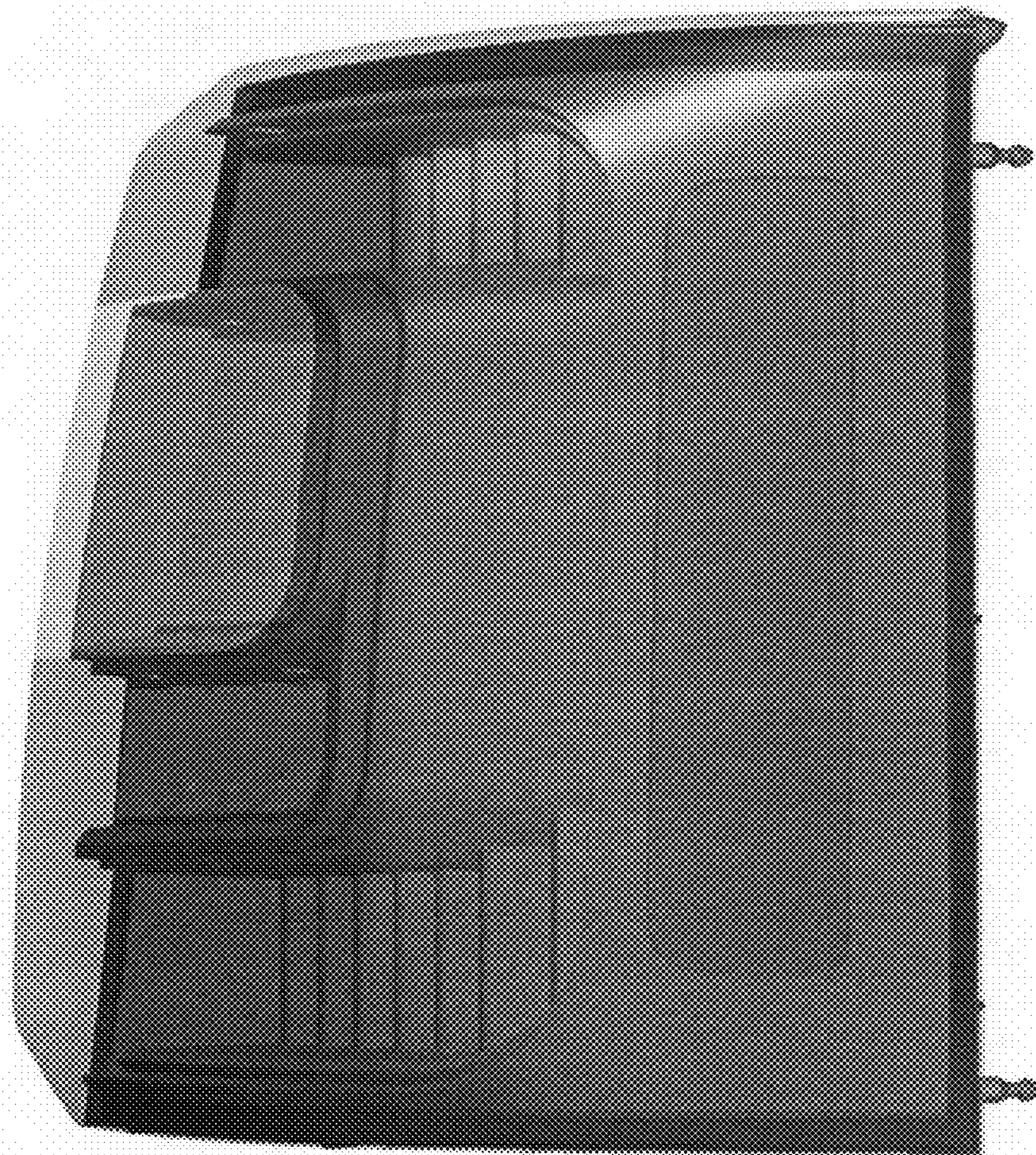

FIG. 6

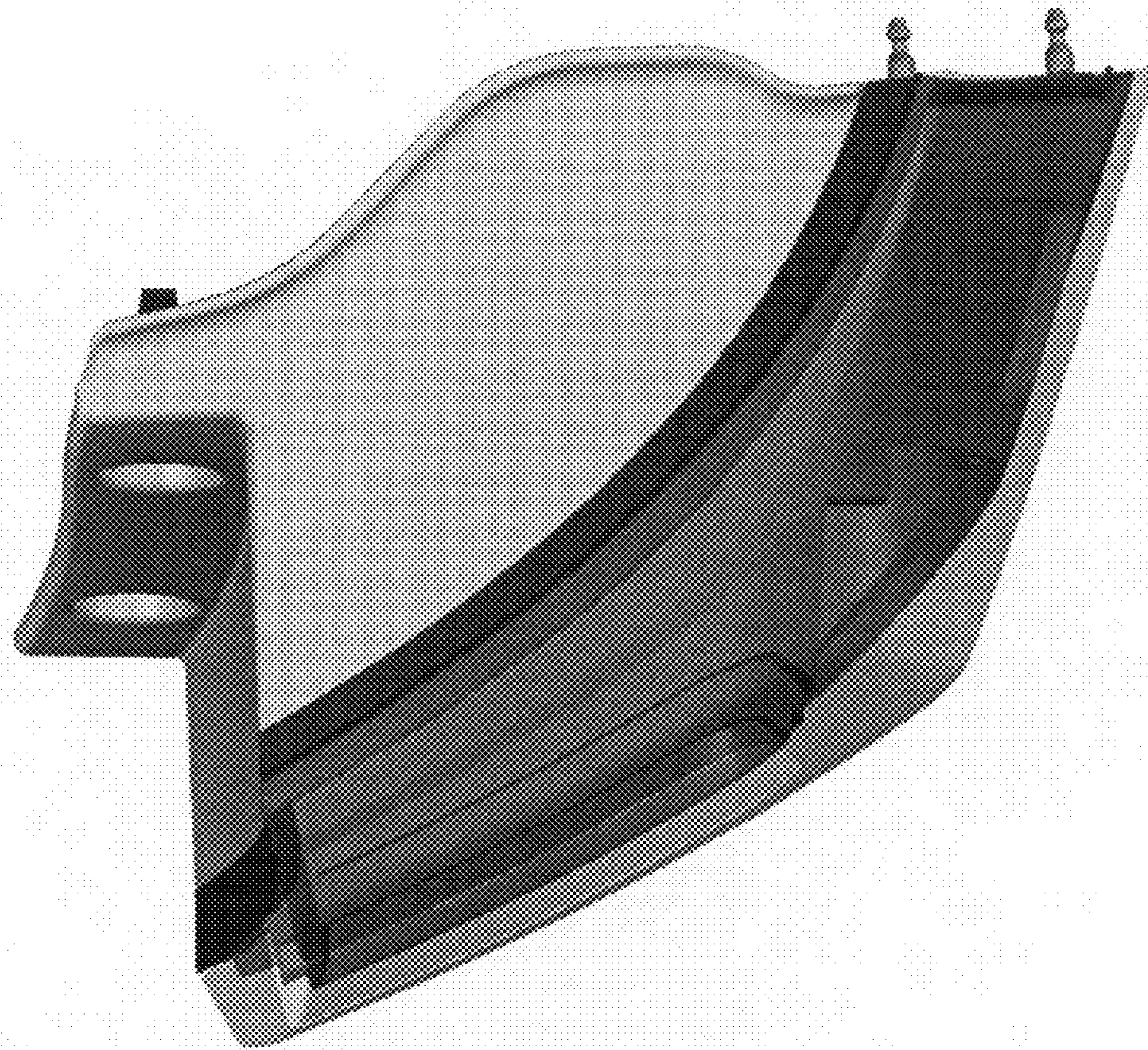

FIG. 7

