

US00D705453S

(12) **United States Design Patent**
Knapp et al.

(10) **Patent No.:** **US D705,453 S**

(45) **Date of Patent:** **** May 20, 2014**

(54) **COSMETIC DECK VENEER**

(75) Inventors: **Michael David Knapp**, Uxbridge (CA);
John Clinton McLister, Toronto (CA);
Kevin James Lawrence, Burlington (CA)

(73) Assignee: **Creative Style Composites, Inc.** (CA)

(**) Term: **14 Years**

(21) Appl. No.: **29/426,998**

(22) Filed: **Jul. 12, 2012**

(51) **LOC (10) Cl.** **25-01**

(52) **U.S. Cl.**
USPC **D25/138**

(58) **Field of Classification Search**
USPC D25/138; 52/384, 385, 386, 387, 390,
52/391, 392; 428/50
See application file for complete search history.

(56) **References Cited**

U.S. PATENT DOCUMENTS

D422,094 S *	3/2000	Wolfrum	D25/138
6,311,443 B1 *	11/2001	Allazetta	52/392
6,339,908 B1 *	1/2002	Chuang	52/589.1
6,647,684 B1 *	11/2003	Gank	52/385
6,694,689 B1 *	2/2004	Scott et al.	52/392

* cited by examiner

Primary Examiner — Doris Clark

(74) *Attorney, Agent, or Firm* — Smith, Gambrell & Russell

(57) **CLAIM**

The ornamental design for a cosmetic deck veneer, as shown and described.

DESCRIPTION

FIG. 1 is a top view in perspective of a first embodiment of a cosmetic deck veneer showing our new design;
 FIG. 2 is a bottom view in perspective of the embodiment of FIG. 1;
 FIG. 3 is a bottom plan view of the embodiment of FIG. 1;
 FIG. 4 is a top plan view of the embodiment of FIG. 1;
 FIG. 5 is a right side view of the embodiment of FIG. 1;
 FIG. 6 is a front view of the embodiment of FIG. 1;
 FIG. 7 is a left side view of the embodiment of FIG. 1; and
 FIG. 8 is a back view of the embodiment of FIG. 1.
 FIG. 9 is a top view in perspective of a second embodiment of a cosmetic deck veneer showing our new design;
 FIG. 10 is a bottom view in perspective of the embodiment of FIG. 9;
 FIG. 11 is a bottom plan view of the embodiment of FIG. 9;
 FIG. 12 is a top plan view of the embodiment of FIG. 9;
 FIG. 13 is a right side view of the embodiment of FIG. 9;
 FIG. 14 is a front view of the embodiment of FIG. 9;
 FIG. 15 is a left side view of the embodiment of FIG. 9; and,
 FIG. 16 is a back view of the embodiment of FIG. 9.

1 Claim, 16 Drawing Sheets

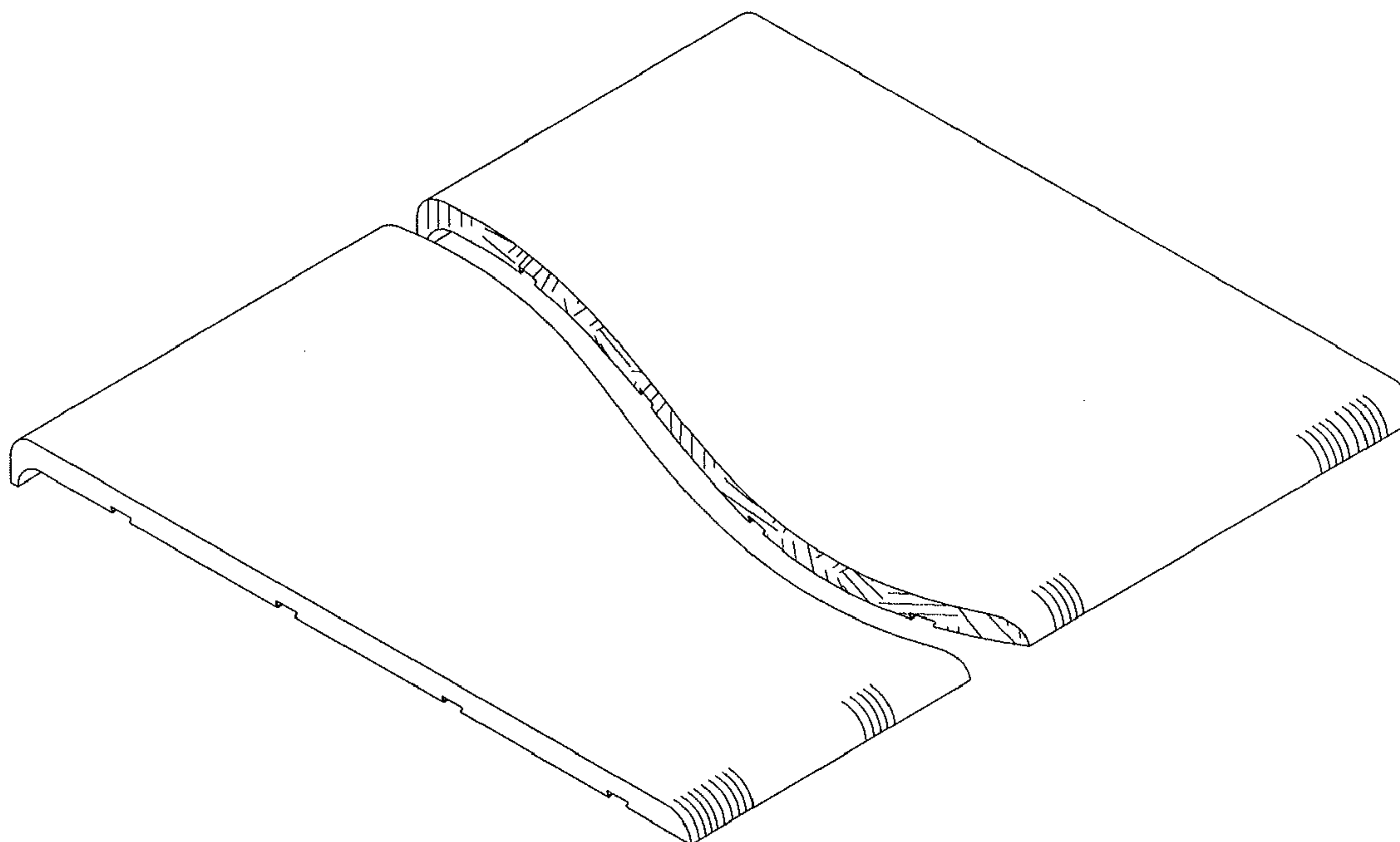

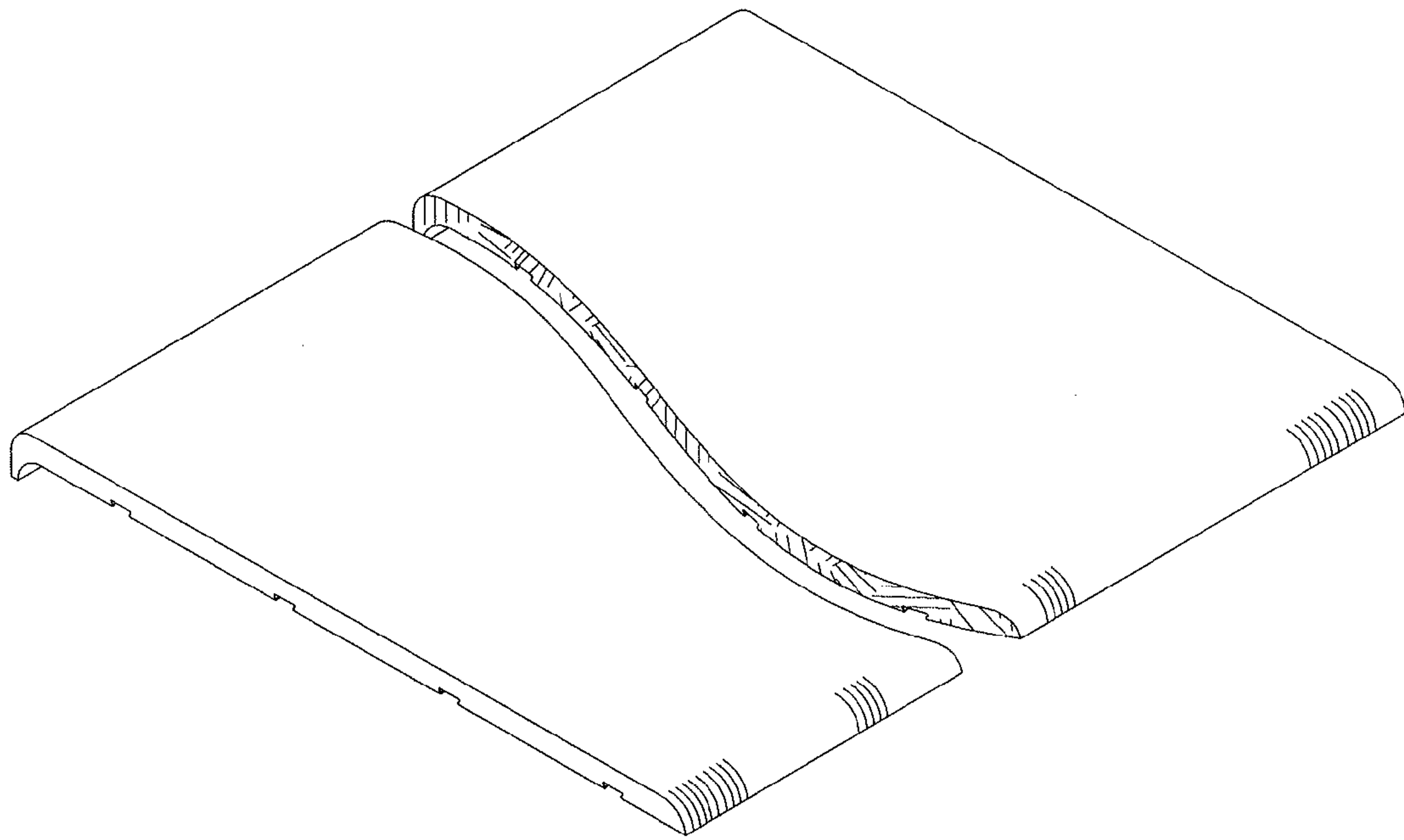

FIG. 1

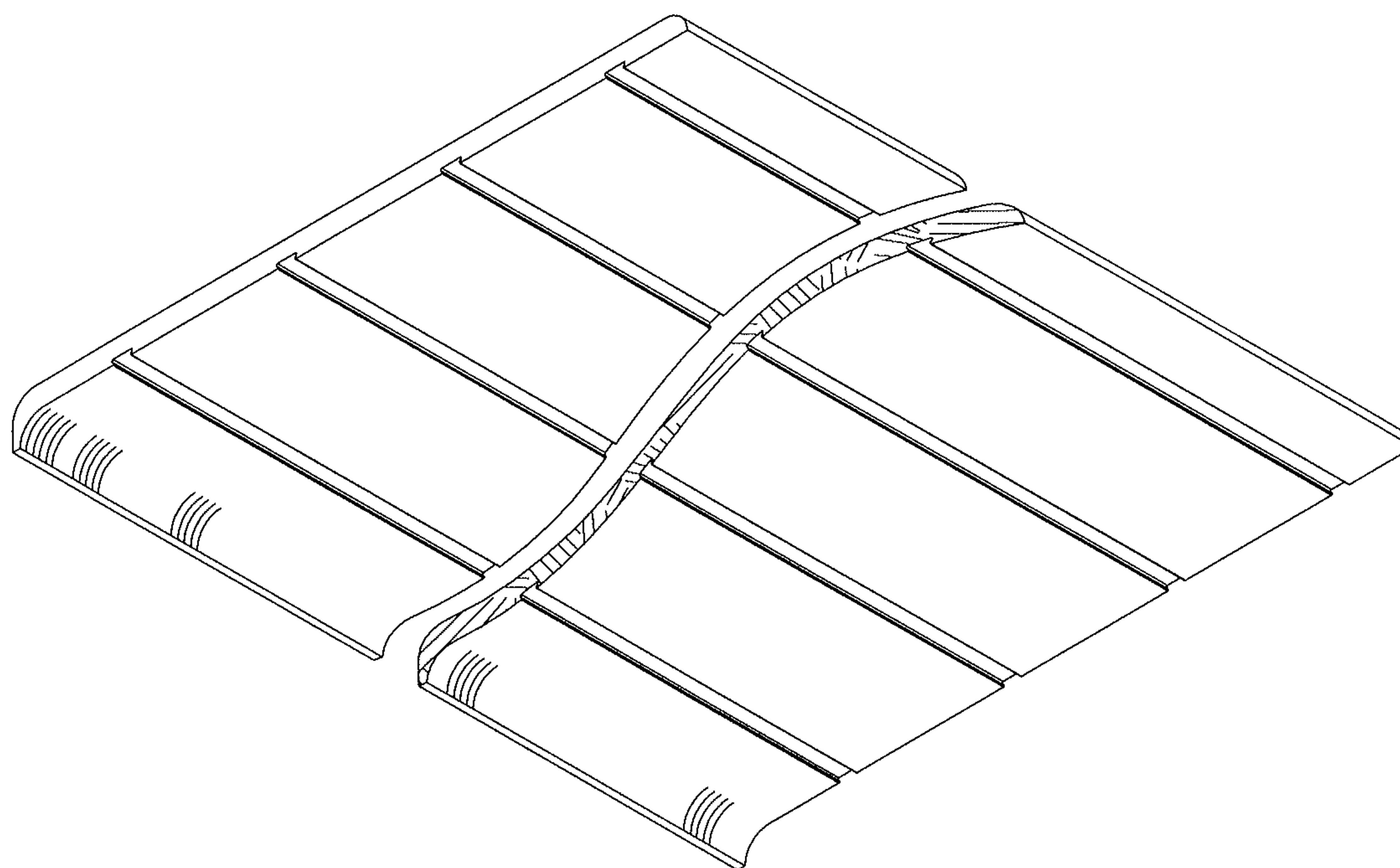

FIG. 2

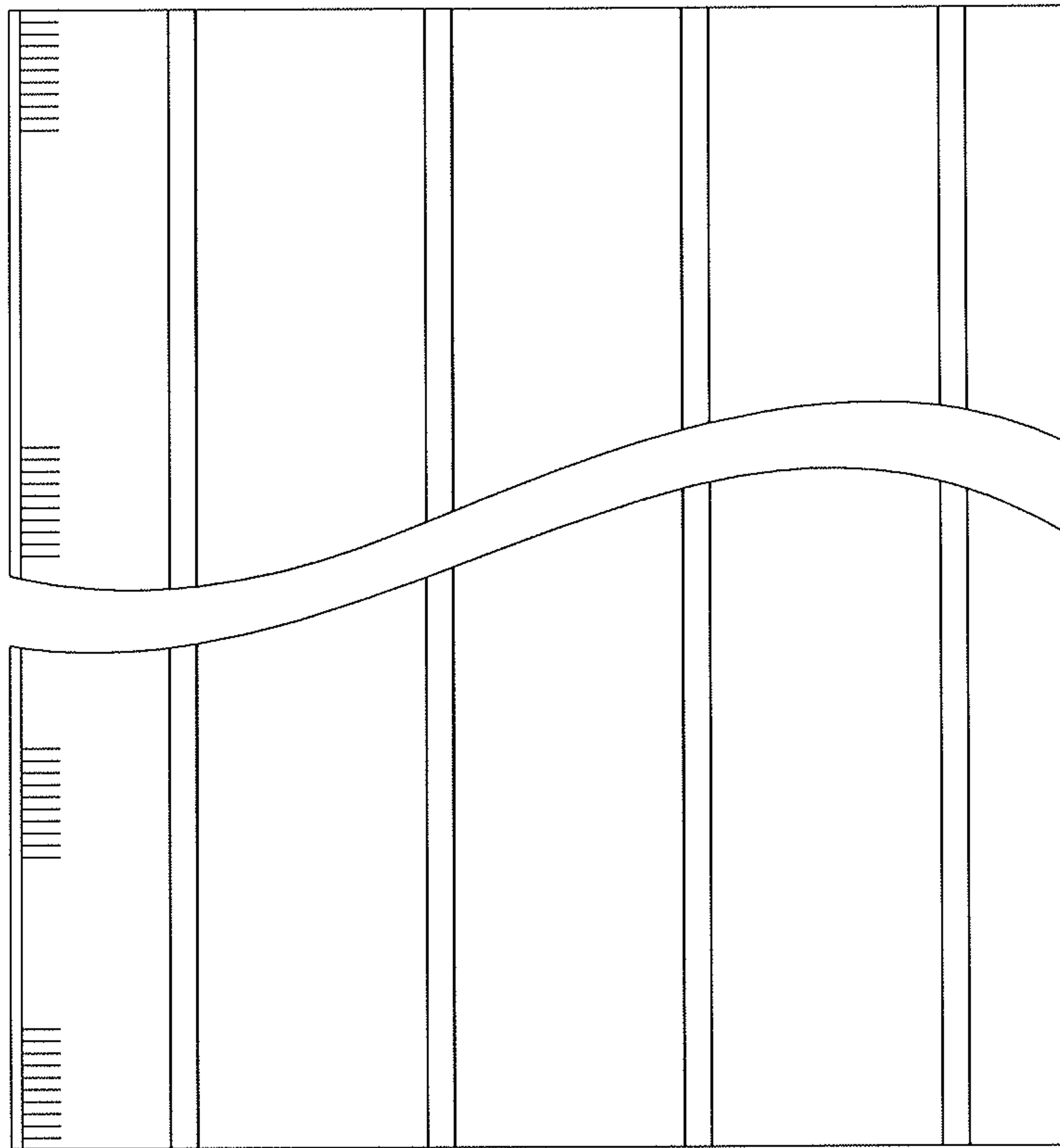

FIG. 3

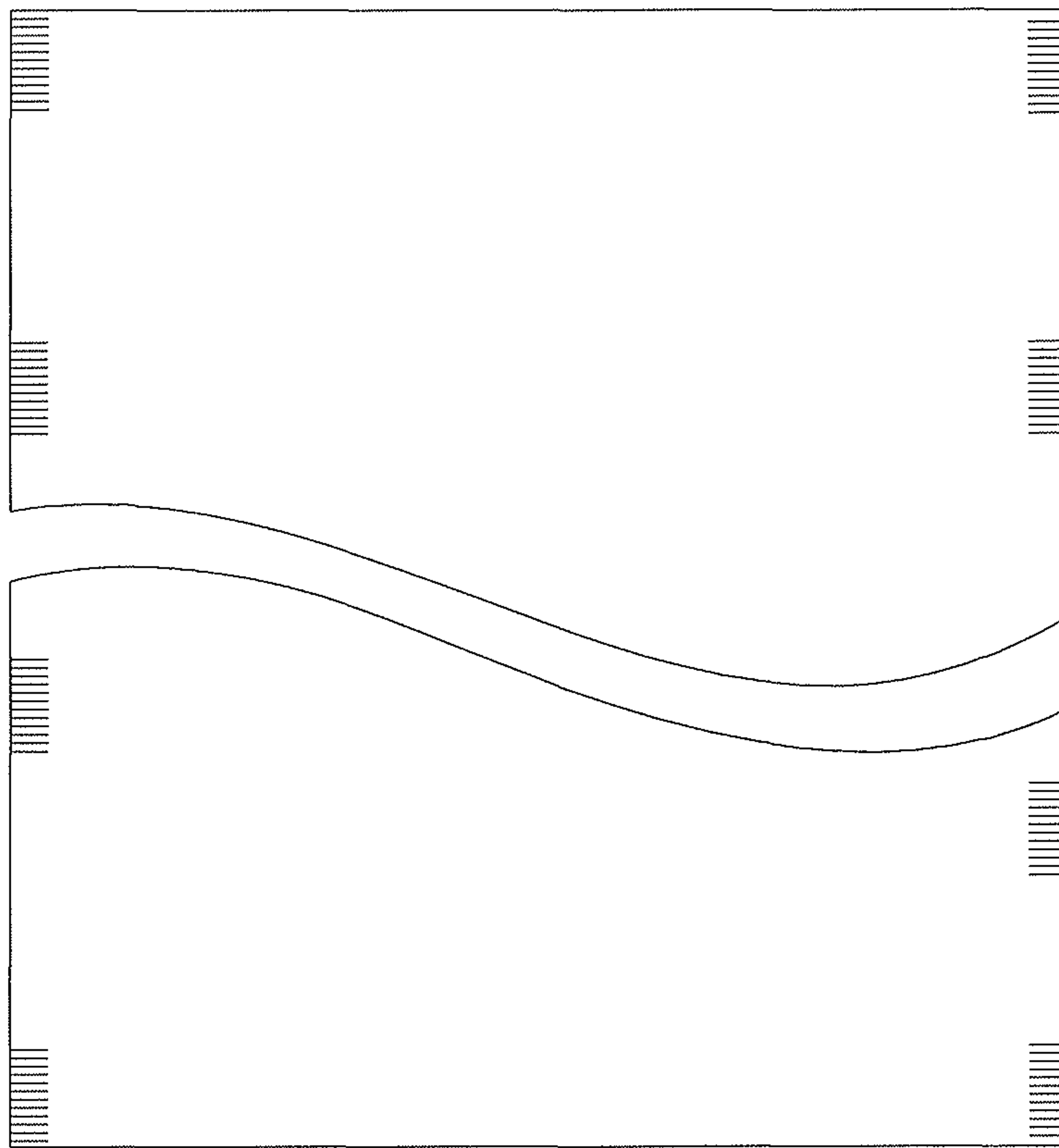

FIG. 4

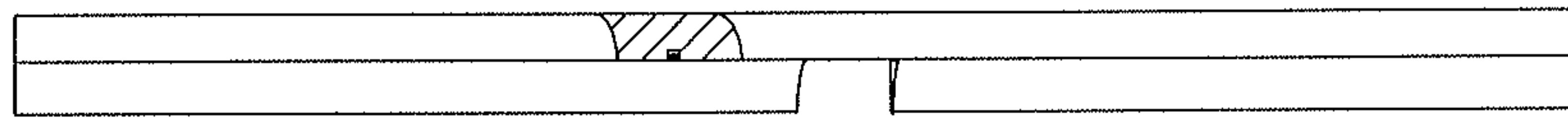

FIG. 5



FIG. 6

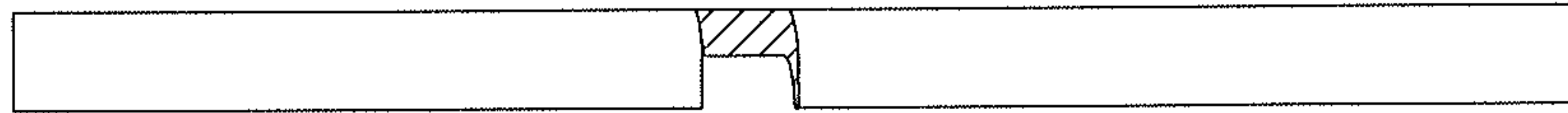

FIG. 7

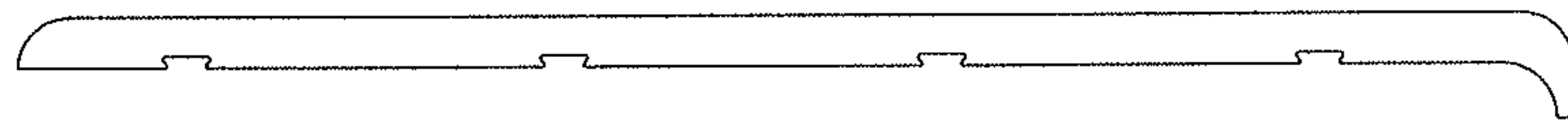

FIG. 8

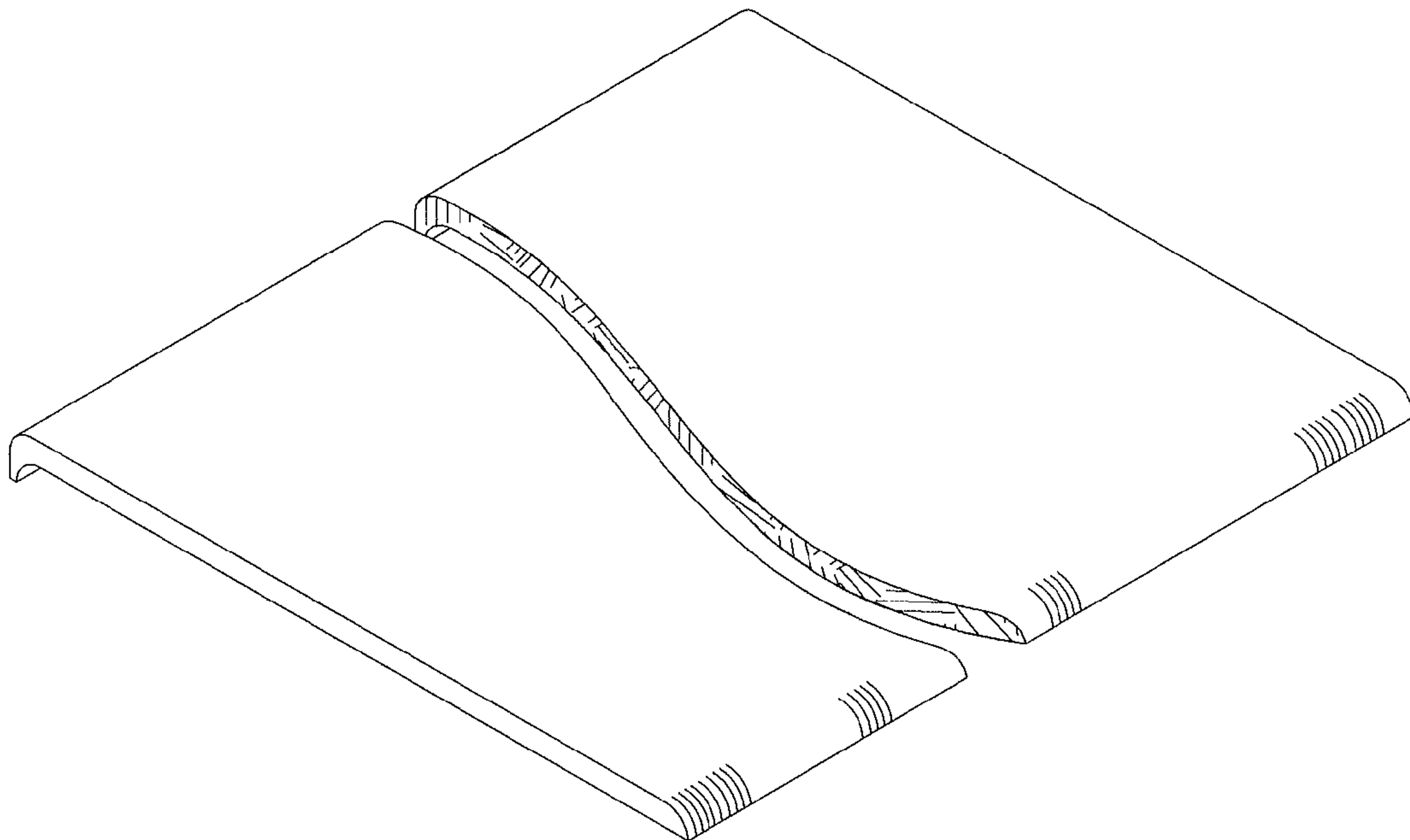

FIG. 9

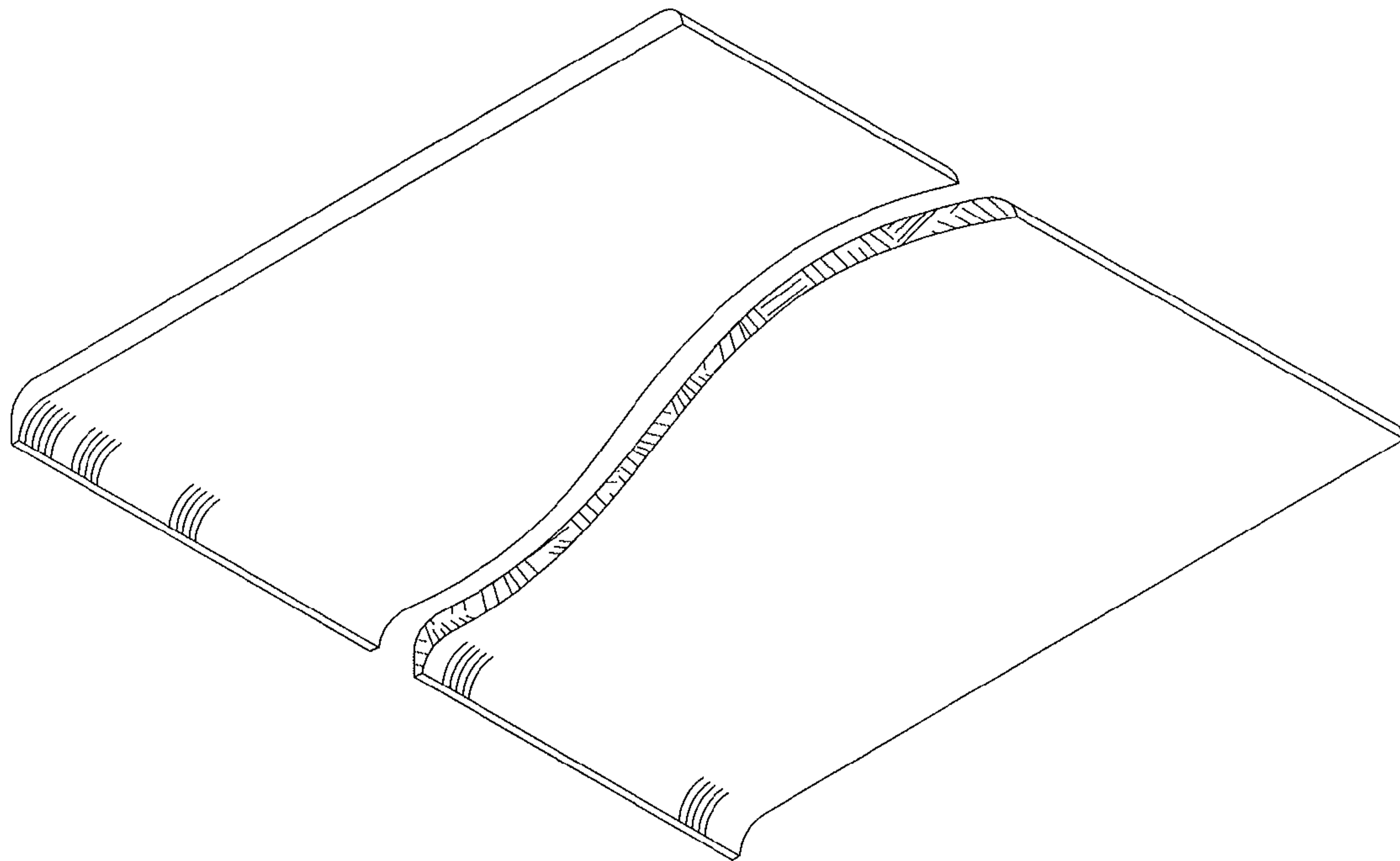

FIG. 10

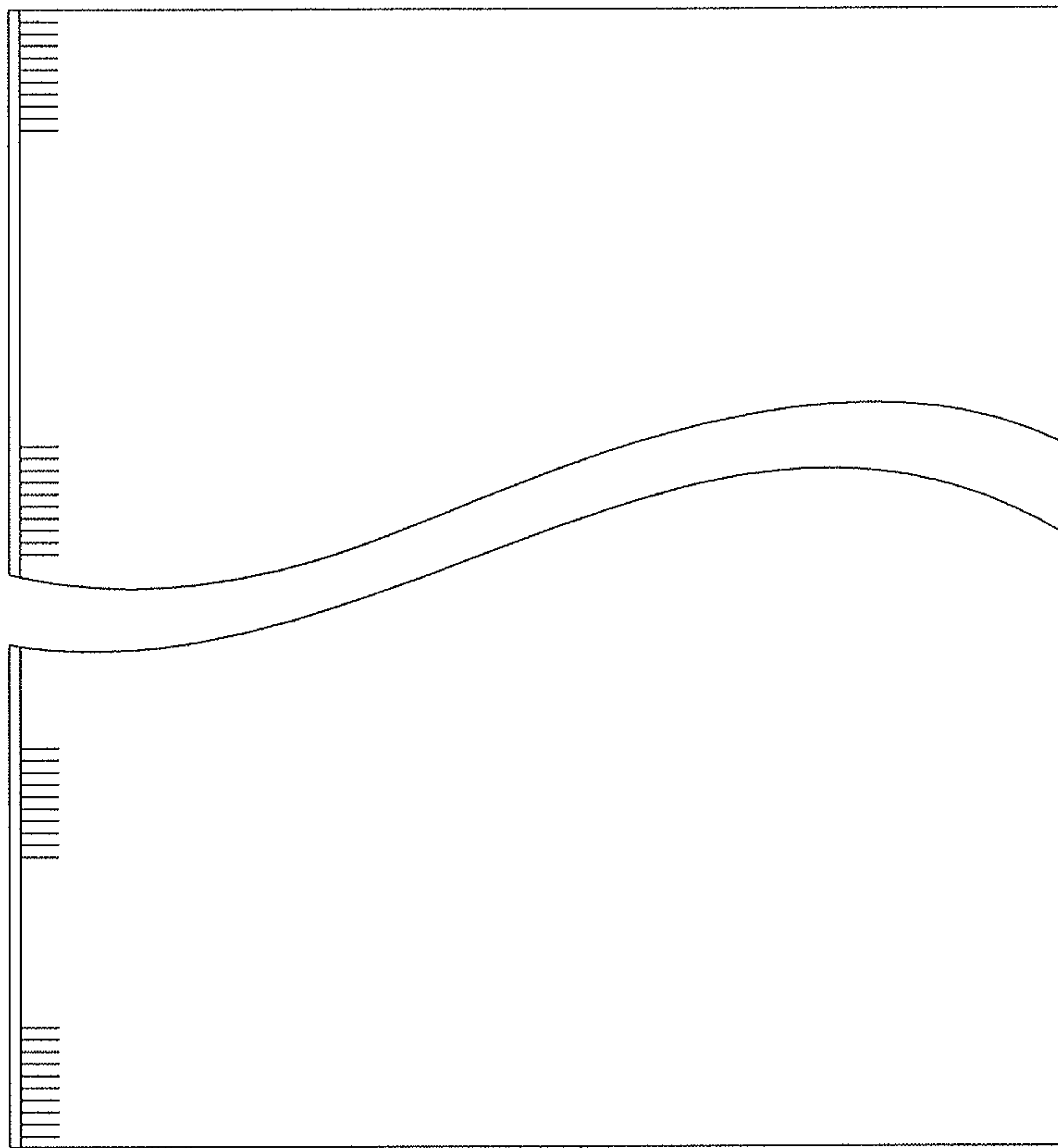

FIG. 11

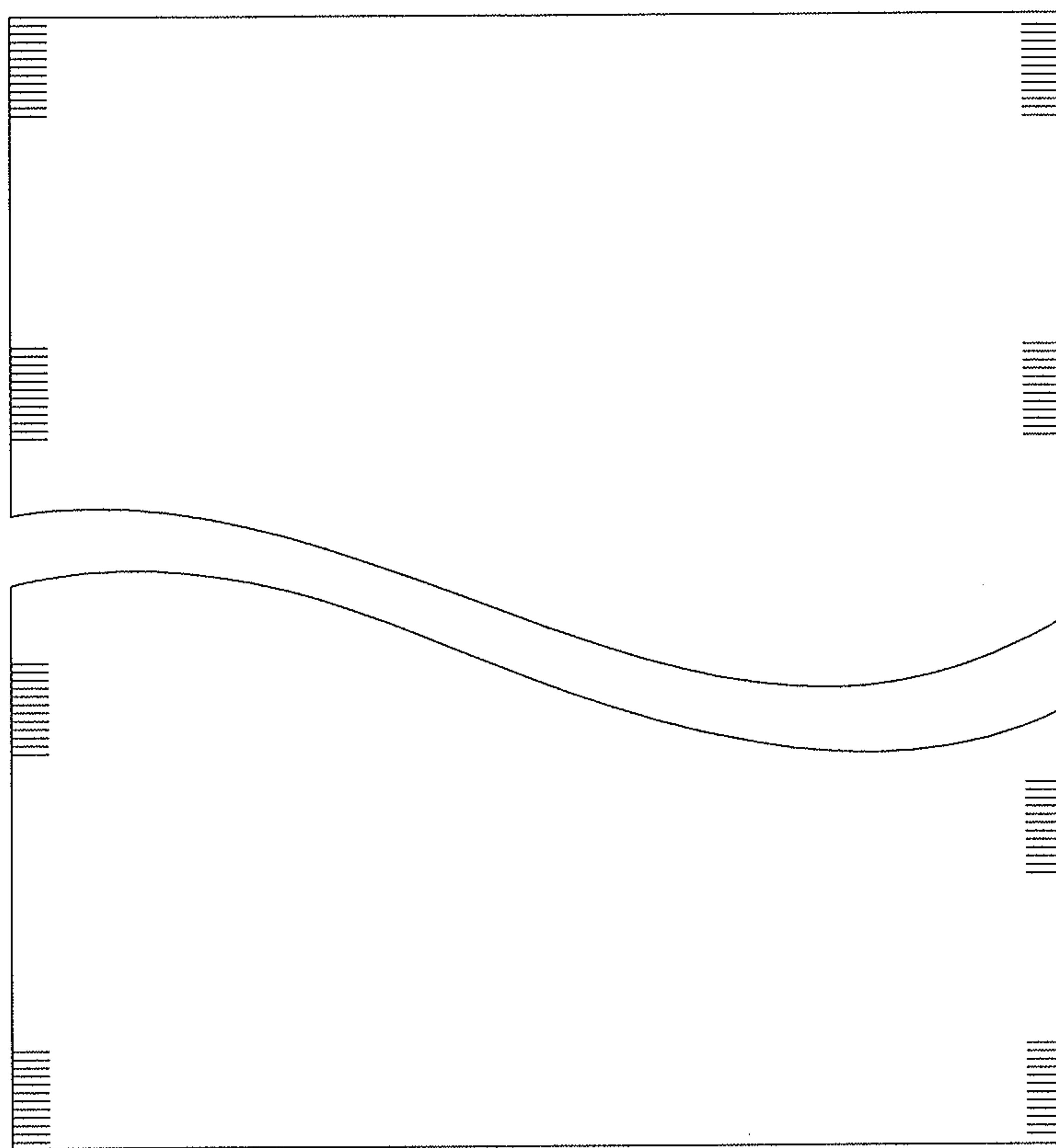

FIG. 12



FIG. 13

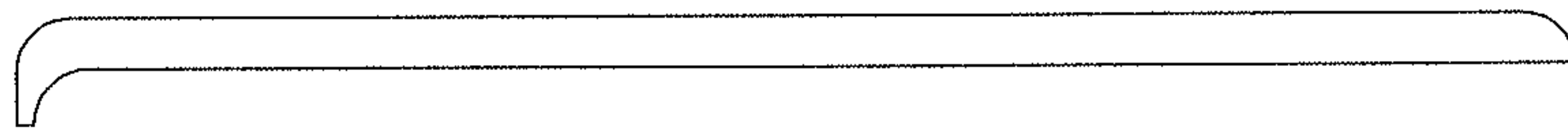

FIG. 14

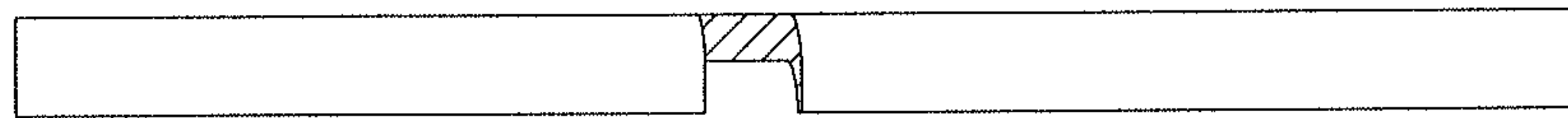

FIG. 15

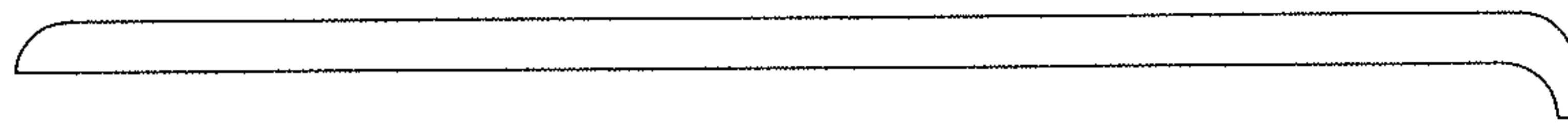

FIG. 16