



US00D705417S

(12) **United States Design Patent**
Lin et al.

(10) **Patent No.:** **US D705,417 S**
(45) **Date of Patent:** **** May 20, 2014**

- (54) **VENTILATION FAN WITH LED**
- (71) Applicants: **Wen-Hsiang Lin**, Taoyuan Hsien (TW);
Long-Sing Ye, Taoyuan Hsien (TW);
Yueh-Shan Lin, Taoyuan Hsien (TW)
- (72) Inventors: **Wen-Hsiang Lin**, Taoyuan Hsien (TW);
Long-Sing Ye, Taoyuan Hsien (TW);
Yueh-Shan Lin, Taoyuan Hsien (TW)

D570,465	S	*	6/2008	Miyake et al.	D23/371
D574,478	S	*	8/2008	Miyake et al.	D23/371
D575,387	S	*	8/2008	Zakula et al.	D23/371
D581,508	S	*	11/2008	Miyake et al.	D23/371
D653,323	S	*	1/2012	Jacak et al.	D23/371
D654,998	S	*	2/2012	Zakula et al.	D23/371
D655,403	S	*	3/2012	Zakula et al.	D23/388
D678,995	S	*	3/2013	Hoshino et al.	D23/388
D681,794	S	*	5/2013	Lin et al.	D23/371
2013/0088855	A1	*	4/2013	Ye et al.	362/96

- (73) Assignee: **Delta Electronics, Inc.** (TW)
- (**) Term: **14 Years**

FOREIGN PATENT DOCUMENTS

TW D150282 11/2012
* cited by examiner

- (21) Appl. No.: **29/445,371**
- (22) Filed: **Feb. 11, 2013**
- (51) **LOC (10) Cl.** **23-04**
- (52) **U.S. Cl.**
USPC **D23/371**
- (58) **Field of Classification Search**
USPC D23/370-385, 411-414, 365, 364, 328,
D23/314, 386-394, 259; 415/60, 66, 68,
415/208.1, 213.1, 214.1; 310/257; 361/695;
126/299 D, 299 R; D26/51, 59, 72, 73;
D32/15, 16; 416/189; D13/179;
454/358-368; D25/199; 285/13, 43,
285/44; 52/58, 219
See application file for complete search history.

Primary Examiner — Susan Bennett Hattan
Assistant Examiner — Janice Hallmark
(74) *Attorney, Agent, or Firm* — Lowe Hauptman & Ham,
LLP

(57) **CLAIM**
The ornamental design for a ventilation fan with LED, as
shown and described.

DESCRIPTION

FIG. 1 is a perspective view of a ventilation fan with LED
showing our new design;
FIG. 2 is a front view thereof;
FIG. 3 is a rear view thereof;
FIG. 4 is a left side view thereof;
FIG. 5 is a right side view thereof;
FIG. 6 is a top view thereof; and,
FIG. 7 is a bottom view thereof.
The broken lines shown represent unclaimed subject matter
and form no part of the claimed design.

- (56) **References Cited**
U.S. PATENT DOCUMENTS
D510,996 S * 10/2005 Vladika D23/385
D535,431 S * 1/2007 Roland D26/118
D567,352 S * 4/2008 Hollingsworth et al. D23/388

1 Claim, 5 Drawing Sheets

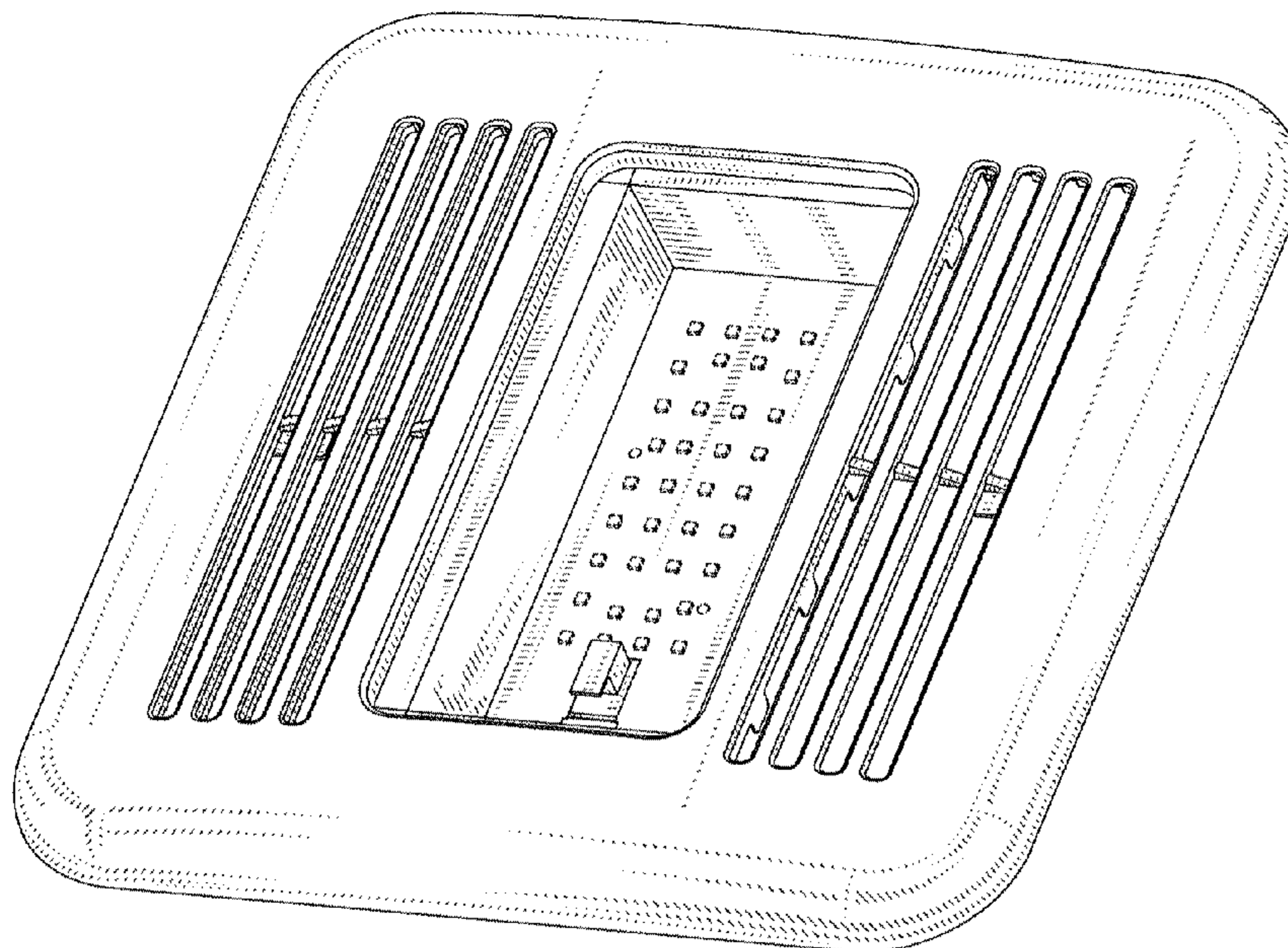

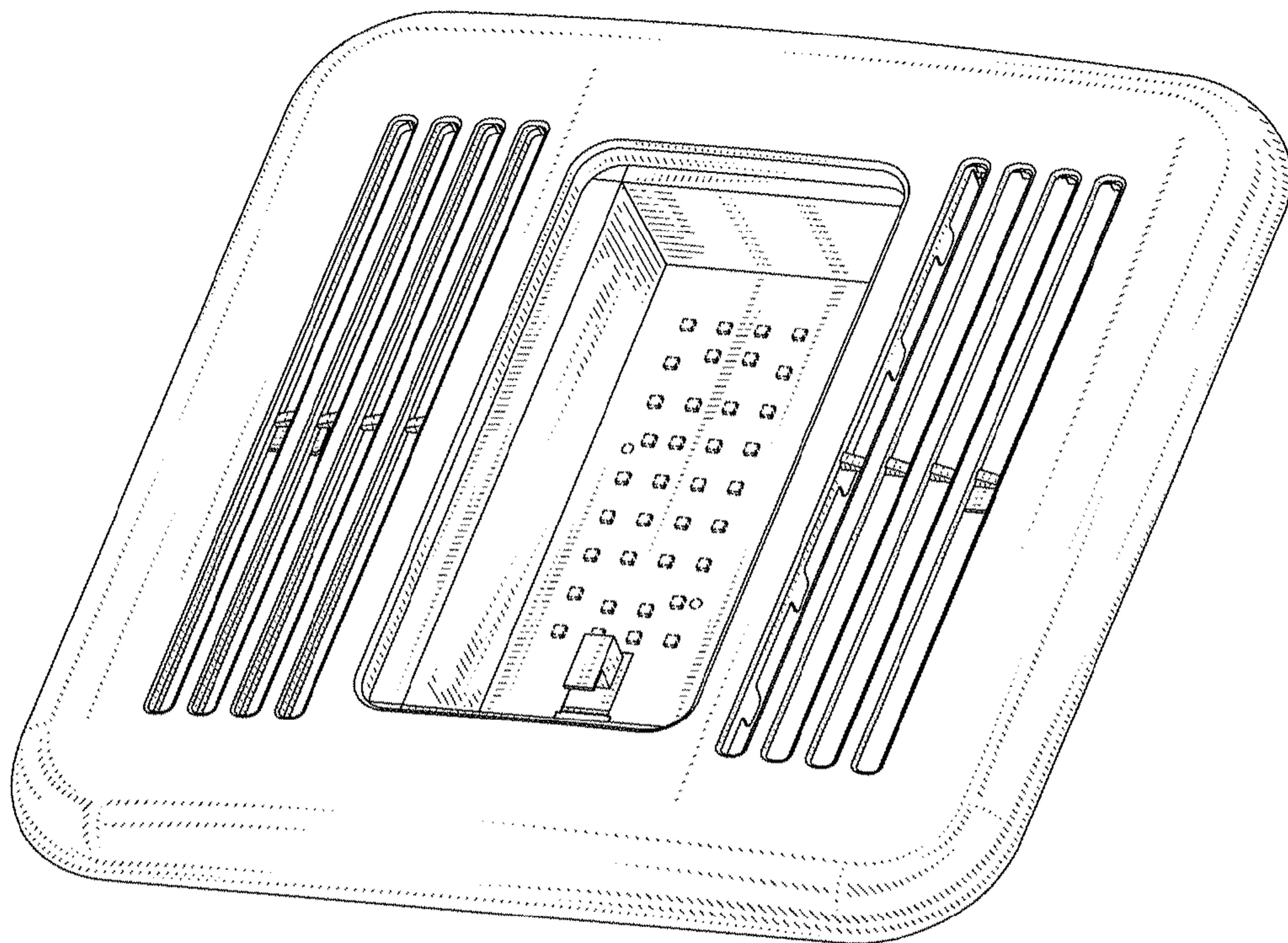

FIG. 1

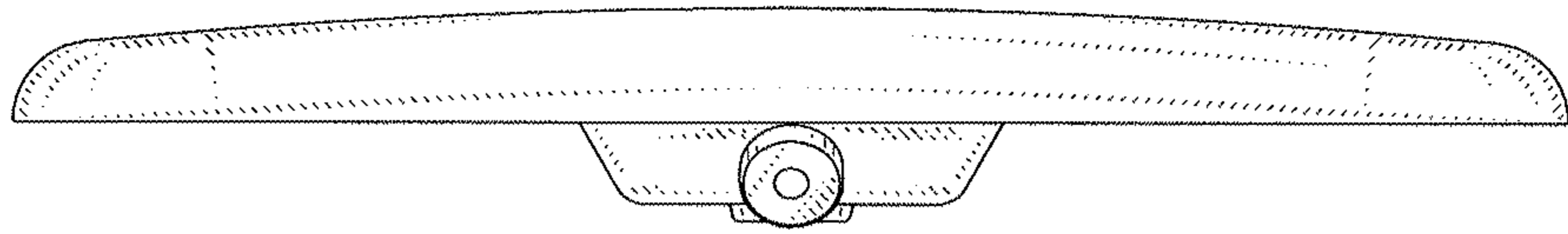

FIG. 2

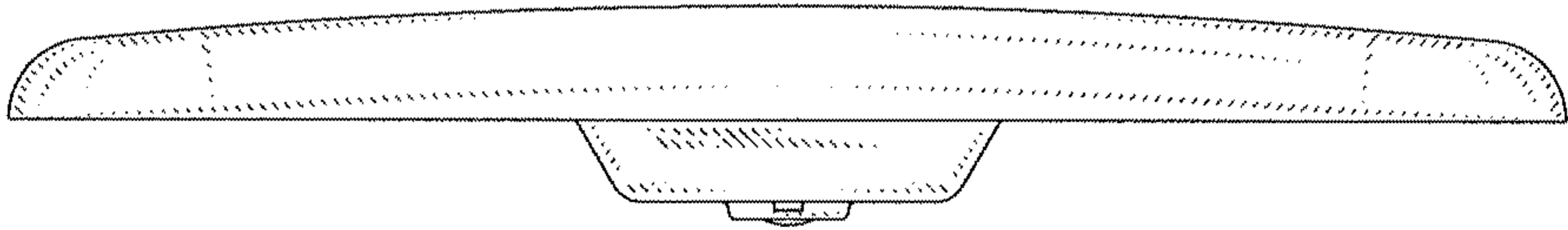

FIG. 3

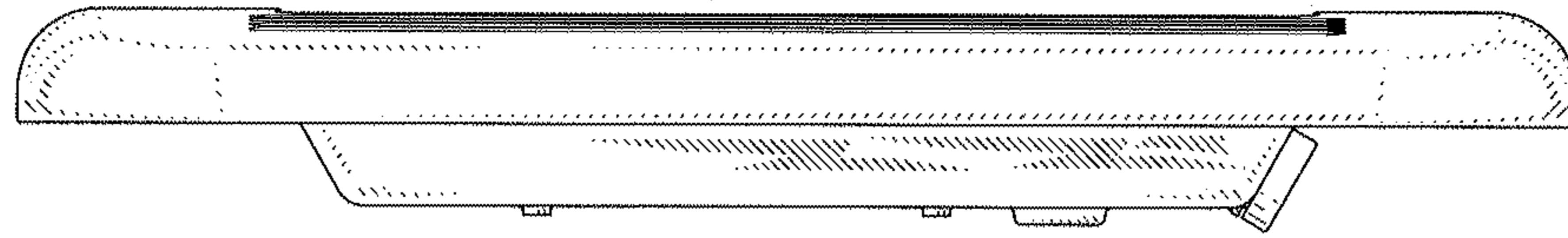

FIG. 4

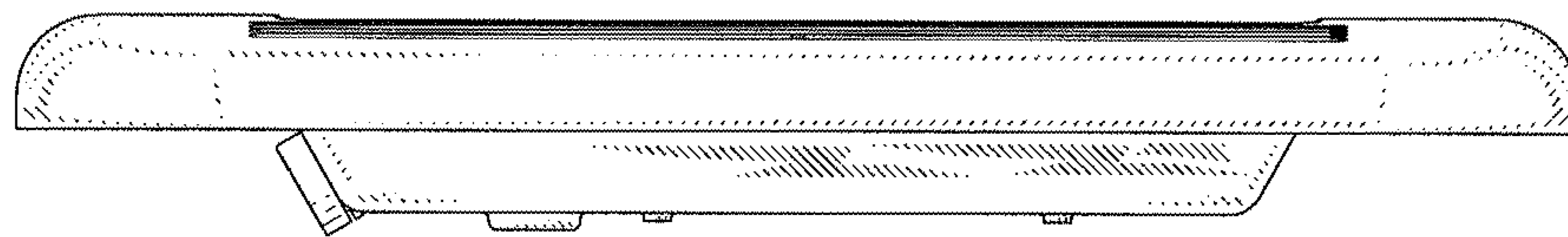

FIG. 5

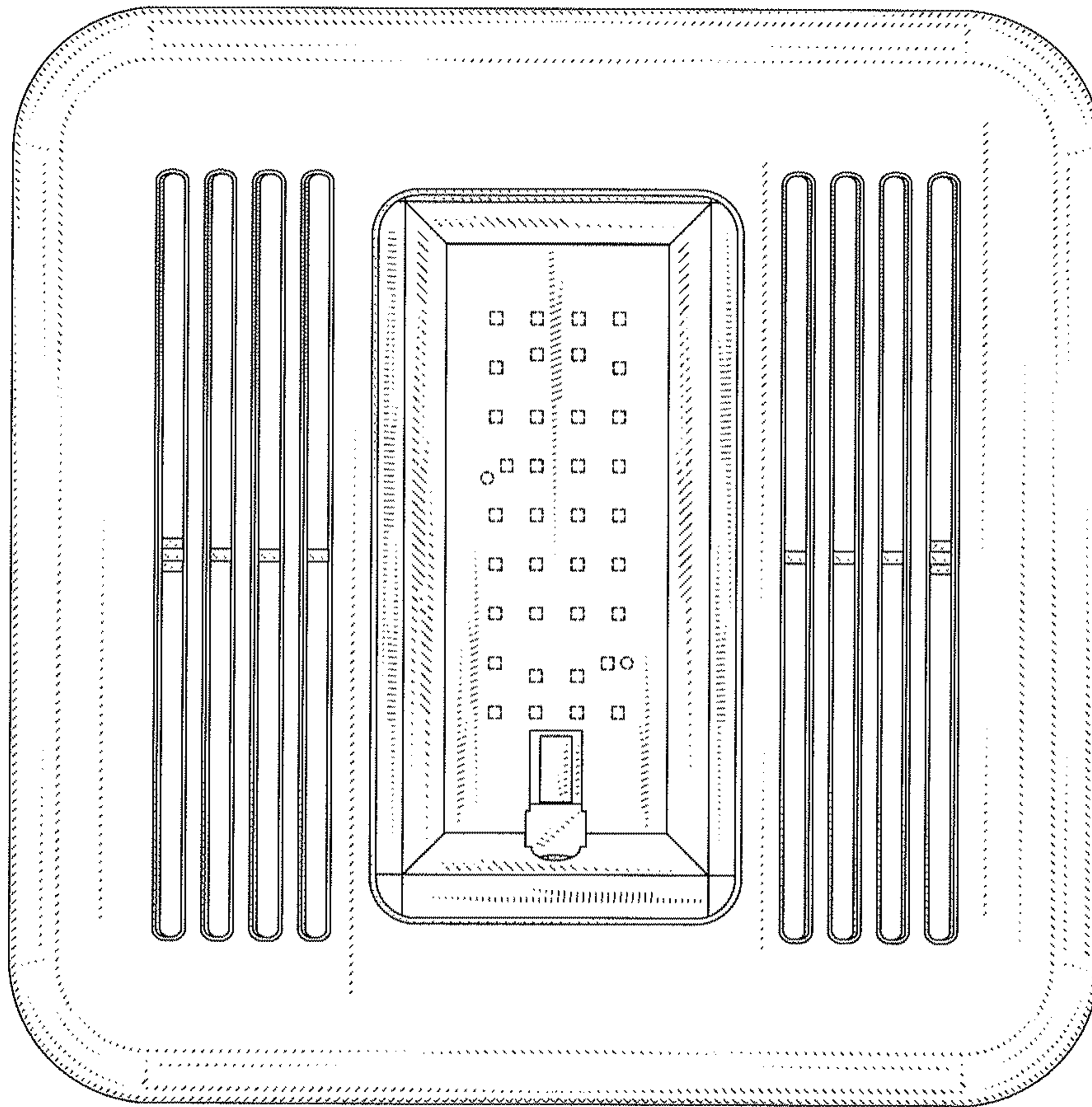

FIG. 6

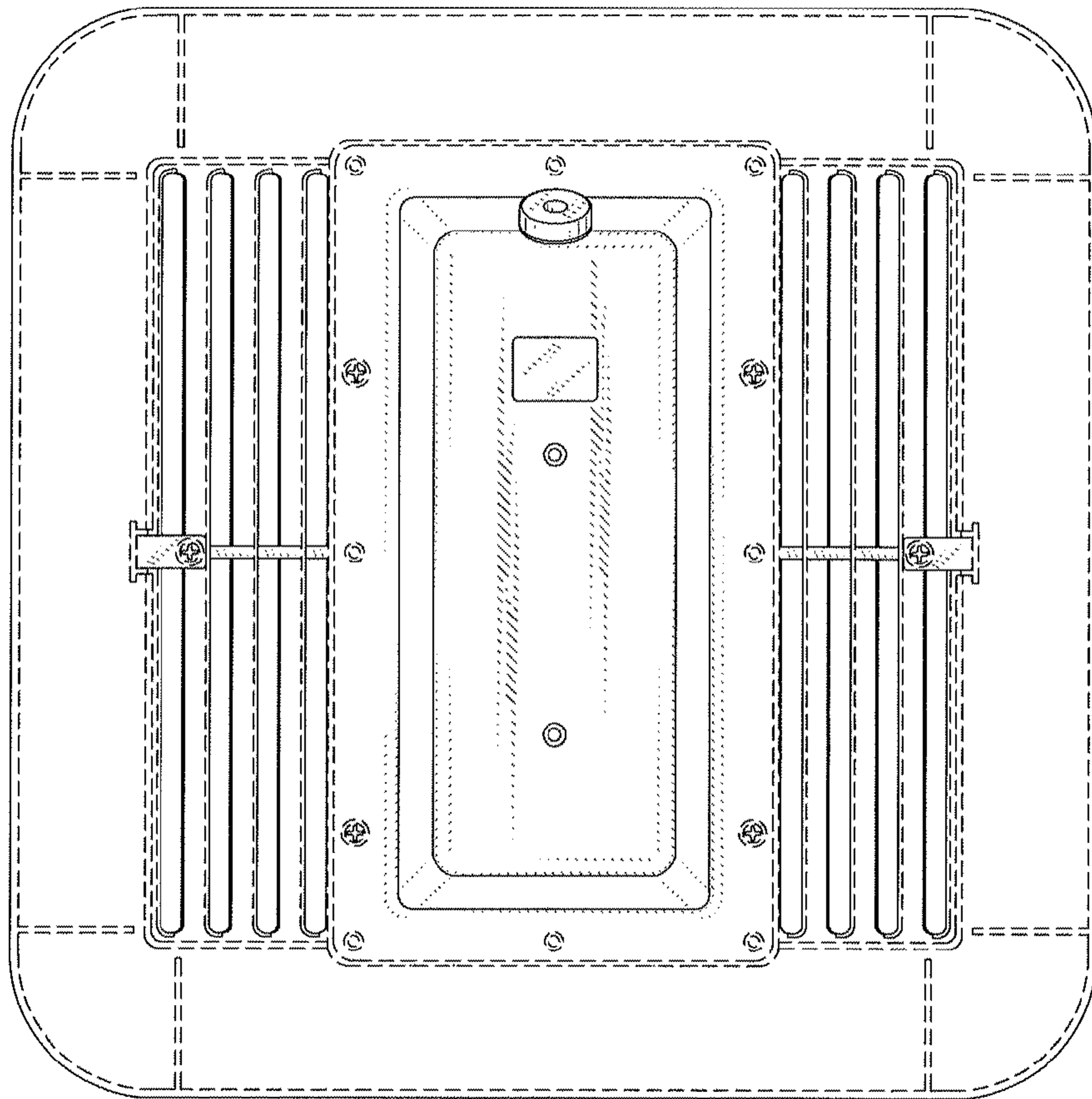

FIG. 7