



US00D705277S

(12) **United States Design Patent**
Carleton

(10) **Patent No.:** **US D705,277 S**

(45) **Date of Patent:** **** May 20, 2014**

(54) **SEWING MACHINE BOBBIN ORGANIZER**

(71) Applicant: **Chris Carleton**, Georgetown, TX (US)

(72) Inventor: **Chris Carleton**, Georgetown, TX (US)

(**) Term: **14 Years**

(21) Appl. No.: **29/444,178**

(22) Filed: **Jan. 28, 2013**

(51) **LOC (10) Cl.** **21-03**

(52) **U.S. Cl.**
USPC **D15/78**

(58) **Field of Classification Search**
USPC D15/66-78, 138, 199; 112/279;
242/118-125.3

See application file for complete search history.

(56) **References Cited**

U.S. PATENT DOCUMENTS

2,592,516	A *	4/1952	Hirsch et al.	112/279
D250,338	S *	11/1978	LaPierre	D15/78
D313,605	S *	1/1991	Saito et al.	D15/78
D399,857	S *	10/1998	Kanemichi	D15/138
7,100,856	B2	9/2006	Murphy, Jr.	
D595,325	S *	6/2009	Miyashita et al.	D15/143

D611,516	S *	3/2010	Davison et al.	D15/199
D649,564	S *	11/2011	Nishi	D15/72
2010/0107948	A1	5/2010	Totsu	

OTHER PUBLICATIONS

<http://napo.newengland.com/blog/?p=431>. Posted Jul. 14, 2011.
<http://andover.patch.com/blog?posts/tip-for-sewers-keep-bobbins-from-unraveling-when-not-in-use>. Posted Dec. 8, 2011.
<http://www.amazon.com/Brother-SABOBCLIP-Bobbin-Clips-Pack/dp/B001VT7NZY>. Accessed on Aug. 2, 2012.

* cited by examiner

Primary Examiner — Mitchell Siegel

(74) *Attorney, Agent, or Firm* — Robert C. Montgomery; Montgomery Patent & Design

(57) **CLAIM**

The ornamental design for a sewing machine bobbin organizer, as shown and described.

DESCRIPTION

FIG. 1 is a perspective view of a sewing machine bobbin organizer, showing my new design; FIG. 2 is a front view thereof; FIG. 3 is a rear view thereof; FIG. 4 is a left hand view thereof; FIG. 5 is a right hand view thereof; FIG. 6 is a top view thereof; and, FIG. 7 is a bottom view thereof.

1 Claim, 6 Drawing Sheets

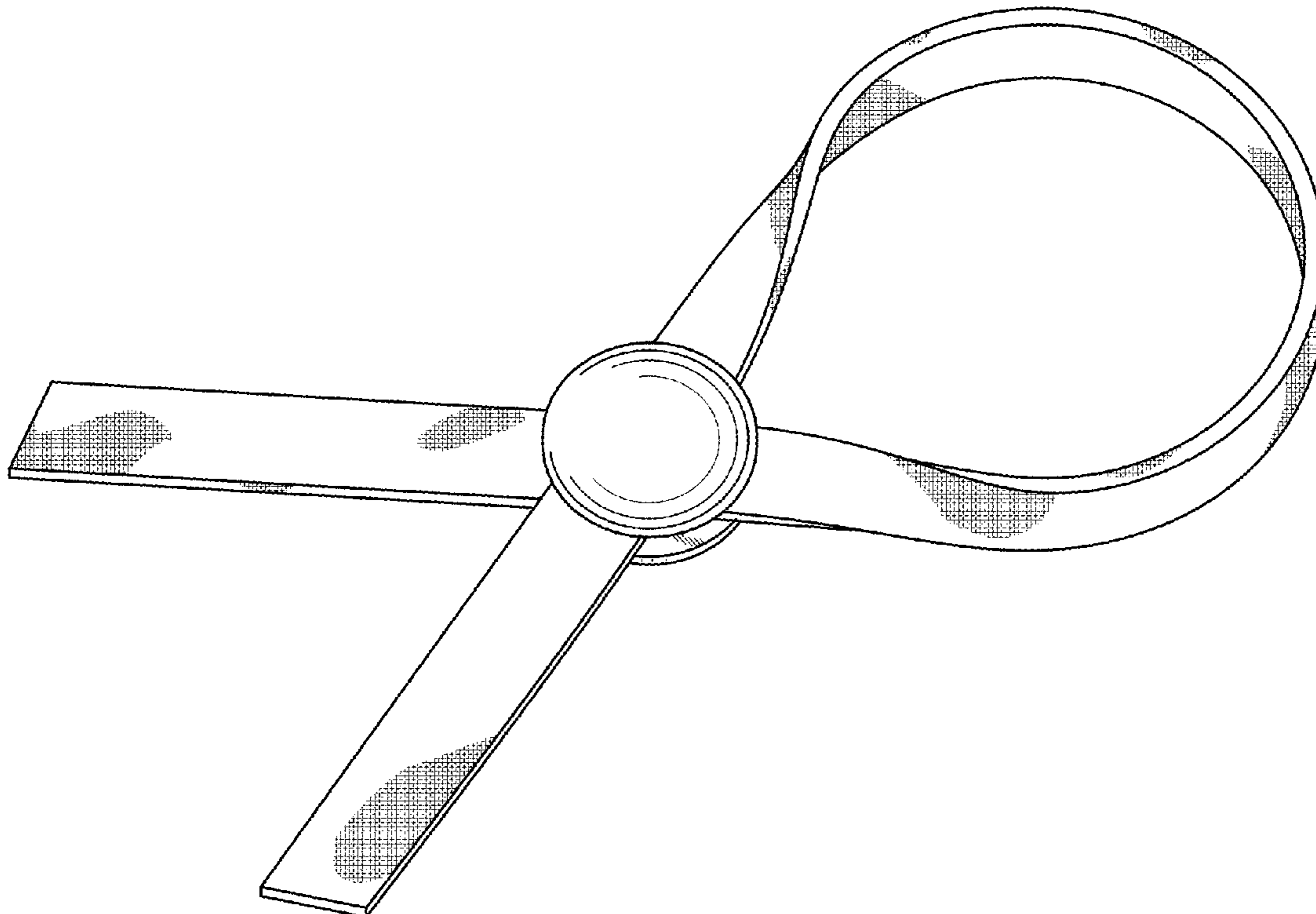

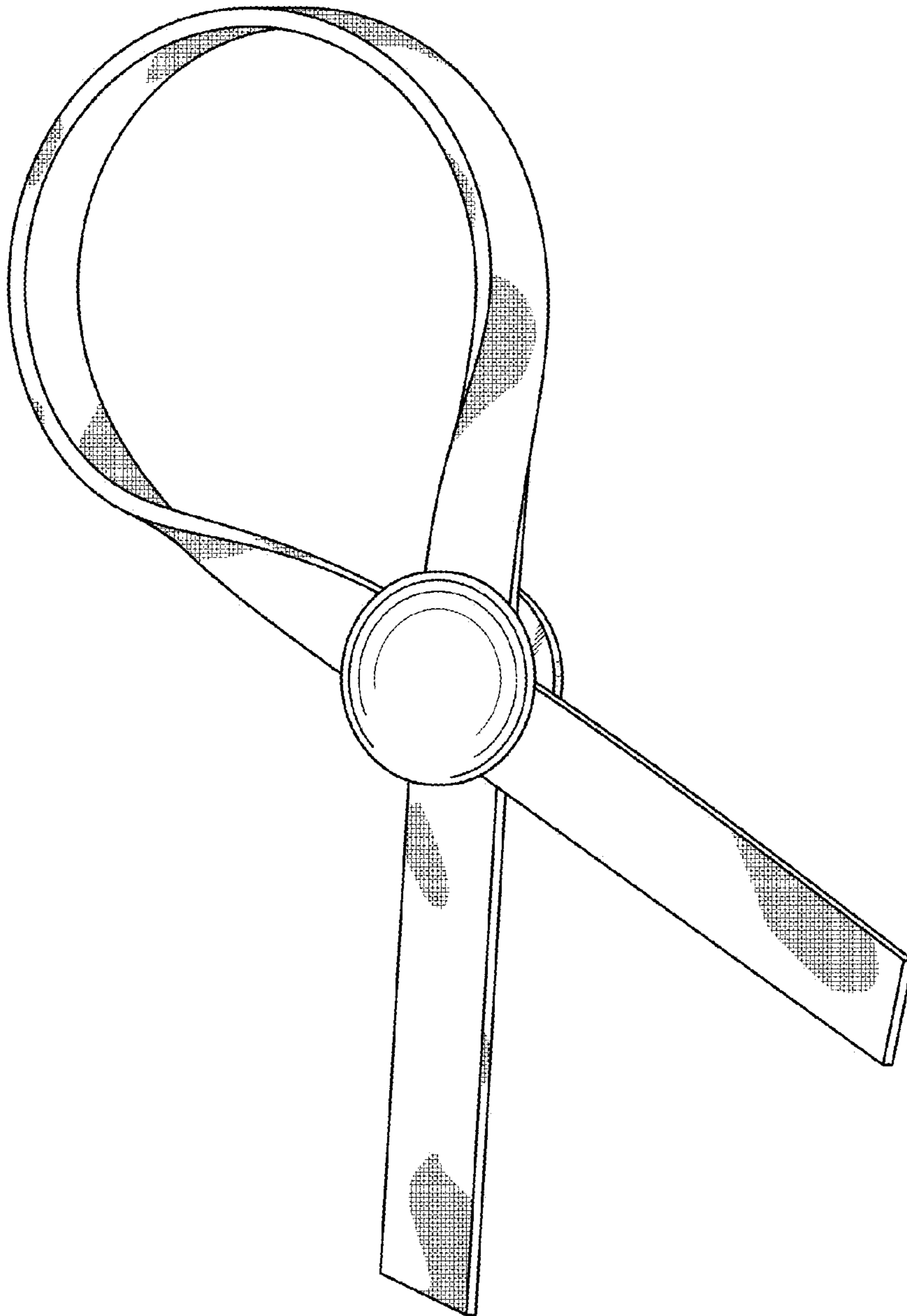

Fig. 1

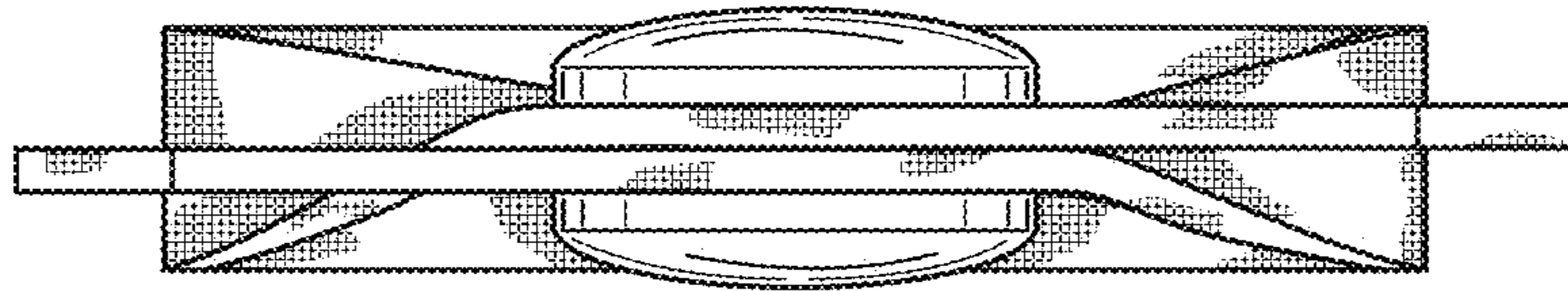

Fig. 2

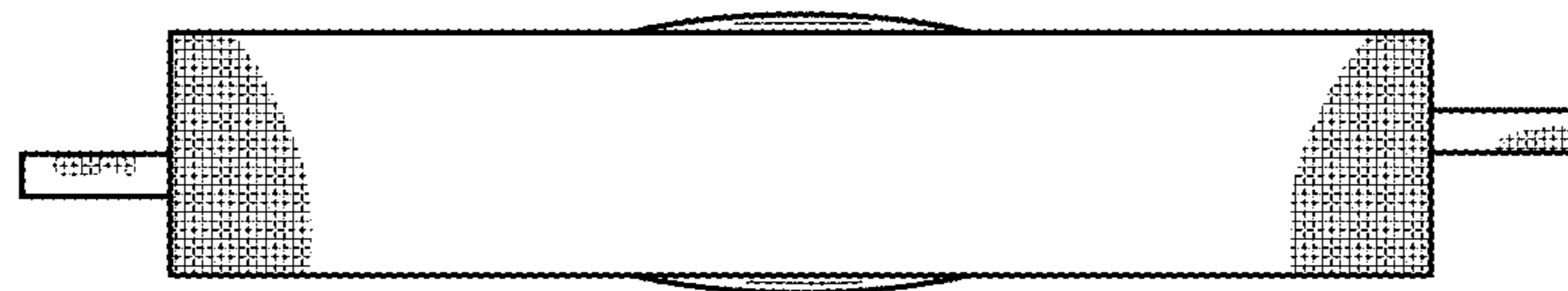

Fig. 3

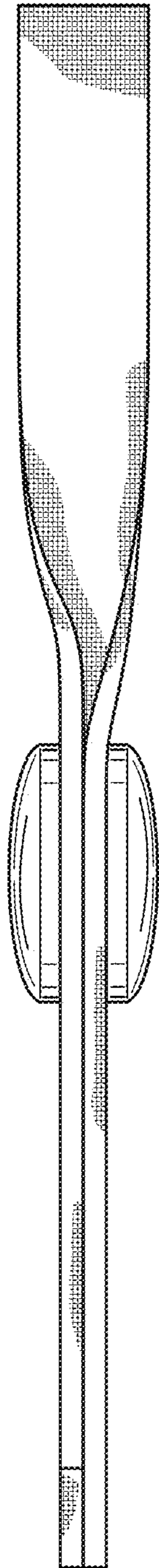

Fig. 4

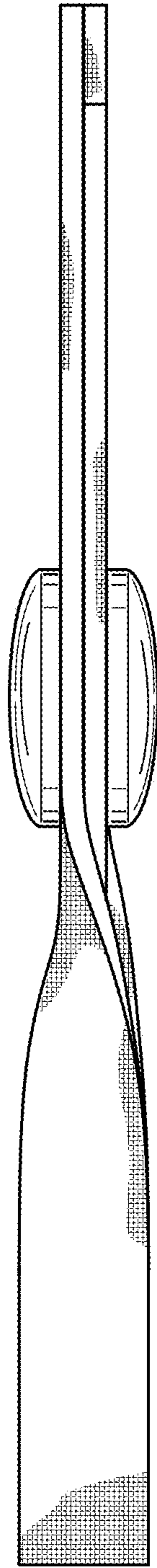

Fig. 5

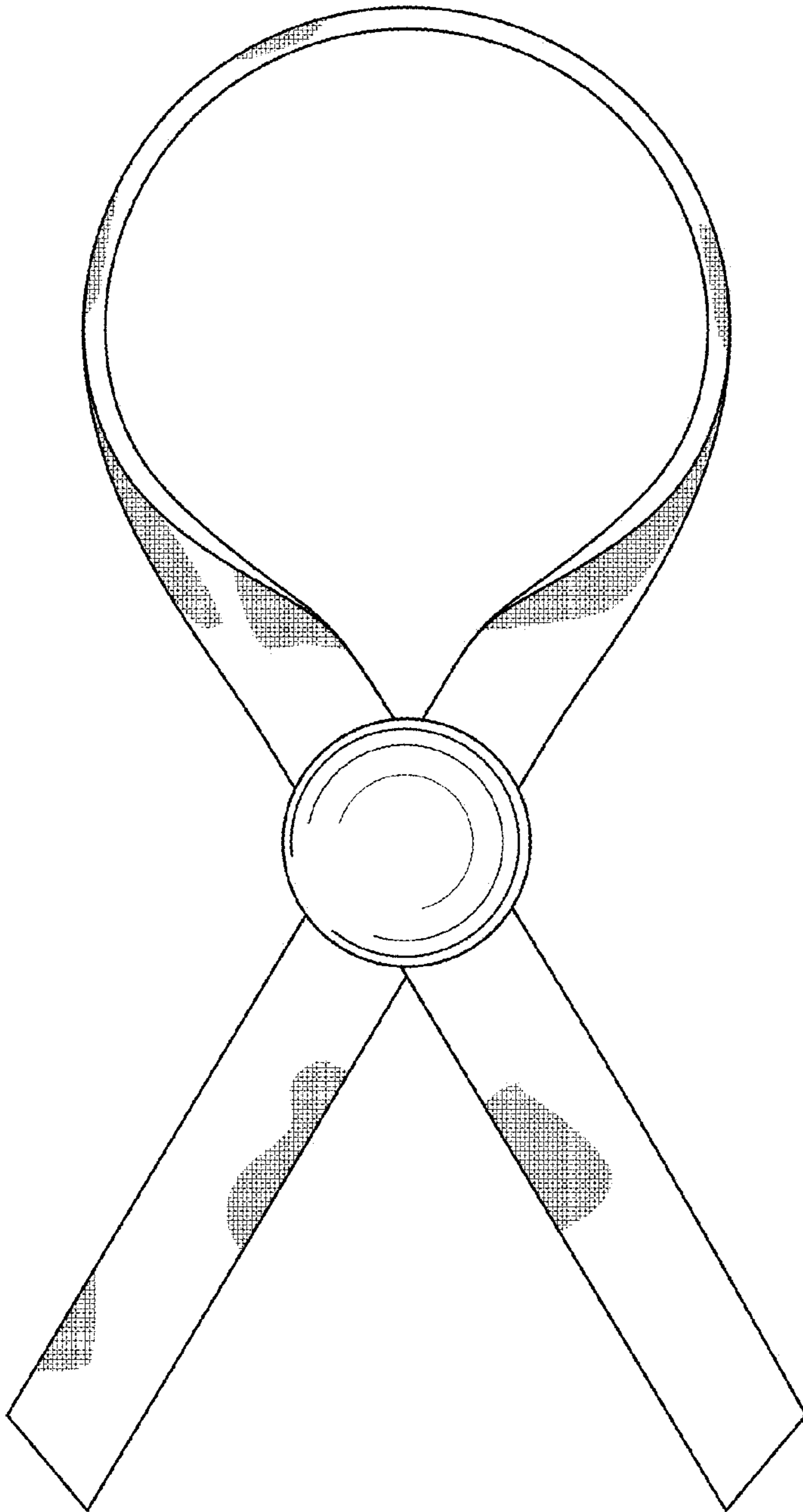

Fig. 6

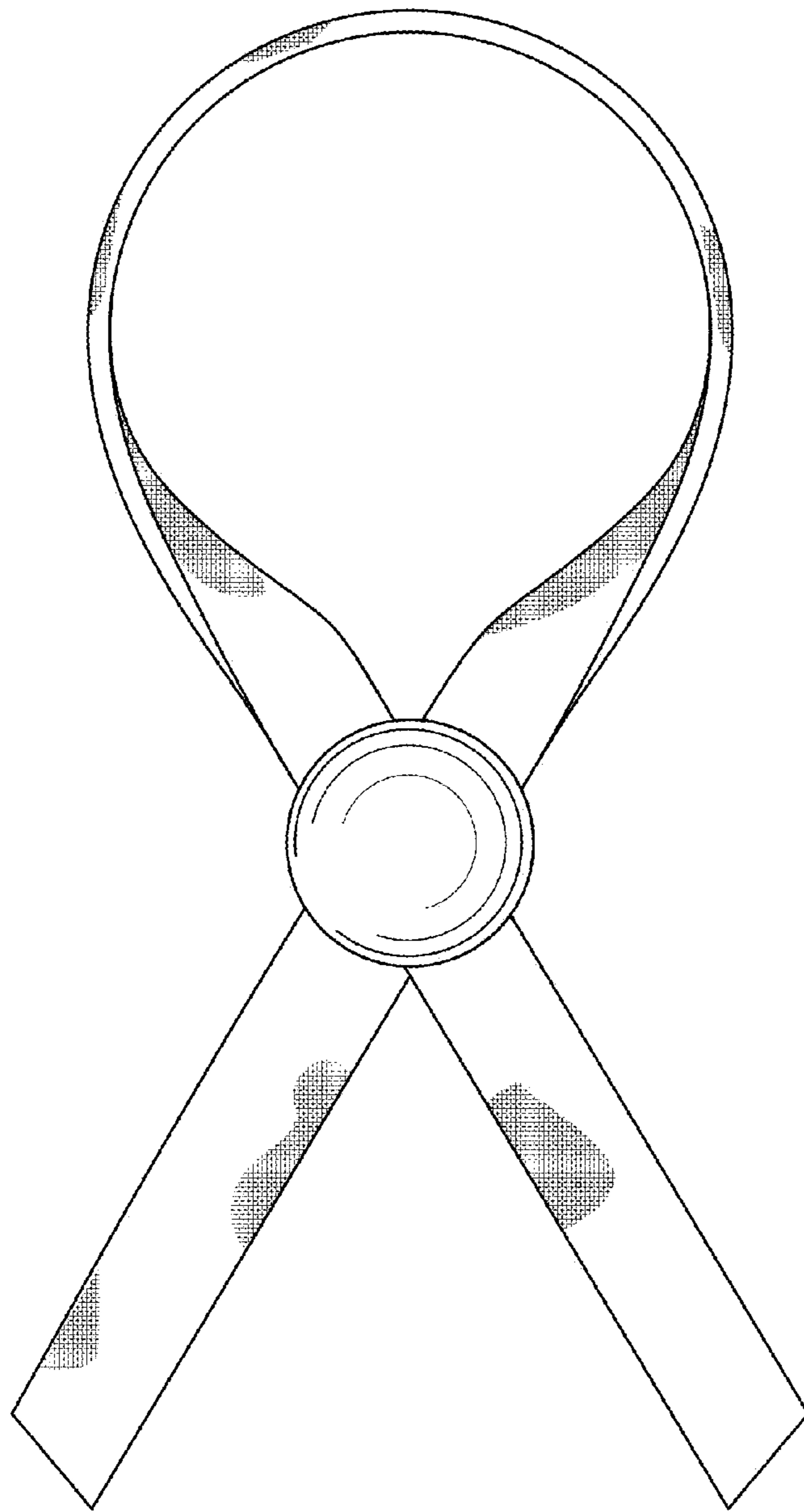

Fig. 7