



US00D705214S

(12) **United States Design Patent**
Lee et al.

(10) **Patent No.:** **US D705,214 S**
(45) **Date of Patent:** **** May 20, 2014**

(54) **NOTEBOOK COMPUTER**

(71) Applicant: **Samsung Electronics Co., Ltd.**,
Suwon-si (KR)

(72) Inventors: **Dong-Seok Lee**, Seoul (KR);
Son-Young Lee, Seoul (KR)

(73) Assignee: **Samsung Electronics Co., Ltd.**,
Suwon-si (KR)

(**) Term: **14 Years**

(21) Appl. No.: **29/440,638**

(22) Filed: **Dec. 24, 2012**

(30) **Foreign Application Priority Data**

Jul. 6, 2012 (KR) 30-2012-0033080

(51) **LOC (10) Cl.** **14-02**

(52) **U.S. Cl.**
USPC **D14/315**

(58) **Field of Classification Search**
USPC D14/315-327, 439; D18/1, 2, 7, 11;
235/145 A, 145 R; 341/22, 23; 345/104,
345/156, 168, 169, 173; 361/679.08,
361/679.09, 679.11, 679.26, 679.27;
16/367

See application file for complete search history.

(56) **References Cited**

U.S. PATENT DOCUMENTS

7,164,578	B2 *	1/2007	Wang et al.	361/679.08
D631,472	S *	1/2011	Kawase et al.	D14/327
D633,488	S *	3/2011	Kim et al.	D14/315
D652,417	S *	1/2012	Lee et al.	D14/315
D664,538	S *	7/2012	Ryu et al.	D14/327
D671,539	S *	11/2012	Kim et al.	D14/318
2005/0063145	A1 *	3/2005	Homer et al.	361/683
2005/0083644	A1 *	4/2005	Song	361/683
2006/0038795	A1 *	2/2006	Lee	345/173

* cited by examiner

Primary Examiner — Freda S Nunn

(74) *Attorney, Agent, or Firm* — NSIP Law

(57) **CLAIM**

The ornamental design for a notebook computer, as shown and described.

DESCRIPTION

FIG. 1 is a top perspective view of a notebook computer; FIG. 2 is a front view of the notebook computer of FIG. 1; FIG. 3 is a rear view of the notebook computer of FIG. 1; FIG. 4 is a left-side view of the notebook computer of FIG. 1; FIG. 5 is a right-side view of the notebook computer of FIG. 1; FIG. 6 is a top plan view of the notebook computer of FIG. 1; and, FIG. 7 is a bottom plan view of the notebook computer of FIG. 1. Features shown in broken lines in FIGS. 1, 2, 3, 4, 5, and 7, form no part of the claimed design.

1 Claim, 5 Drawing Sheets

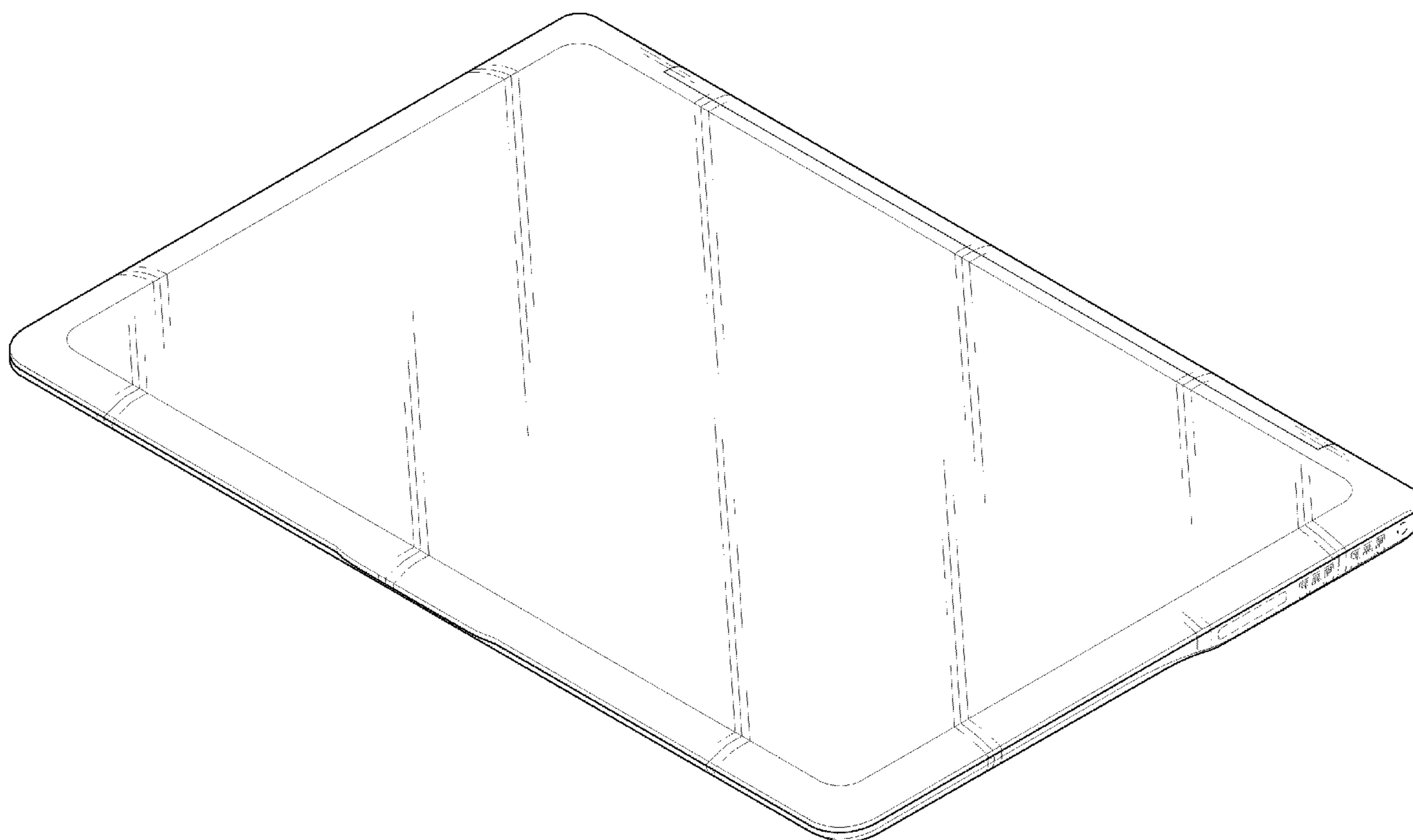

FIG. 1

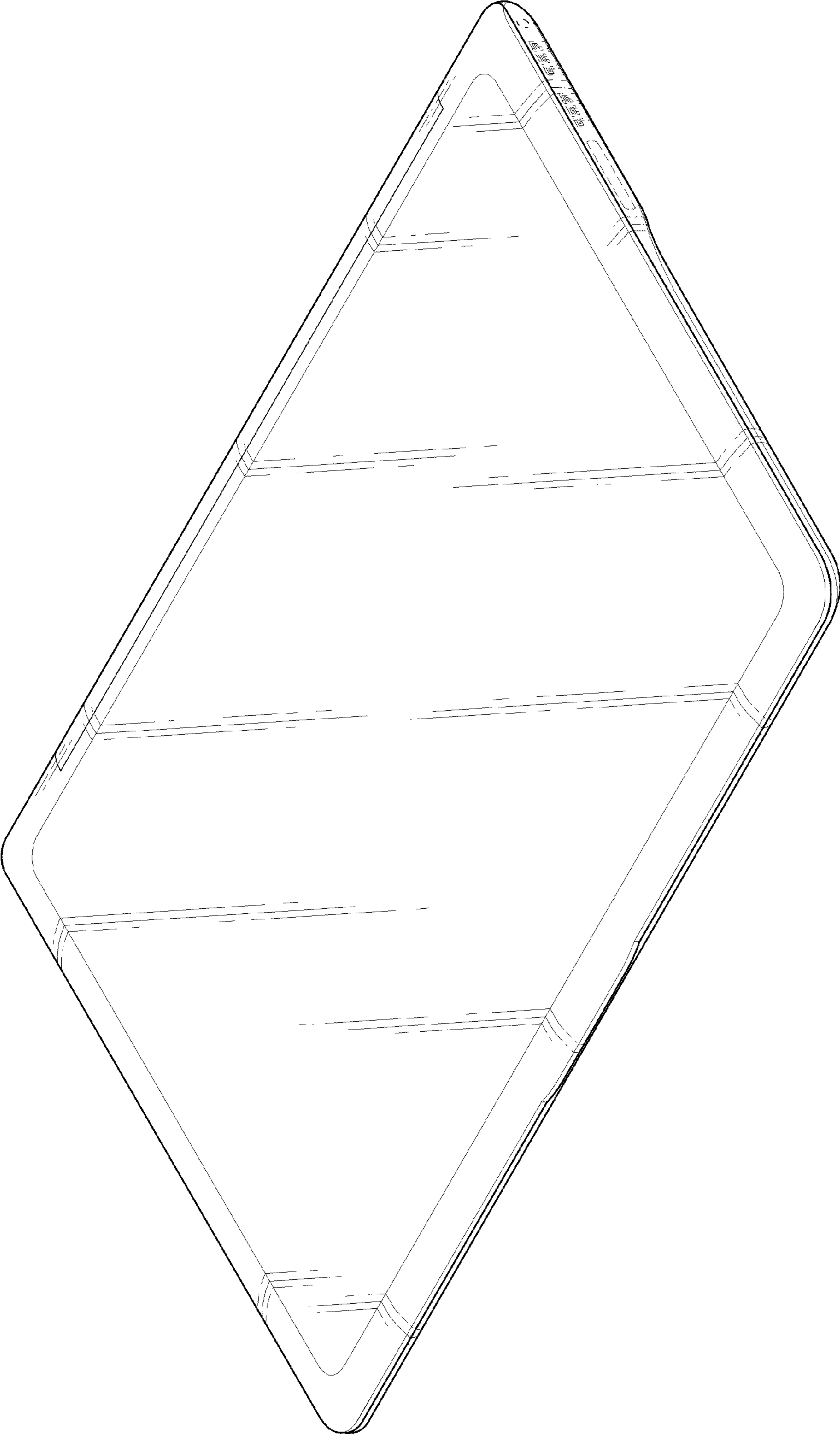

FIG. 2

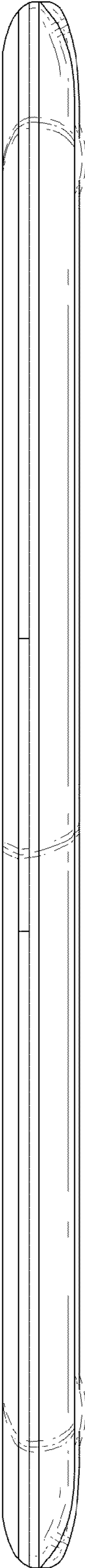

FIG. 3

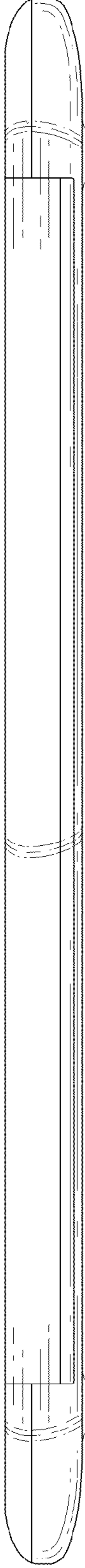

FIG. 4

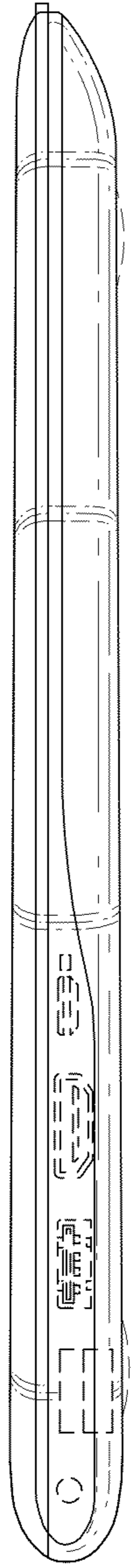

FIG. 5

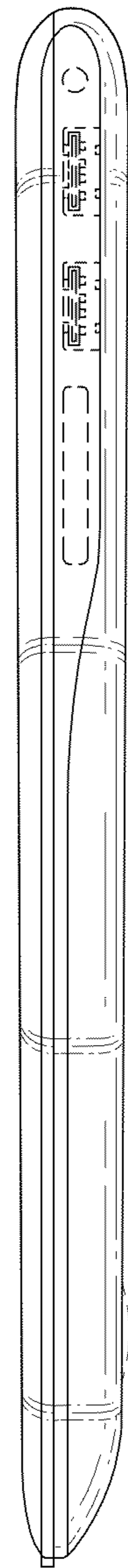

FIG. 6

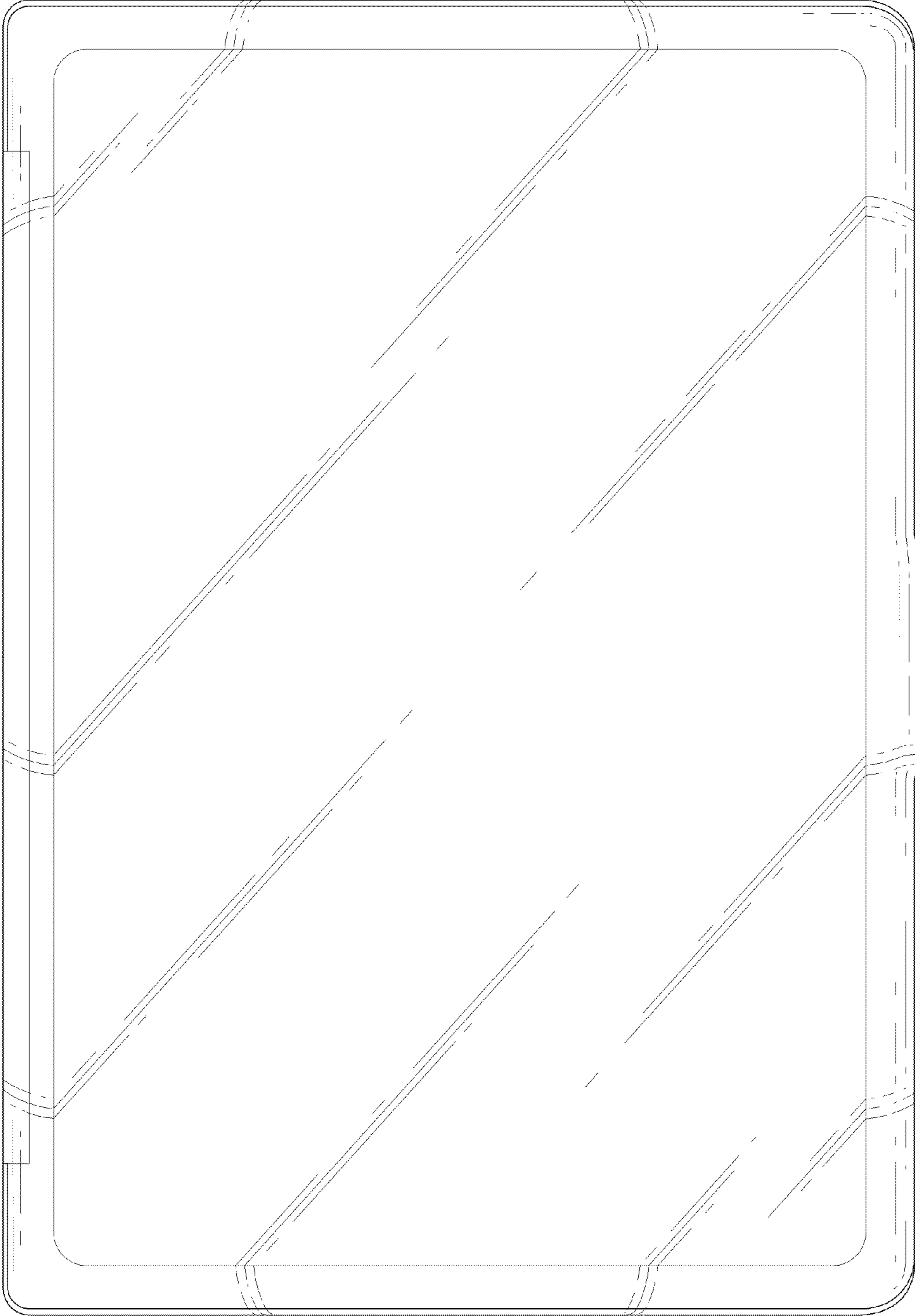

FIG. 7

