



US00D705181S

(12) **United States Design Patent**
Hussell et al.

(10) **Patent No.:** **US D705,181 S**
(45) **Date of Patent:** **** May 20, 2014**

(54) **LIGHT EMITTING DEVICE COMPONENT**

D573,553 S 7/2008 Uemoto et al.
D573,731 S 7/2008 Uemoto
D576,576 S 9/2008 Shida et al.

(75) Inventors: **Christopher P. Hussell**, Cary, NC (US);
Erin R. F. Welch, Chapel Hill, NC (US);
Kurt S. Wilcox, Libertyville, IL (US);
Jesse Colin Reiherzer, Wake Forest, NC (US)

(Continued)

FOREIGN PATENT DOCUMENTS

(73) Assignee: **Cree, Inc.**, Durham, NC (US)

CN ZL 201230472866.4 5/2013
EP 2 643 861 10/2013

(Continued)

(**) Term: **14 Years**

OTHER PUBLICATIONS

(21) Appl. No.: **29/412,166**

Taiwanese Search Report for Application No. 102300059 dated Apr. 17, 2013.

(22) Filed: **Jan. 31, 2012**

(Continued)

Related U.S. Application Data

(63) Continuation-in-part of application No. 29/404,913, filed on Oct. 26, 2011.

Primary Examiner — Selina Sikder

(51) **LOC (10) Cl.** **13-03**

(74) *Attorney, Agent, or Firm* — Jenkins, Wilson, Taylor & Hunt, P.A.

(52) **U.S. Cl.**

USPC **D13/180**

(58) **Field of Classification Search**

USPC D13/180; D26/1; 257/79, 80, 81, 88,
257/89, 95, 98, 99, 100, E33.058; 313/483,
313/498, 500; 362/555, 800

See application file for complete search history.

(57)

CLAIM

The ornamental design for a light emitting device component, as shown and described.

DESCRIPTION

FIG. 1 is a perspective view of a light emitting device component showing the design;
FIG. 2 is a top view thereof;
FIG. 3 is a bottom view thereof;
FIG. 4 is a first side view thereof;
FIG. 5 is a second side view thereof, which is an opposing view of that shown in FIG. 4;
FIG. 6 is a third side view thereof; and,
FIG. 7 is a fourth side view thereof, which is an opposing view of that shown in FIG. 6.

The dashed broken lines are for illustrative purposes only. The dot-dashed broken lines represent boundaries of the claimed design. The broken lines form no part of the claimed design.

(56) **References Cited**

U.S. PATENT DOCUMENTS

34,861 A	4/1862	Knowlton et al.
4,855,194 A	8/1989	Wright
4,946,547 A	8/1990	Palmour
5,200,022 A	4/1993	Kong
RE34,861 E	2/1995	Davis et al.
6,548,832 B1	4/2003	Sakamoto et al.
7,055,987 B2	6/2006	Staufert
D528,672 S	9/2006	Nagai
D541,761 S	5/2007	Saito et al.
7,224,000 B2	5/2007	Aanegola et al.
D570,506 S	6/2008	Uemoto
D570,797 S	6/2008	Song

1 Claim, 4 Drawing Sheets

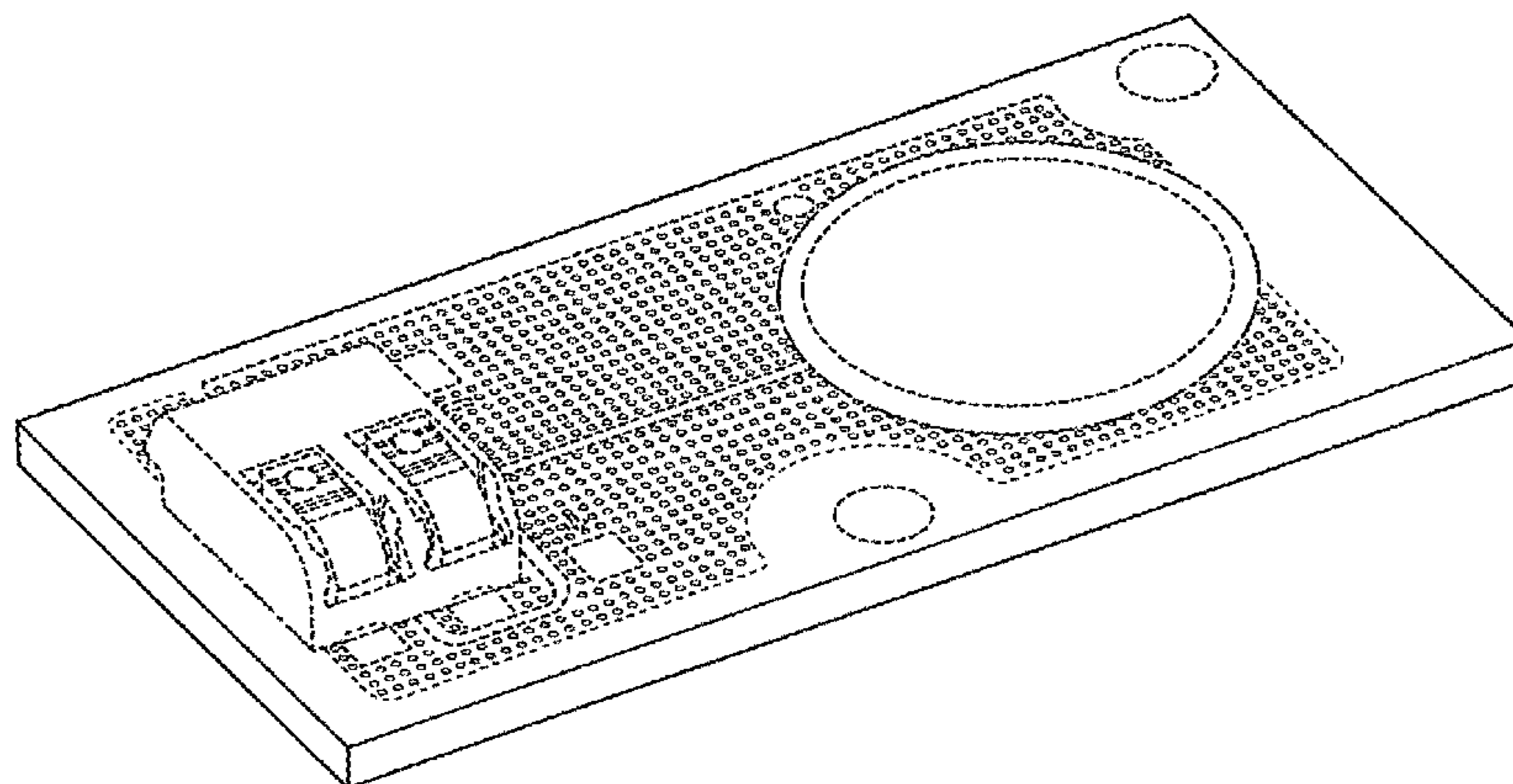

(56)

References Cited

U.S. PATENT DOCUMENTS

7,479,660 B2 1/2009 Kobilke
 7,482,636 B2 1/2009 Murayama et al.
 D586,303 S 2/2009 Fuwa et al.
 D589,470 S 3/2009 Chen
 D591,248 S 4/2009 Imai et al.
 D592,615 S 5/2009 Imai et al.
 D593,043 S 5/2009 Song
 D602,451 S 10/2009 Gielen
 D603,813 S 11/2009 Nishimura et al.
 D607,420 S 1/2010 Imai et al.
 7,649,209 B2 1/2010 Hussell et al.
 D615,051 S 5/2010 Chen et al.
 D615,052 S 5/2010 Imai et al.
 D618,635 S 6/2010 Imai et al.
 7,780,313 B2 8/2010 Lam et al.
 7,825,578 B2 11/2010 Takashima et al.
 D630,171 S 1/2011 Hsieh
 7,872,418 B2 1/2011 Hata et al.
 D636,899 S 4/2011 Shibahara
 D637,564 S 5/2011 Tseng et al.
 D640,997 S 7/2011 Imai et al.
 7,994,518 B2 8/2011 Wang et al.
 D645,417 S 9/2011 Imai et al.
 8,044,418 B2 10/2011 Loh et al.
 8,058,088 B2 11/2011 Cannon
 D650,760 S 12/2011 Hussell et al.
 8,119,534 B2 2/2012 Tanaka et al.
 D658,601 S 5/2012 Egawa et al.
 D658,602 S 5/2012 Egawa et al.
 D658,603 S 5/2012 Egawa et al.
 D667,803 S 9/2012 Hussell et al.
 D669,041 S 10/2012 Imai et al.
 D676,000 S 2/2013 Hussell et al.
 D676,395 S 2/2013 Hussell et al.
 D683,708 S 6/2013 Sasano et al.
 8,455,908 B2 6/2013 Welch et al.
 D689,451 S 9/2013 Shimonishi et al.
 8,564,000 B2 10/2013 Hussell
 8,575,639 B2 11/2013 Hussell
 2004/0196663 A1 10/2004 Ishida et al.
 2005/0264172 A1 12/2005 Wojnarowski et al.
 2006/0139595 A1 6/2006 Koenen et al.
 2006/0147746 A1 7/2006 Wakako et al.
 2006/0186418 A1 8/2006 Edmond
 2007/0018295 A1 1/2007 Kim et al.
 2007/0029569 A1 2/2007 Andrews
 2007/0158668 A1 7/2007 Tarsa
 2007/0194336 A1 8/2007 Shin et al.
 2007/0241345 A1 10/2007 Huang
 2007/0246730 A1 10/2007 Oishi et al.
 2008/0054279 A1 3/2008 Hussell et al.
 2008/0054284 A1 3/2008 Hussell et al.
 2008/0054286 A1 3/2008 Loh et al.
 2008/0089072 A1 4/2008 Kim et al.
 2008/0106723 A1 5/2008 Hoogendam et al.
 2008/0173884 A1 7/2008 Chitnis
 2008/0179611 A1 7/2008 Chitnis
 2008/0191222 A1 8/2008 Lee
 2008/0224166 A1 9/2008 Glovatsky et al.
 2008/0239318 A1 10/2008 Den Boef et al.
 2008/0258130 A1 10/2008 Bergmann
 2009/0122514 A1 5/2009 Yoon et al.
 2009/0261374 A1 10/2009 Hayashi
 2009/0289169 A1 11/2009 Yang et al.
 2009/0315061 A1 12/2009 Andrews
 2010/0078664 A1 4/2010 Helbing
 2010/0096642 A1 4/2010 Chang et al.
 2010/0139836 A1 6/2010 Horikoshi
 2010/0141182 A1 6/2010 Shi
 2010/0155763 A1 6/2010 Donofrio
 2010/0193822 A1 8/2010 Inobe et al.
 2010/0253248 A1 10/2010 Shi
 2010/0270567 A1 10/2010 Emerson et al.
 2010/0320483 A1 12/2010 Kadotani et al.
 2011/0068674 A1 3/2011 Takenaka et al.

2011/0121323 A1 5/2011 Wu et al.
 2011/0127912 A1 6/2011 Lee et al.
 2011/0128730 A1 6/2011 Chiu
 2011/0291151 A1 12/2011 Matsuda et al.
 2012/0126255 A1 5/2012 Hussell et al.
 2012/0126257 A1 5/2012 Reiherzer et al.
 2012/0193651 A1 8/2012 Edmond
 2012/0205689 A1 8/2012 Welch
 2012/0241807 A1 9/2012 Hoetzel et al.
 2012/0299022 A1 11/2012 Hussell
 2013/0058099 A1 3/2013 Shum et al.
 2013/0256711 A1 10/2013 Joo et al.

FOREIGN PATENT DOCUMENTS

EP 2 643 862 10/2013
 JP 10-311937 11/1998
 JP 2001-294083 10/2001
 JP 2006-294898 10/2006
 JP 2007-266357 10/2007
 JP 2009-044055 2/2009
 JP 2009-289918 12/2009
 JP 2010-009972 1/2010
 JP 1476166 7/2013
 JP 1476175 7/2013
 KR 10-0793338 1/2008
 KR 10-2008-0092239 10/2008
 KR 10-2009-0011121 2/2009
 TW D125589 10/2008
 TW D141645 7/2011
 TW D144159 12/2011
 TW D145644 3/2012
 TW D156539 10/2013
 WO WO 2012/071136 5/2012
 WO WO 2012/071139 5/2012
 WO WO 2013/070696 5/2013
 WO WO 2013/096431 6/2013
 WO WO 2013/122831 8/2013

OTHER PUBLICATIONS

Taiwanese Search Report for Application No. 102300058 dated Apr. 29, 2013.
 Taiwanese Search Report for Application No. 102301395 dated Jul. 9, 2013.
 Taiwanese Office Action for Application No. 102301395 dated Jul. 15, 2013.
 Taiwanese Office Action for Application No. 102300058 dated Aug. 27, 2013.
 Taiwanese Office Action for Application No. 102301581 dated Sep. 6, 2013.
 Taiwanese Office Action for Application No. 102301582 dated Sep. 6, 2013.
 Taiwanese Office Action for Application No. 102301583 dated Sep. 6, 2013.
 Taiwanese Office Action for Application No. 102301584 dated Sep. 6, 2013.
 Taiwanese Office Action for Application No. 102301585 dated Sep. 6, 2013.
 Restriction Requirement for U.S. Appl. No. 13/798,882 dated Sep. 20, 2013.
 Restriction Requirement for U.S. Appl. No. 29/417,220 dated Sep. 27, 2013.
 Restriction Requirement for U.S. Appl. No. 29/451,177 dated Sep. 27, 2013.
 Restriction Requirement for U.S. Appl. No. 29/425,831 dated Sep. 30, 2013.
 Taiwanese Office Action for Application No. 102300059 dated Oct. 1, 2013.
 Chinese Notice to Grant for Application No. 201330361367.2 dated Oct. 8, 2013.
 Notice of Allowance for U.S. Appl. No. 13/671,089 dated Oct. 22, 2013.
 Restriction Requirement for U.S. Appl. No. 29/412,168 dated Oct. 25, 2013.

(56)

References Cited

OTHER PUBLICATIONS

- Non-Final Office Action for U.S. Appl. No. 13/793,882 dated Nov. 15, 2013.
- U.S. Appl. No. 13/336,540, filed Dec. 23, 2011.
- Office Action/Restriction Requirement for U.S. Appl. No. 13/028,972 dated Jul. 25, 2012.
- Notification of Grant for Chinese Patent Application No. 2012/30099981.1 dated Aug. 17, 2012.
- Notice of Allowance for U.S. Appl. No. 29/407,084 dated Aug. 21, 2012.
- Notice of Allowance for U.S. Appl. No. 29/380,387 dated Sep. 18, 2012.
- Notice of Allowance for U.S. Appl. No. 29/408,955 dated Oct. 4, 2012.
- Non-Final Office Action for U.S. Appl. No. 13/028,972 dated Oct. 10, 2012.
- Non-Final Office for U.S. Appl. No. 13/104,558 dated Jan. 3, 2013.
- Bridgelux Product Data Sheet—1 page.
- Citizen Co. Product Data Sheet—4 pages http://ce.citizen.co.jp/lighting_led/en/products/index.html.
- U.S. Appl. No. 29/379,636 for “Light Emitting Device Package”.
- Design U.S. Appl. No. 29/380,387 for “Light Emitting Device Package” filed Dec. 3, 2010.
- U.S. Appl. No. 13/028,972 for “Light Emitting Devices and Methods” filed Feb. 16, 2011.
- U.S. Appl. No. 13/104,558 for “Light Emitting Devices and Methods” filed May 10, 2011.
- Notice of Allowance for U.S. Appl. No. 29/379,636 dated Aug. 4, 2011.
- Design U.S. Appl. No. 29/404,913 for “Light Emitting Device Component” filed Oct. 26, 2011.
- U.S. Appl. No. 13/224,850 for “Light Emitting Device Component” filed Sep. 2, 2011.
- Design U.S. Appl. No. 29/379,636 for “Light Emitting Device Package” filed Nov. 22, 2011.
- Design U.S. Appl. No. 29/408,955 for “Light Emitting Device Package” filed Dec. 19, 2011.
- Notification of Granting Patent Right for Design for Application Serial No. CN 2011/30166527.9 dated Apr. 6, 2012.
- Non-Final Office Action for U.S. Appl. No. 29/380,387 dated Apr. 25, 2012.
- Notification of Granting Patent Right for Design for Application Serial No. CN 2011/30139847.5 dated Apr. 26, 2012.
- Notice of Allowance for U.S. Appl. No. 29/408,955 dated May 7, 2012.
- Notice of Allowance for U.S. Appl. No. 29/407,084 dated May 18, 2012.
- International Search Report and Written Opinion for Application Serial No. PCT/US2011/058603 dated May 23, 2012.
- International Search Report and Written Opinion for Application Serial No. PCT/US2011/058601 dated May 24, 2012.
- Taiwanese Search Report for Application No. 101302309 dated Jan. 14, 2013.
- Taiwanese Office Action for Application No. 101302309 dated Jan. 23, 2013.
- Chinese Decision to Grant for Application No. 201230472866.4 dated Jan. 24, 2013.
- Notice of Allowance for U.S. Appl. No. 13/336,540 dated Jan. 31, 2013.
- Restriction Requirement for U.S. Appl. No. 13/671,089 dated Feb. 7, 2013.
- Restriction Requirement for U.S. Appl. No. 29/404,913 dated Feb. 15, 2013.
- Japanese Office Action for Application No. 2012-023963 dated Feb. 26, 2013.
- Japanese Office Action for Application No. 2012-026117 dated Feb. 26, 2013.
- Chinese Office Action for Application No. CN 2012/30130915.6 dated Feb. 27, 2013.
- Notice of Allowance for U.S. Appl. No. 13/028,972 dated Feb. 28, 2013.
- International Search Report and Written Opinion for Application No. PCT/US2012/051344 dated Feb. 28, 2013.
- International Search Report and Written Opinion for Application No. PCT/US2012/063861 dated Mar. 18, 2013.
- Non-Final Office Action for U.S. Appl. No. 13/671,089 dated Mar. 29, 2013.
- International Search Report and Written Opinion for Application No. PCT/US2012/070589 dated Apr. 22, 2013.
- International Search Report and Written Opinion for Application No. PCT/US2013/025307 dated May 15, 2013.
- Notice of Allowance for U.S. Appl. No. 13/028,972 dated May 23, 2013.
- Japanese Office Action for Application No. 2012-031549 dated Jun. 4, 2013.
- Japanese Decision of Registration for Application No. 2012-023963 dated Jun. 4, 2013.
- Japanese Decision of Registration for Application No. 2012-026117 dated Jun. 4, 2013.
- Taiwanese Notice of Allowance for Application No. 101302309 dated Jun. 5, 2013.
- Notice of Allowance for U.S. Appl. No. 13/435,912 dated Jun. 19, 2013.
- Notice of Allowance for U.S. Appl. No. 29/404,913 dated Jun. 25, 2013.
- Chinese Notice of Grant for Application No. 201230652790.3 dated Jun. 26, 2013.
- Notice of Allowance for U.S. Appl. No. 13/104,558 dated Jul. 1, 2013.
- Chinese Notice of Grant for Application No. 201230130915.6 dated Jul. 3, 2013.
- Chinese Decision to Grant for Application No. 201230652789 dated Jul. 17, 2013.
- Taiwanese Search Report for Application No. 102301394 dated Jul. 9, 2013.
- Taiwanese Office Action for Application No. 102301394 dated Jul. 15, 2013.
- Chinese Notice of Grant for Application No. 201230652840.3 dated Jul. 26, 2013.
- Ex Parte Quayle Action for U.S. Appl. No. 13/671,089 dated Aug. 13, 2013.
- Korean Office Action for Application No. 30-2012-0020196 dated Aug. 13, 2013.
- Korean Office Action for Application No. 30-2012-0020197 dated Aug. 13, 2013.
- Korean Office Action for Application No. 30/2012-0020198 dated Aug. 13, 2013.
- Notice of Allowance for Application No. 13/104,558 dated Aug. 28, 2013.
- Non-Final Office Action for U.S. Appl. No. 13/224,850 dated Sep. 5, 2013.

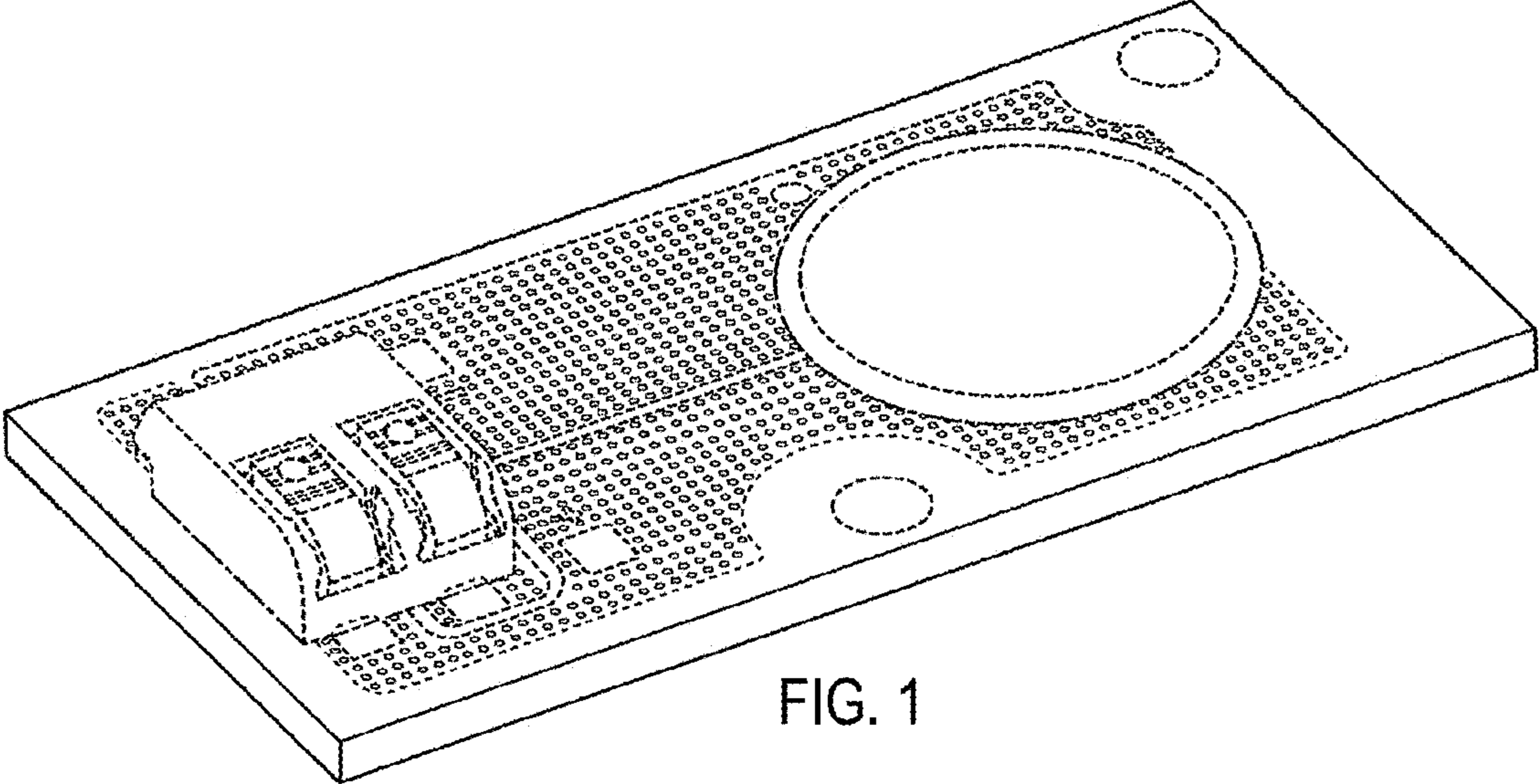

FIG. 1

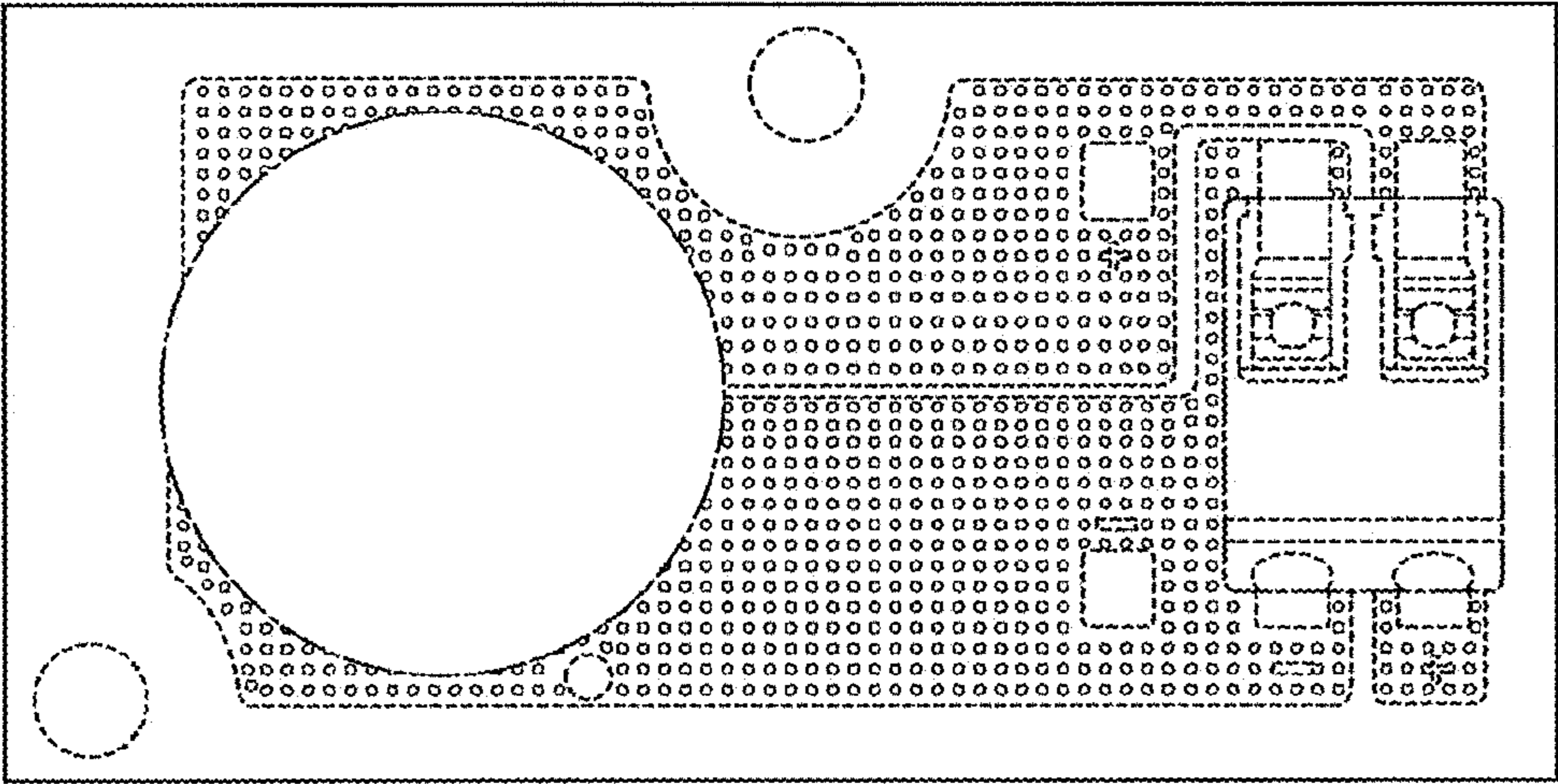

FIG. 2

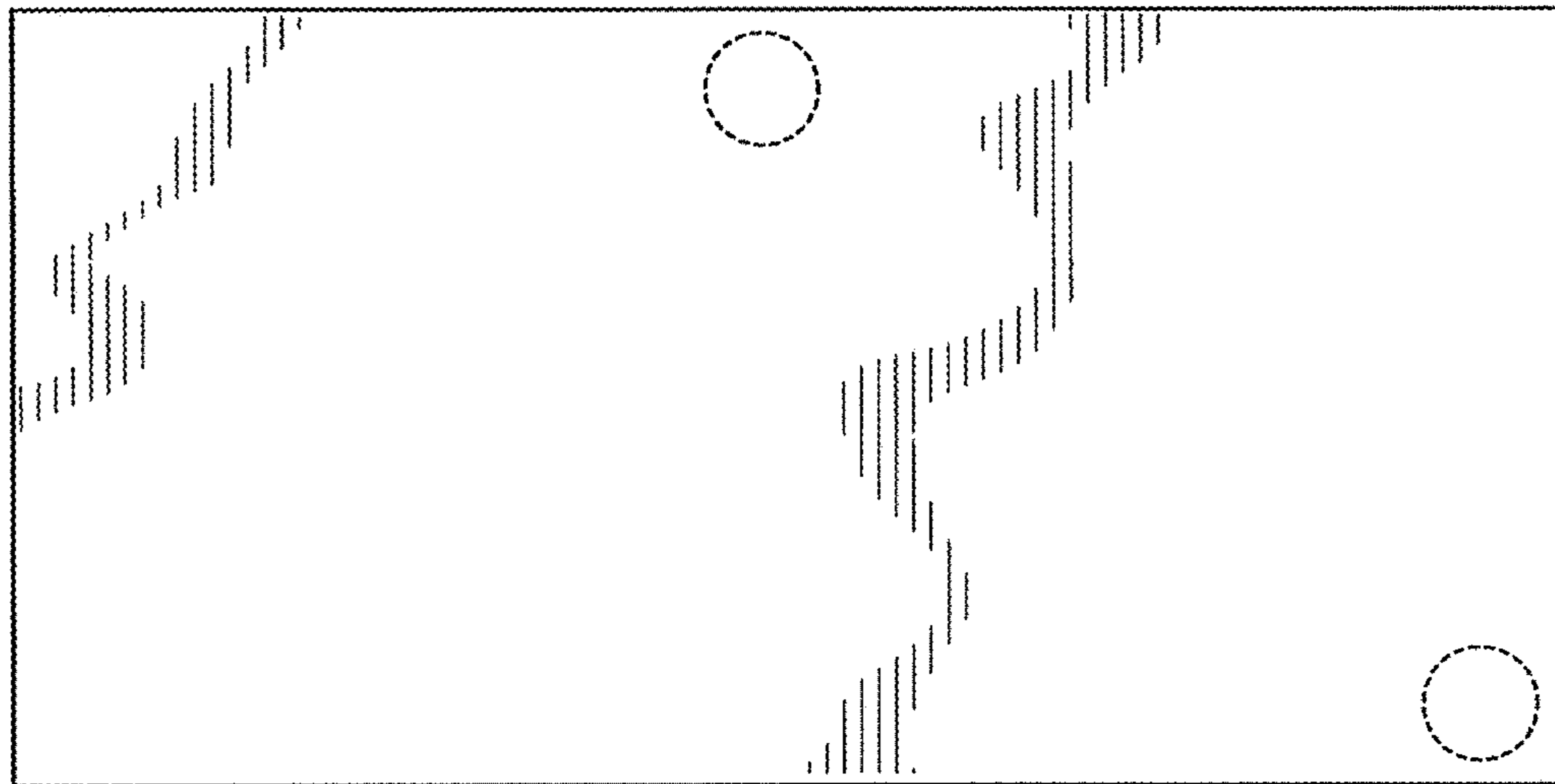

FIG. 3

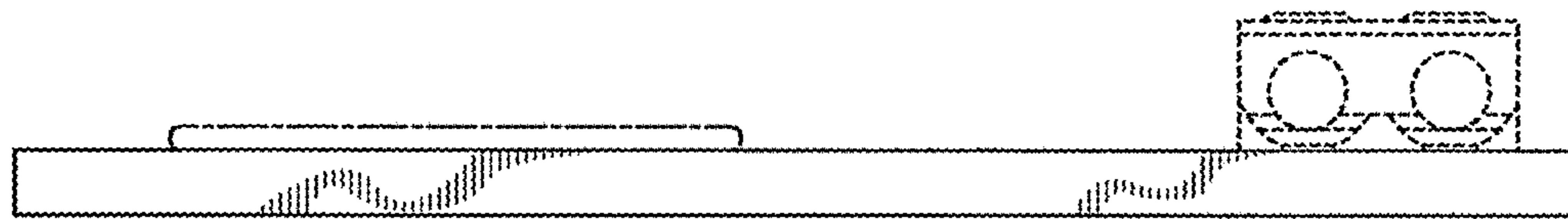

FIG. 4

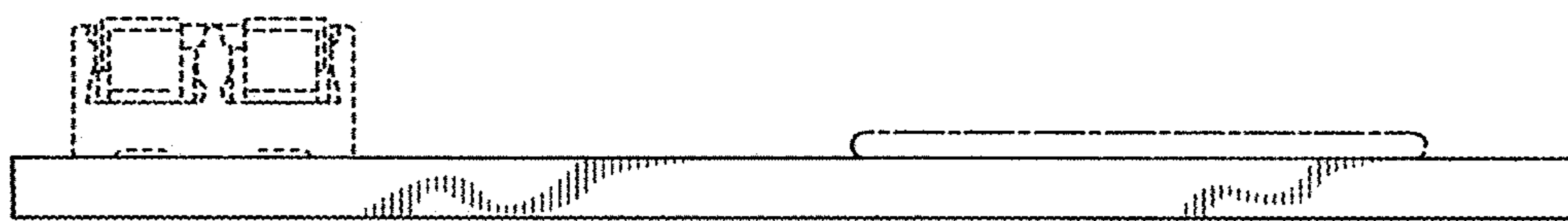

FIG. 5

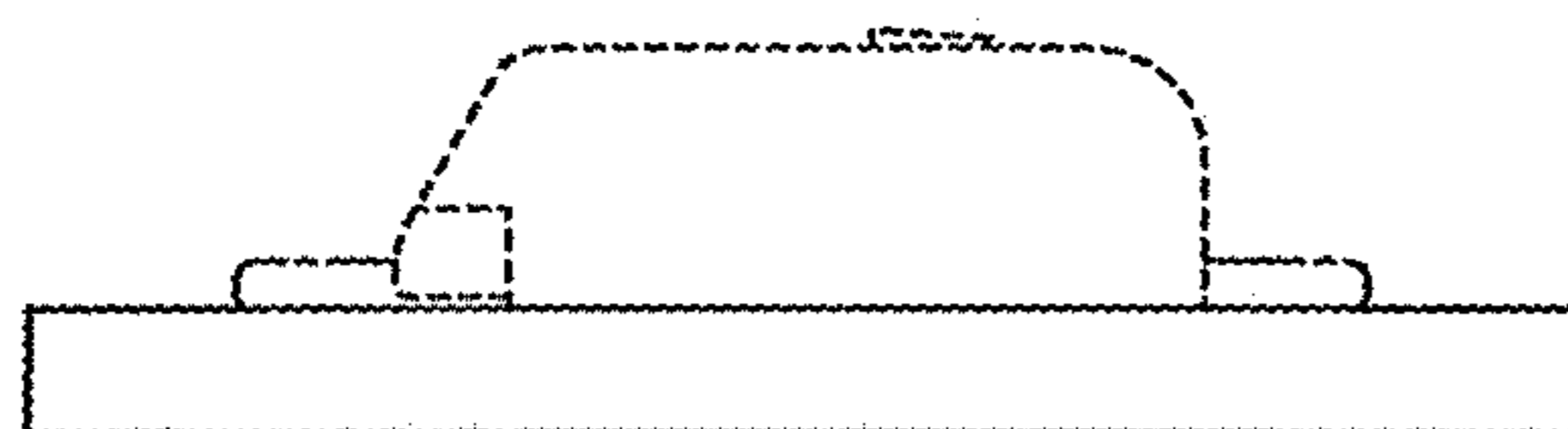

FIG. 6

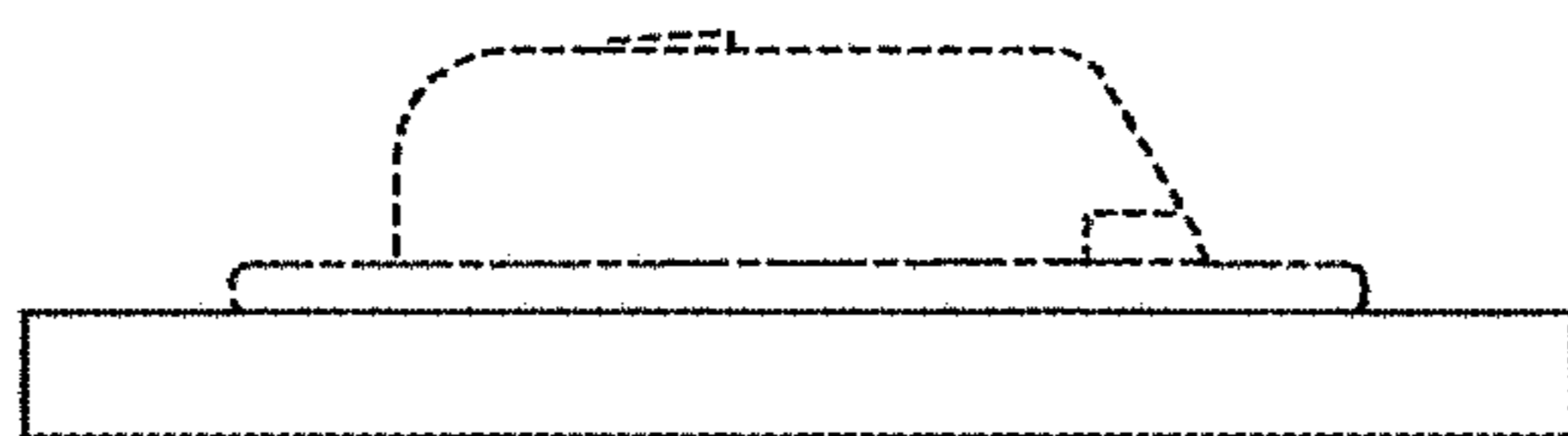

FIG. 7