



US00D705018S

(12) **United States Design Patent**
Liotta

(10) **Patent No.:** **US D705,018 S**
(45) **Date of Patent:** **** May 20, 2014**

- (54) **UTENSIL HOLDER**
- (71) Applicant: **Steven Liotta**, Salem, NH (US)
- (72) Inventor: **Steven Liotta**, Salem, NH (US)
- (**) Term: **14 Years**
- (21) Appl. No.: **29/461,313**
- (22) Filed: **Jul. 22, 2013**
- (51) **LOC (10) Cl.** **07-06**
- (52) **U.S. Cl.**
USPC **D7/637; D7/601**
- (58) **Field of Classification Search**
USPC D7/601, 637-641; 206/553; 248/37.3,
248/174, 175, 176.1; 211/70.1, 70.6, 70.7,
211/60.1, 13.1
See application file for complete search history.

- 4,995,515 A * 2/1991 Smith 211/65
- 5,411,141 A * 5/1995 Bounds 206/553
- 8,668,171 B2 * 3/2014 Tarantino et al. 248/37.3

* cited by examiner

Primary Examiner — Terry Wallace

(74) *Attorney, Agent, or Firm* — Lando & Anastasi, LLP

(57) **CLAIM**

The ornamental design for a utensil holder, as shown and described.

DESCRIPTION

FIG. 1 is a perspective view of a utensil holder design of an embodiment of the present disclosure;
 FIG. 2 is a right side view thereof;
 FIG. 3 is a left side view thereof;
 FIG. 4 is a top plan view thereof;
 FIG. 5 is a bottom plan view thereof;
 FIG. 6 is a front elevational view thereof;
 FIG. 7 is a rear elevational view thereof;
 FIG. 8 is a perspective view of a utensil holder design of another embodiment of the present disclosure;
 FIG. 9 is a right side view thereof;
 FIG. 10 is a left side view thereof;
 FIG. 11 is a top plan view thereof;
 FIG. 12 is a bottom plan view thereof;
 FIG. 13 is a front elevational view thereof; and,
 FIG. 14 is a rear elevational view thereof.
 The broken lines shown represent unclaimed subject matter and form no part of the claimed design.

(56) **References Cited**

U.S. PATENT DOCUMENTS

227,224 A	5/1880	Dodge	
799,612 A	9/1905	Moore	
1,264,914 A	5/1918	Fresh	
1,647,154 A	11/1927	Soybel	
2,354,968 A	8/1944	Pickering	
2,567,817 A	9/1951	Lunde	
2,615,318 A	10/1952	Gray	
2,651,927 A	9/1953	Mullins	
2,789,349 A	4/1957	Lee	
4,834,328 A *	5/1989	Hall	248/37.3
4,858,863 A *	8/1989	Lin	248/174
4,940,199 A	7/1990	Hall	

1 Claim, 8 Drawing Sheets

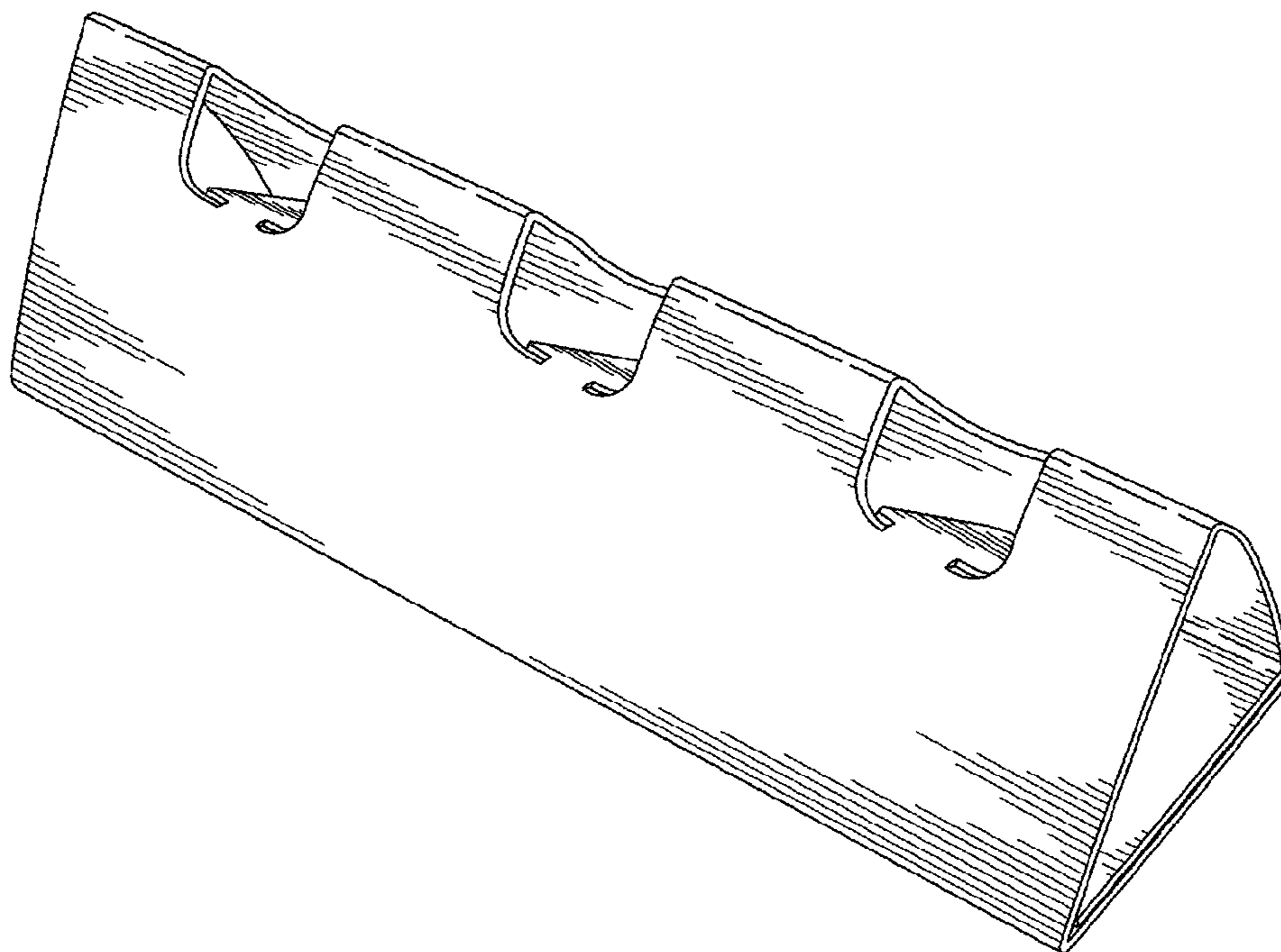

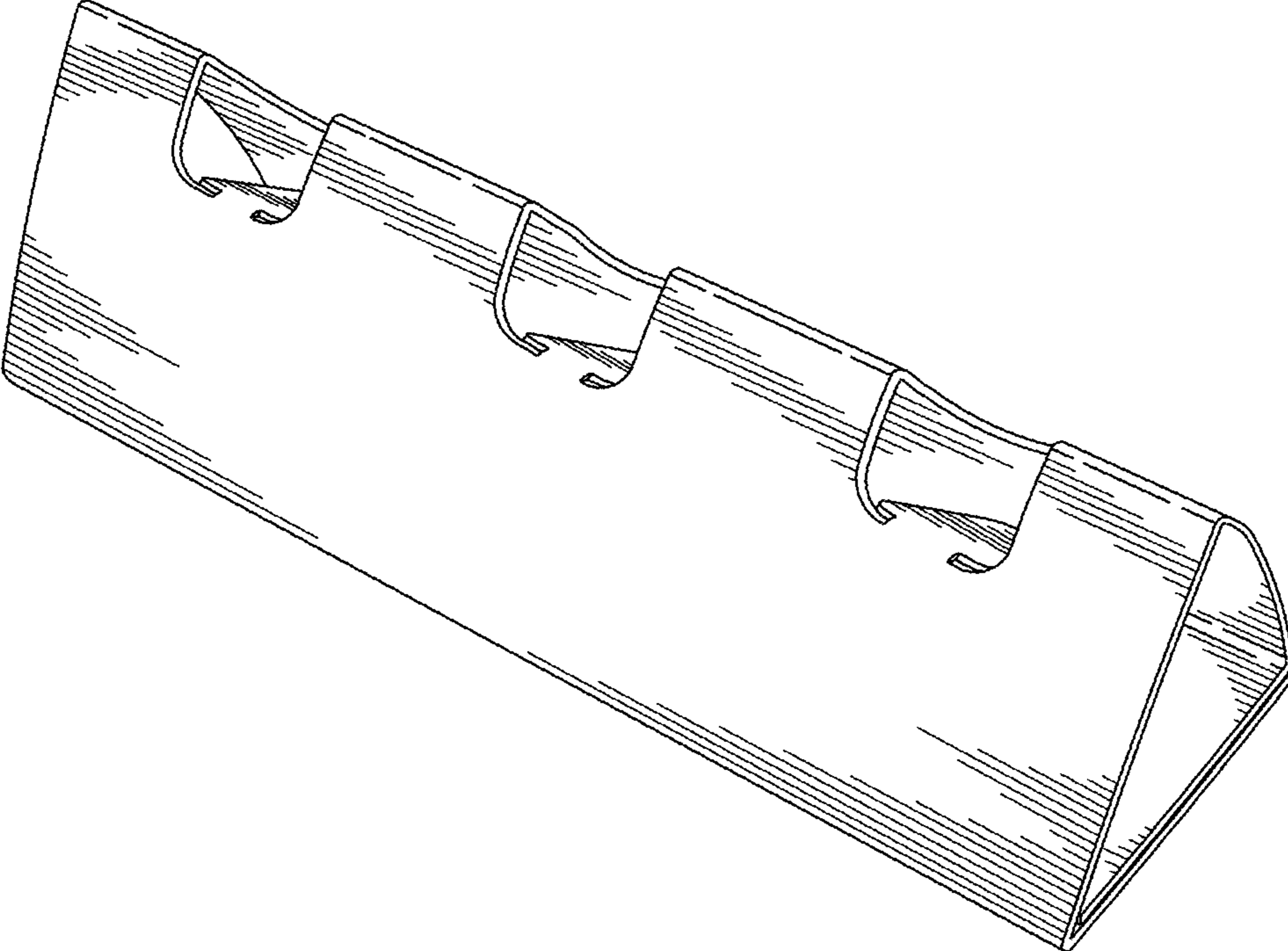

FIG. 1

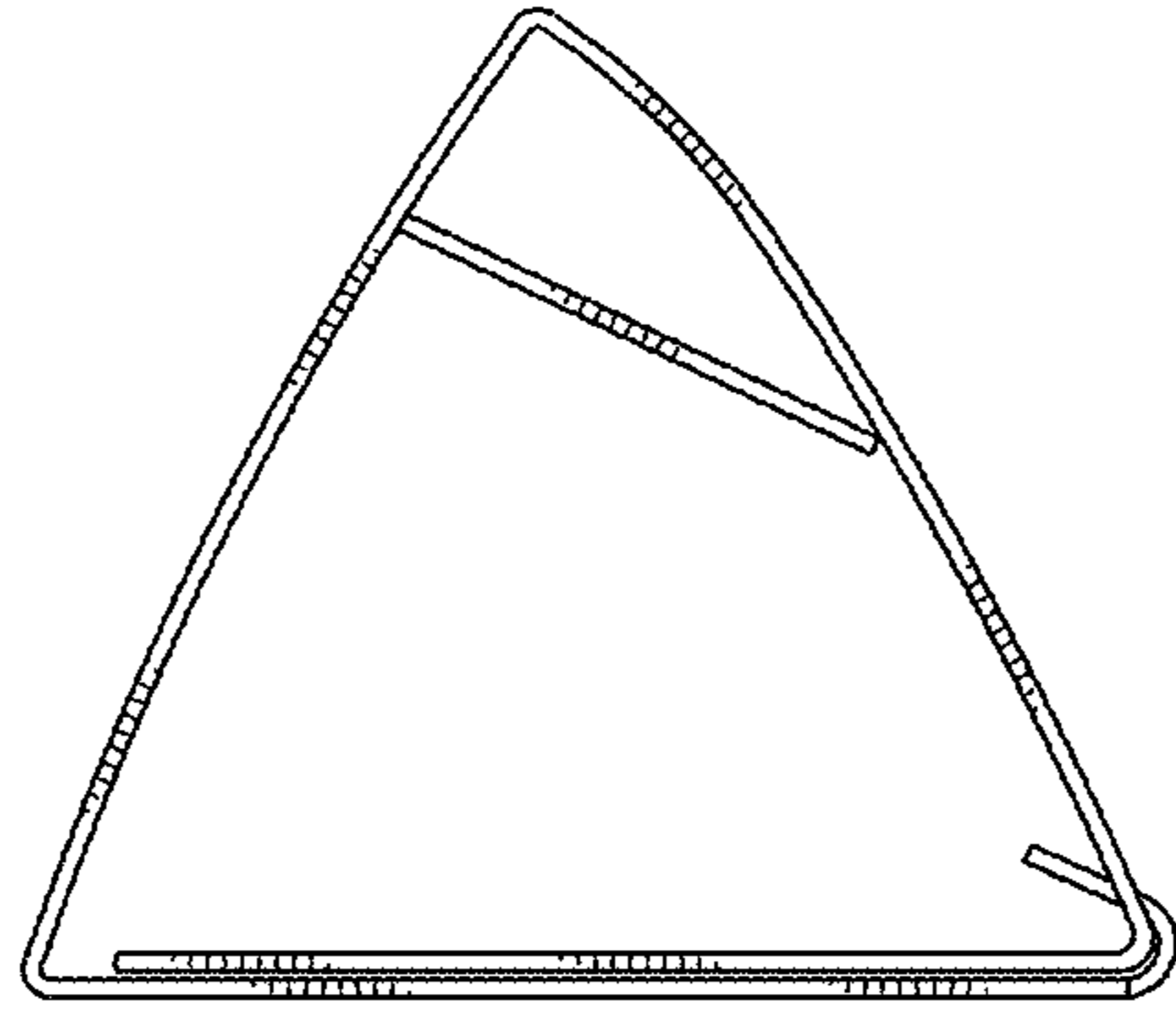

FIG. 2

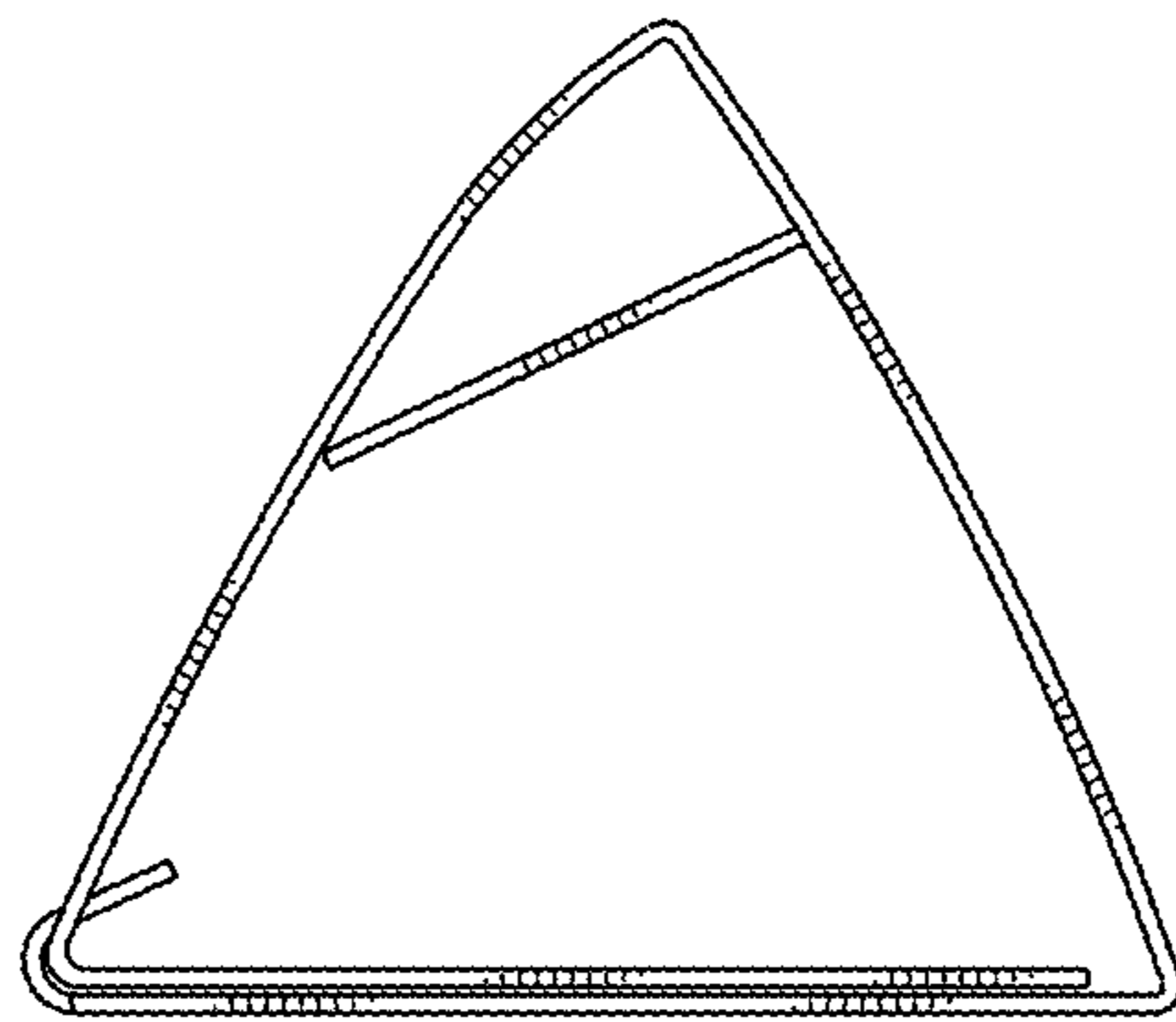

FIG. 3

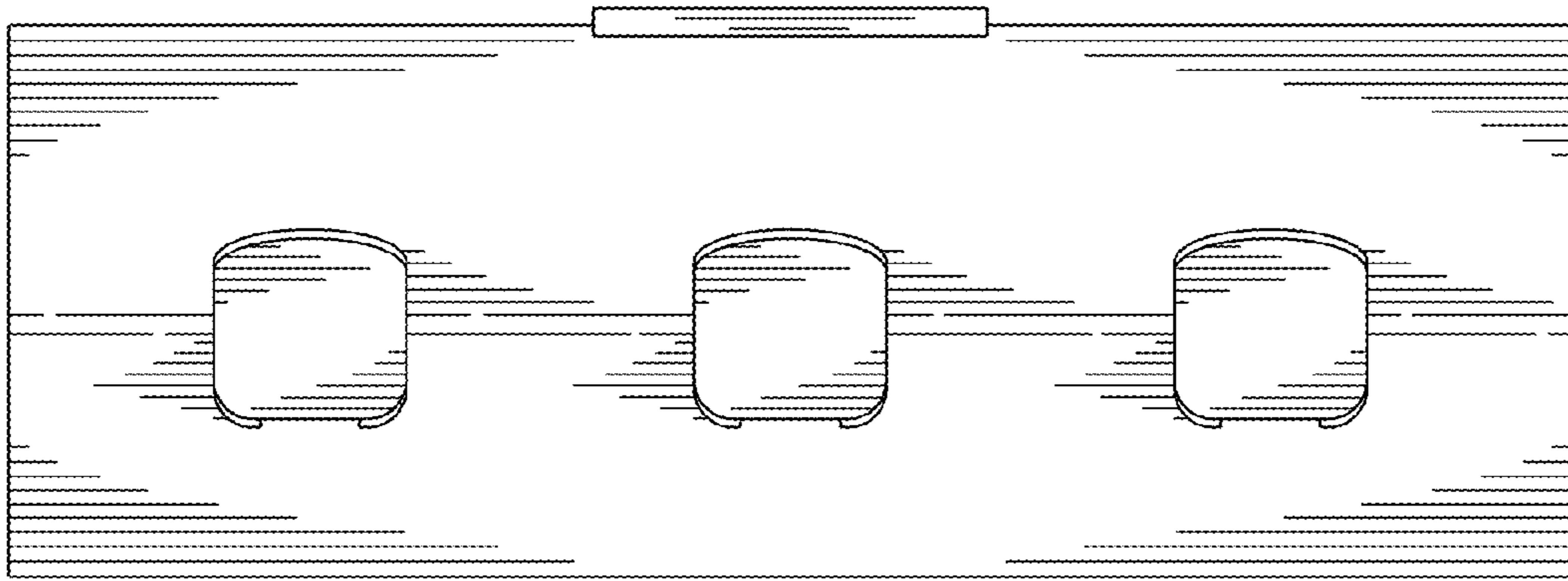

FIG. 4

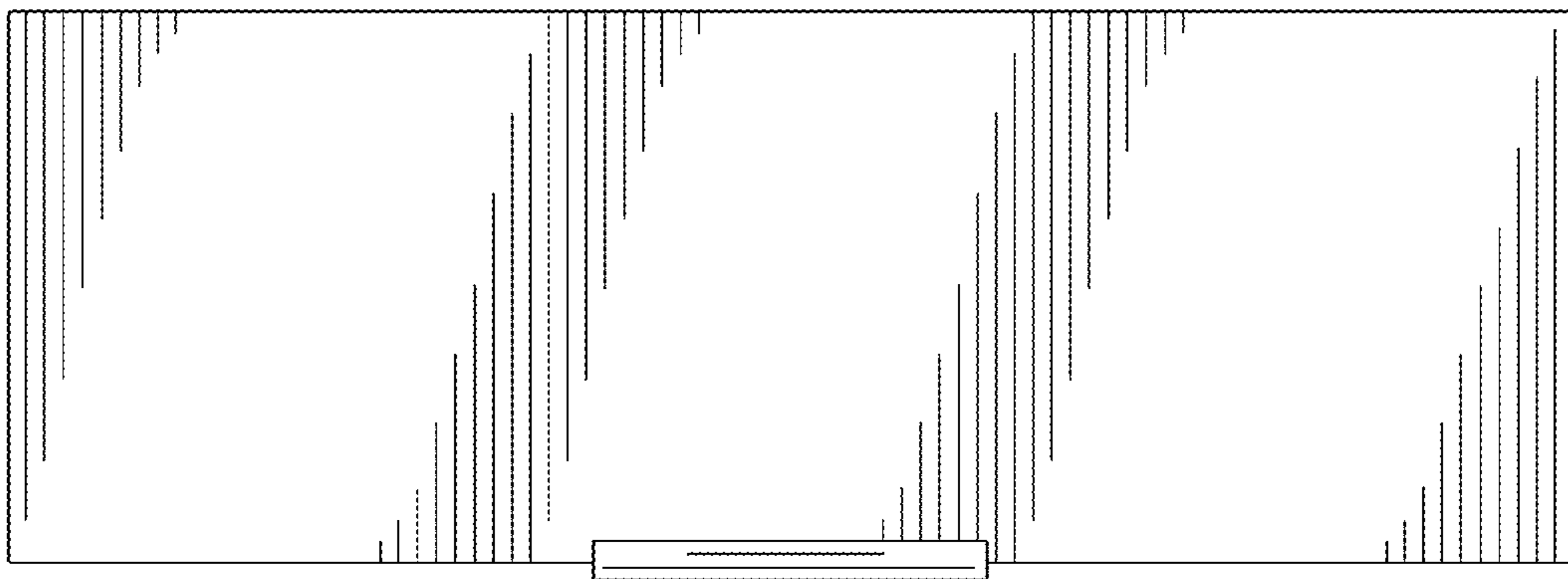

FIG. 5

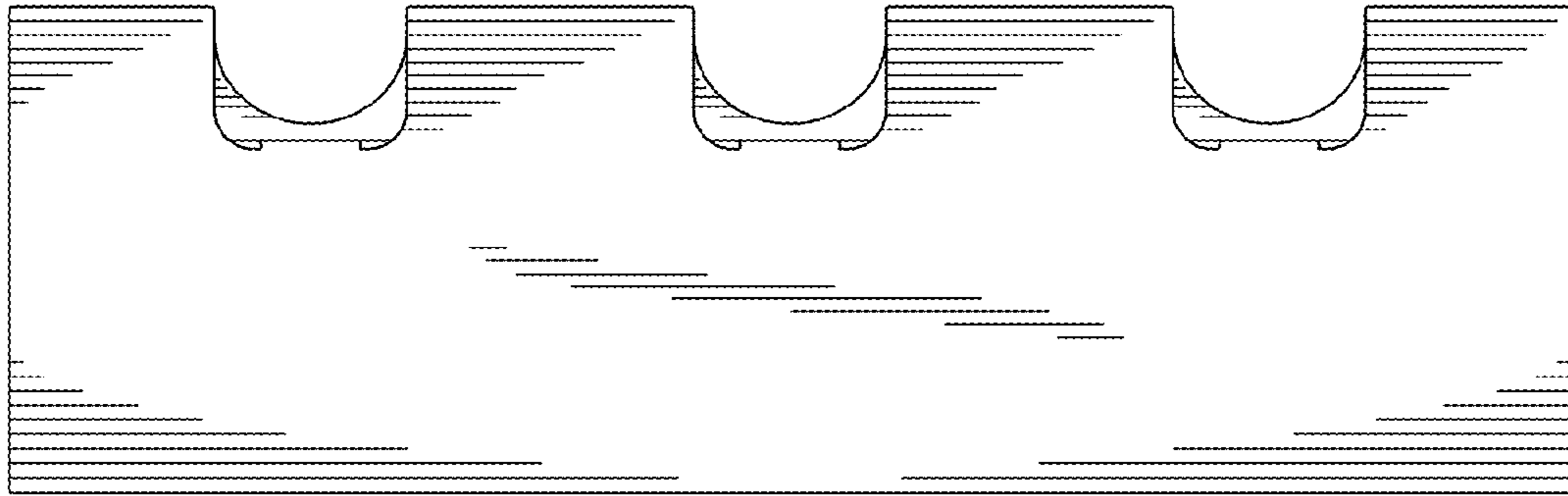

FIG. 6

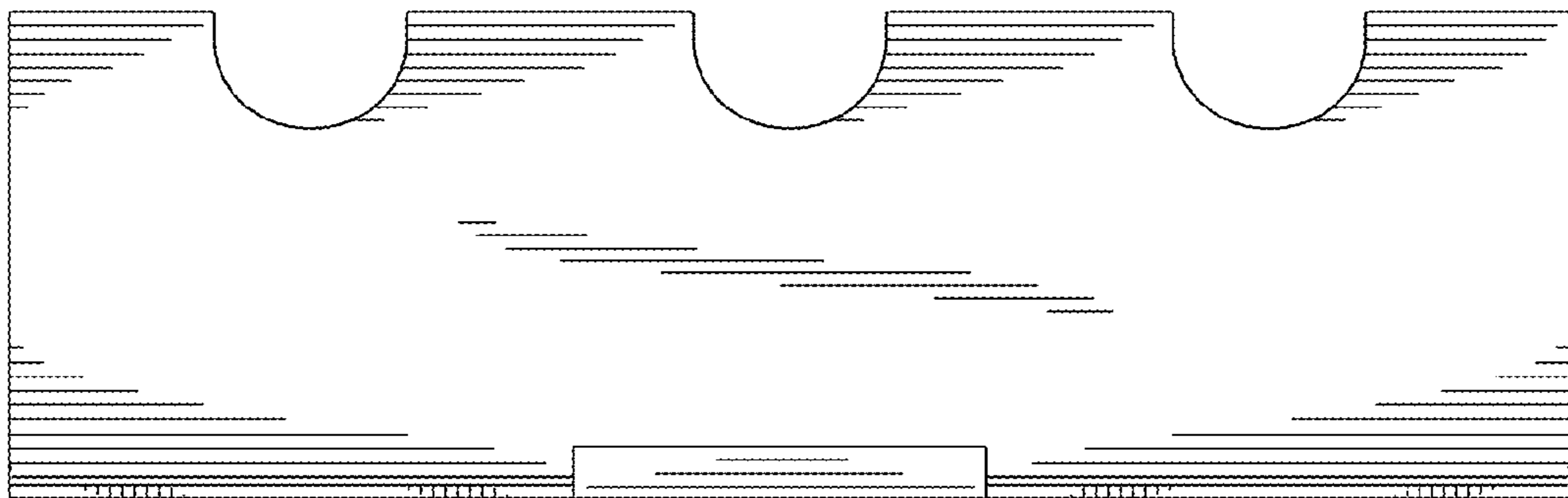

FIG. 7

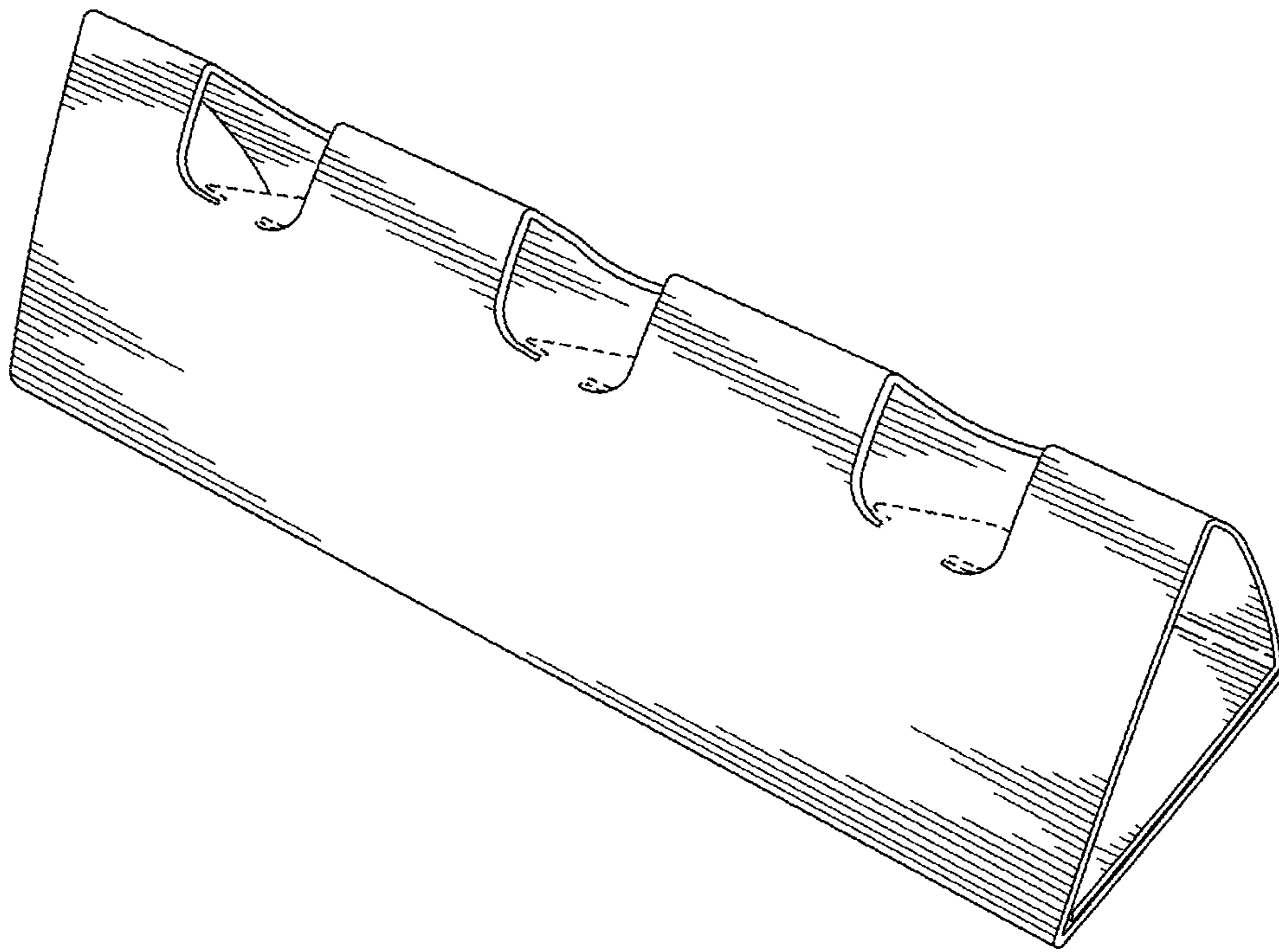

FIG. 8

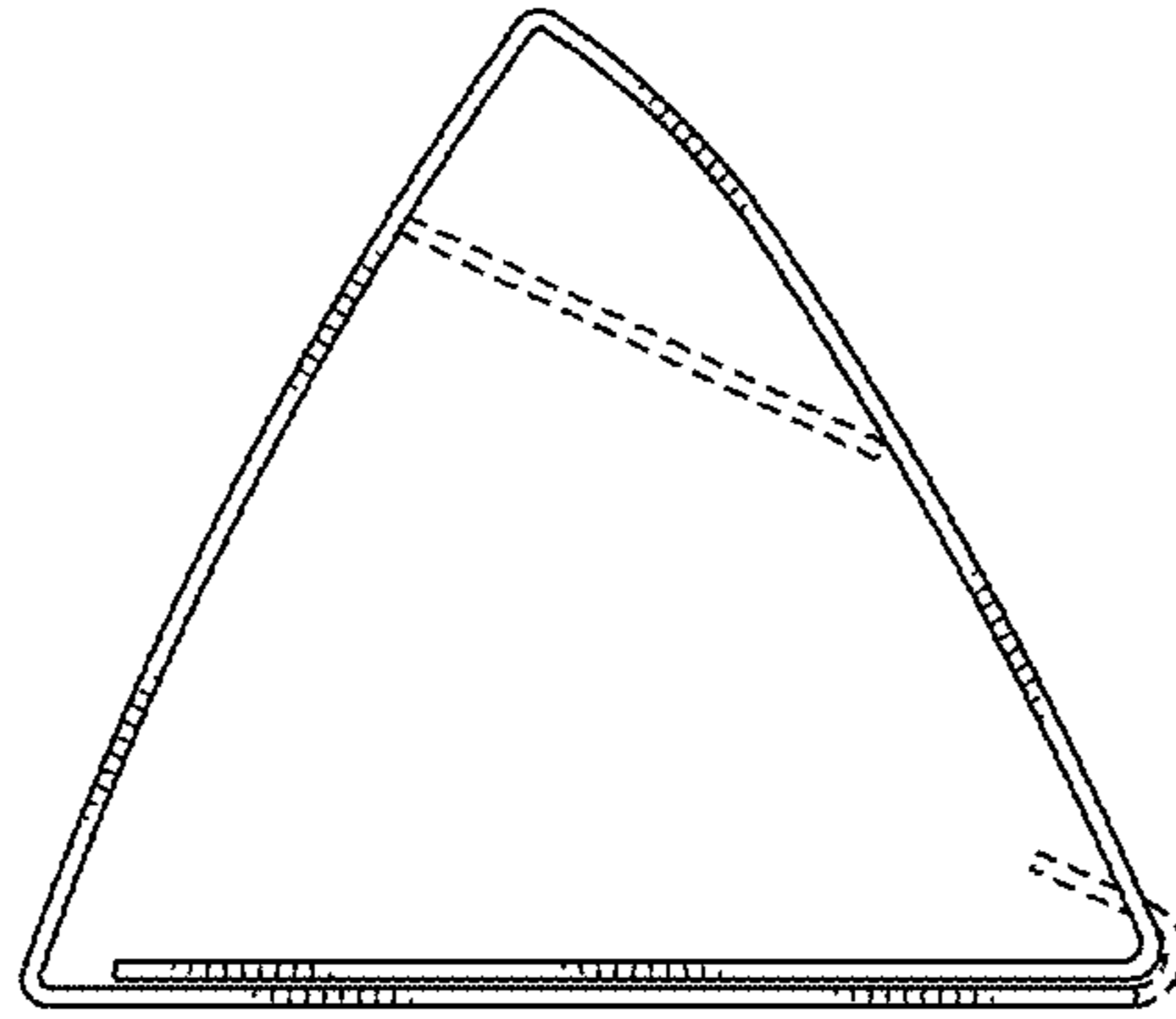

FIG. 9

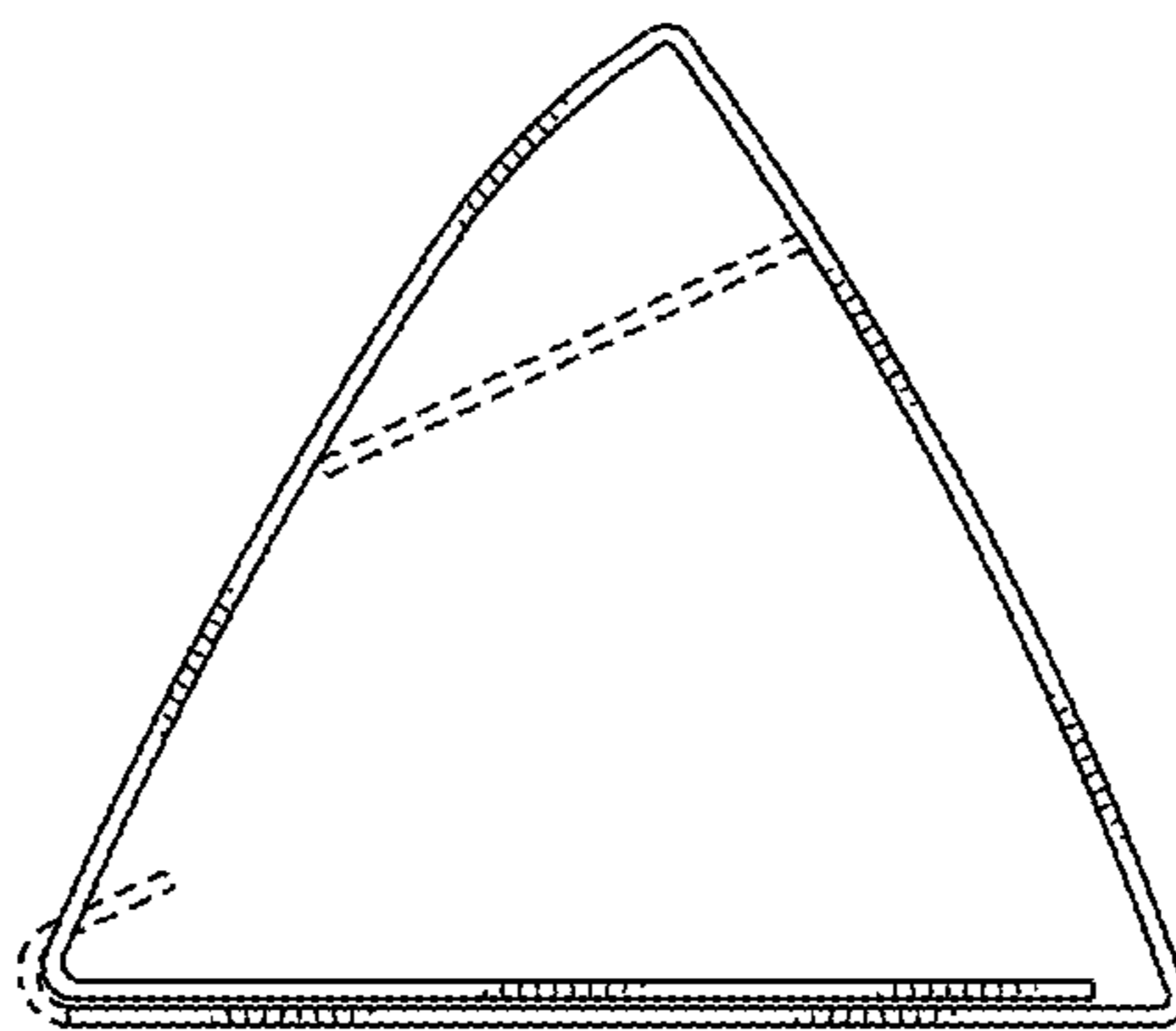

FIG. 10

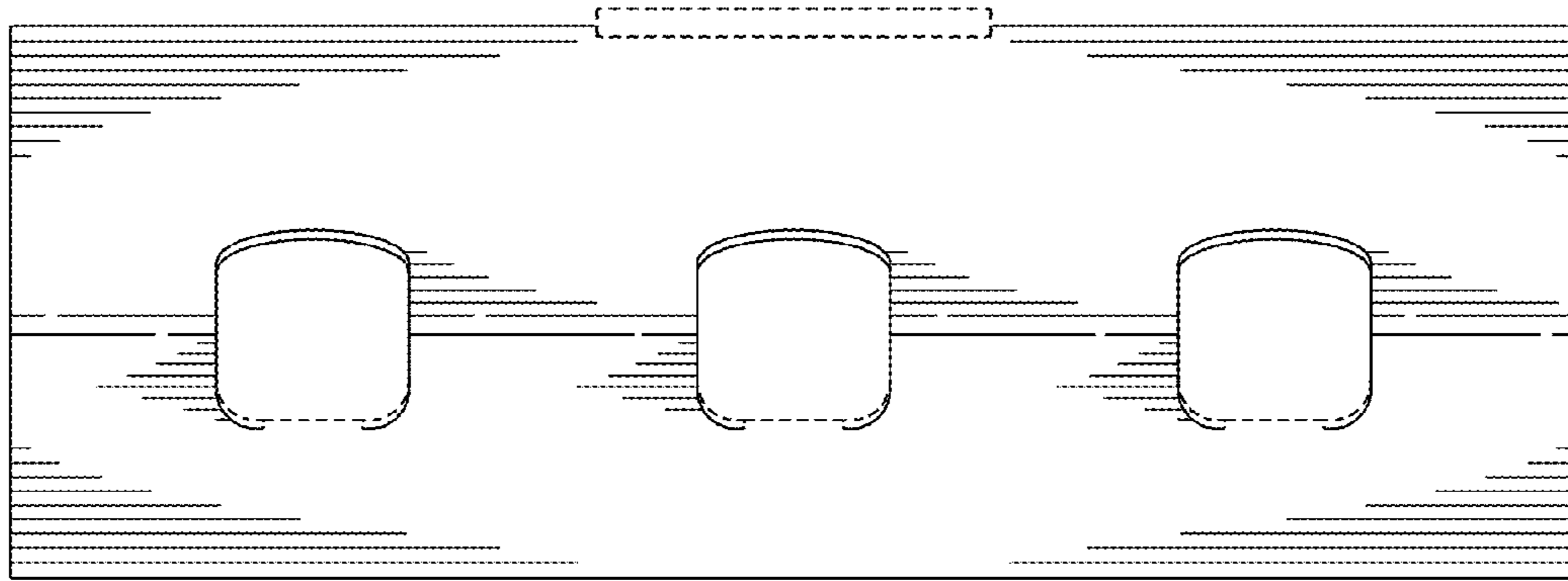

FIG. 11

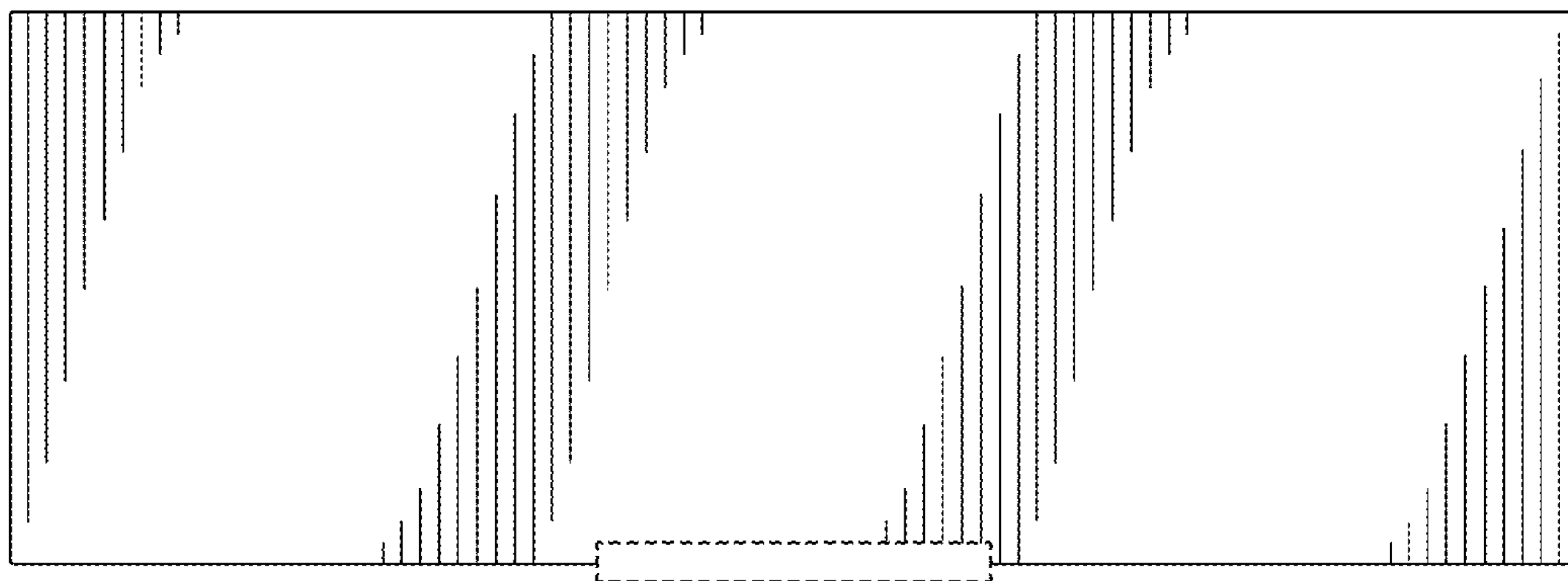

FIG. 12

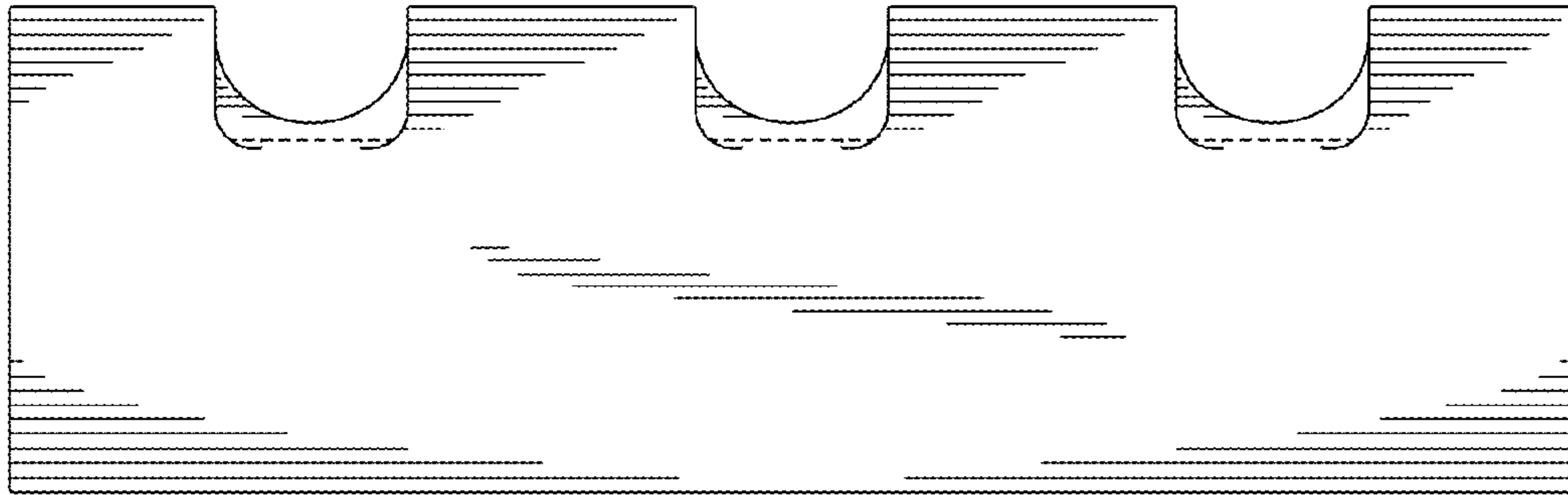

FIG. 13

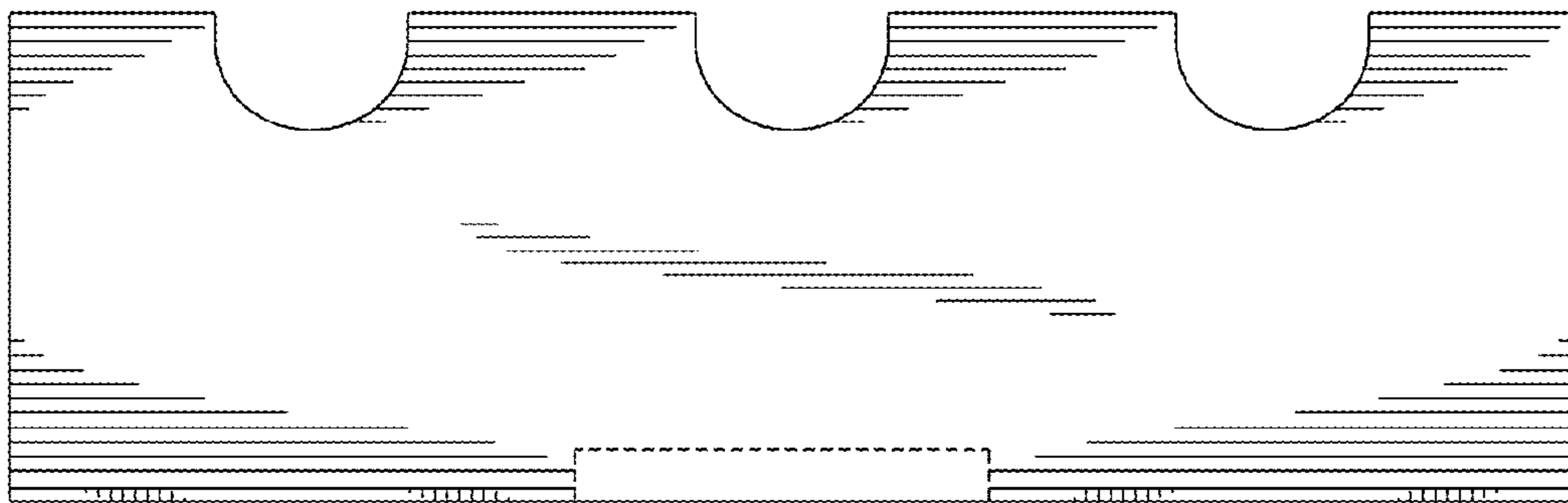

FIG. 14