



US00D705011S

(12) **United States Design Patent**
Chen et al.

(10) **Patent No.:** **US D705,011 S**

(45) **Date of Patent:** **** May 20, 2014**

(54) **INVISIBLE HEART MUG**

(76) Inventors: **Zheng Yu Chen**, Highland Reach, CO
(US); **Qun Lu**, Highland Reach, CO
(US)

(**) Term: **14 Years**

(21) Appl. No.: **29/428,140**

(22) Filed: **Jul. 26, 2012**

(51) **LOC (10) Cl.** **07-01**

(52) **U.S. Cl.**

USPC **D7/515**; D7/536

(58) **Field of Classification Search**

USPC D7/510, 511, 509, 523, 608, 515, 514,
D7/533, 536; 366/130; 220/703, 592.16,
220/592.17, 739; D9/629

See application file for complete search history.

(56) **References Cited**

U.S. PATENT DOCUMENTS

D119,280 S *	3/1940	May	D7/531
D148,580 S *	2/1948	Ross	D7/516
D168,784 S *	2/1953	Del Mas	D7/514
4,523,083 A *	6/1985	Hamilton	219/433
D371,937 S *	7/1996	Peugeot et al.	D7/536
D375,456 S *	11/1996	Borgmann	D9/629
D395,379 S *	6/1998	Goodman	D7/513
D444,033 S *	6/2001	Saffron et al.	D7/516

D455,933 S *	4/2002	Marck	D7/536
D574,719 S *	8/2008	Erekson	D9/629
D625,953 S *	10/2010	Claffey	D7/507
D632,134 S	2/2011	Sijing et al.	D7/514
D639,608 S *	6/2011	Tohm, Sr.	D7/536

* cited by examiner

Primary Examiner — Marianne Pandozzi

(74) *Attorney, Agent, or Firm* — Morgan, Lewis & Bockius LLP

(57) **CLAIM**

The ornamental design for an invisible heart mug, as shown.

DESCRIPTION

FIG. 1 is a rear perspective view of an invisible heart mug showing our new design;

FIG. 2 is a front perspective view thereof;

FIG. 3 is a bottom front perspective view thereof;

FIG. 4 is a bottom rear perspective view thereof;

FIG. 5 is a front view thereof;

FIG. 6 is a rear view thereof;

FIG. 7 is a right side view thereof;

FIG. 8 is a left side view thereof;

FIG. 9 is a top view thereof;

FIG. 10 is a bottom view thereof;

FIG. 11 is a top view thereof having liquid inside;

FIG. 12 is a top view thereof having a small amount of liquid inside; and,

FIG. 13 is a top view thereof having almost no liquid left inside.

1 Claim, 6 Drawing Sheets

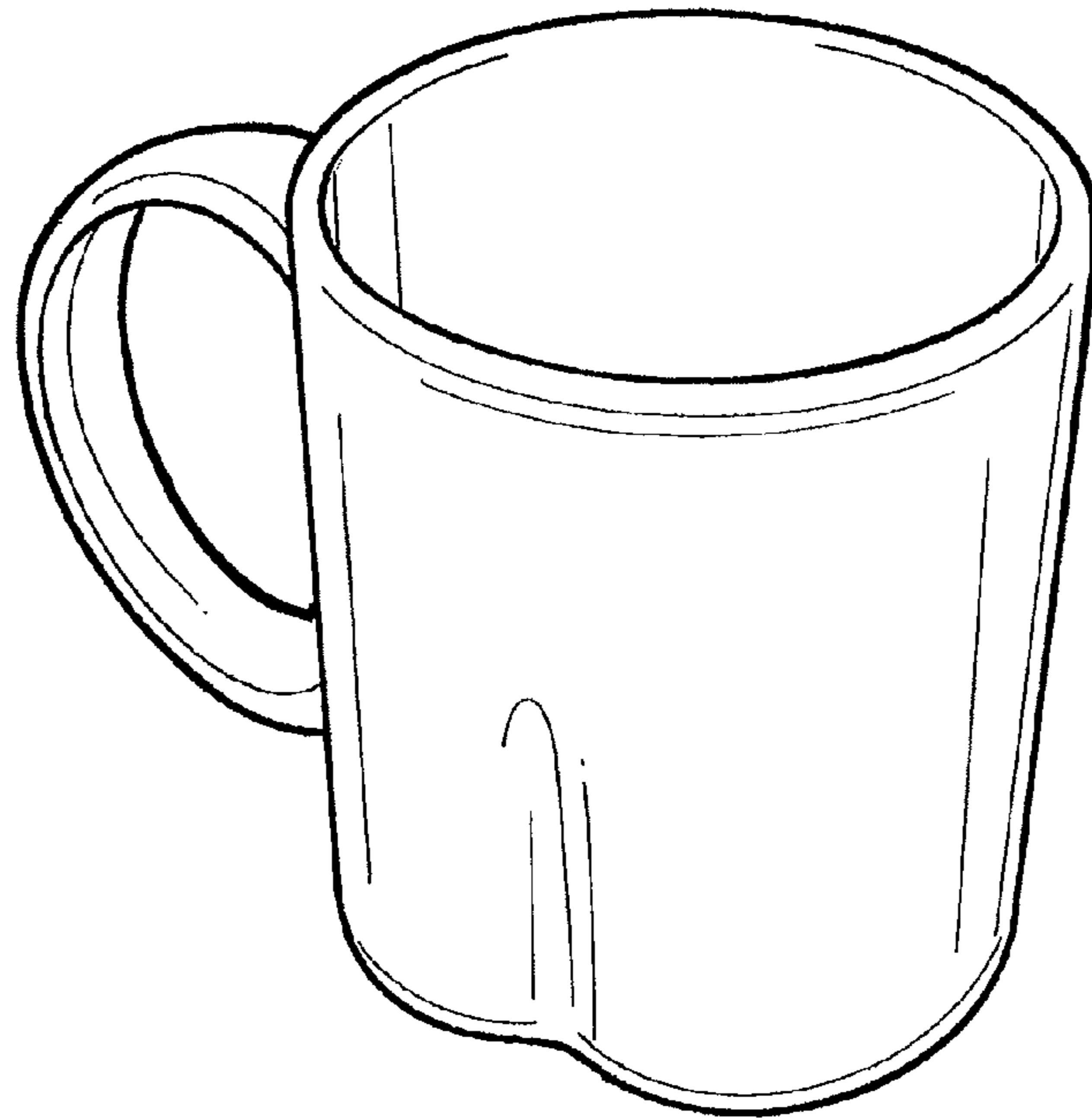

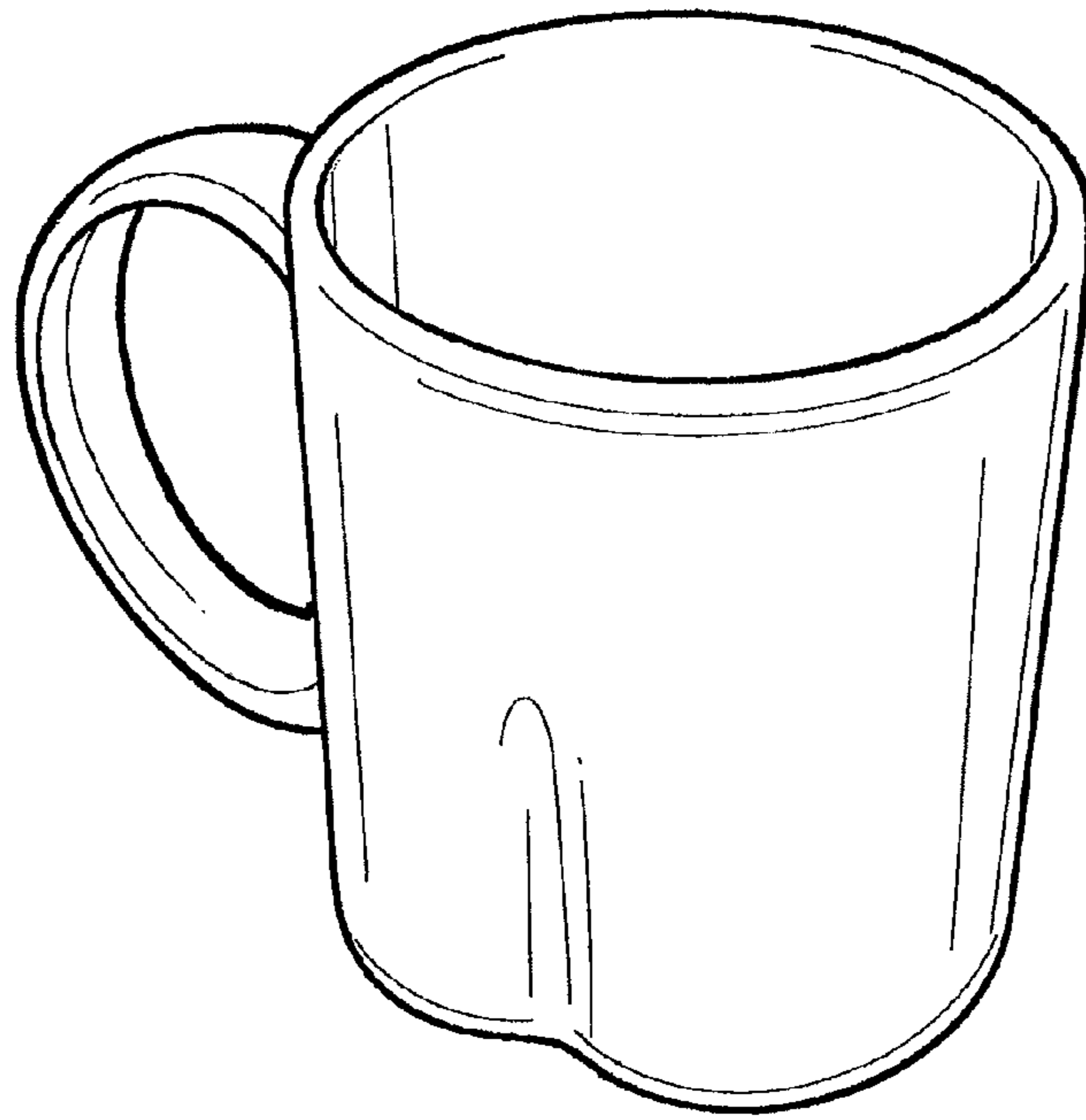

Fig. 1

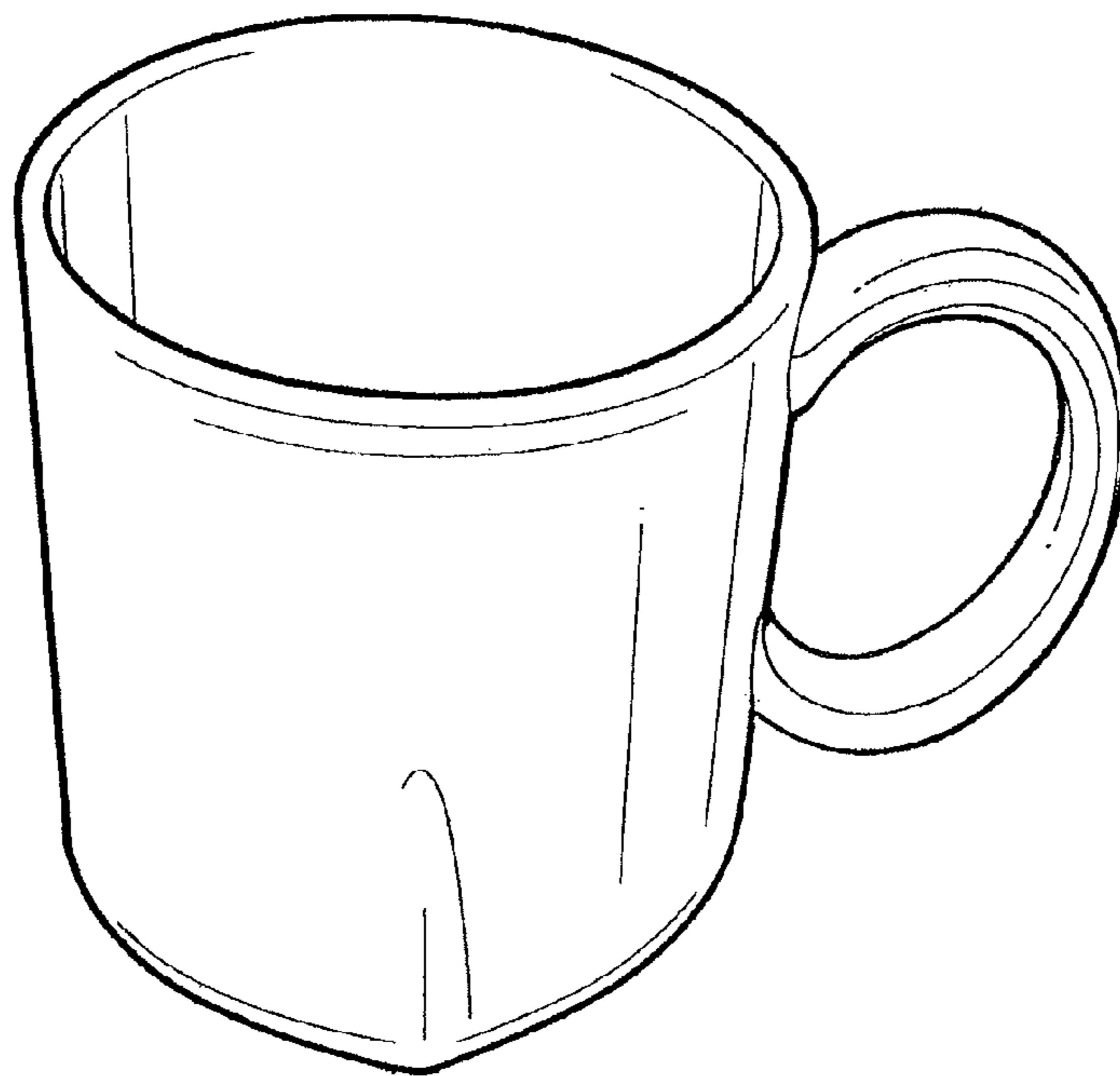

Fig. 2

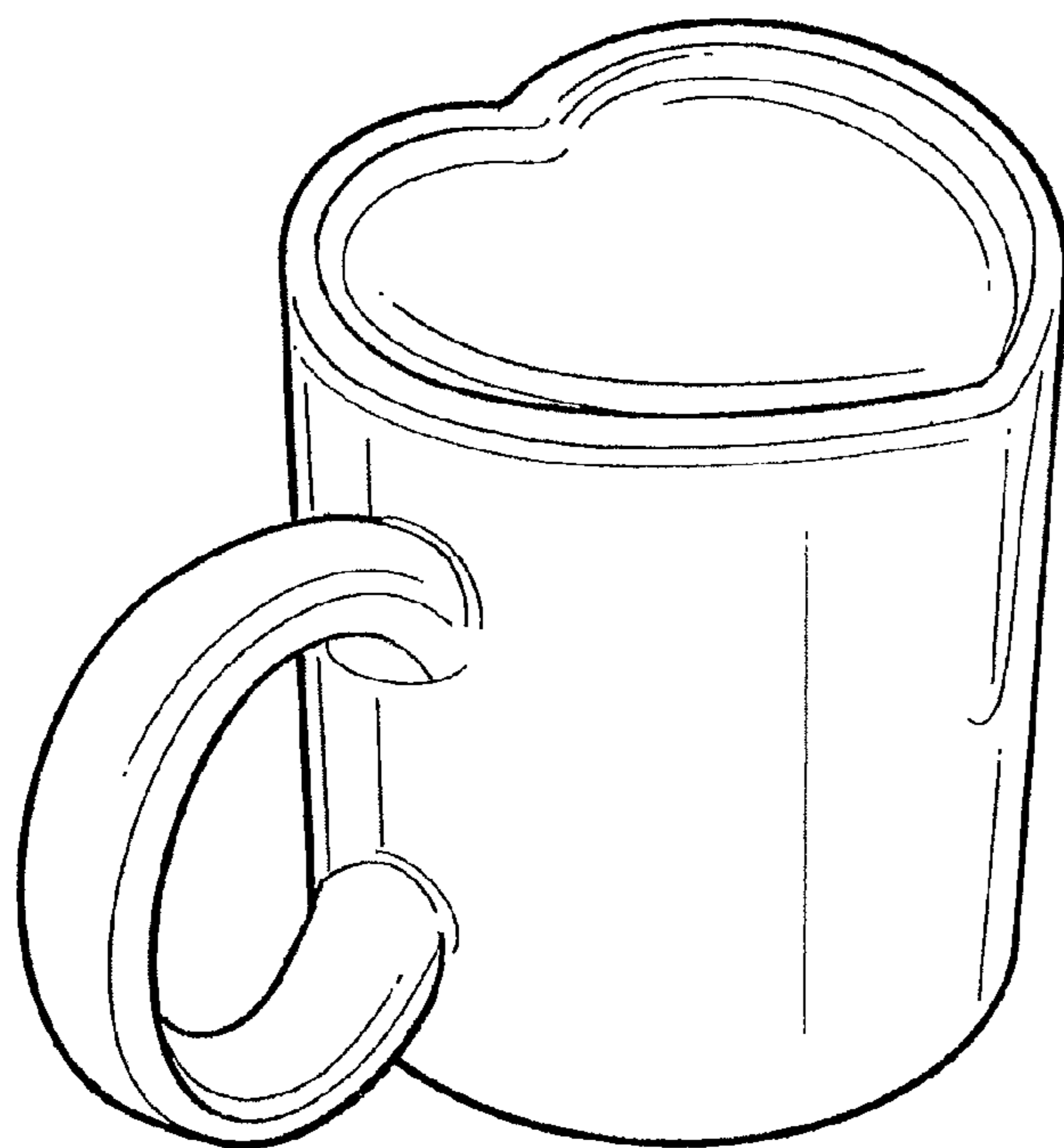

Fig. 3

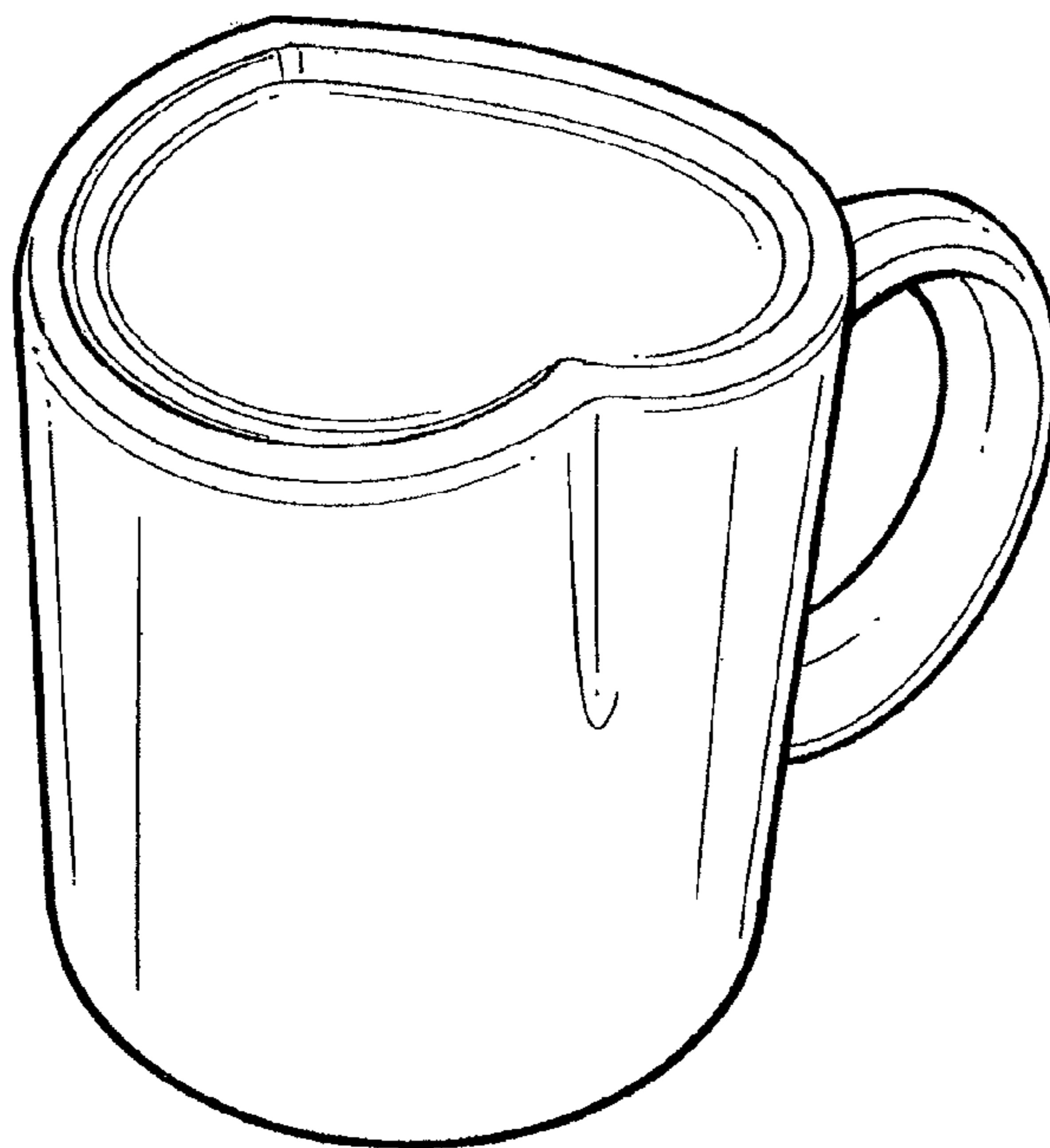

Fig. 4

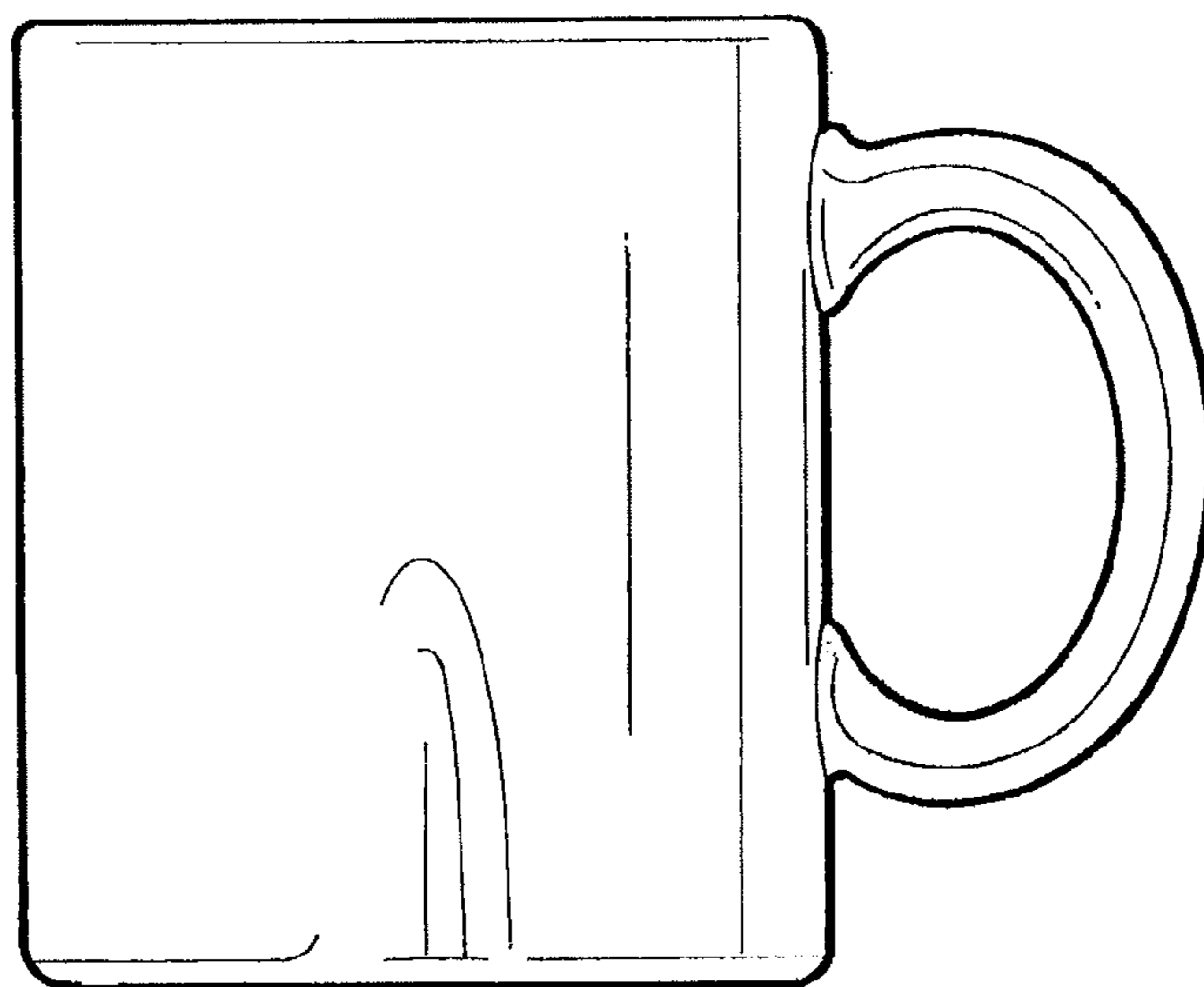

Fig. 5

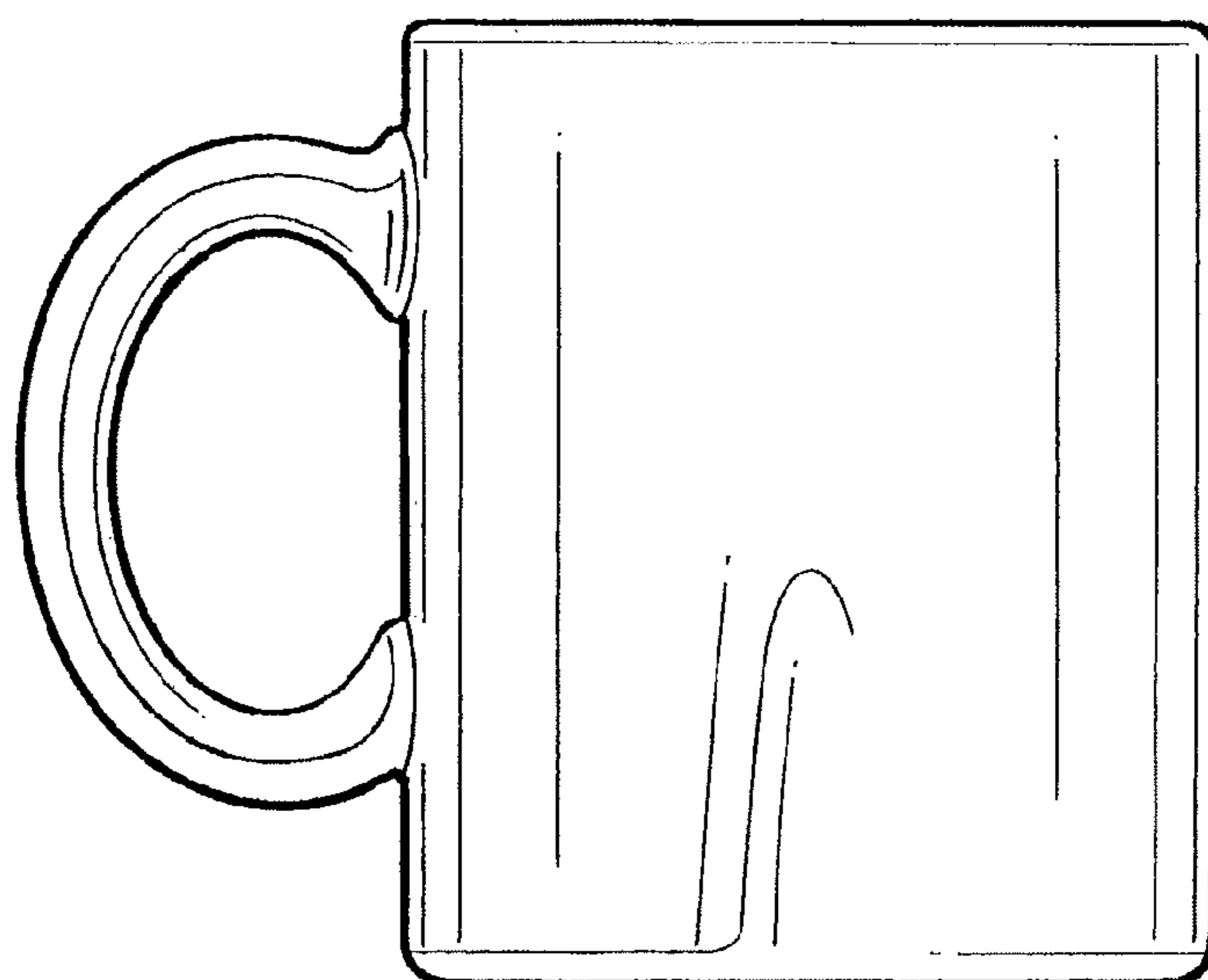

Fig. 6

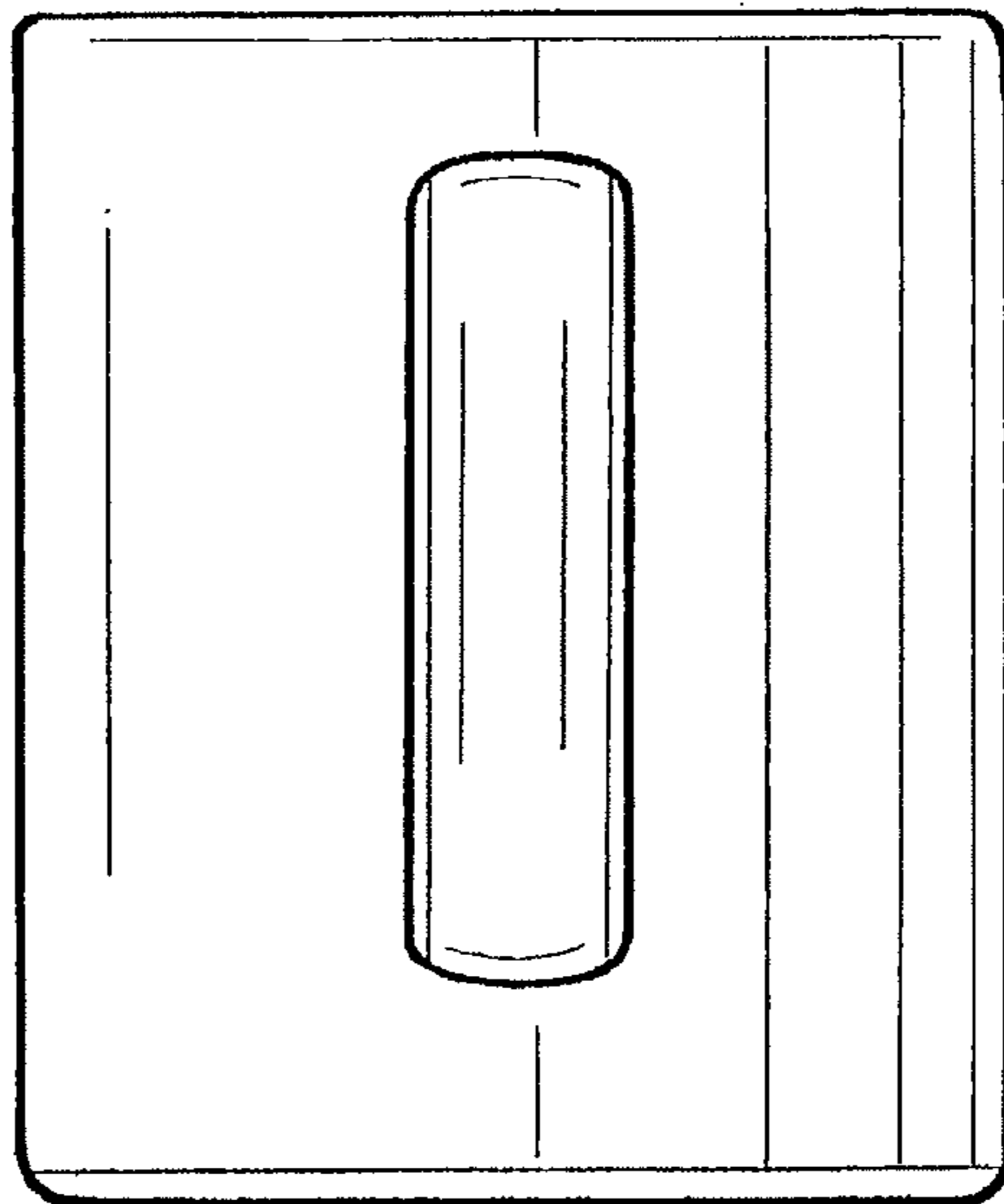

Fig. 7

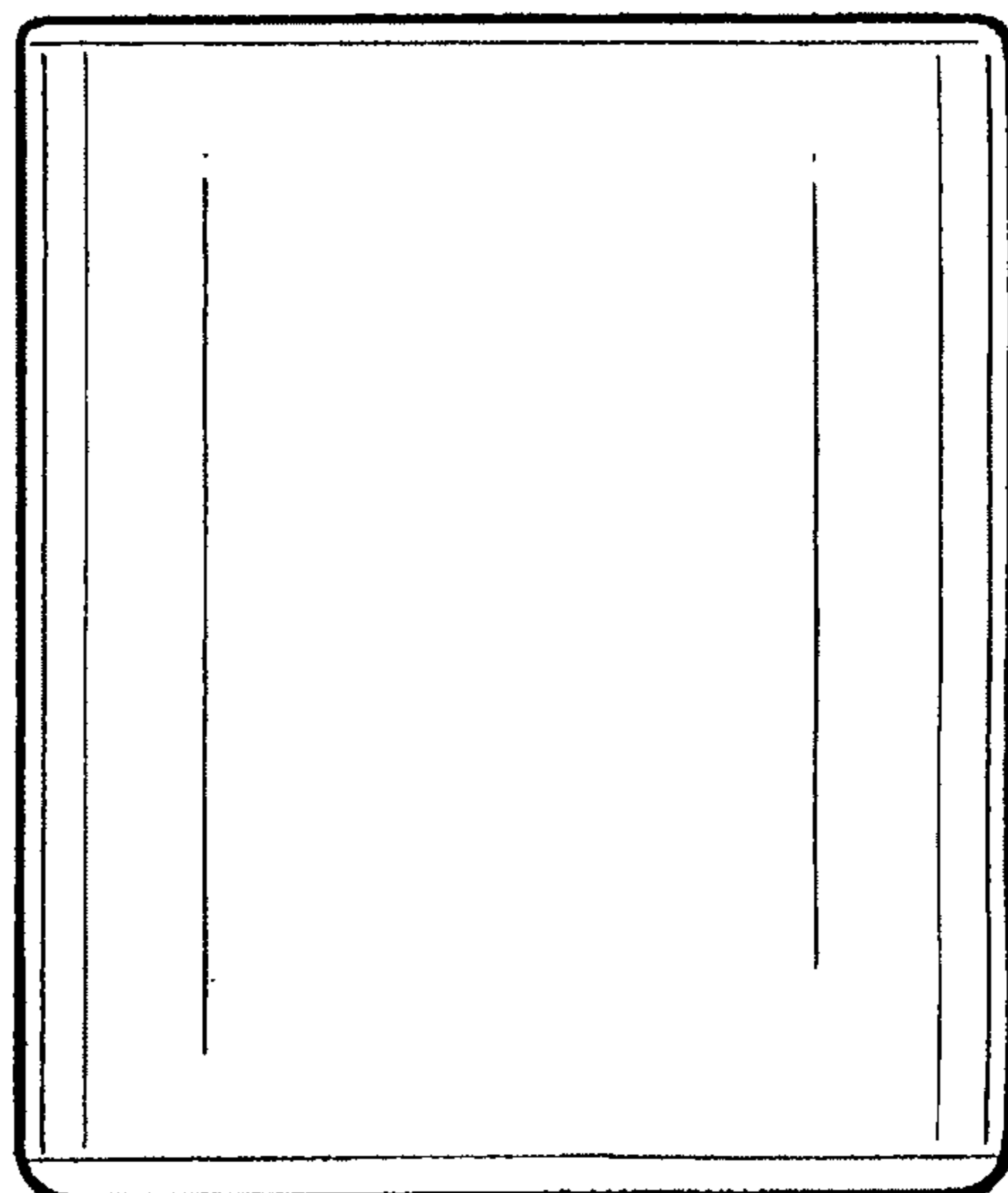

Fig. 8

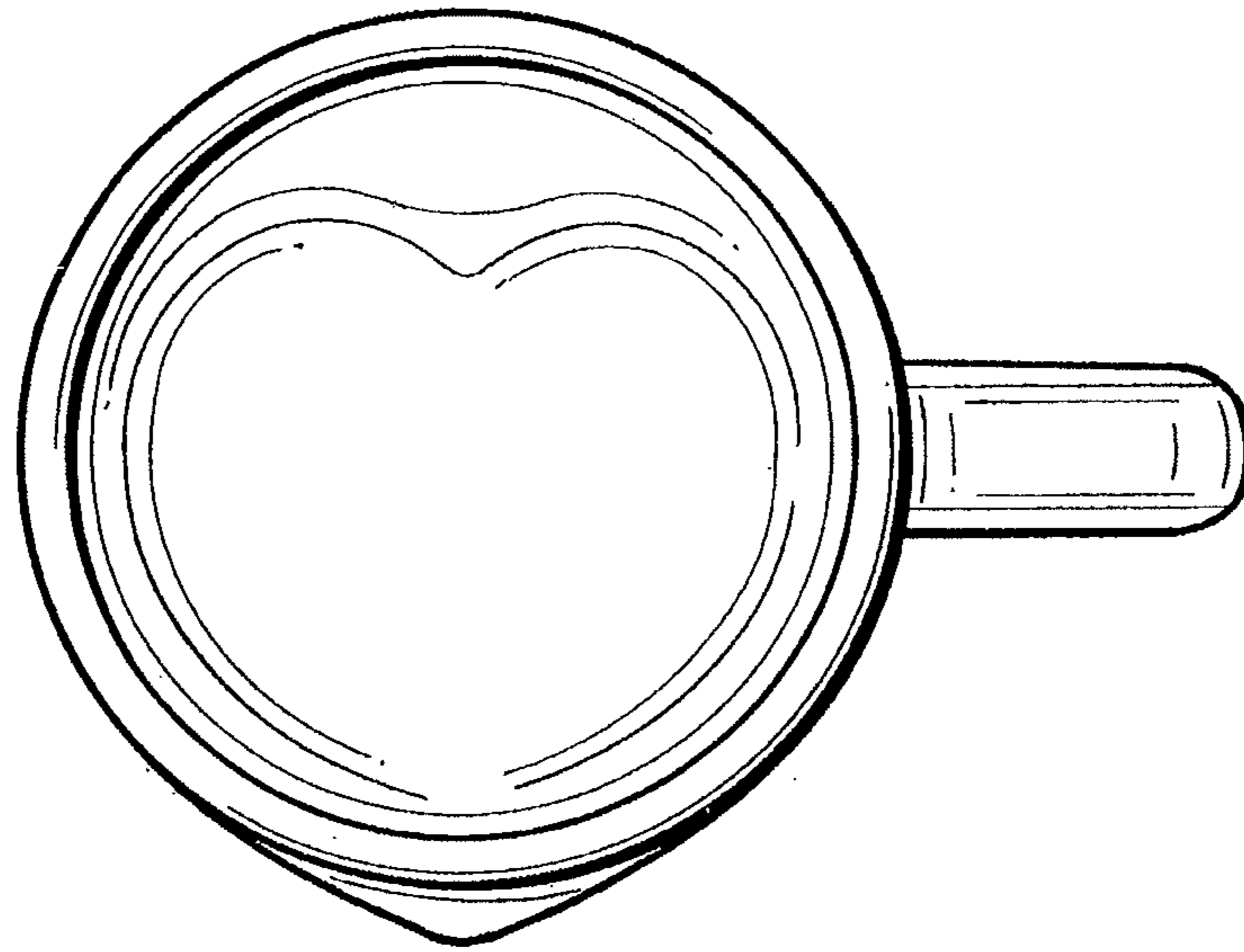

Fig. 9

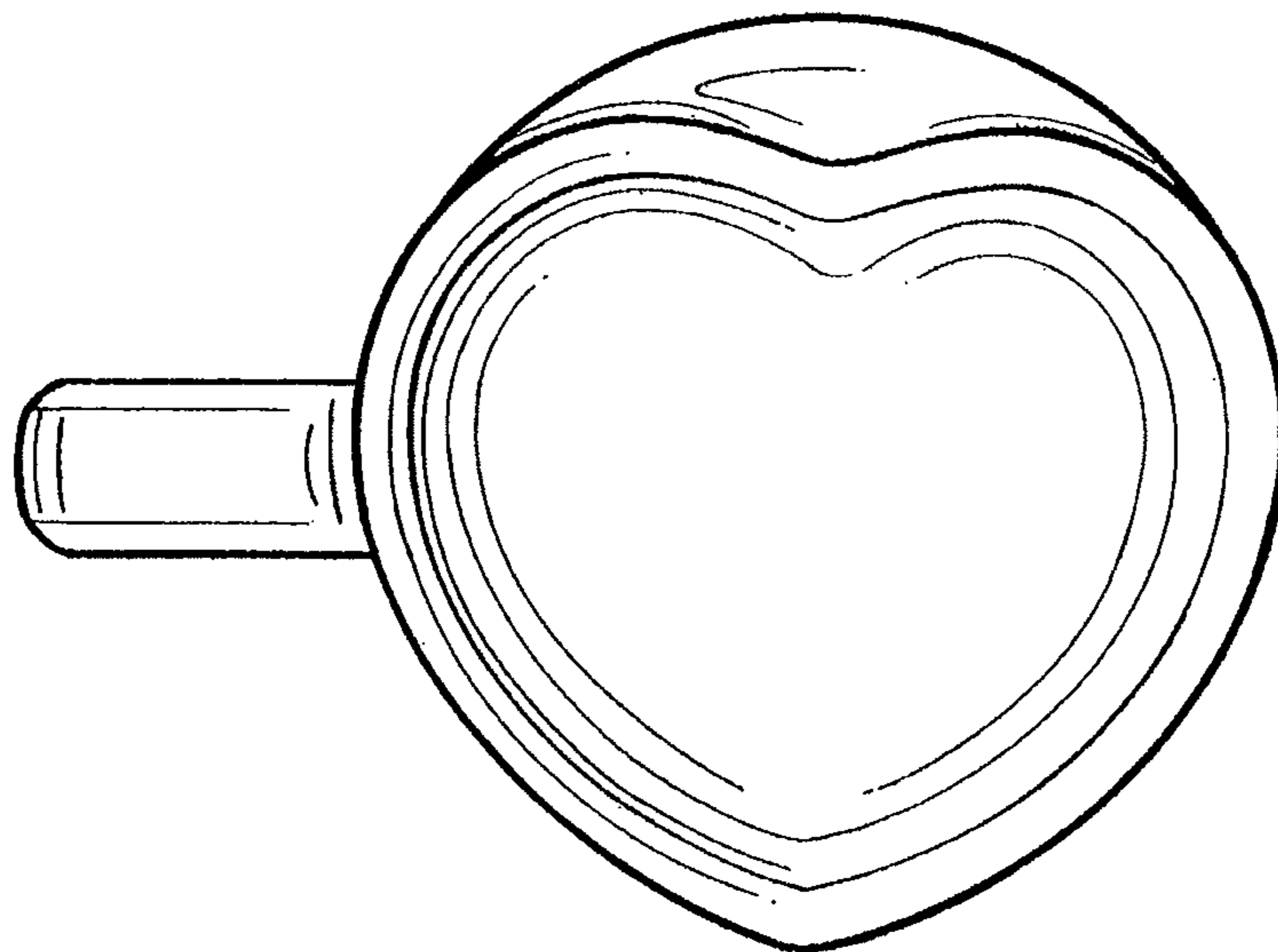

Fig. 10

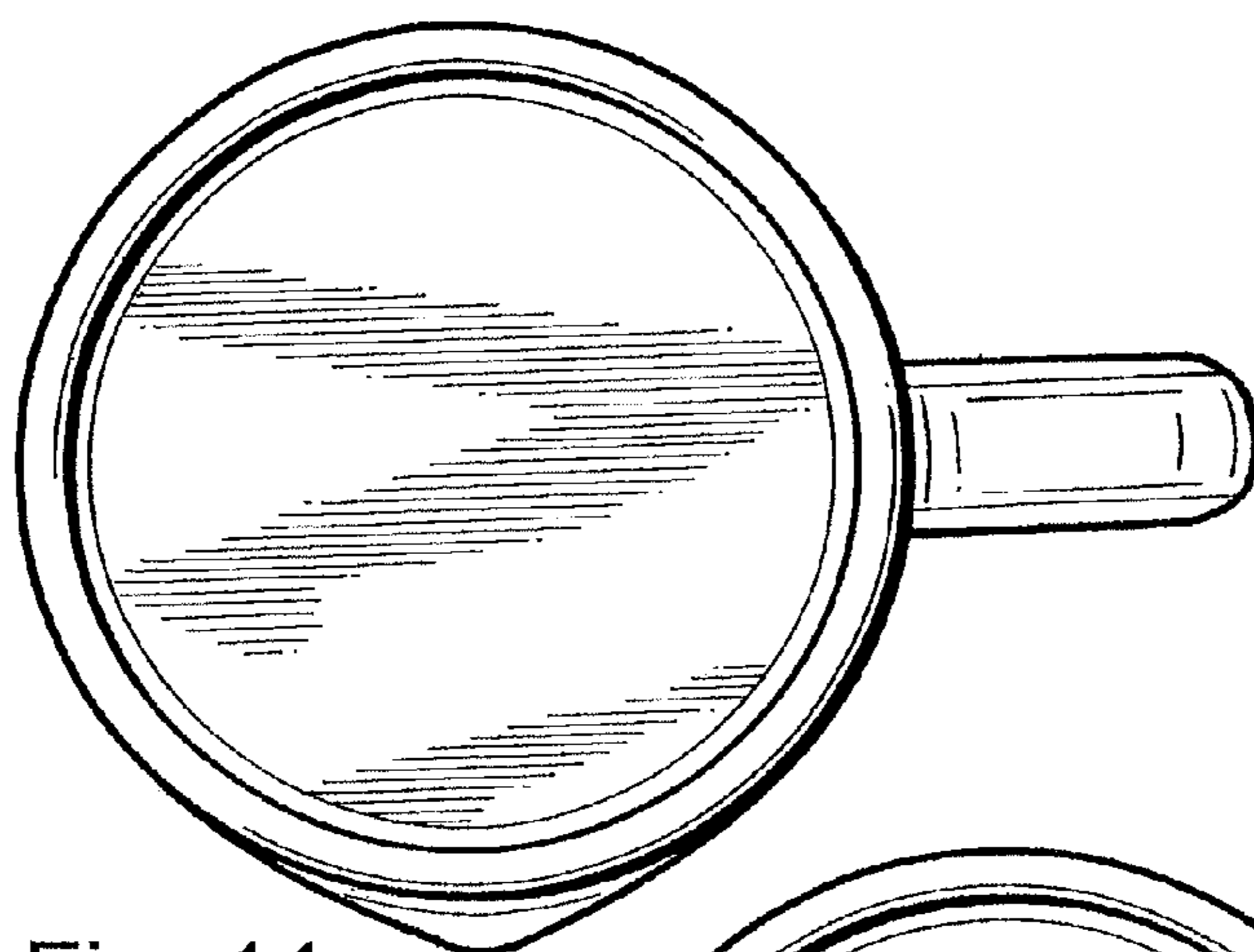

Fig. 11

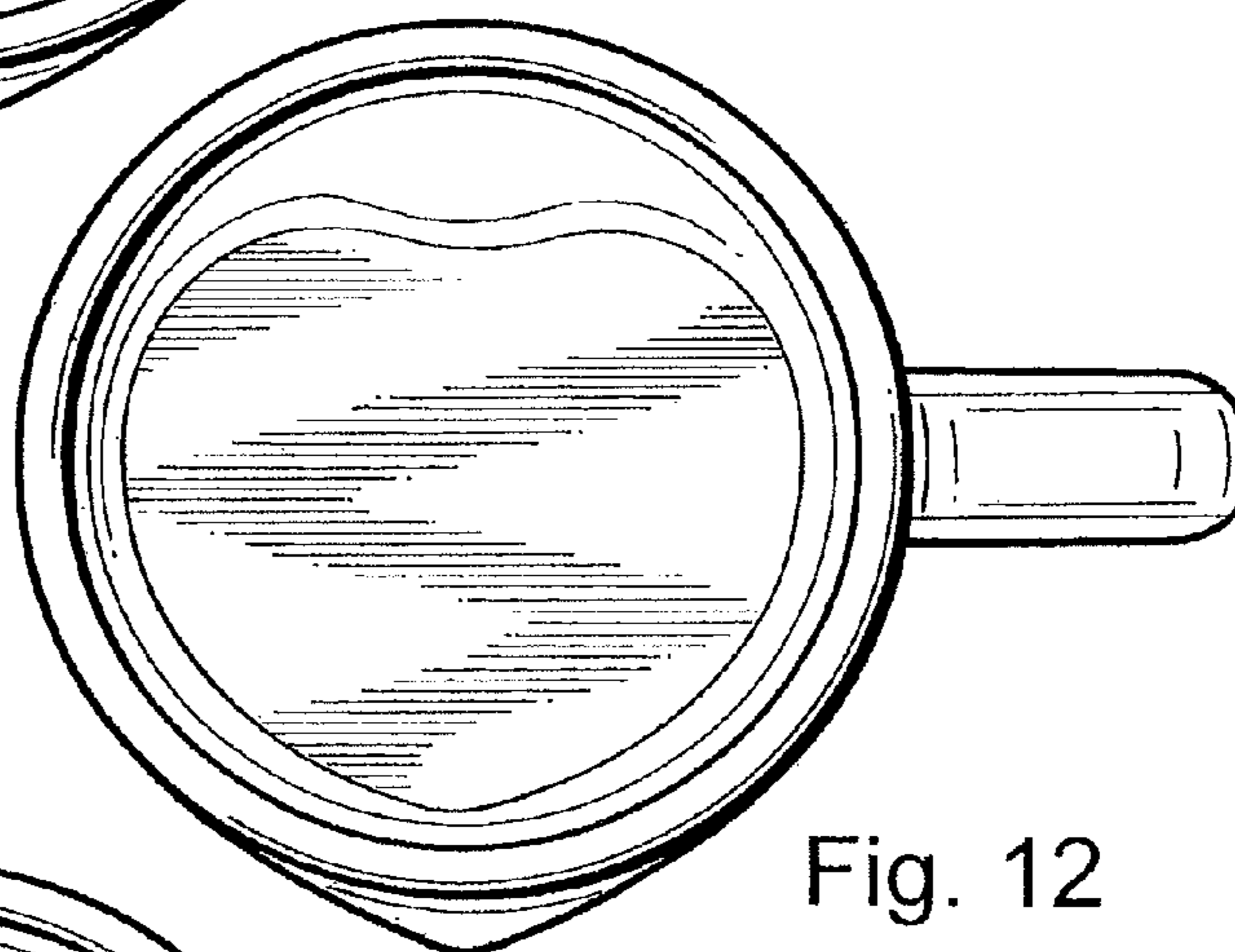

Fig. 12

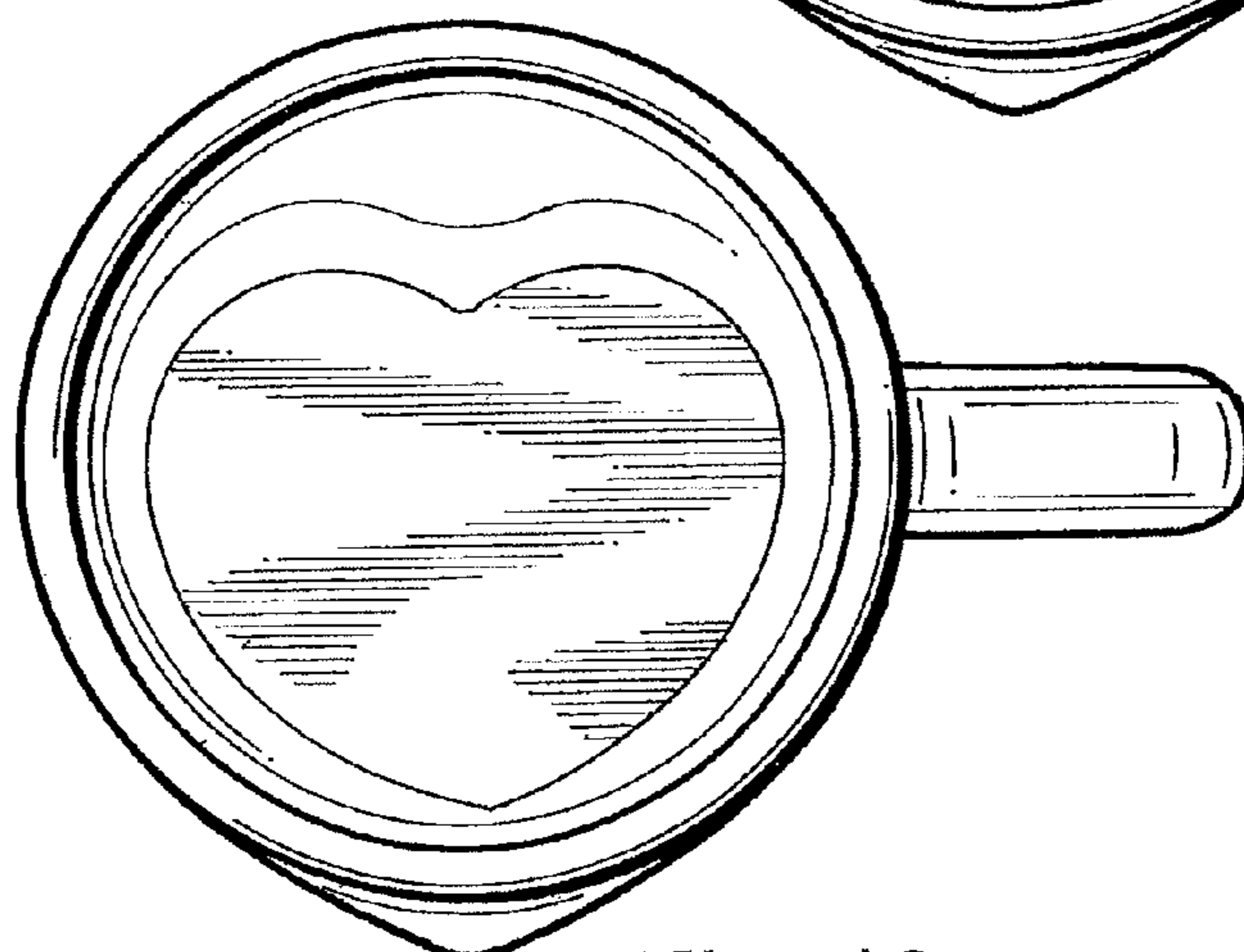

Fig. 13