



US00D704930S

(12) **United States Design Patent**
Murphy, Jr.

(10) **Patent No.:** **US D704,930 S**

(45) **Date of Patent:** **** May 20, 2014**

(54) **MEDICINE ORGANIZER**

(71) Applicant: **Levell Murphy, Jr.**, San Jose, CA (US)

(72) Inventor: **Levell Murphy, Jr.**, San Jose, CA (US)

(**) Term: **14 Years**

(21) Appl. No.: **29/452,245**

(22) Filed: **Apr. 15, 2013**

(51) **LOC (10) Cl.** **03-01**

(52) **U.S. Cl.**
USPC **D3/203.3**

(58) **Field of Classification Search**
USPC D3/201–205; 206/528–540;
D30/110–112; D22/123
See application file for complete search history.

(56) **References Cited**

U.S. PATENT DOCUMENTS

- 5,782,359 A * 7/1998 McAllister et al. 206/538
- D563,095 S * 3/2008 Sabbag D3/203.3
- D612,105 S * 3/2010 Capalbo D30/110

* cited by examiner

Primary Examiner — Catheri Oliver-Garcia

(74) *Attorney, Agent, or Firm* — Gulf Coast Intellectual Property Group

(57) **CLAIM**

The ornamental design for a medicine organizer, as shown and described.

DESCRIPTION

FIG. 1 is a perspective view of the present invention; and FIG. 2 is a left side view of the present invention; and FIG. 3 is a right side view of the present invention; and FIG. 4 is a top view of the present invention; and FIG. 5 is a perspective view of the present invention with a door and a drawer in an open position; and, FIG. 6 is a bottom view of the present invention. Wherein the dotted lines illustrate use and environment and form no part of the claimed design.

1 Claim, 3 Drawing Sheets

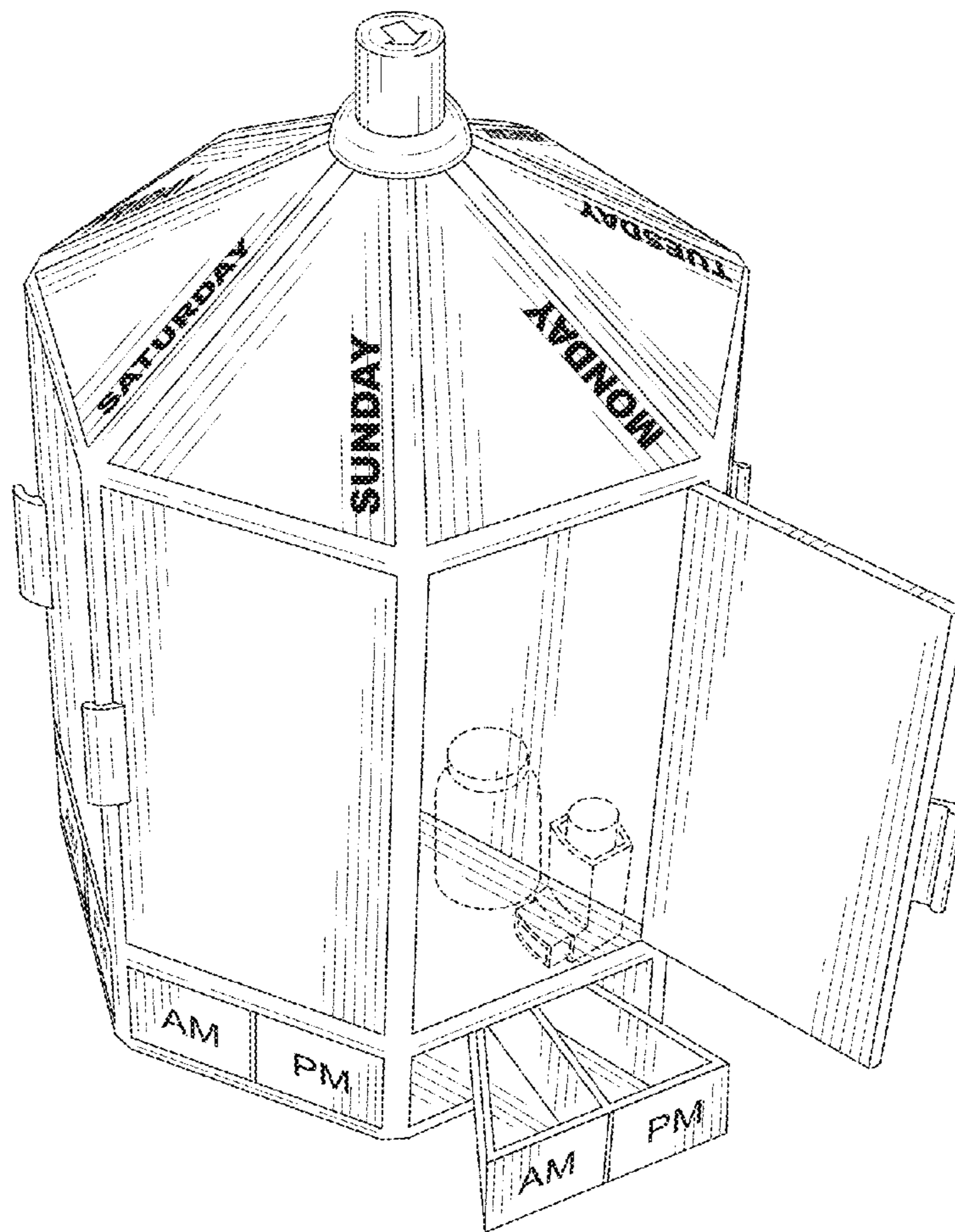

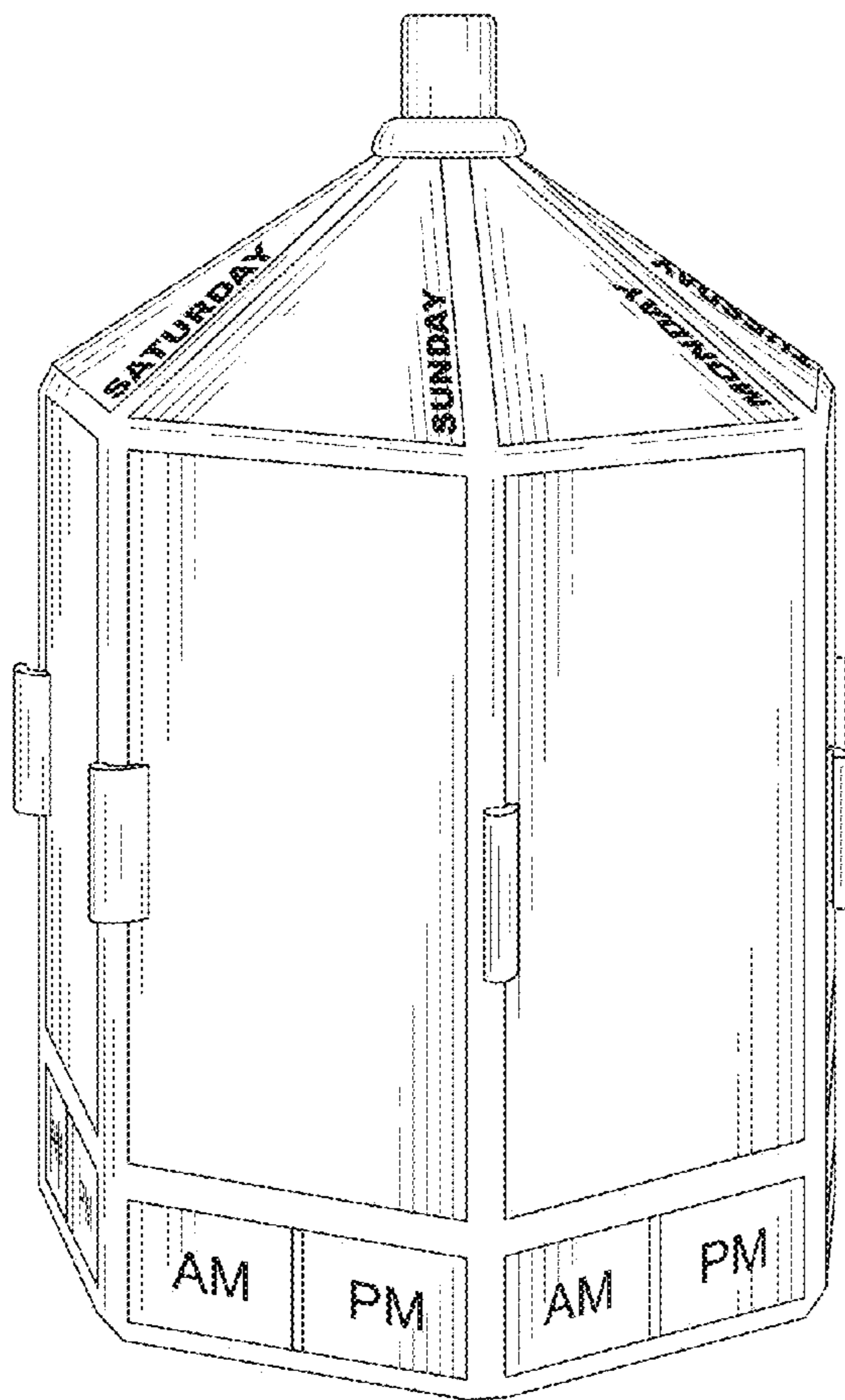

FIG. 1

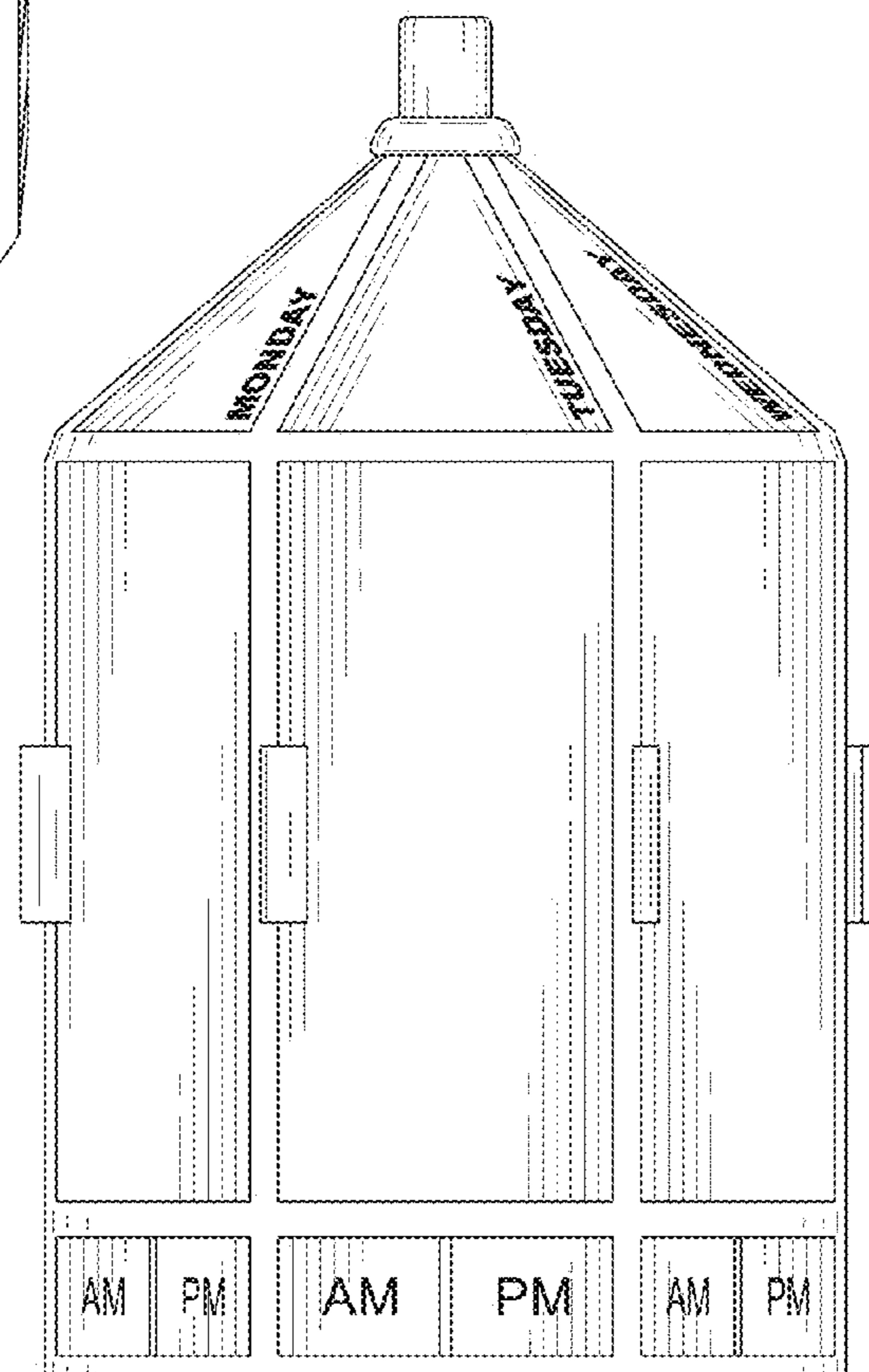

FIG. 2

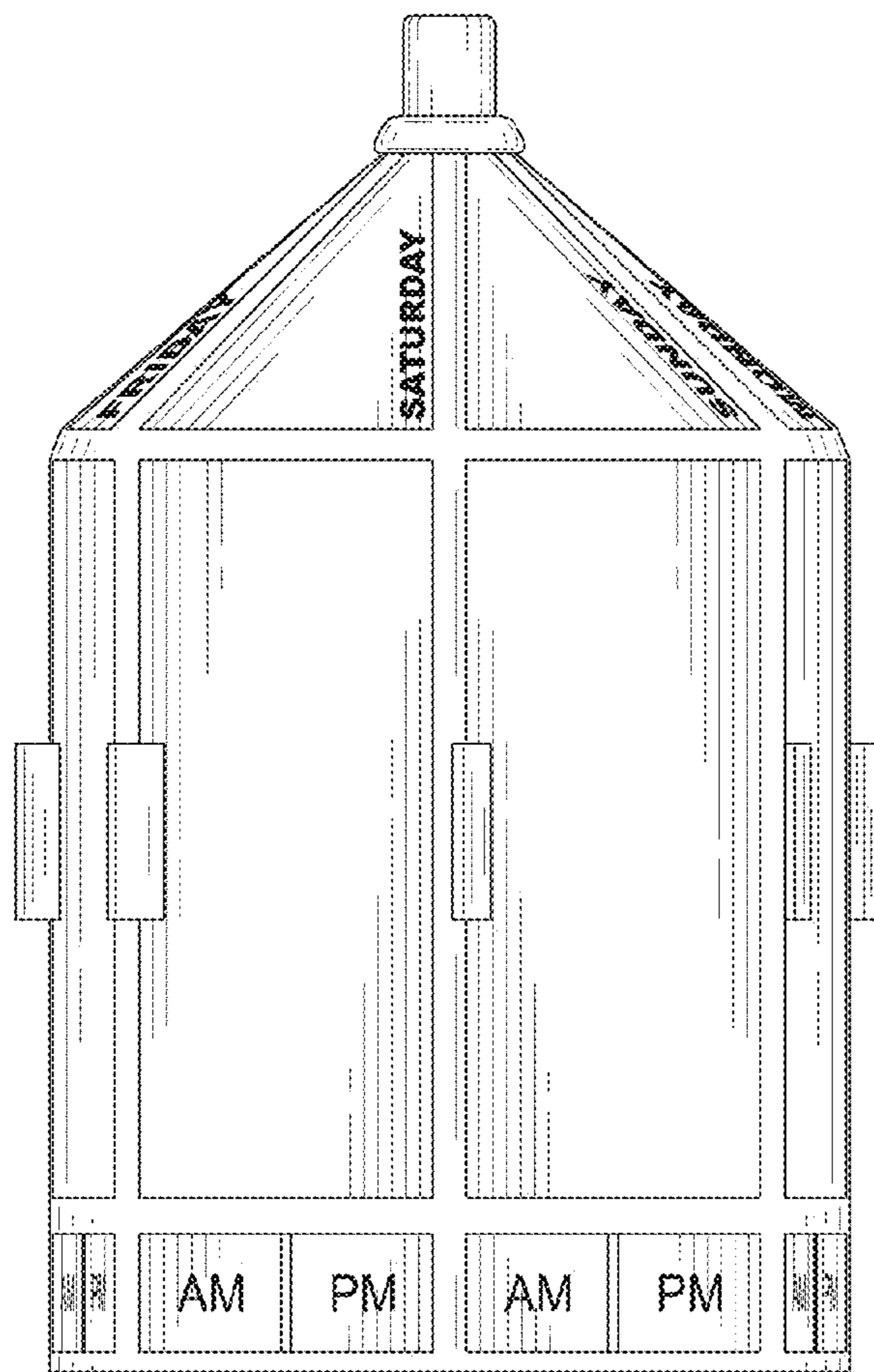

FIG. 3

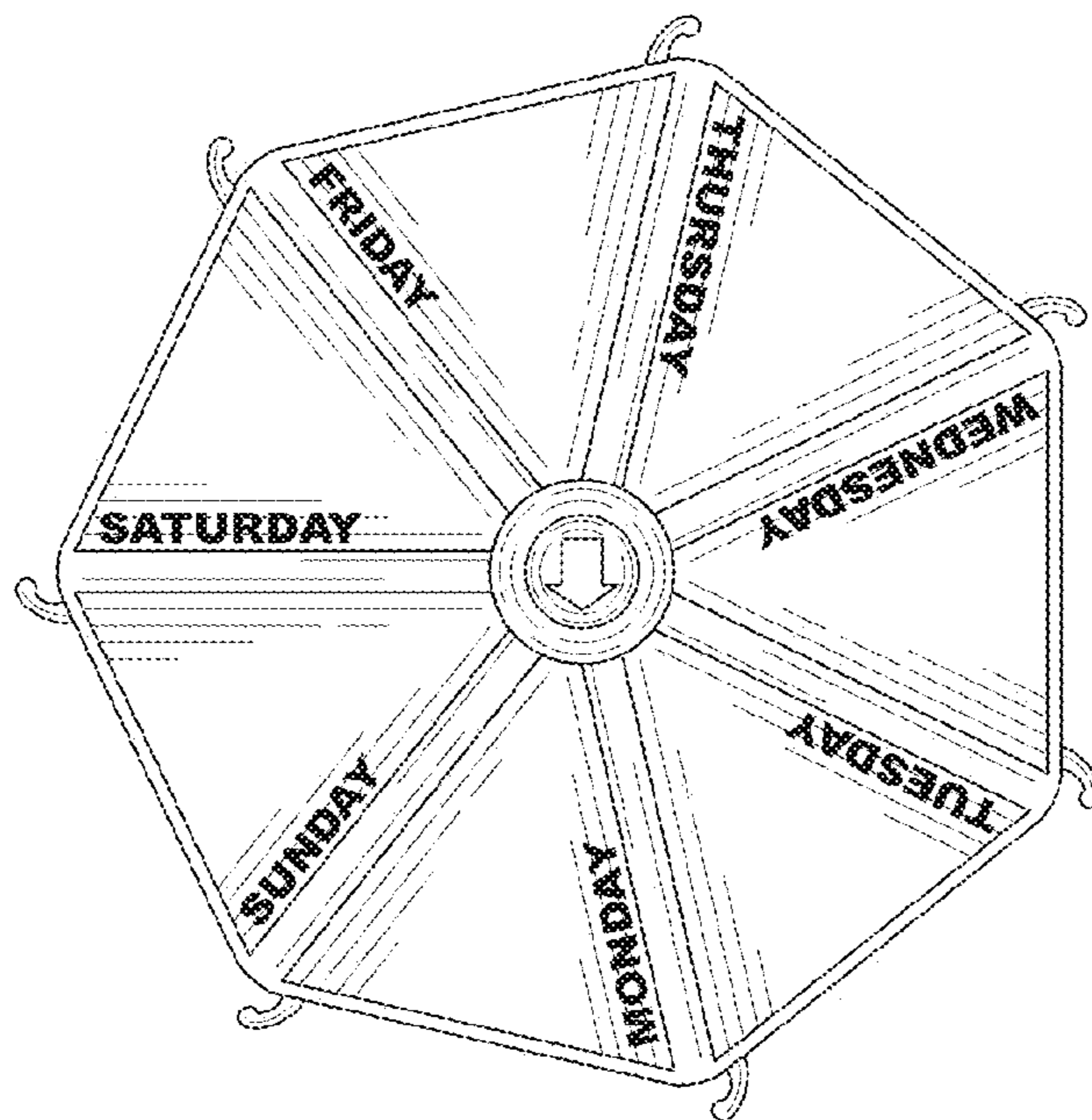

FIG. 4

