



US00D704922S

(12) **United States Design Patent**
Hodges

(10) **Patent No.:** **US D704,922 S**

(45) **Date of Patent:** **** May 20, 2014**

(54) **UNDERGARMENT FOR MEDICAL PATIENT**

(71) Applicant: **Shirley Hodges**, Owensboro, KY (US)

(72) Inventor: **Shirley Hodges**, Owensboro, KY (US)

(**) Term: **14 Years**

(21) Appl. No.: **29/469,718**

(22) Filed: **Oct. 14, 2013**

(51) **LOC (10) Cl.** **02-01**

(52) **U.S. Cl.**
USPC **D2/712**

(58) **Field of Classification Search**
USPC D2/712, 713, 714, 715, 716, 731, 736,
D2/737, 738, 739; 2/67, 228, 234, 235,
2/236, 237, 238, 401, 402, 403, 404, 405,
2/406, 407, 408

See application file for complete search history.

(56) **References Cited**

U.S. PATENT DOCUMENTS

1,077,264	A *	11/1913	Earnshaw	2/111
2,520,026	A *	8/1950	Beitchman	2/227
D311,632	S *	10/1990	Beam	D2/712
D417,940	S *	12/1999	Coates et al.	D2/713
D537,525	S *	2/2007	Buchanan	D24/124
D585,182	S	1/2009	Hodges et al.		
D591,928	S *	5/2009	Kirsch et al.	D2/712
D608,528	S *	1/2010	Tonetti-Spellman	D2/742
7,716,755	B1 *	5/2010	Wiens	2/466
D679,070	S	4/2013	Denning		
2005/0235399	A1 *	10/2005	Kang	2/403
2006/0162052	A1 *	7/2006	Stankowski et al.	2/403
2009/0100569	A1 *	4/2009	Butler	2/114
2012/0053553	A1 *	3/2012	Griggs	604/396
2012/0060264	A1 *	3/2012	Wilkins	2/406
2013/0219591	A1 *	8/2013	Gu	2/405
2013/0263359	A1 *	10/2013	Wong	2/228

* cited by examiner

Primary Examiner — Karen E Eldridge Powers

(74) *Attorney, Agent, or Firm* — Woodard, Emhardt, Moriarty, McNett & Henry LLP

(57) **CLAIM**

The ornamental design for a undergarment for medical patient, as shown and described.

DESCRIPTION

FIG. 1 is a top perspective view of a first embodiment of an undergarment showing my new design;
 FIG. 2 is a front elevation view thereof;
 FIG. 3 is a rear elevation view thereof;
 FIG. 4 is a top plan view thereof;
 FIG. 5 is a bottom plan view thereof;
 FIG. 6 is a right side elevation view thereof;
 FIG. 7 is a left side elevation view thereof;
 FIG. 8 is an interior plan view of the undergarment of FIG. 1 laid flat;
 FIG. 9 is an exterior plan view of the undergarment of FIG. 1 laid flat;
 FIG. 10 is a top perspective view of a second embodiment of an undergarment showing my new design;
 FIG. 11 is a front elevation view of the undergarment of FIG. 10;
 FIG. 12 is a rear elevation view of FIG. 10;
 FIG. 13 is a top plan view of FIG. 10;
 FIG. 14 is a bottom plan view of FIG. 10;
 FIG. 15 is a right side elevation view of FIG. 10;
 FIG. 16 is a left side elevation view of FIG. 10;
 FIG. 17 is an interior plan view of the undergarment of FIG. 10 laid flat; and,
 FIG. 18 is an exterior plan view of the undergarment of FIG. 10 laid flat.

1 Claim, 16 Drawing Sheets

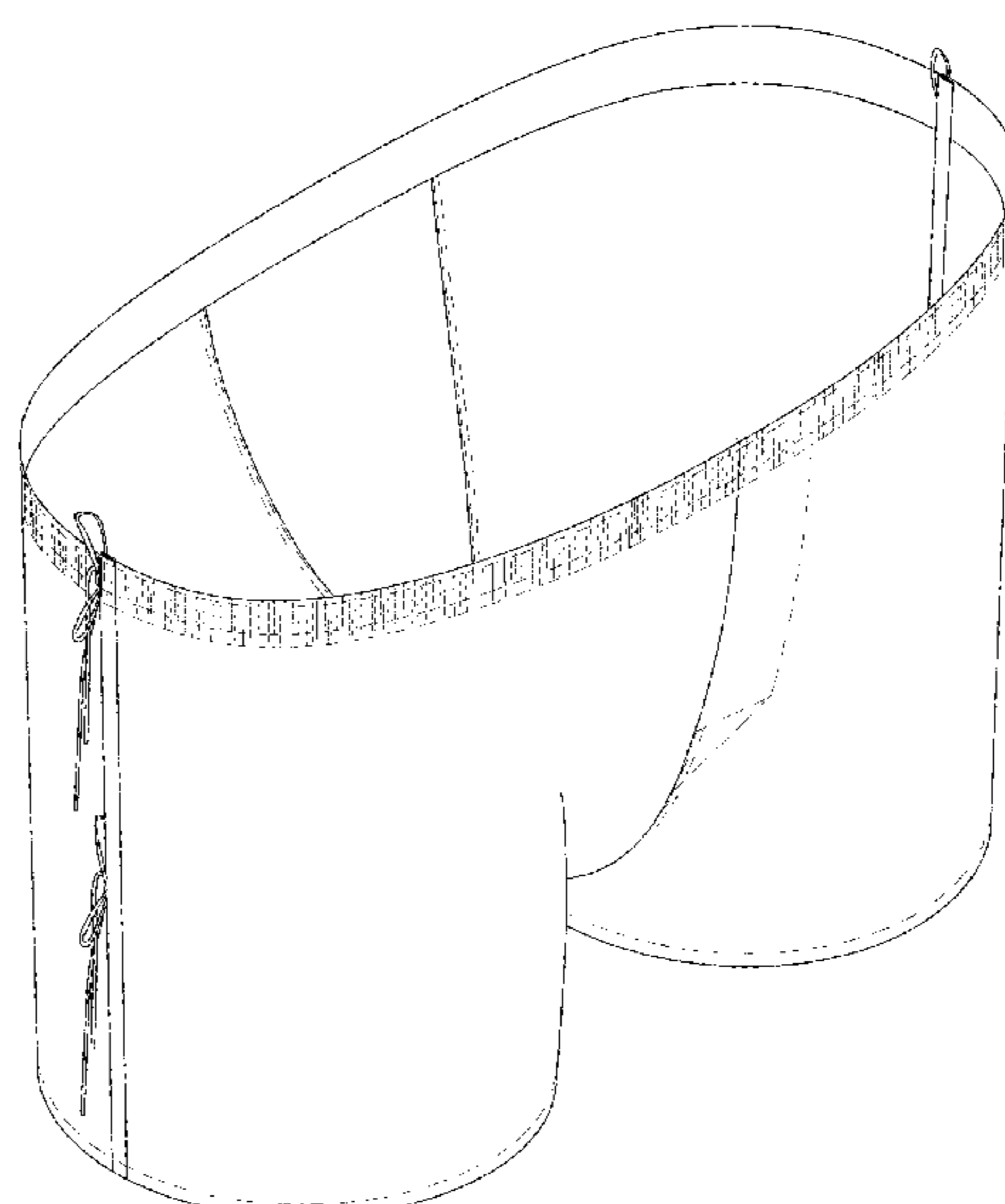
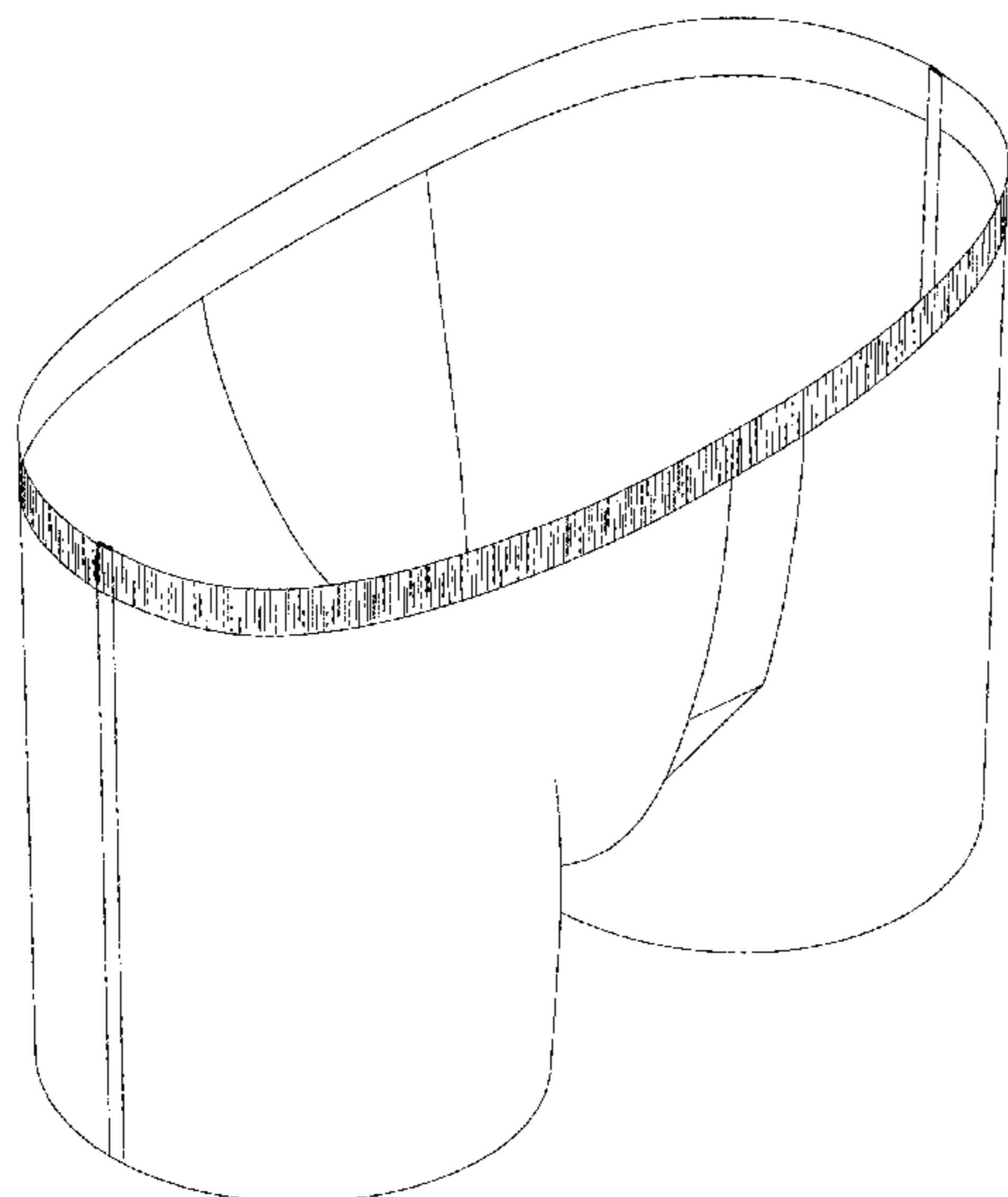

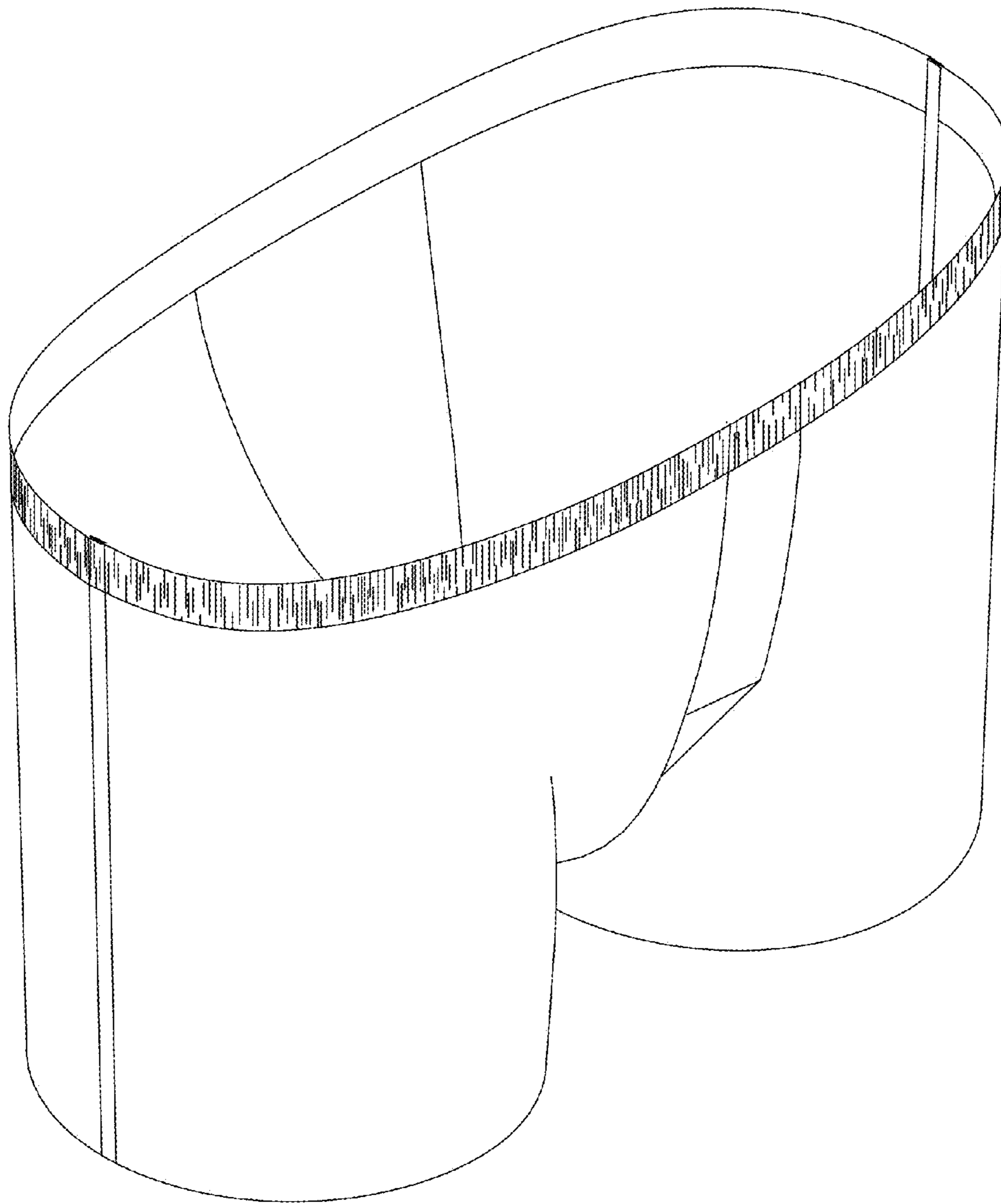

Fig. 1

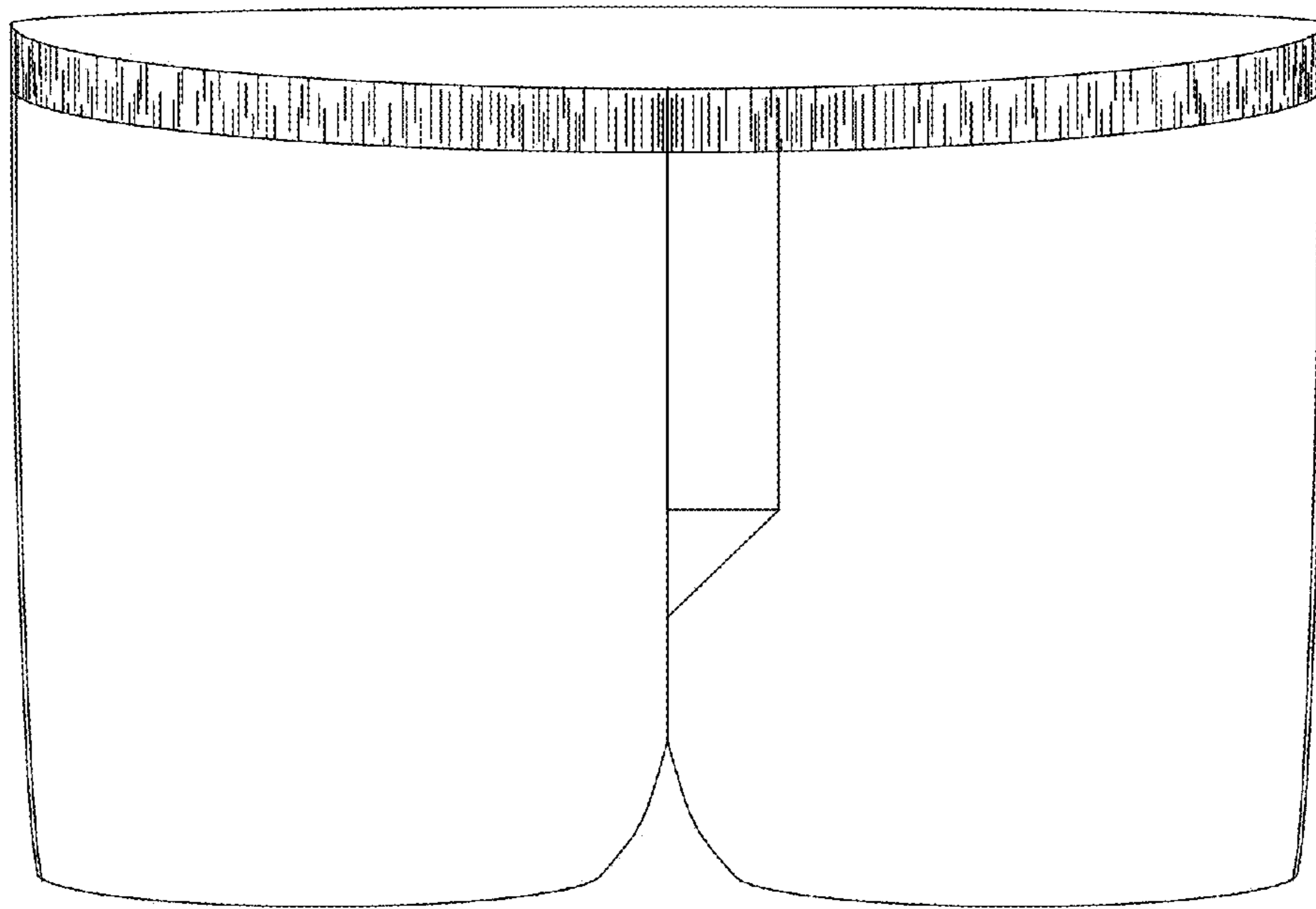

Fig. 2

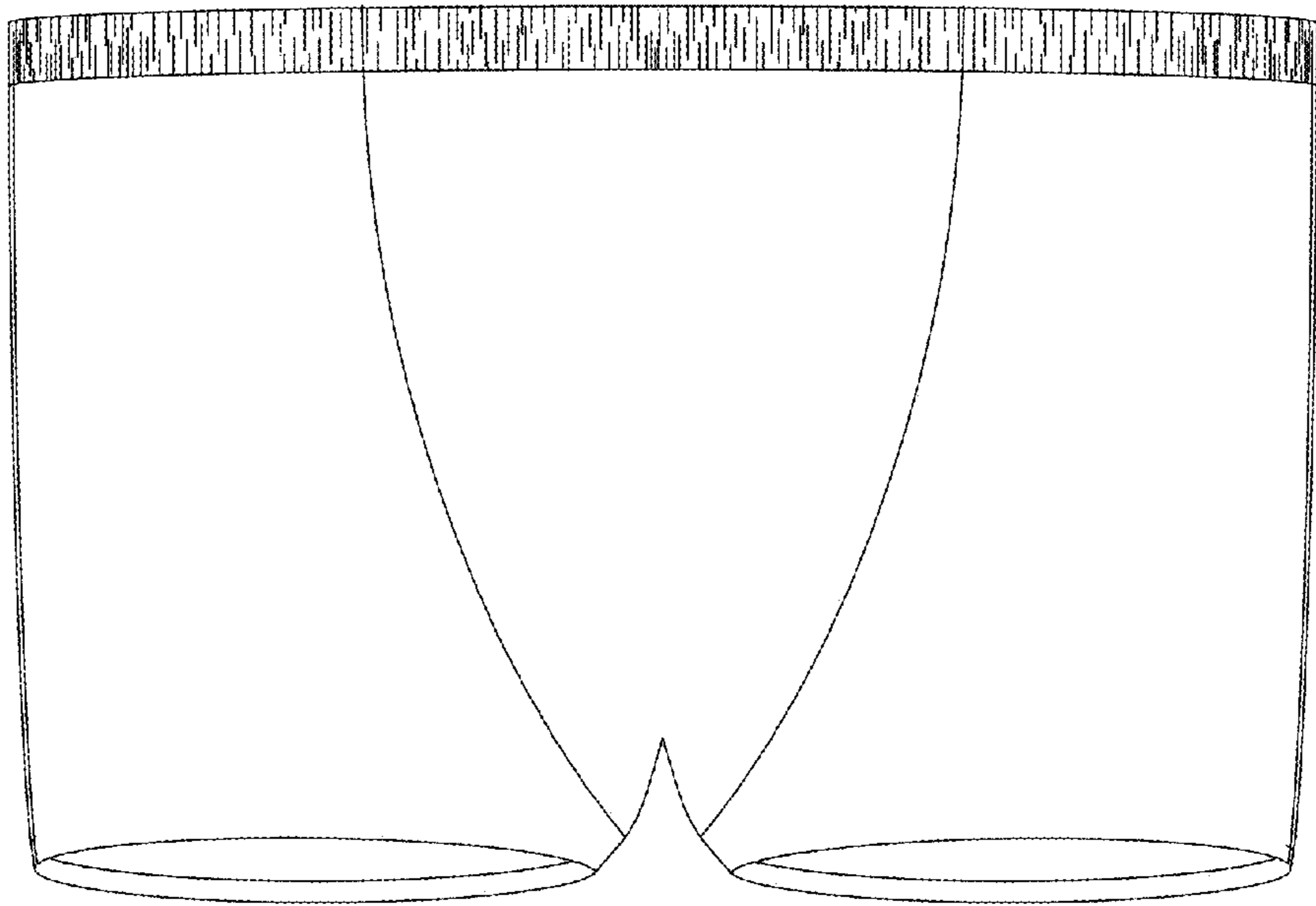

Fig. 3

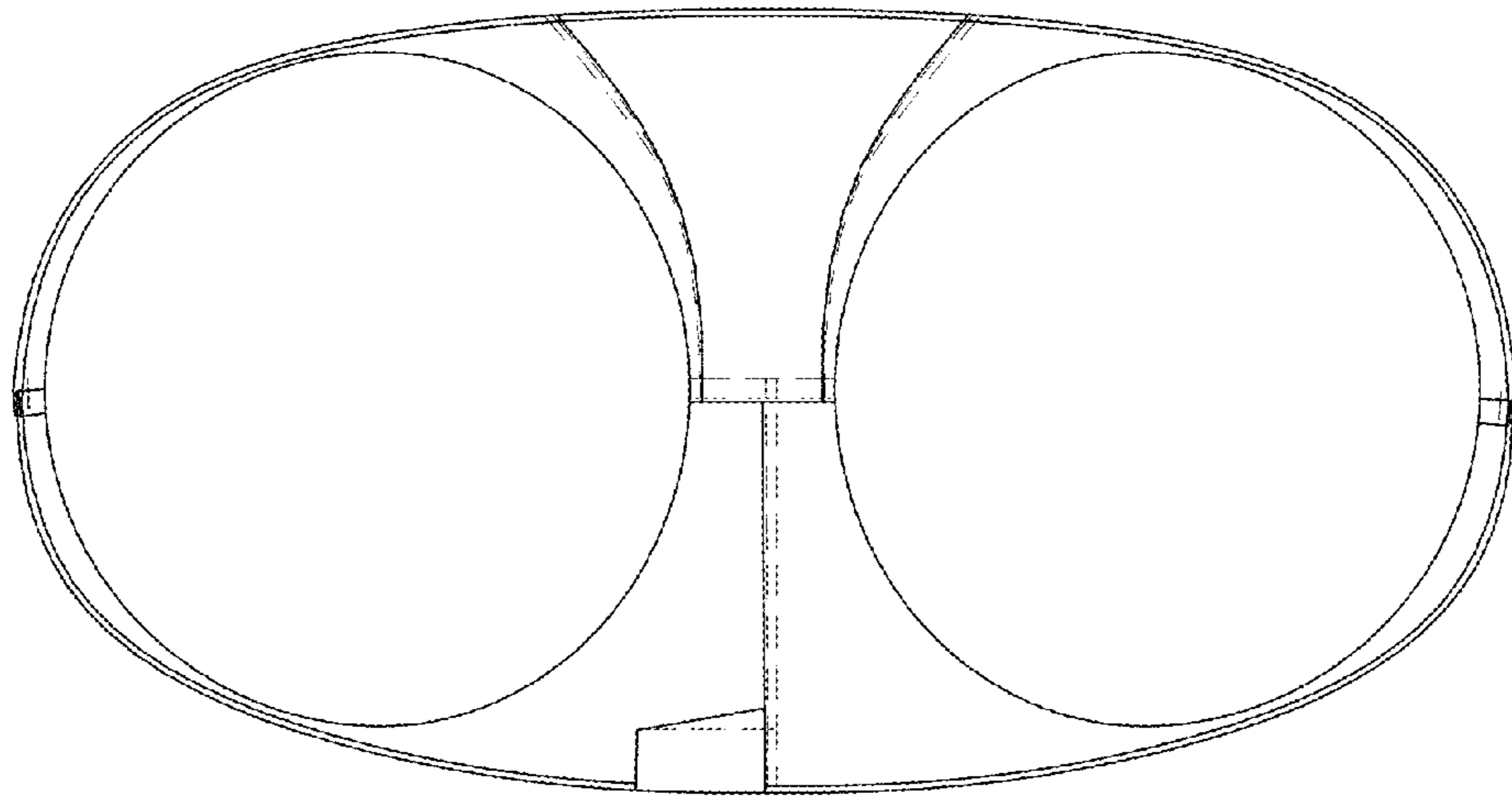

Fig. 4

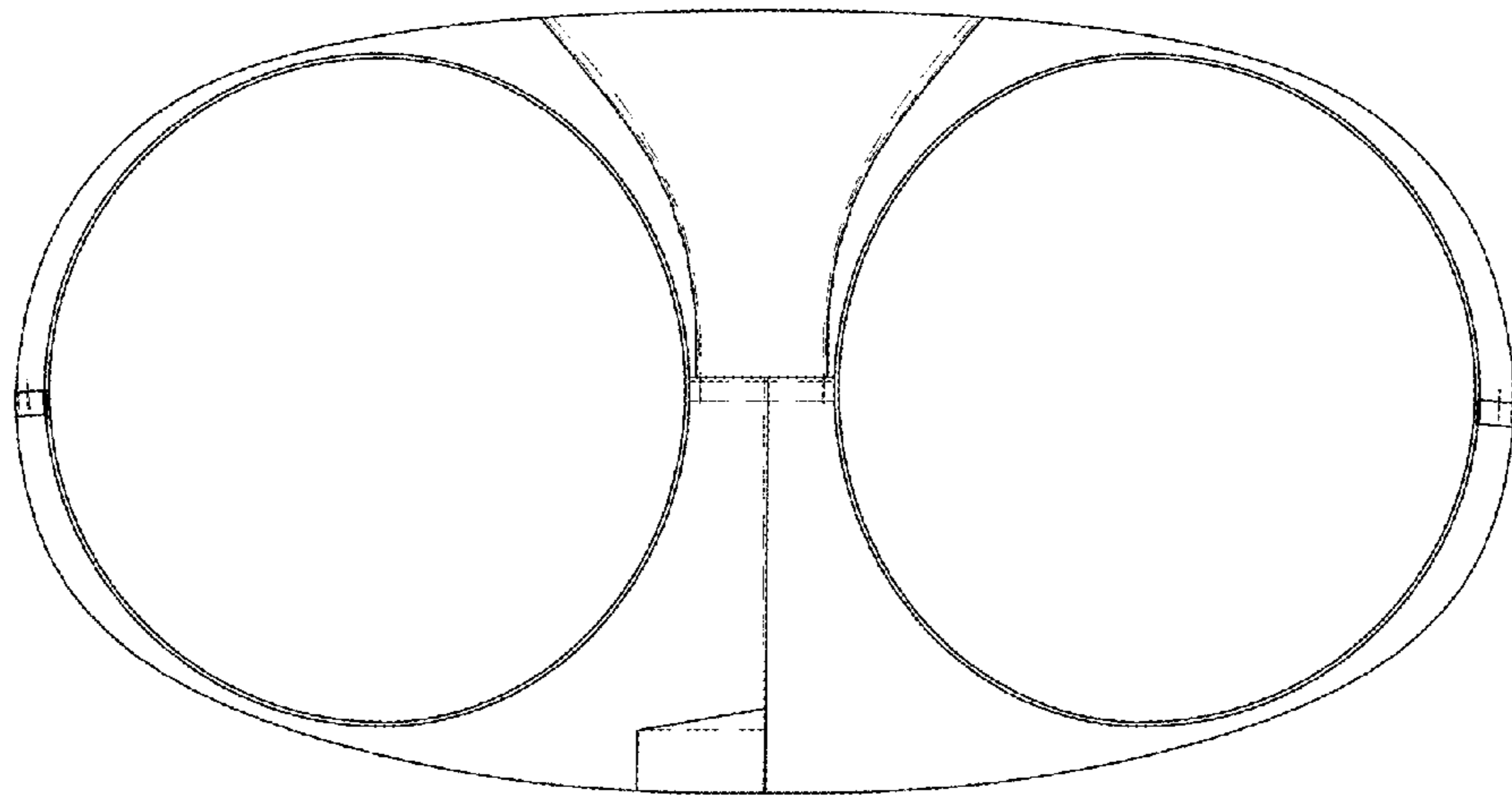

Fig. 5

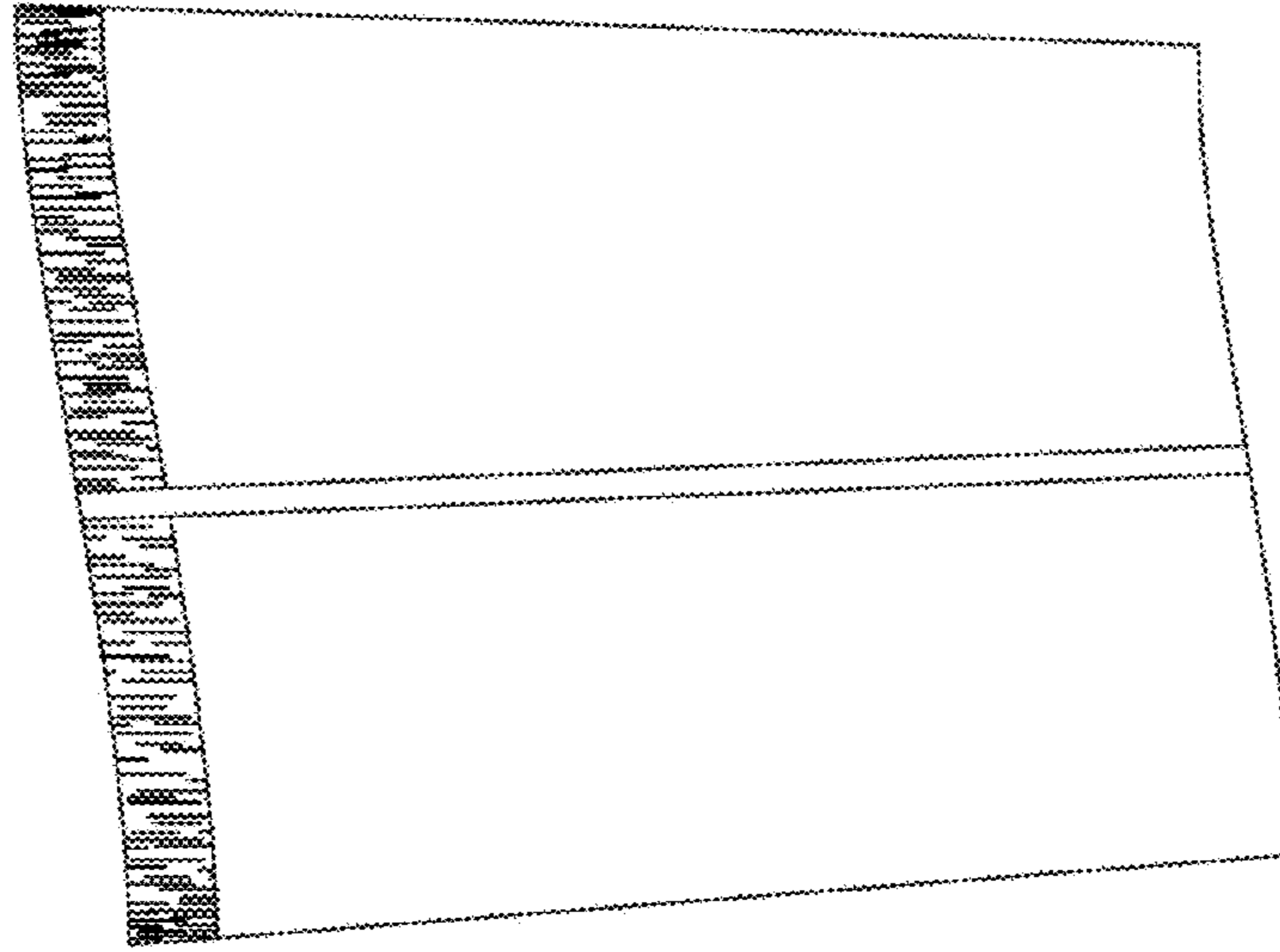

Fig. 6

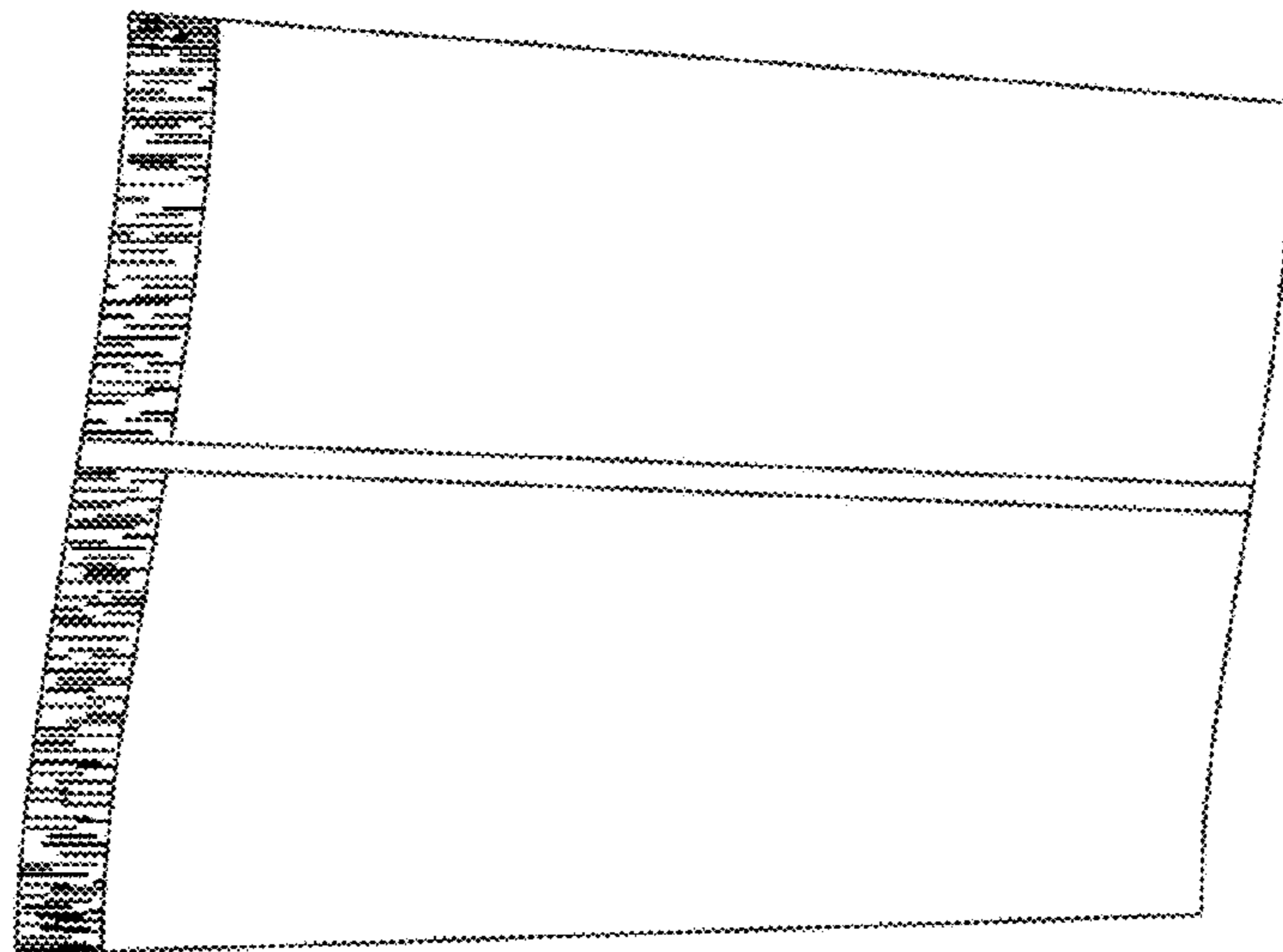

Fig. 7

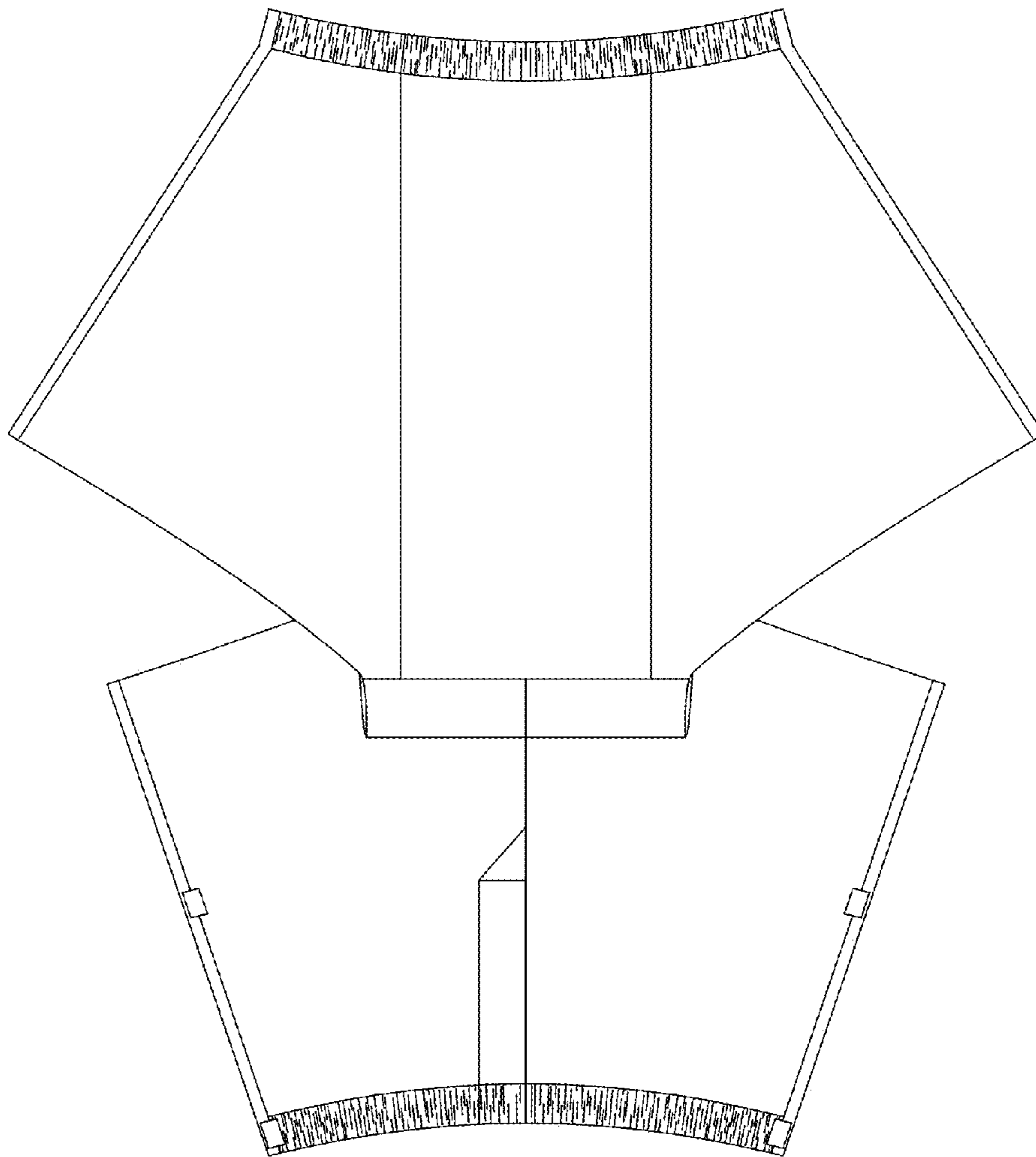

Fig. 8

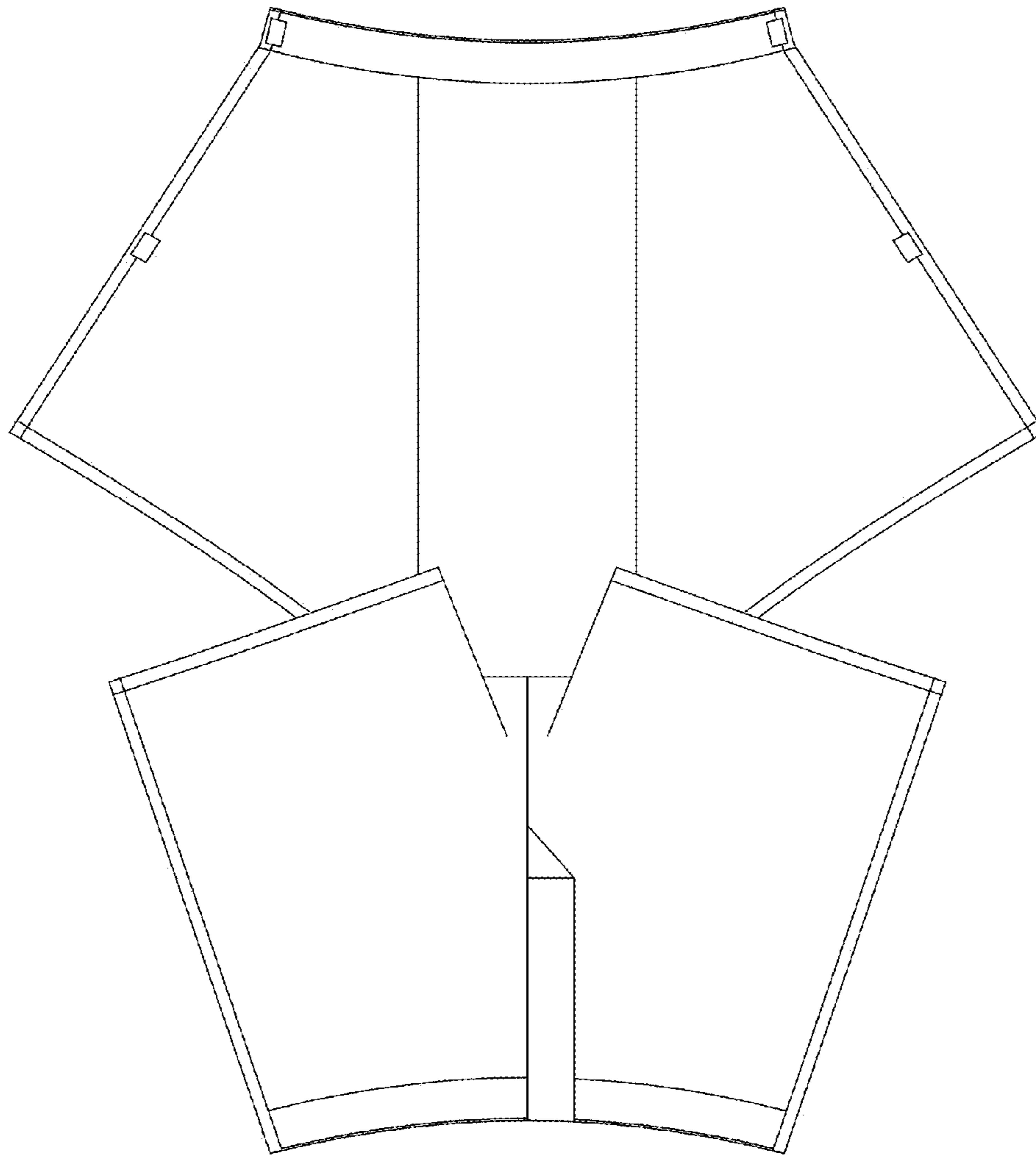

Fig. 9

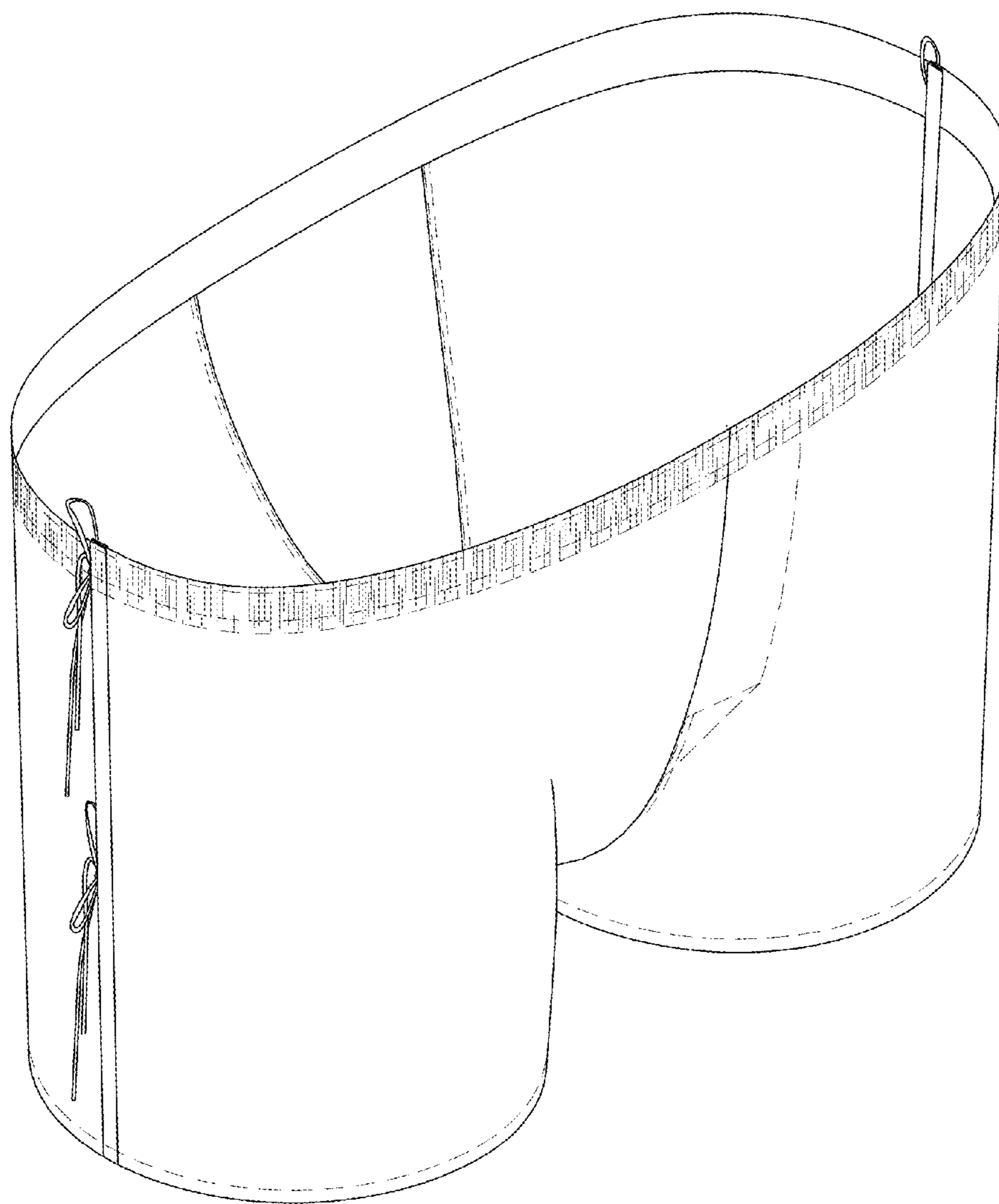

Fig. 10

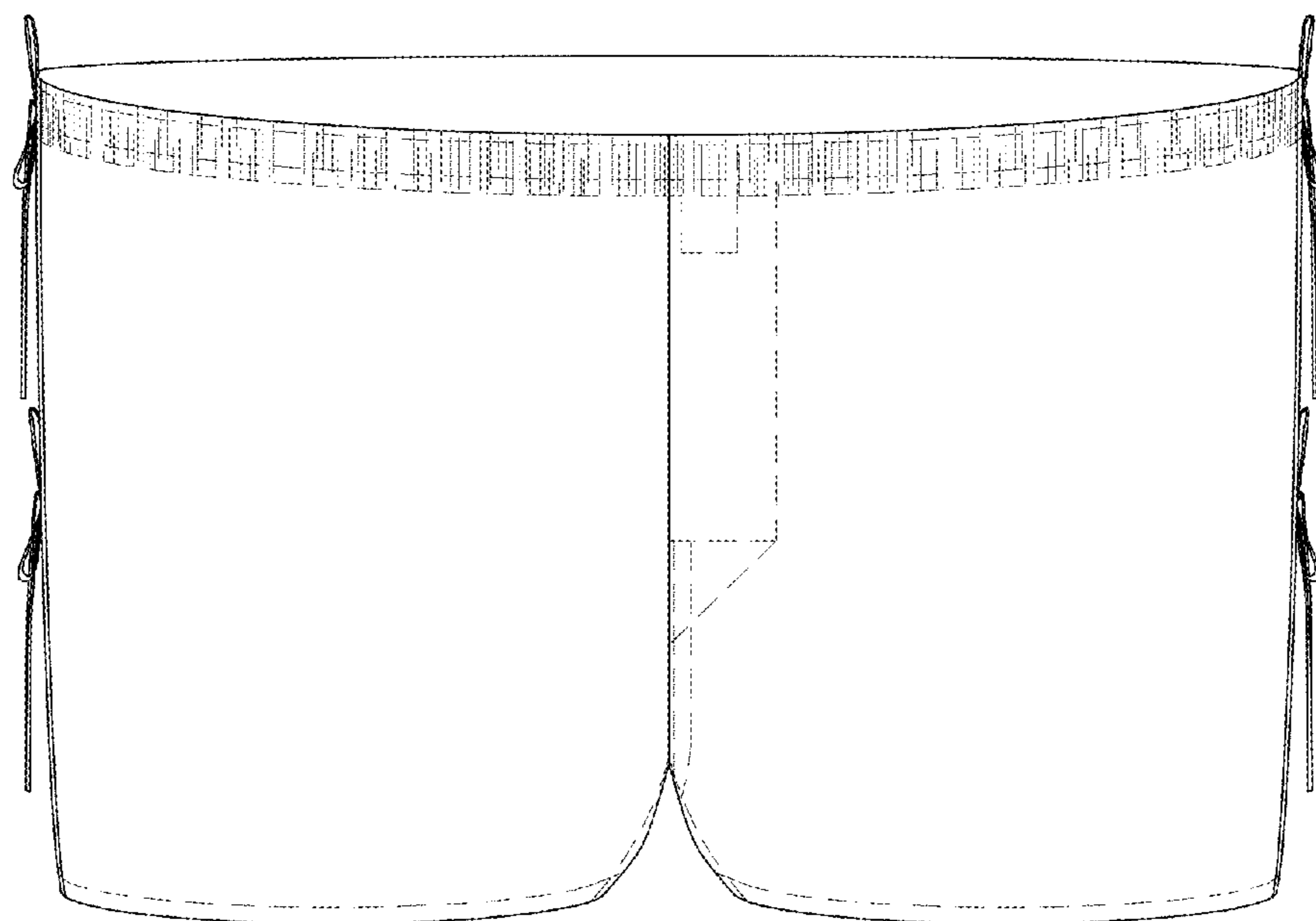

Fig. 11

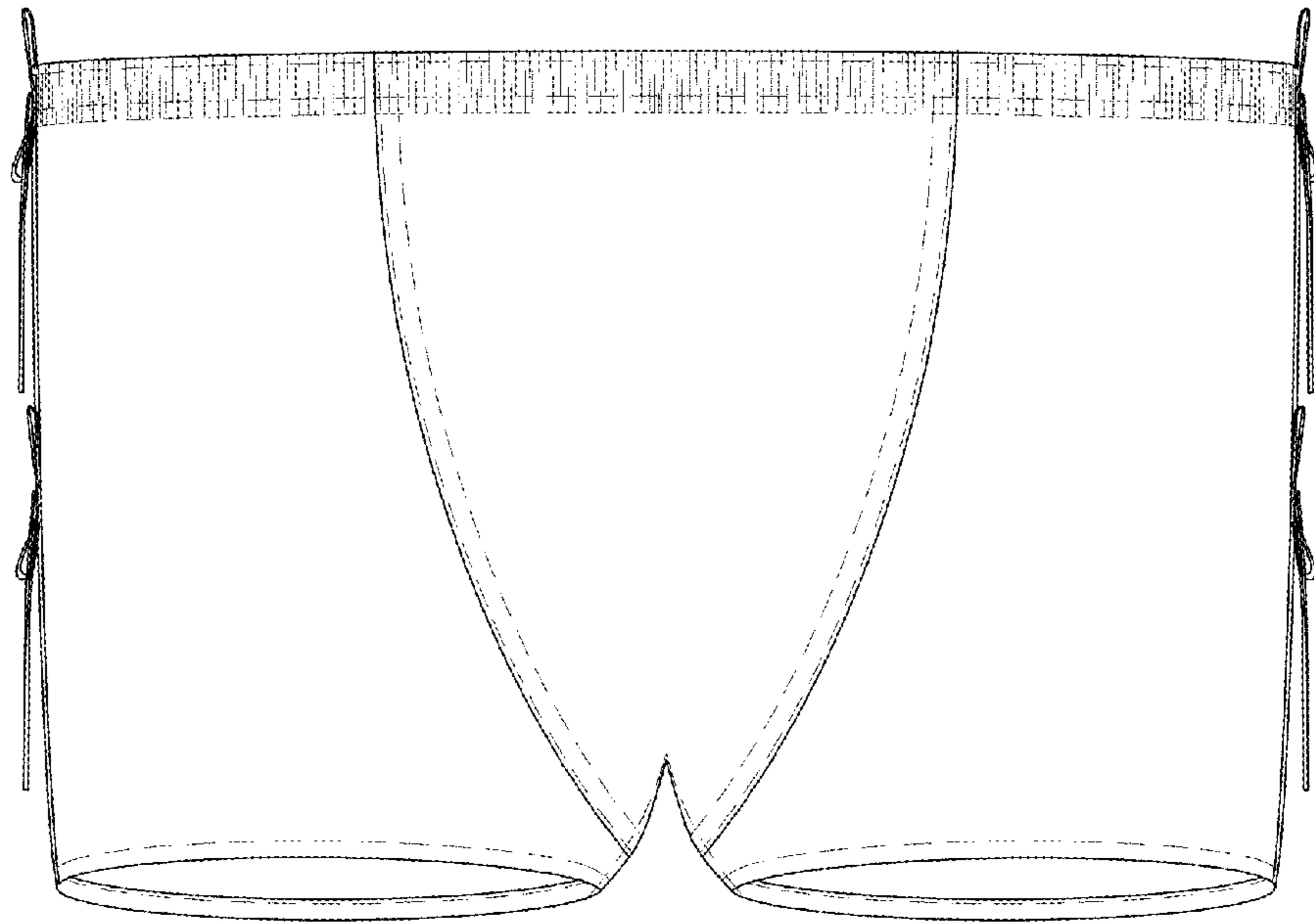

Fig. 12

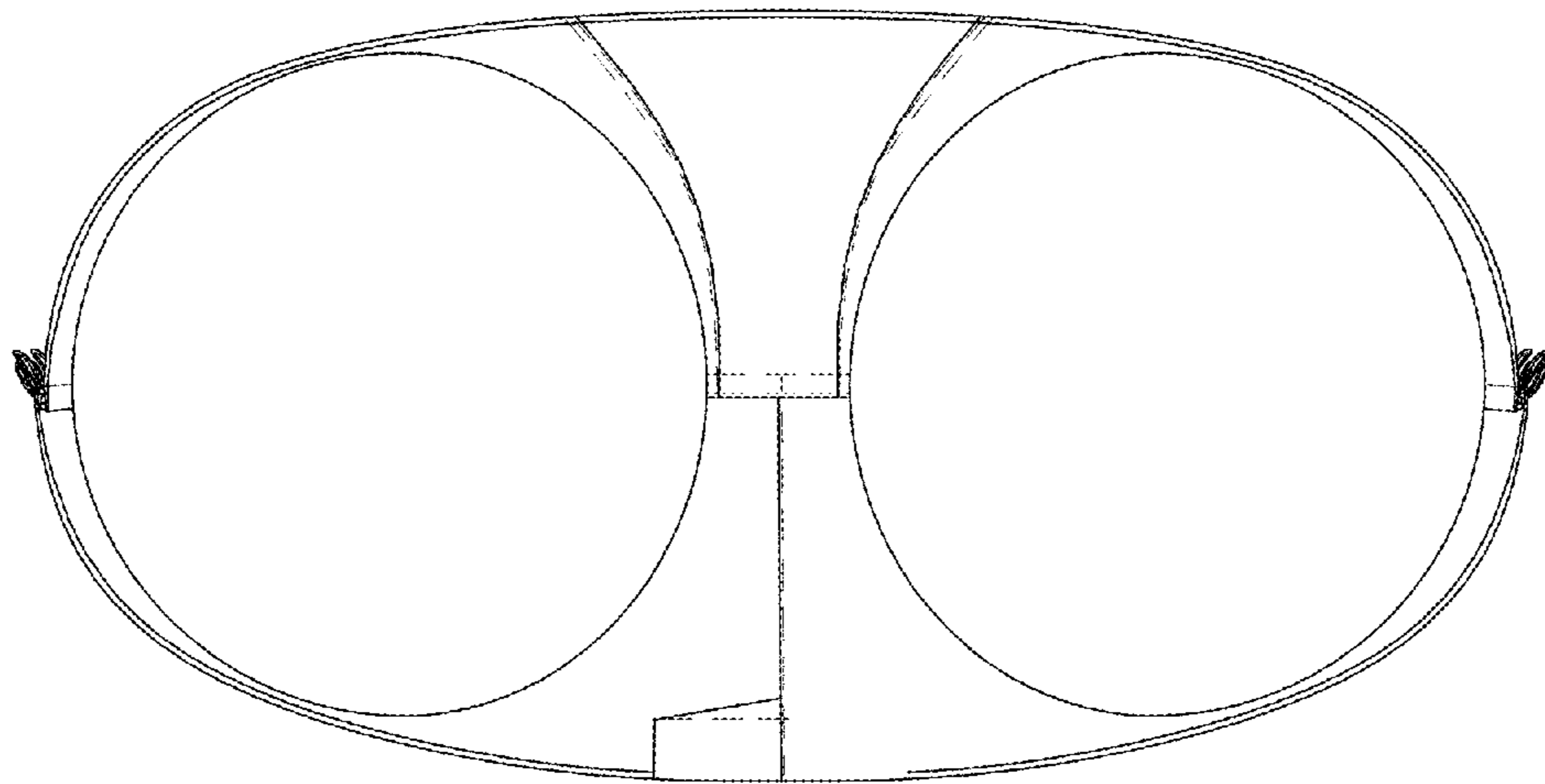

Fig. 13

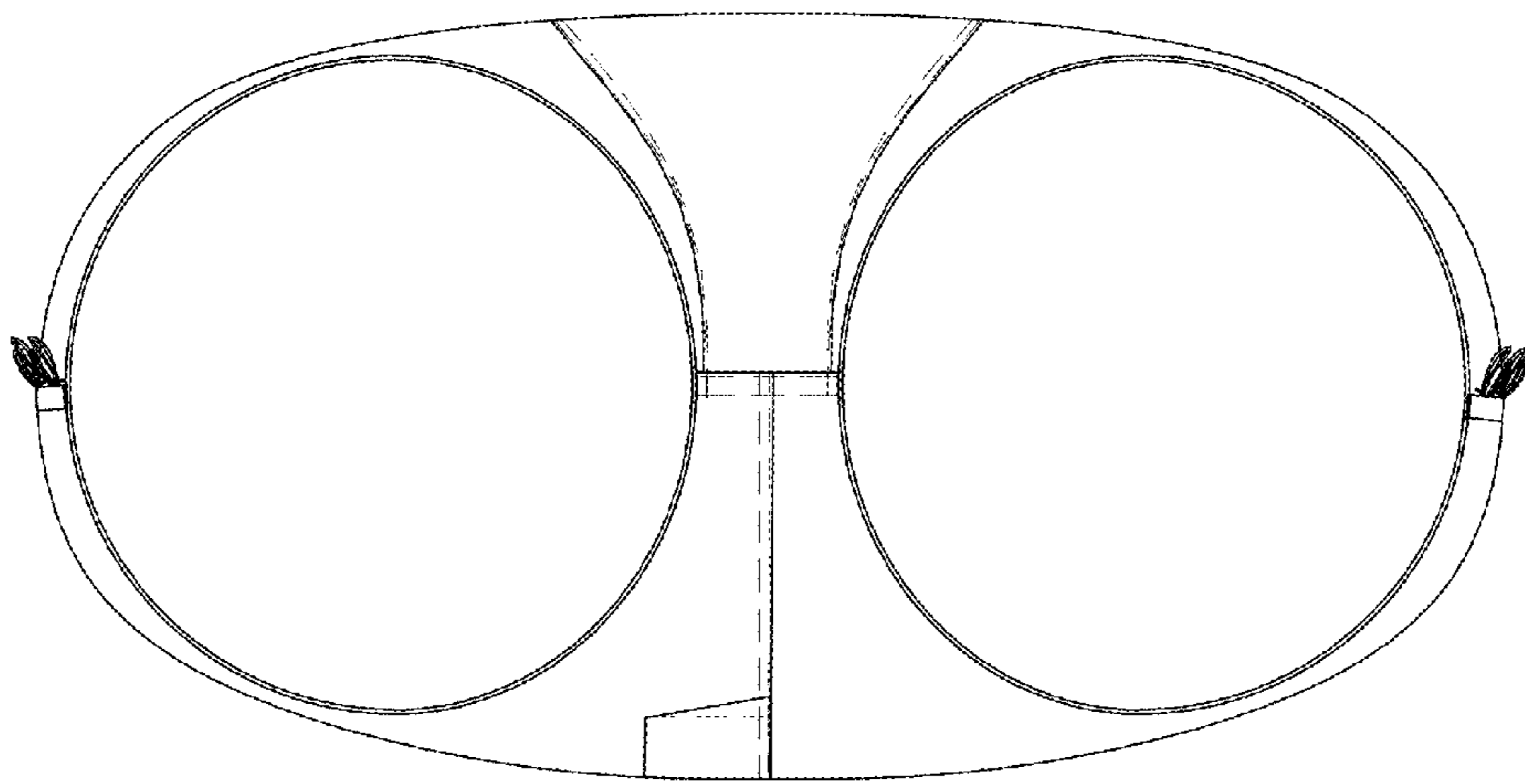

Fig. 14

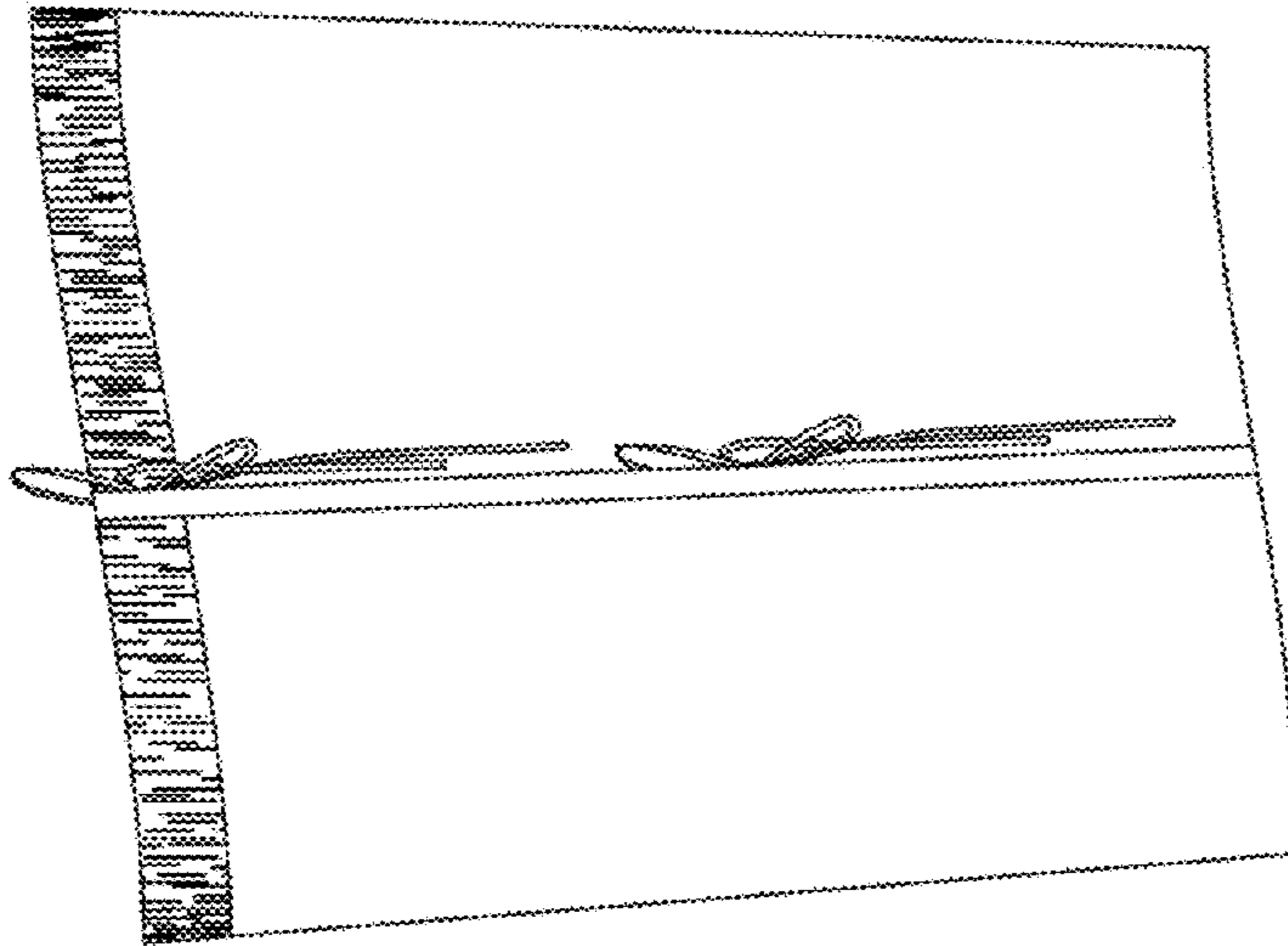

Fig. 15

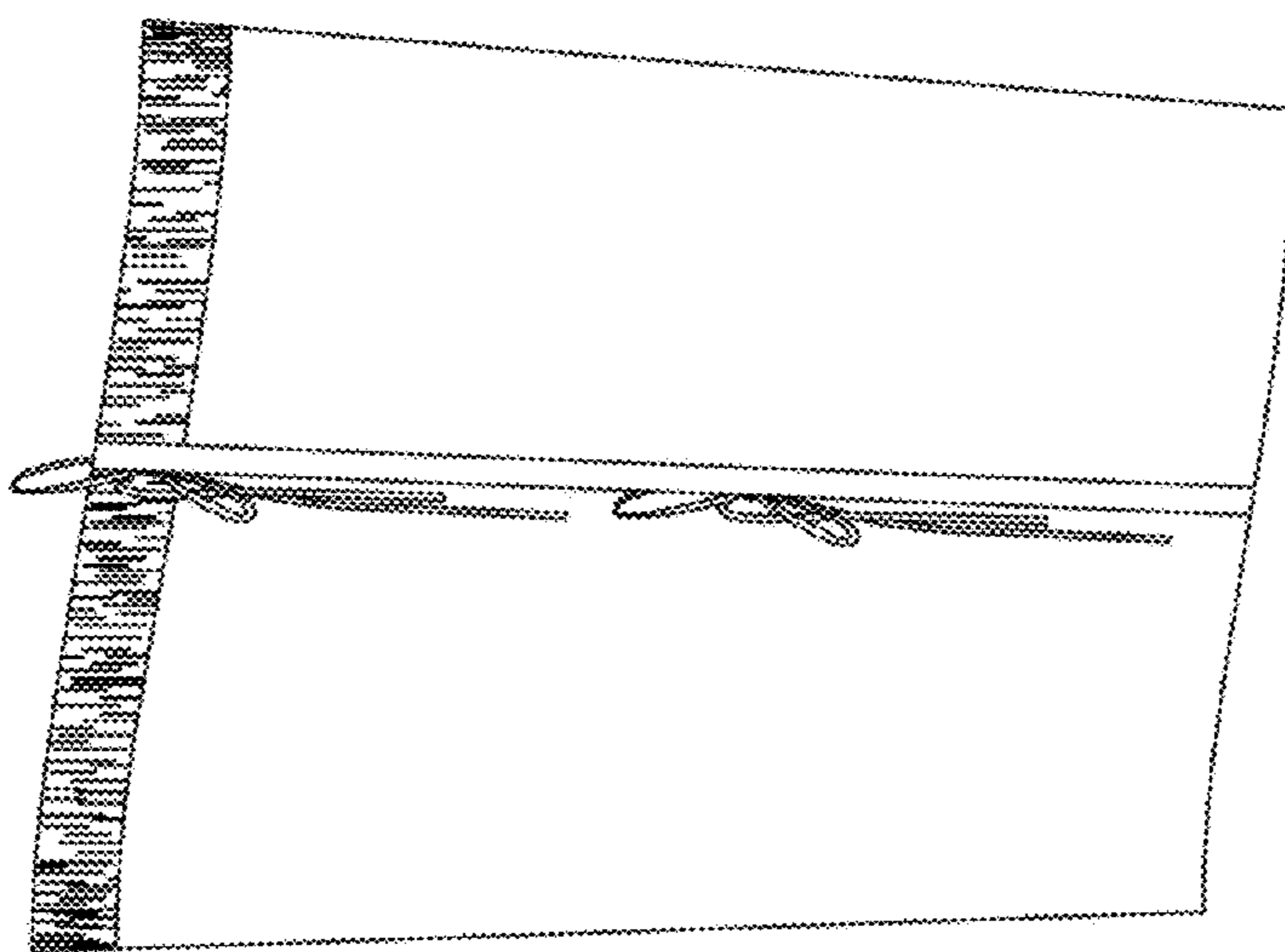

Fig. 16

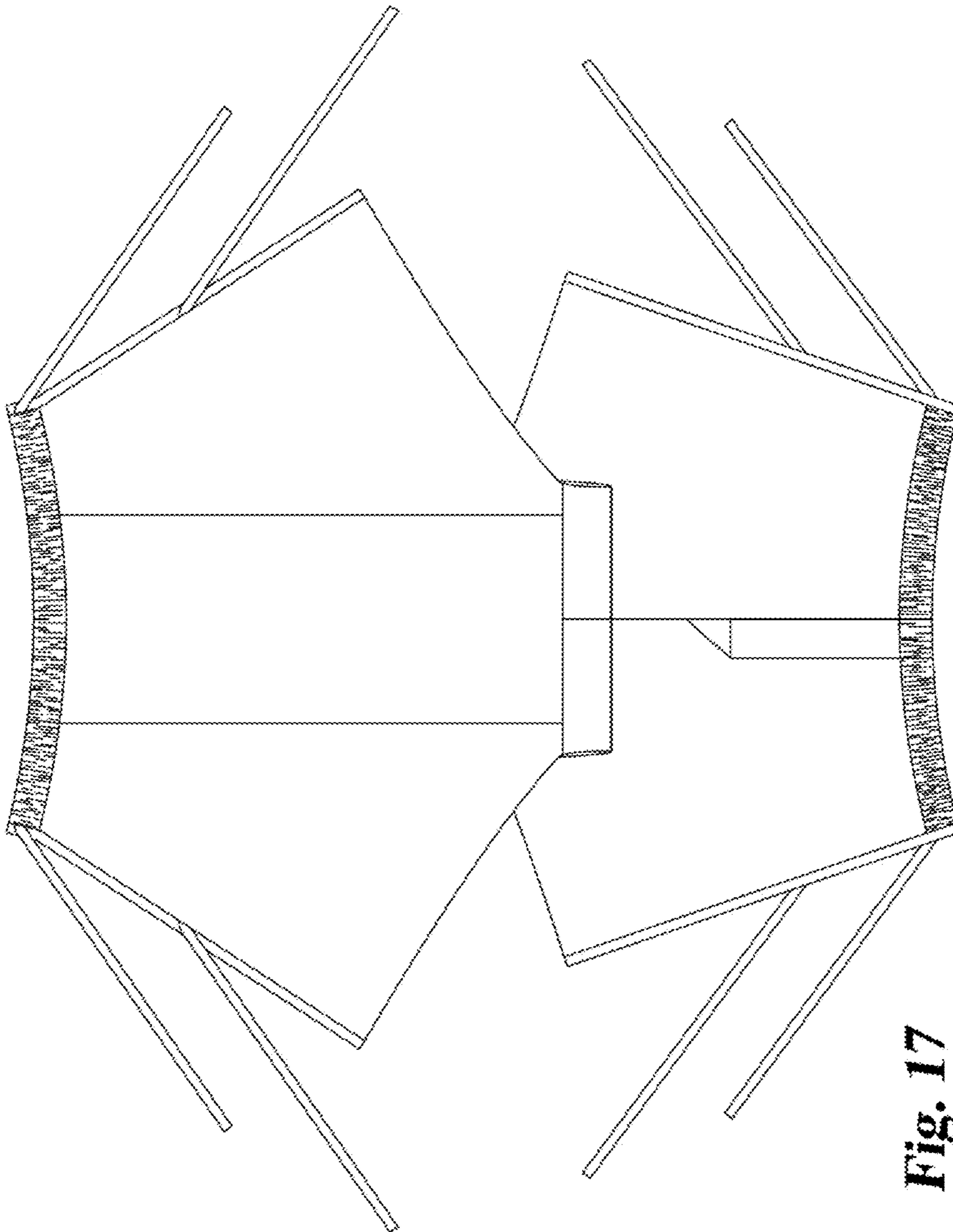

Fig. 17

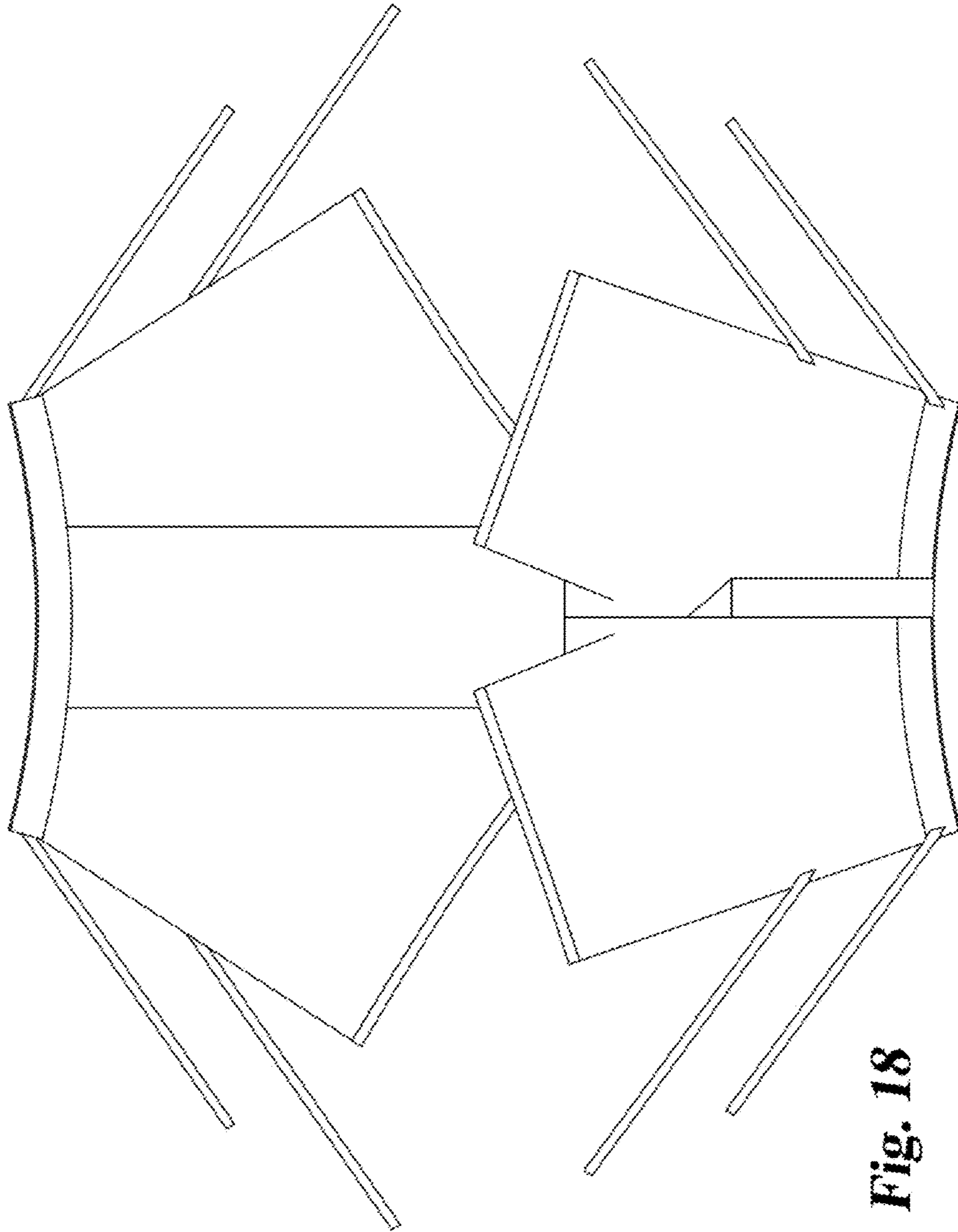

Fig. 18