



US00D704913S

(12) **United States Design Patent**
Choi

(10) **Patent No.:** **US D704,913 S**
(45) **Date of Patent:** **** May 13, 2014**

(54) **IRON**
(71) Applicant: **Lung Wai Choi**, Hong Kong (HK)
(72) Inventor: **Lung Wai Choi**, Hong Kong (HK)
(**) Term: **14 Years**
(21) Appl. No.: **29/468,195**

D487,832 S * 3/2004 Morrison D32/69
D511,232 S * 11/2005 Barquin Santillan et al. . D32/35
D531,370 S * 10/2006 Renault D32/70
D538,991 S * 3/2007 Littmann D32/70
D567,461 S * 4/2008 Poon D32/69
D590,563 S * 4/2009 Lin et al. D32/69
D594,617 S * 6/2009 Yeung D32/69
D595,019 S * 6/2009 Poon D32/69
D599,070 S * 8/2009 Hosoda et al. D32/68
D623,816 S * 9/2010 Pardo et al. D32/70

* cited by examiner

(22) Filed: **Sep. 27, 2013**
(51) **LOC (10) Cl.** **07-05**
(52) **U.S. Cl.**
USPC **D32/70**
(58) **Field of Classification Search**
USPC D32/73, 72, 71, 70, 69, 68, 35;
392/404; 38/97, 96, 93, 88, 77.9,
38/77.83, 77.82, 77.81, 77.8, 77.7, 77.6,
38/77.5, 77.3, 77.1; 219/251, 245
See application file for complete search history.

Primary Examiner — Austin Murphy

(57) **CLAIM**
The ornamental design for an iron, as shown and described.

(56) **References Cited**
U.S. PATENT DOCUMENTS
D212,700 S * 11/1968 Teleki D21/526
D371,878 S * 7/1996 Muller D32/69
D415,865 S * 10/1999 Littmann et al. D32/70
6,396,027 B1 * 5/2002 Wu 219/248
D466,260 S * 11/2002 Wu D32/69

DESCRIPTION

FIG. 1 is a front elevation view of an iron showing my new design;
FIG. 2 is a right side view thereof;
FIG. 3 is a rear elevation thereof;
FIG. 4 is a left side view thereof;
FIG. 5 is a top view thereof.
FIG. 6 is a bottom view thereof; and,
FIG. 7 is a perspective view thereof.

1 Claim, 7 Drawing Sheets

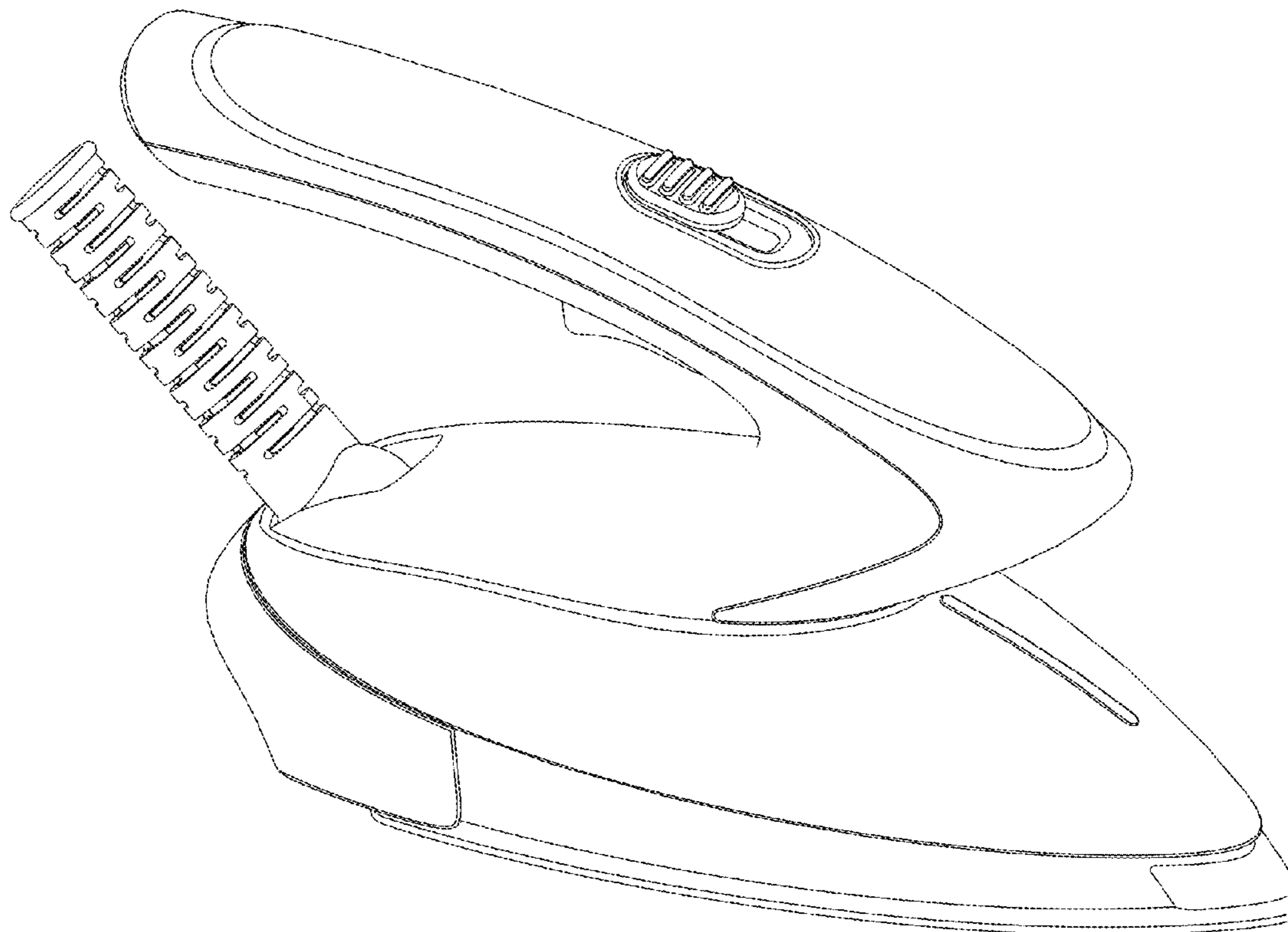

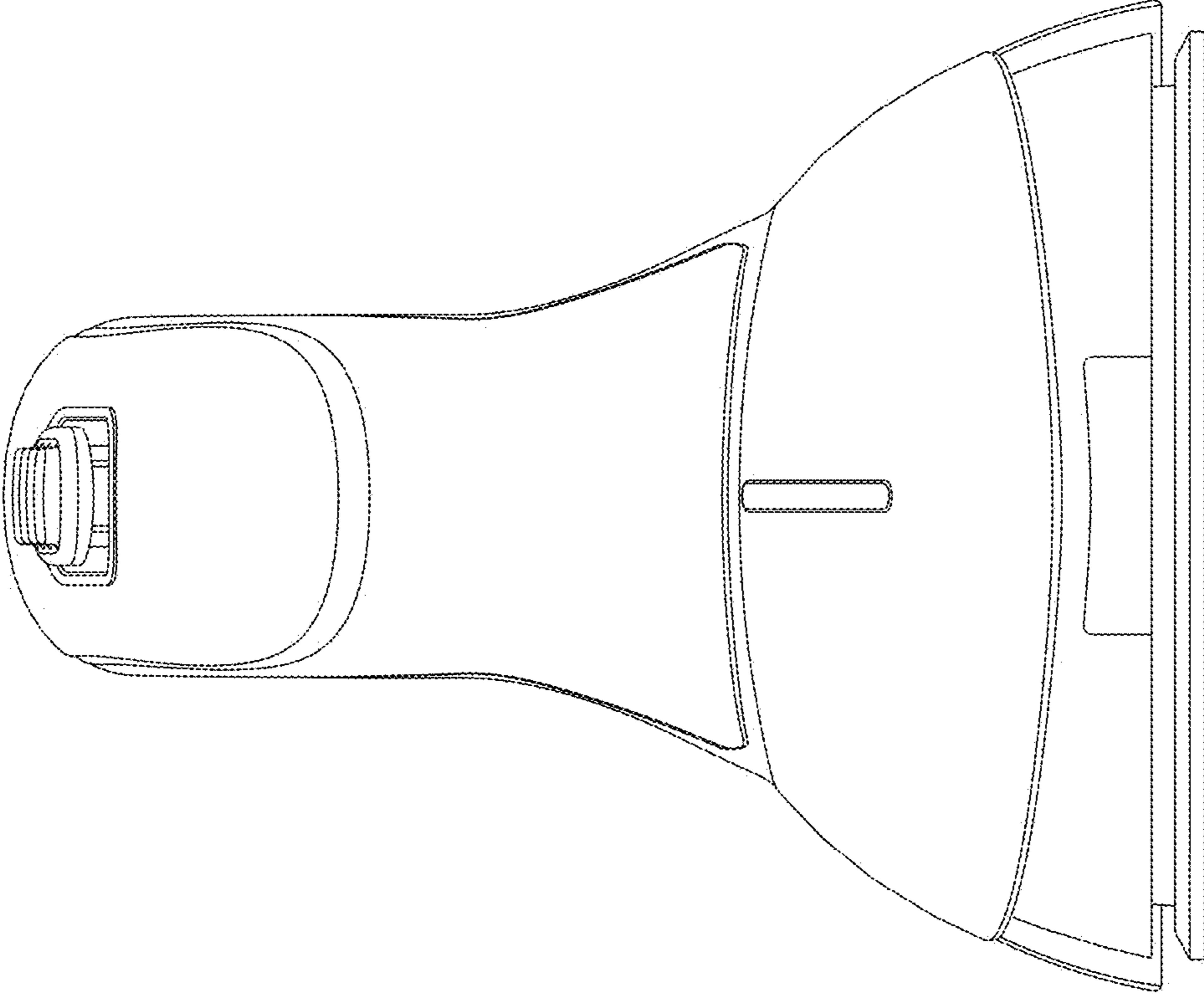

FIG. 1



FIG. 2

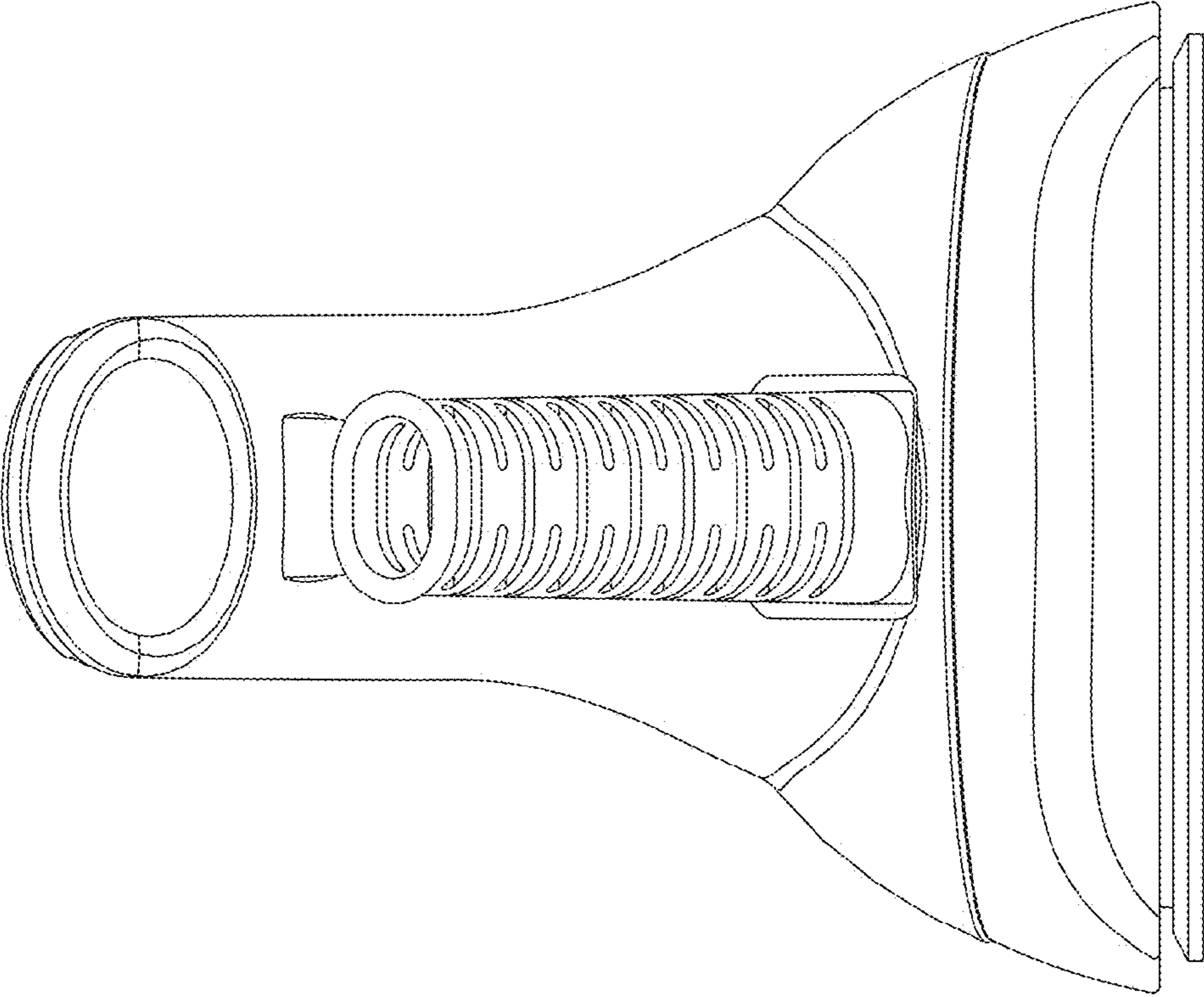

FIG. 3

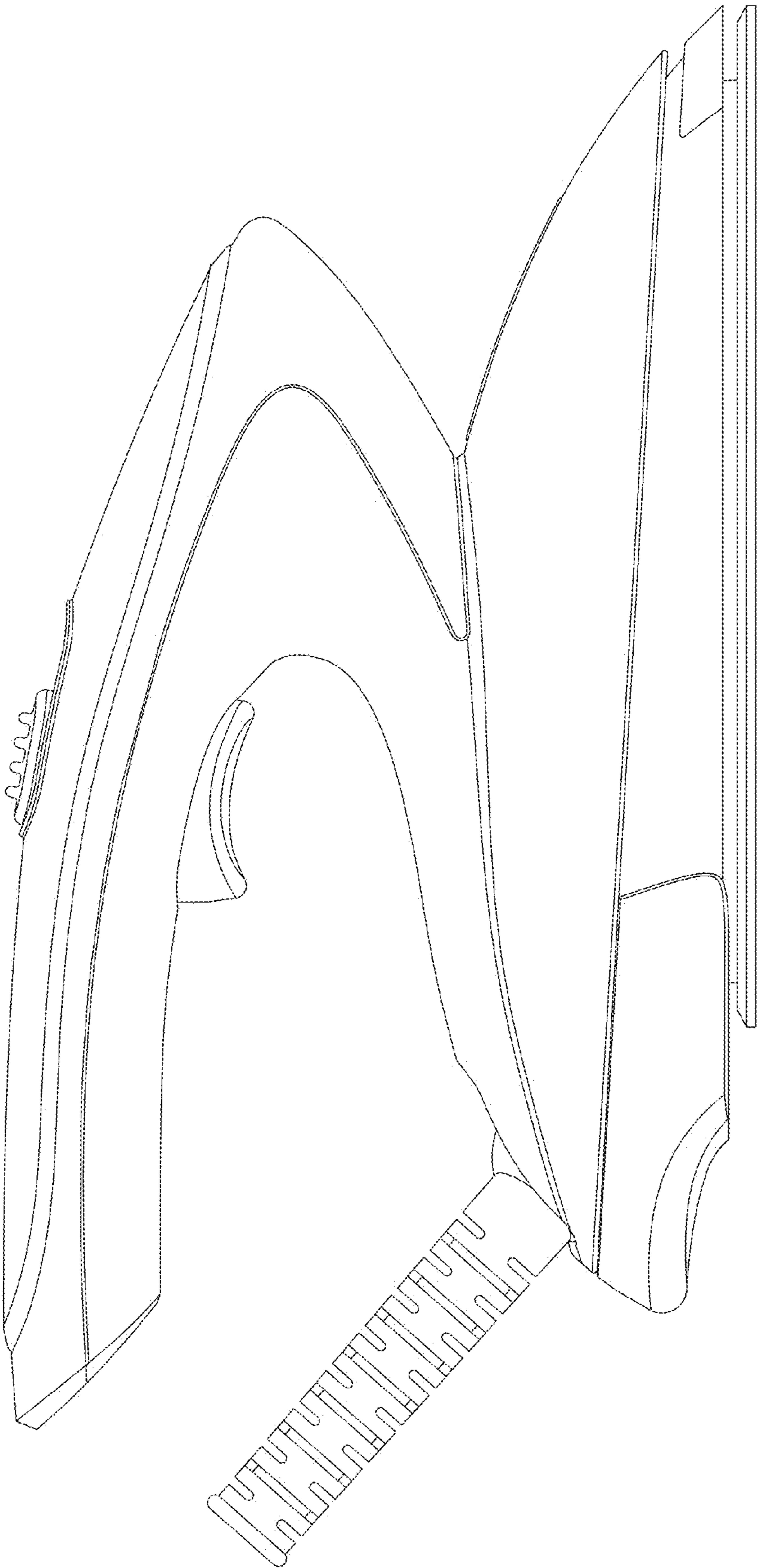

FIG. 4

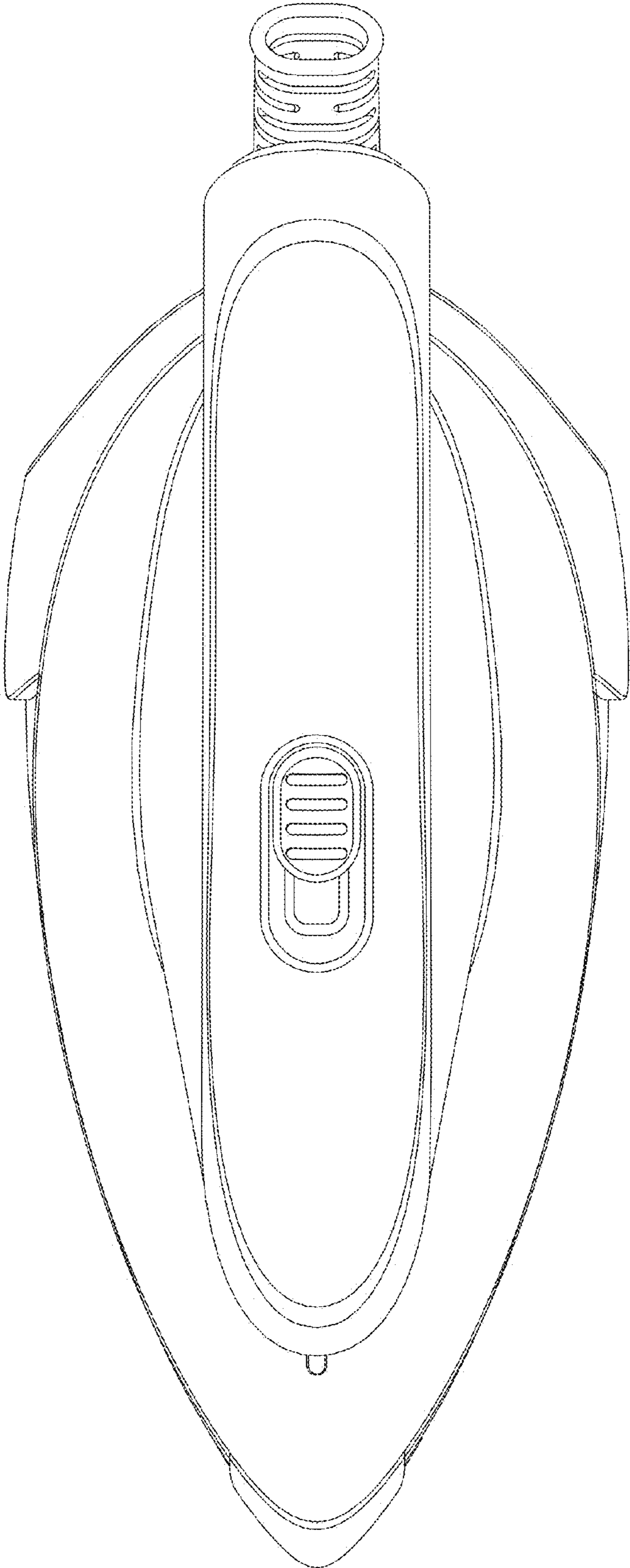

FIG. 5

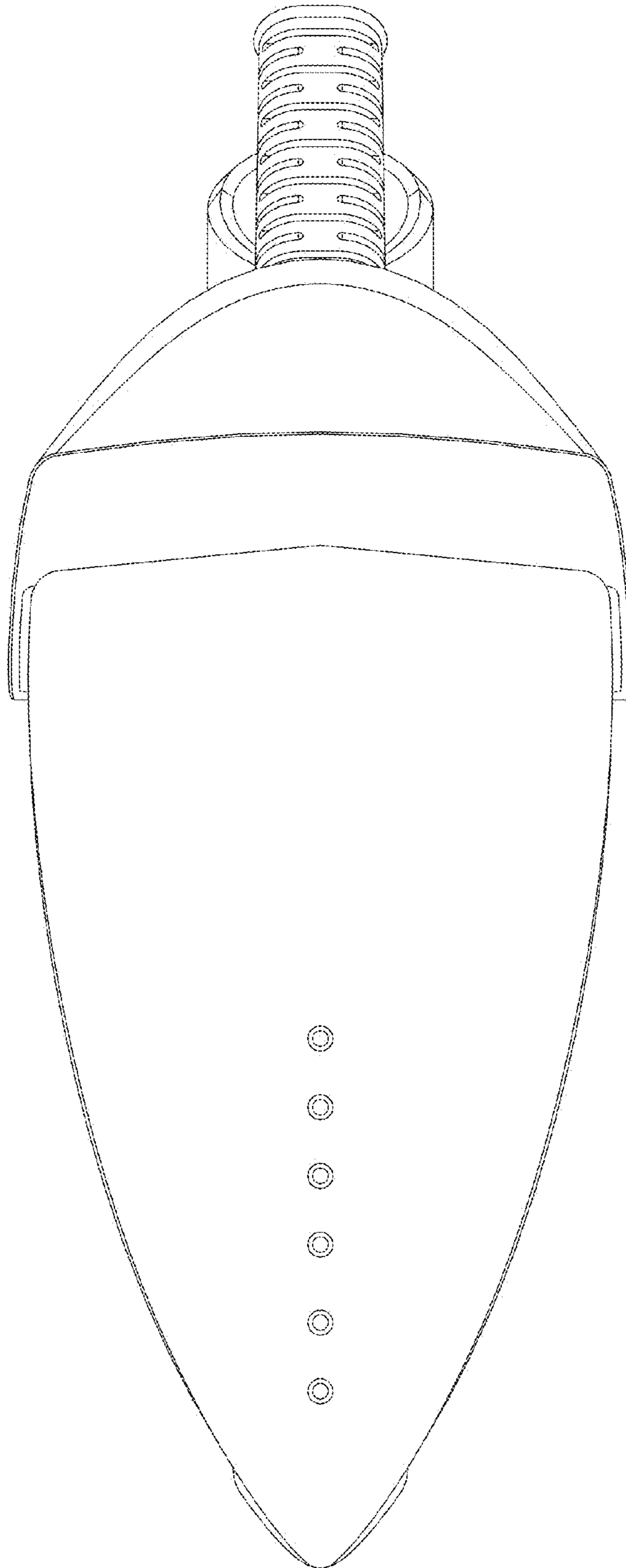

FIG. 6

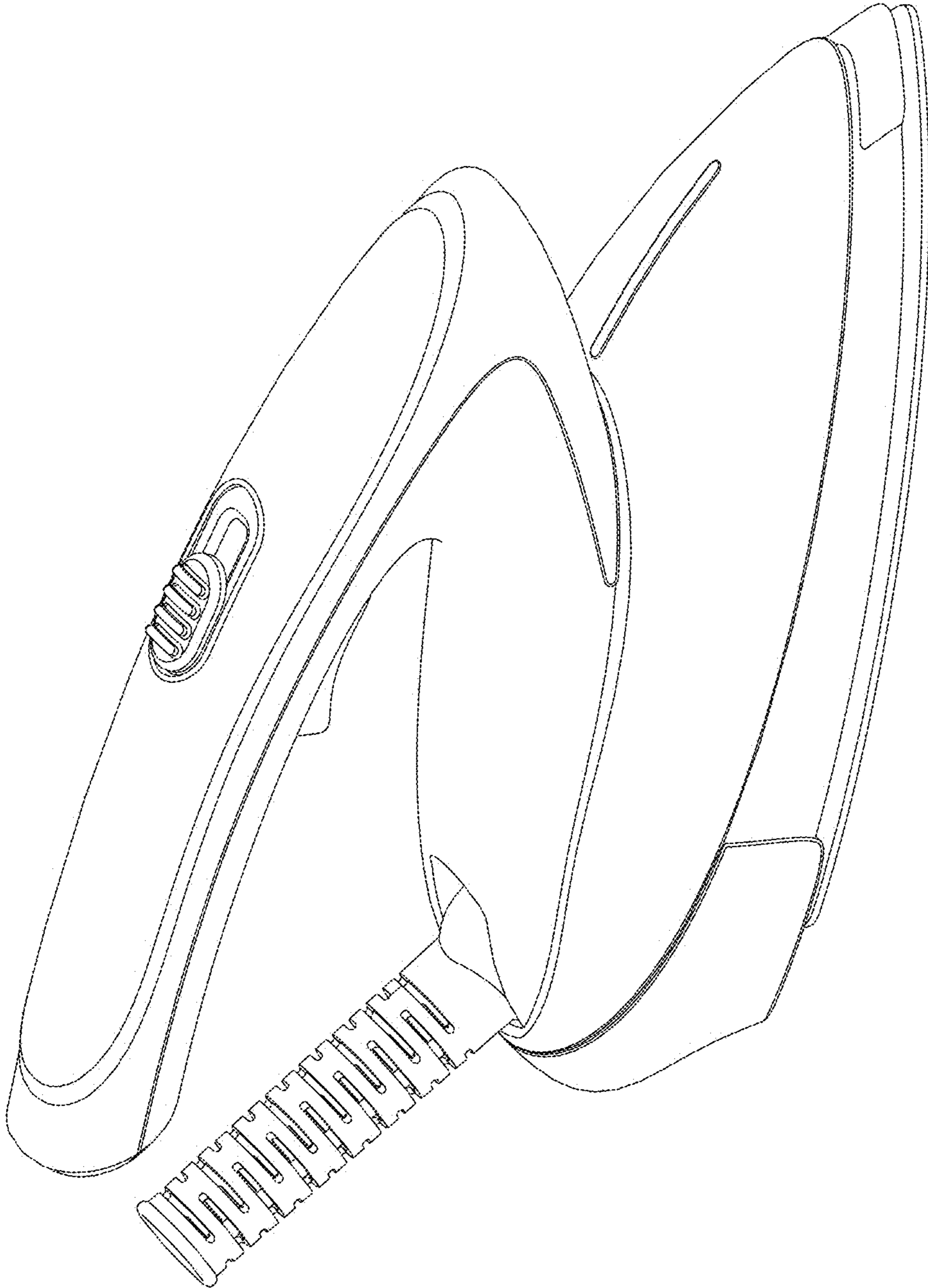

FIG. 7