



US00D704889S

(12) **United States Design Patent**  
**Chiu**

(10) **Patent No.:** **US D704,889 S**

(45) **Date of Patent:** **\*\* May 13, 2014**

(54) **NAIL UV LIGHT**

(71) Applicant: **Shu-Lin Yeh**, Taichung (TW)

(72) Inventor: **Mei-Chun Chiu**, Taichung (TW)

(73) Assignee: **Shu-Lin Yeh**, Taichung (TW)

(\*\*) Term: **14 Years**

(21) Appl. No.: **29/459,488**

(22) Filed: **Jul. 1, 2013**

(51) **LOC (10) Cl.** ..... **28-03**

(52) **U.S. Cl.**  
USPC ..... **D28/58**; D28/54.1

(58) **Field of Classification Search**  
USPC ..... D28/54.1, 56-58; 250/504 R-504 H,  
250/492.1, 202; 132/73; D24/209-210;  
34/275, 202, 90  
See application file for complete search history.

(56) **References Cited**

**U.S. PATENT DOCUMENTS**

D277,323	S	*	1/1985	Raicevic	.....	D28/58
D299,559	S	*	1/1989	Wong	.....	D28/58
D453,858	S	*	2/2002	Tsai	.....	D28/58
8,450,705	B1	*	5/2013	Chen et al.	.....	250/492.1
D686,369	S	*	7/2013	Horvath et al.	.....	D28/58
2006/0260628	A1	*	11/2006	Chan	.....	132/73

\* cited by examiner

*Primary Examiner* — Jennifer Rivard

(74) *Attorney, Agent, or Firm* — Leong C. Lei

(57) **CLAIM**

The ornamental design for a nail UV light, as shown and described.

**DESCRIPTION**

FIG. 1 is a front perspective view of a nail UV light showing my new design;  
FIG. 2 is a front elevational view thereof;  
FIG. 3 is a rear elevational view thereof;  
FIG. 4 is a left elevational view thereof;  
FIG. 5 is a right elevational view thereof;  
FIG. 6 is a top plan view thereof;  
FIG. 7 is a bottom plan view thereof;  
FIG. 8 is another bottom perspective view thereof;  
FIG. 9 is another perspective view thereof, with the bottom portion being detached from the nail UV light;  
FIG. 10 is another bottom perspective view thereof, with the bottom portion being detached from the nail UV light; and,  
FIG. 11 is another perspective view thereof, showing the status while in use, with the user's hand being engaged.  
The broken lines illustrate the environment of the nail UV light and form no part of the claimed design.

**1 Claim, 11 Drawing Sheets**

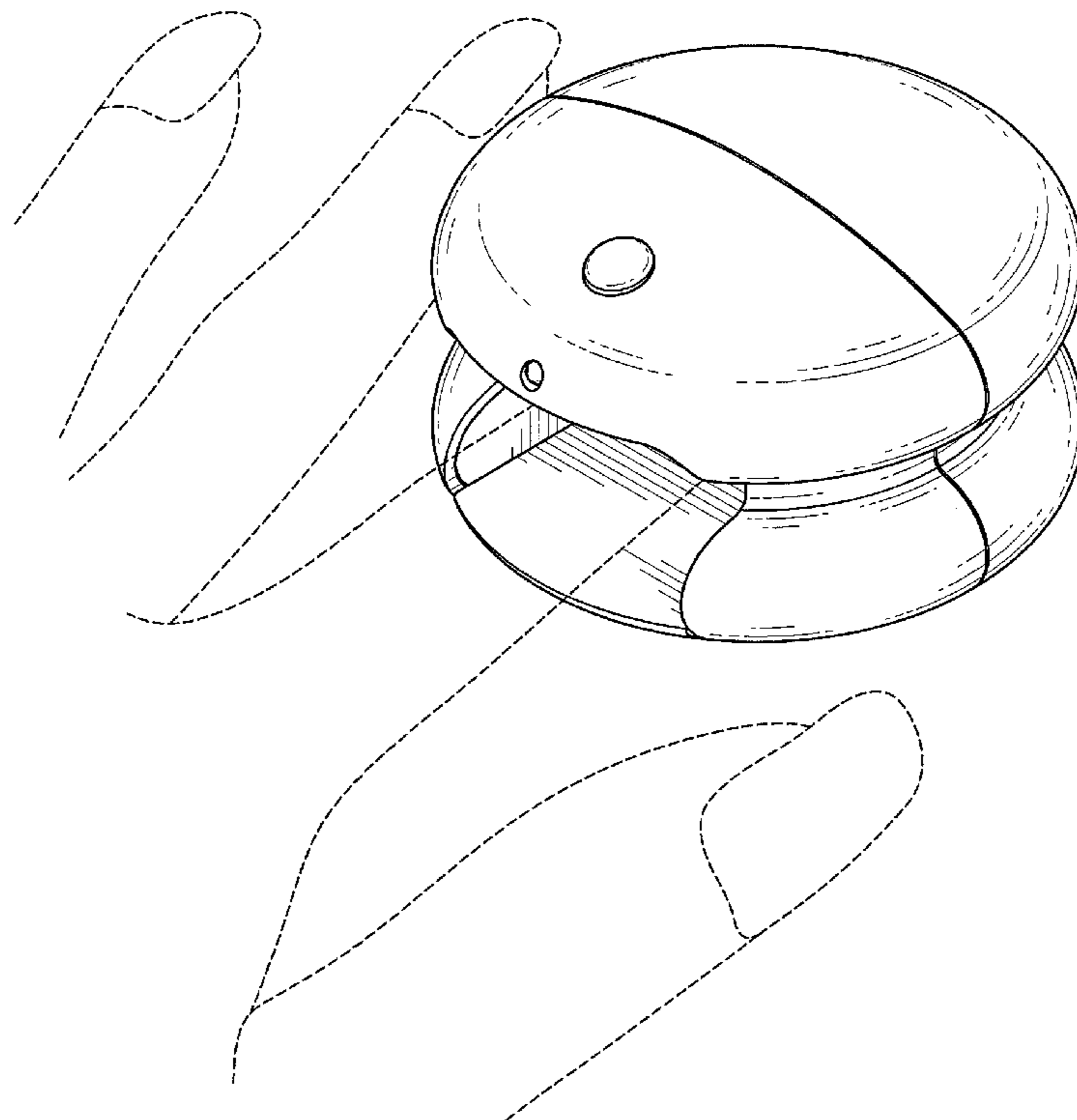

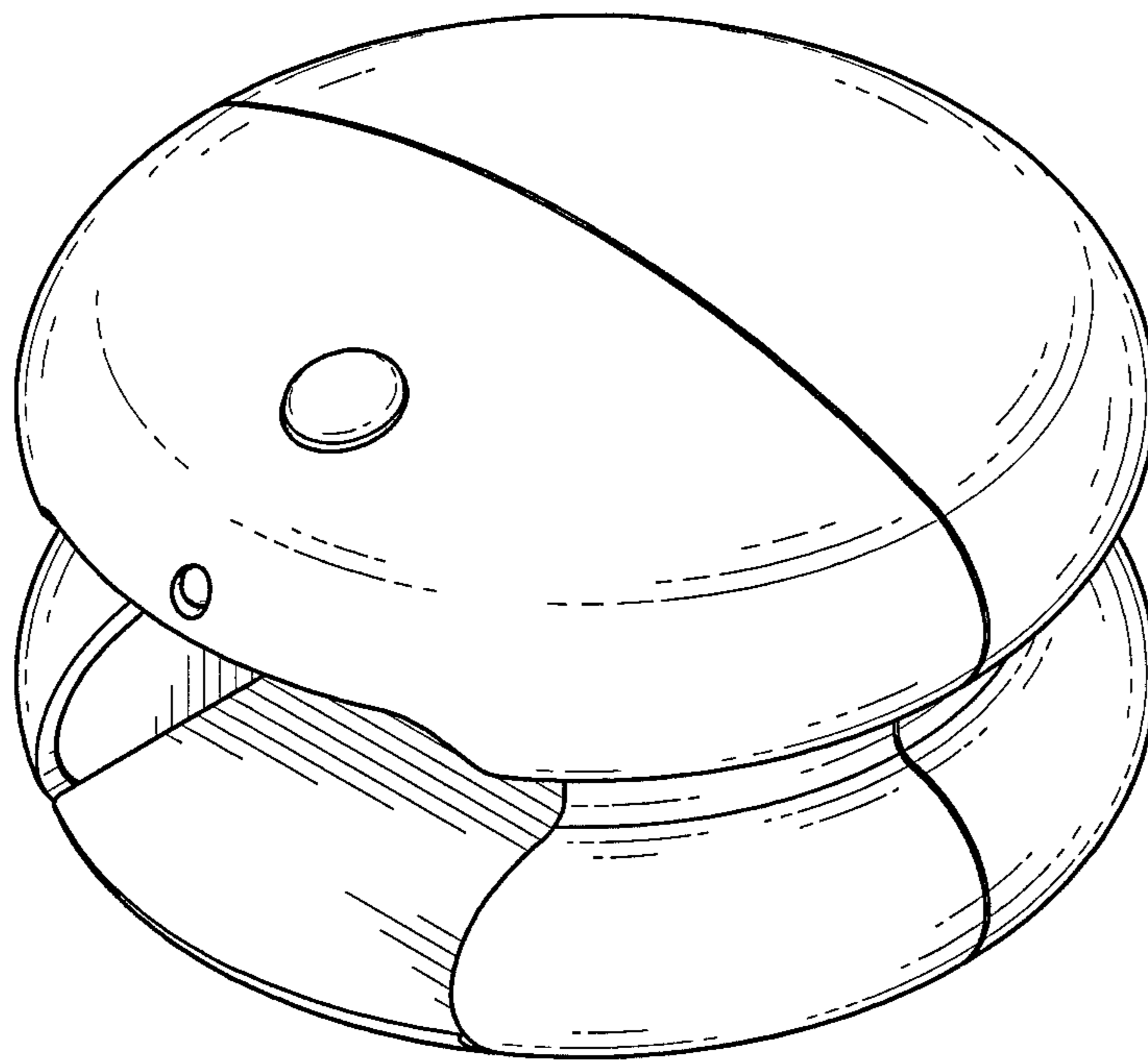
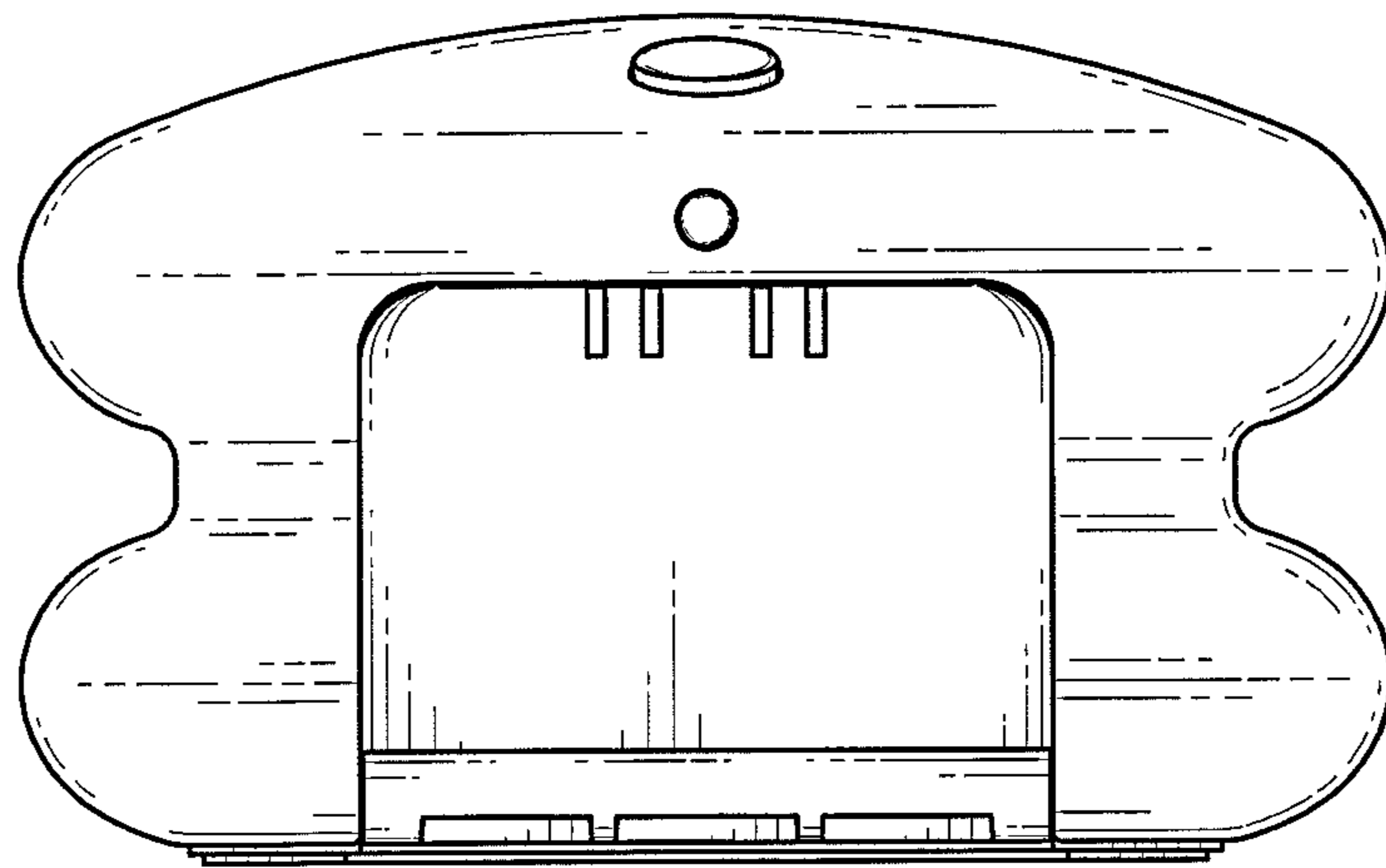
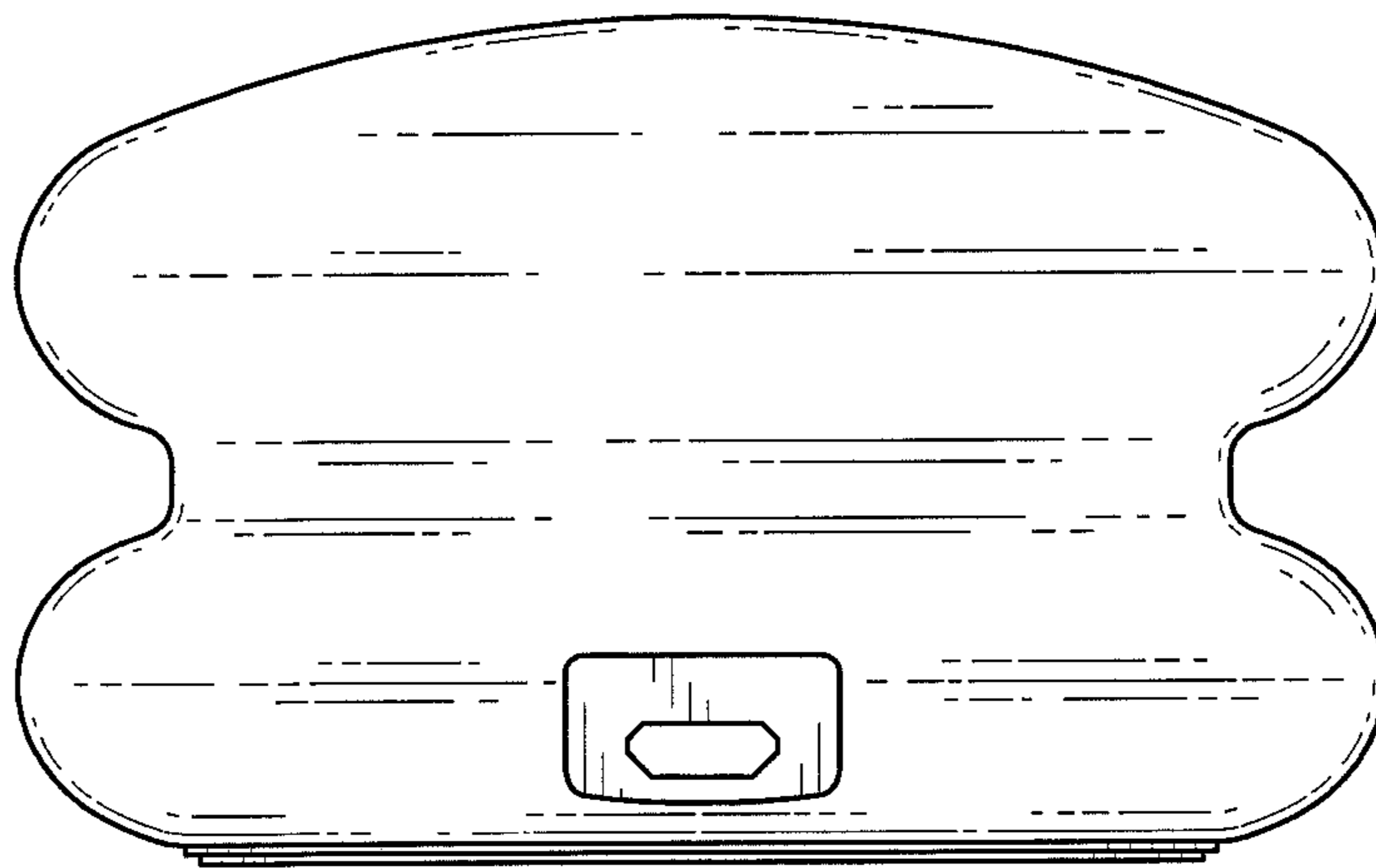

FIG. 1



*FIG. 2*



*FIG. 3*

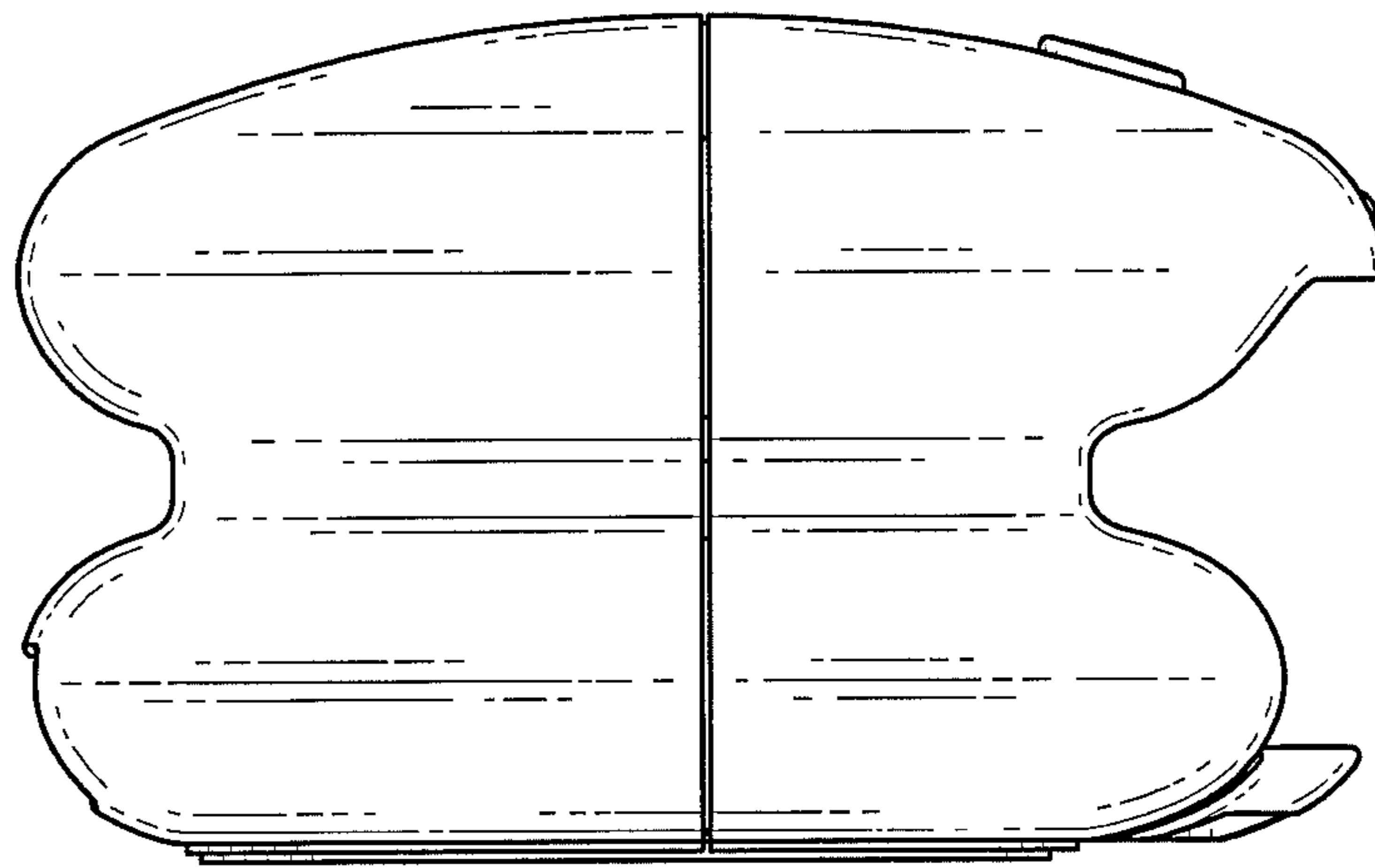

*FIG. 4*

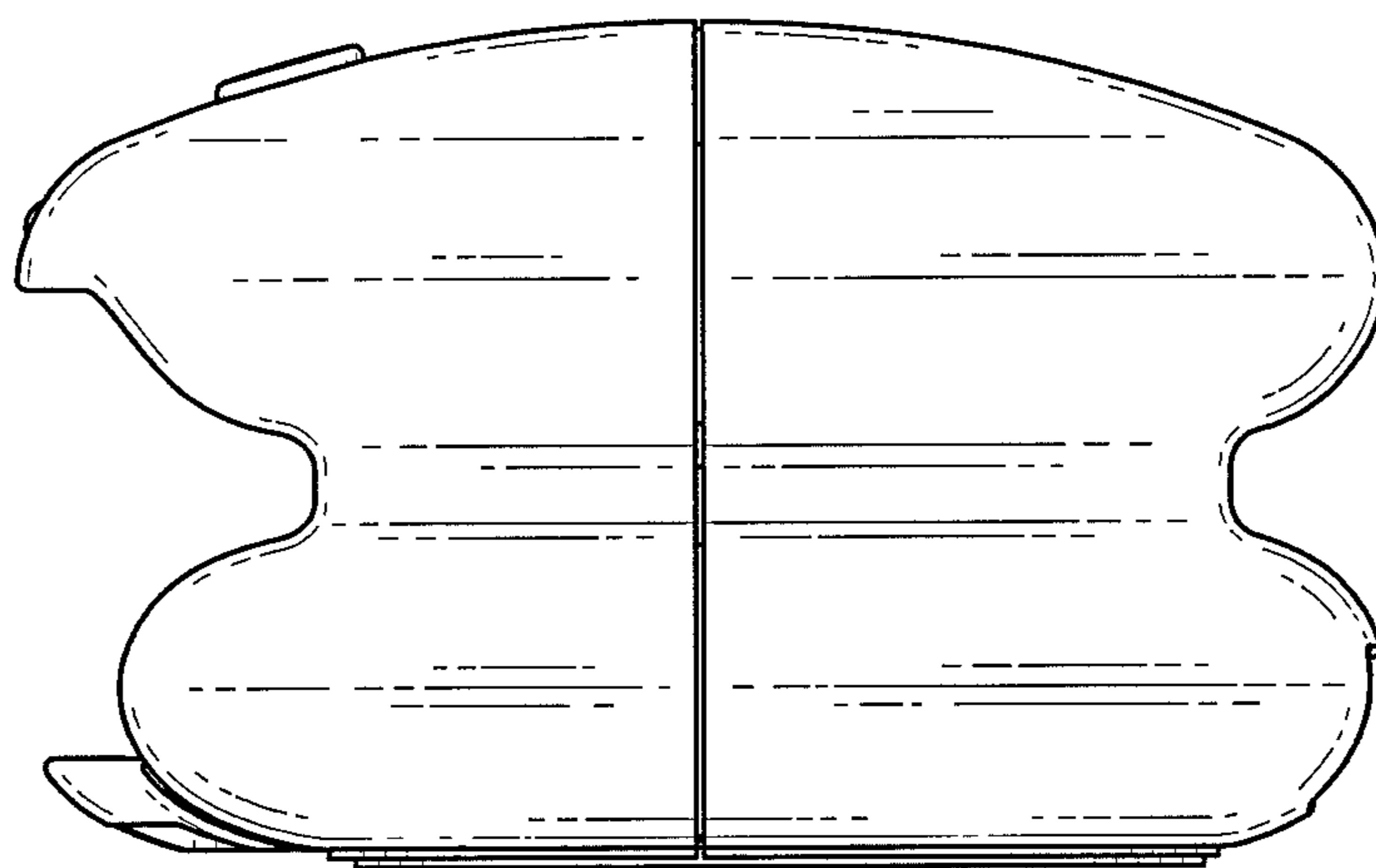

FIG. 5

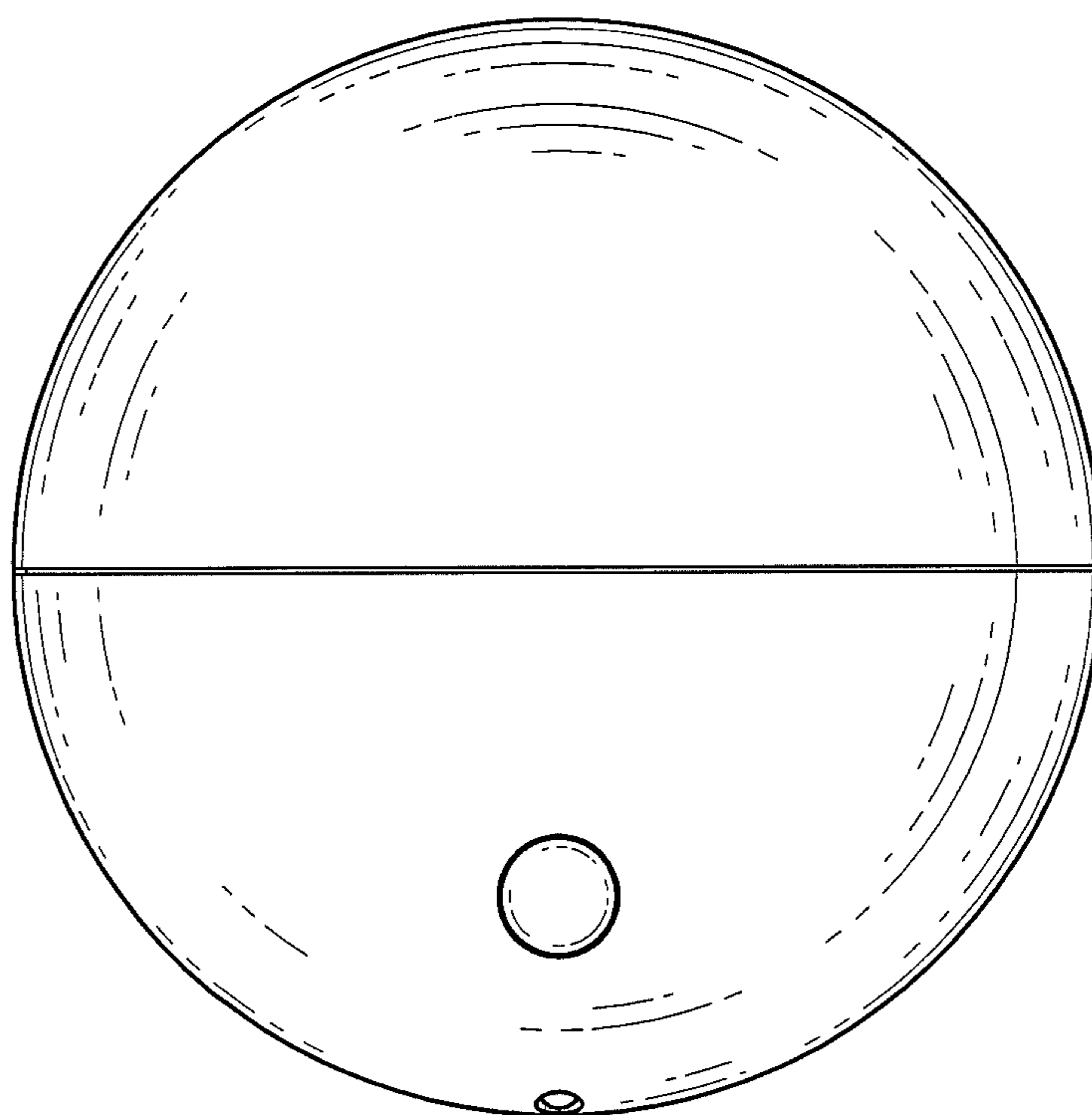

FIG. 6

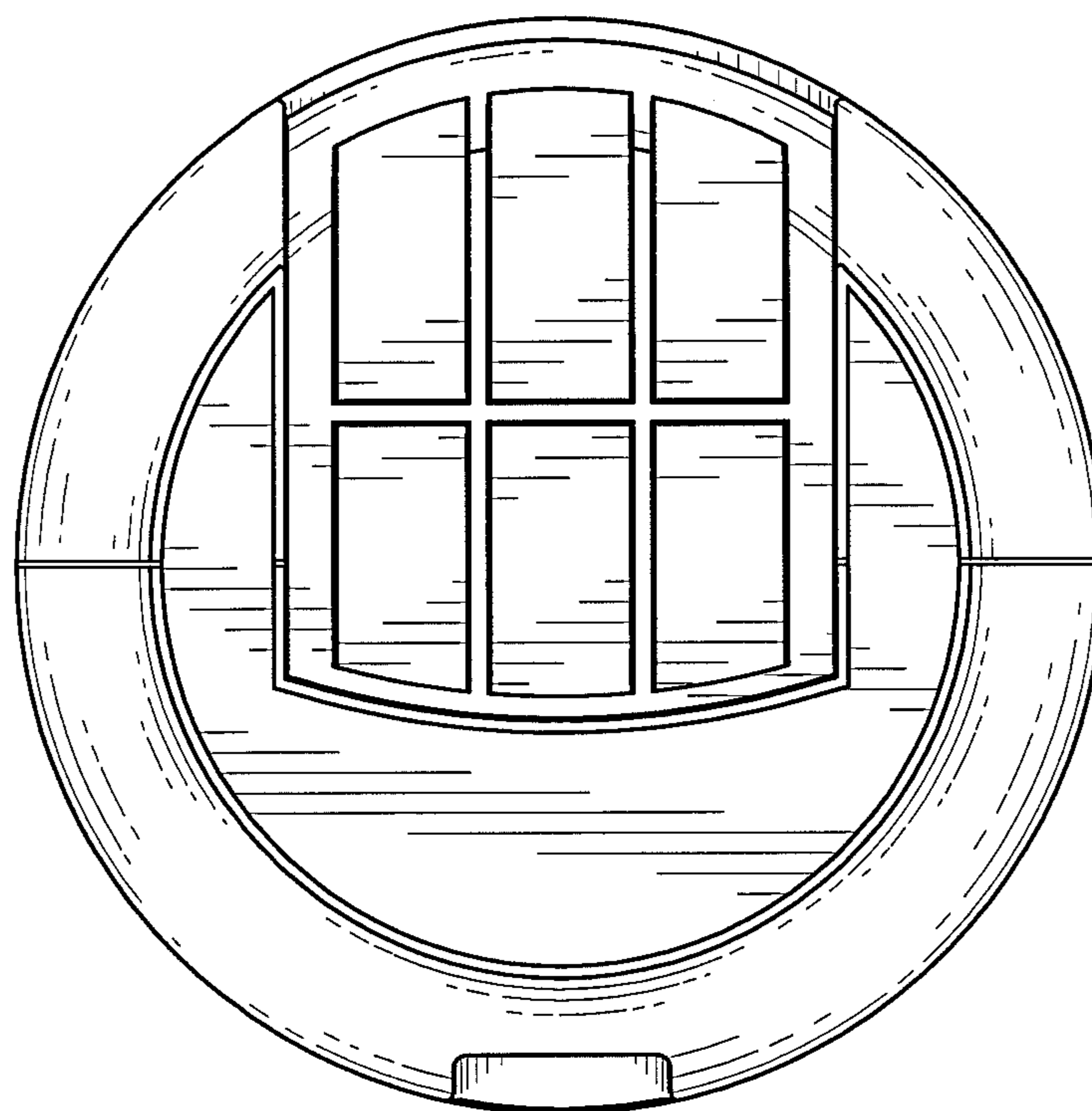

FIG. 7



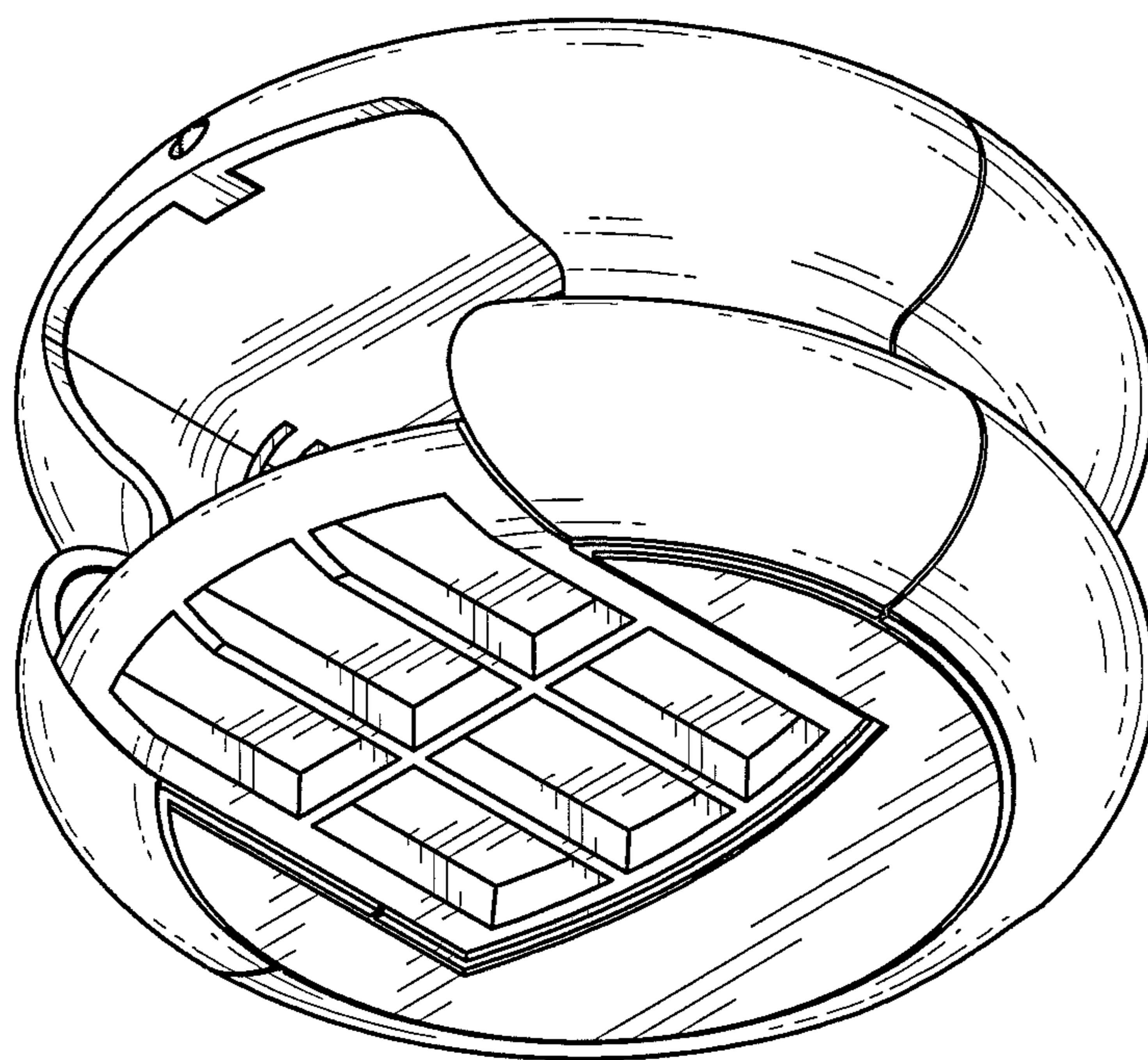

FIG. 8

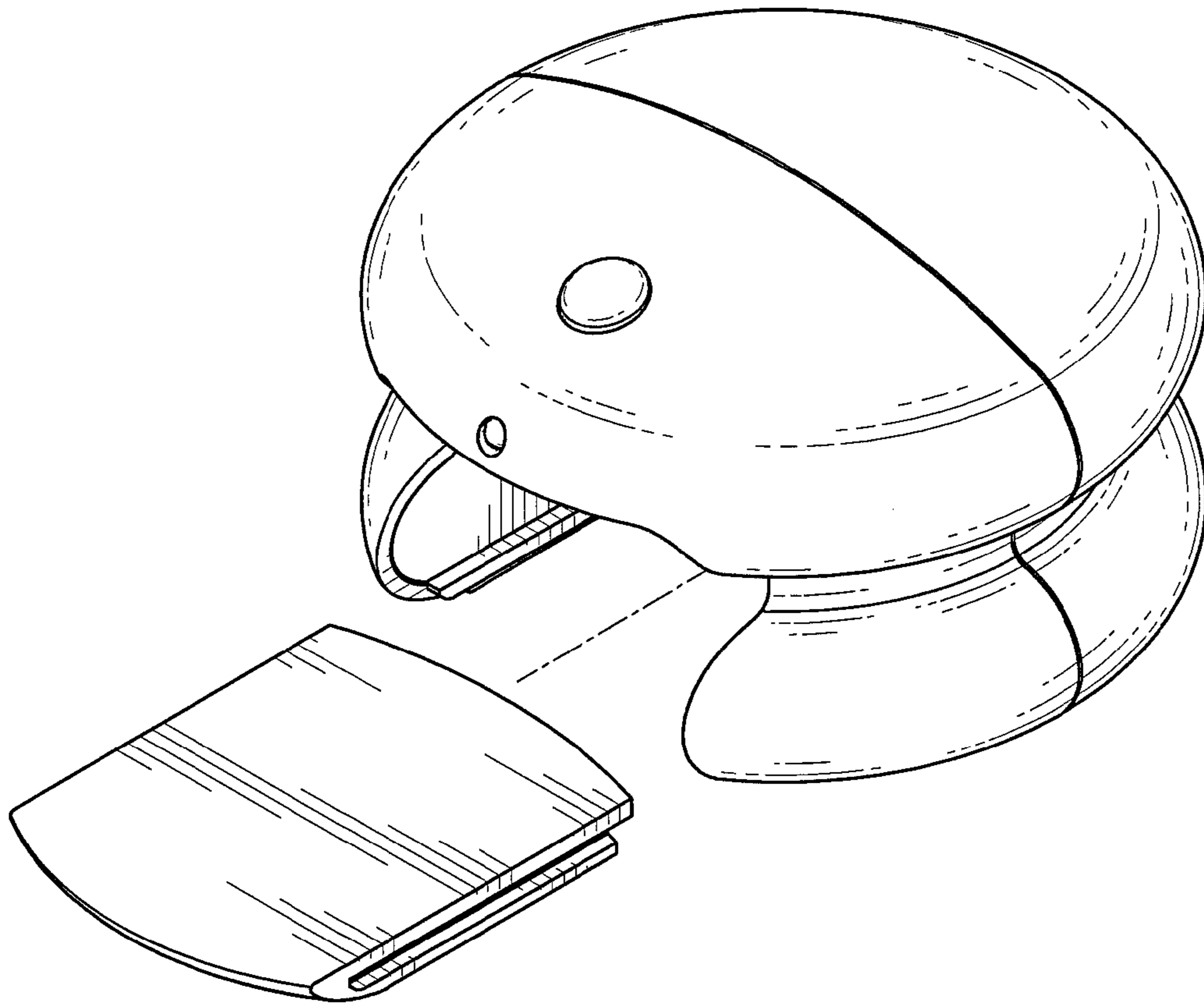

FIG. 9

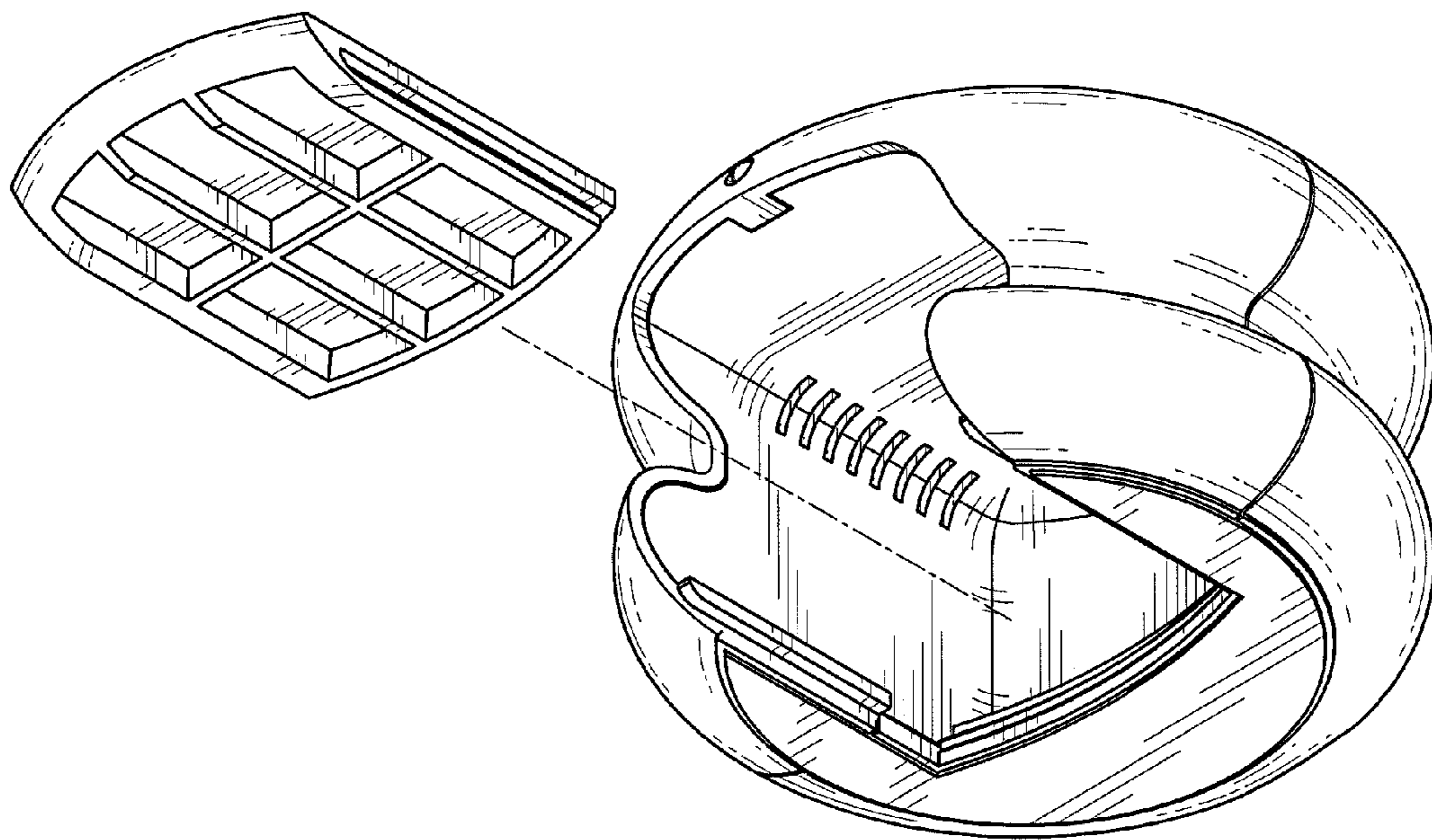

FIG. 10

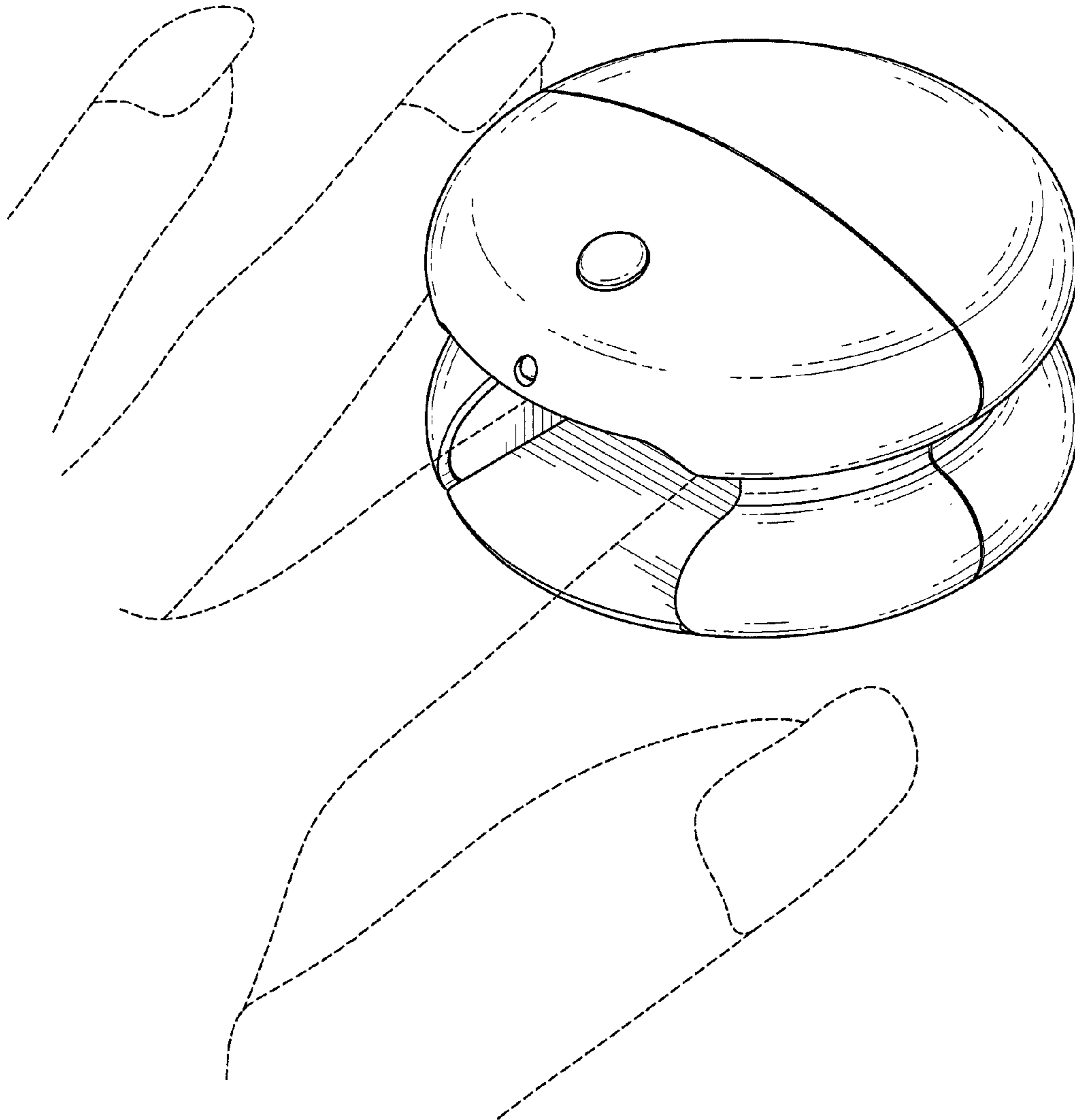

FIG. 11