



US00D704880S

(12) **United States Design Patent**
Johnson

(10) **Patent No.:** **US D704,880 S**

(45) **Date of Patent:** **** May 13, 2014**

(54) **LIGHTED CHANDELIER**

(71) Applicant: **Quorum International, Inc.**, Fort Worth, TX (US)

(72) Inventor: **Aaron M. Johnson**, Albuquerque, NM (US)

(73) Assignee: **Quorum International, Inc.**, Fort Worth, TX (US)

(**) Term: **14 Years**

(21) Appl. No.: **29/470,351**

(22) Filed: **Nov. 5, 2013**

(51) **LOC (10) Cl.** **26-05**

(52) **U.S. Cl.**
USPC **D26/81**

(58) **Field of Classification Search**
CPC F21S 8/06; F21V 27/00; F21V 21/18
USPC D26/81-84, 86, 88, 90, 143, 144,
D26/152-154; 362/147, 404-408, 431, 432
See application file for complete search history.

(56) **References Cited**

U.S. PATENT DOCUMENTS

D63,616 S *	12/1923	Crowell	D26/81
D65,209 S *	7/1924	Wolter	D26/144
D67,051 S *	4/1925	Rosenblatt	D26/81
D69,601 S *	3/1926	Levy	D26/144
D71,025 S *	9/1926	Krause	D26/81
D72,452 S *	4/1927	Seidell	D26/81
D72,511 S *	4/1927	Crumley	D26/81
D73,242 S *	8/1927	Shapiro	D26/81
D74,190 S *	1/1928	Rosenblatt	D26/144
D79,254 S *	8/1929	Rosenblatt	D26/144

D372,321 S *	7/1996	Hammar	D26/84
D432,256 S *	10/2000	Dolan	D26/84
D572,859 S *	7/2008	Brookins	D26/81

OTHER PUBLICATIONS

Chandelier #17036/4 from the Sullivan Collection shown on p. 190 of the E.L.K. Lighting Inc. Catalog 2900. © 2009. (2 pages, includes rear cover of catalog).*

6 lite pendant #14570-018 from the Seraphine Collection shown on p. 187 of the Eurofase Lighting Classics Catalog #MKT-CAT-CL09. © 2009. (2 pages, includes rear cover of catalog).*

* cited by examiner

Primary Examiner — Clare E Heflin

(74) *Attorney, Agent, or Firm* — Charles D. Gunter, Jr.

(57) **CLAIM**

The ornamental design for a lighted chandelier, as shown and described.

DESCRIPTION

FIG. 1 is a bottom, perspective view of the lighted chandelier of the invention;

FIG. 2 is a front, side view of the lighted chandelier of FIG. 1; FIG. 3 is a back, side view of the lighted chandelier fan of FIG. 1;

FIG. 4 is a right, side view of the lighted chandelier of the invention;

FIG. 5 is a left, side view of the lighted chandelier of the invention;

FIG. 6 is a top view of the lighted chandelier of the invention;

FIG. 7 is a bottom view of the lighted chandelier of the invention; and,

FIG. 8 is a top, perspective view of the lighted chandelier of the invention.

1 Claim, 8 Drawing Sheets

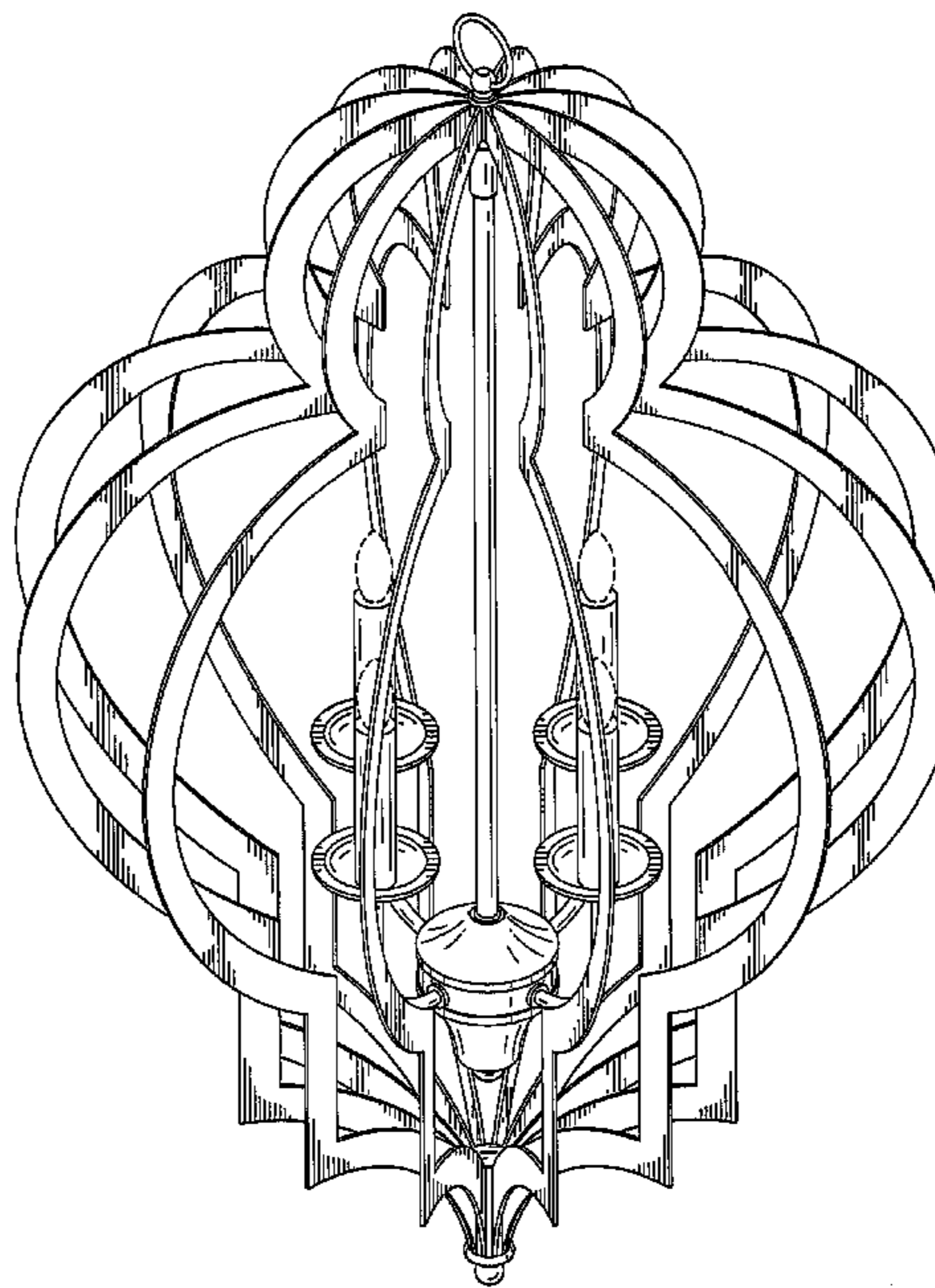
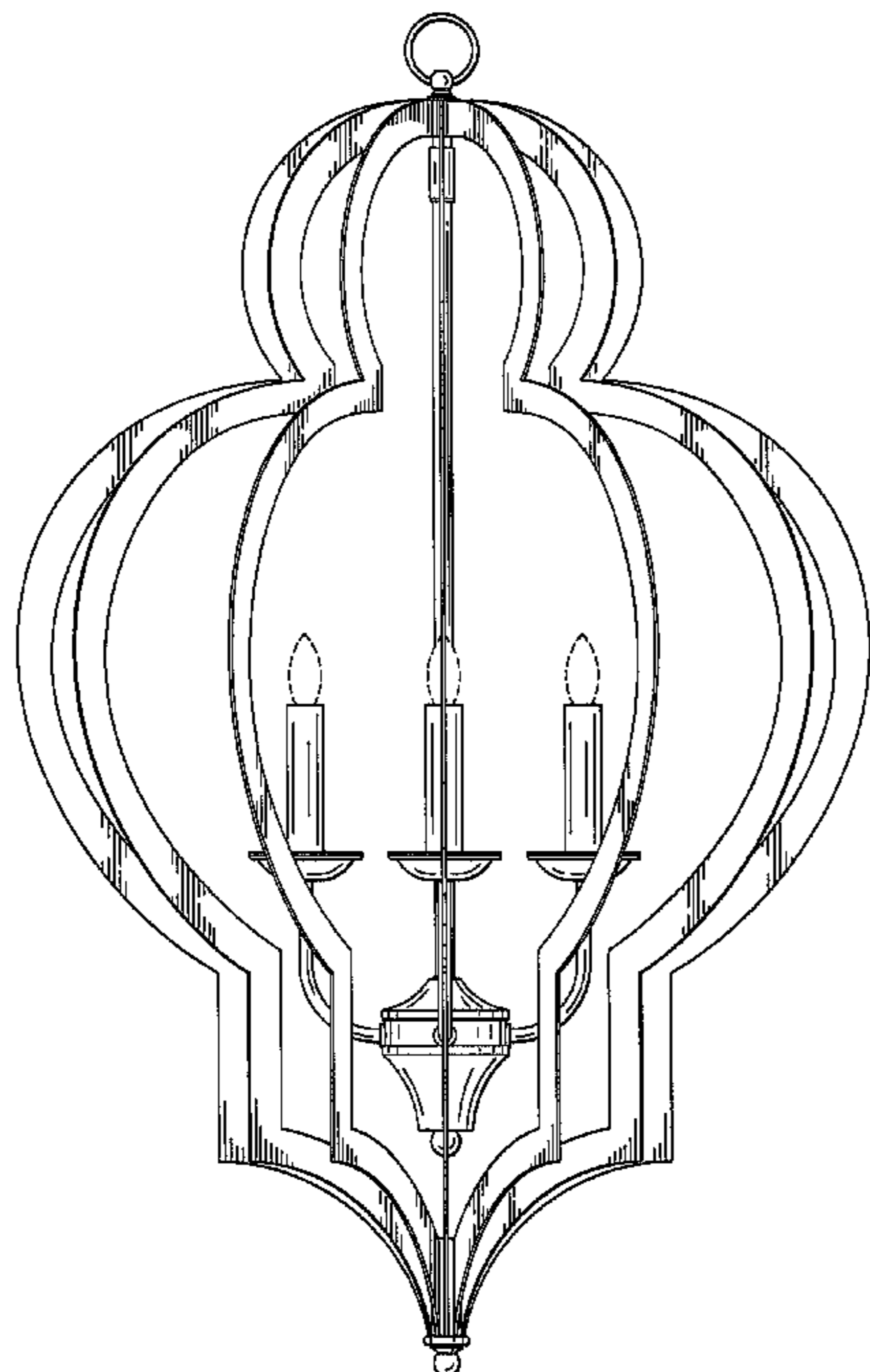

FIG. 1

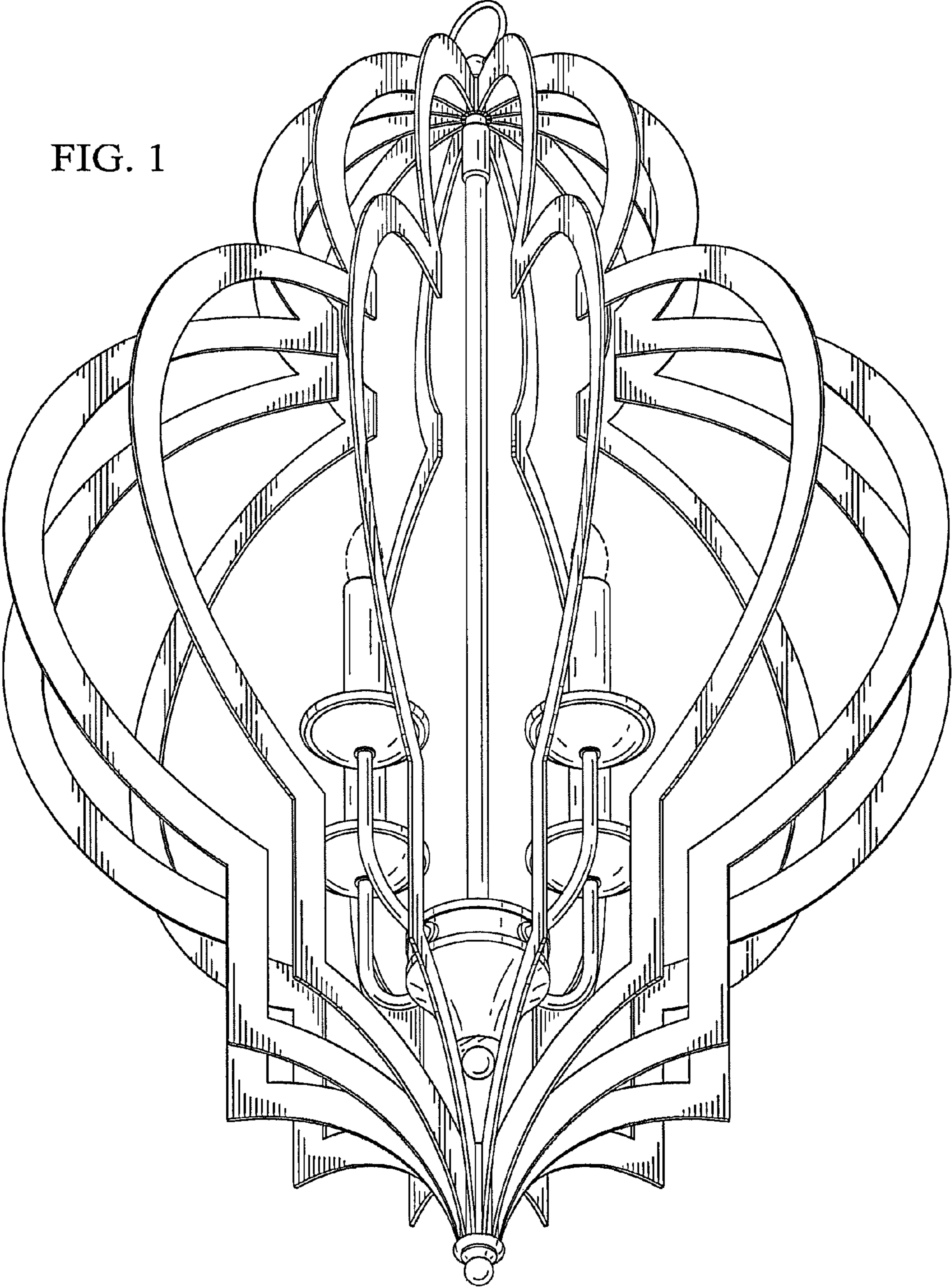

FIG. 2

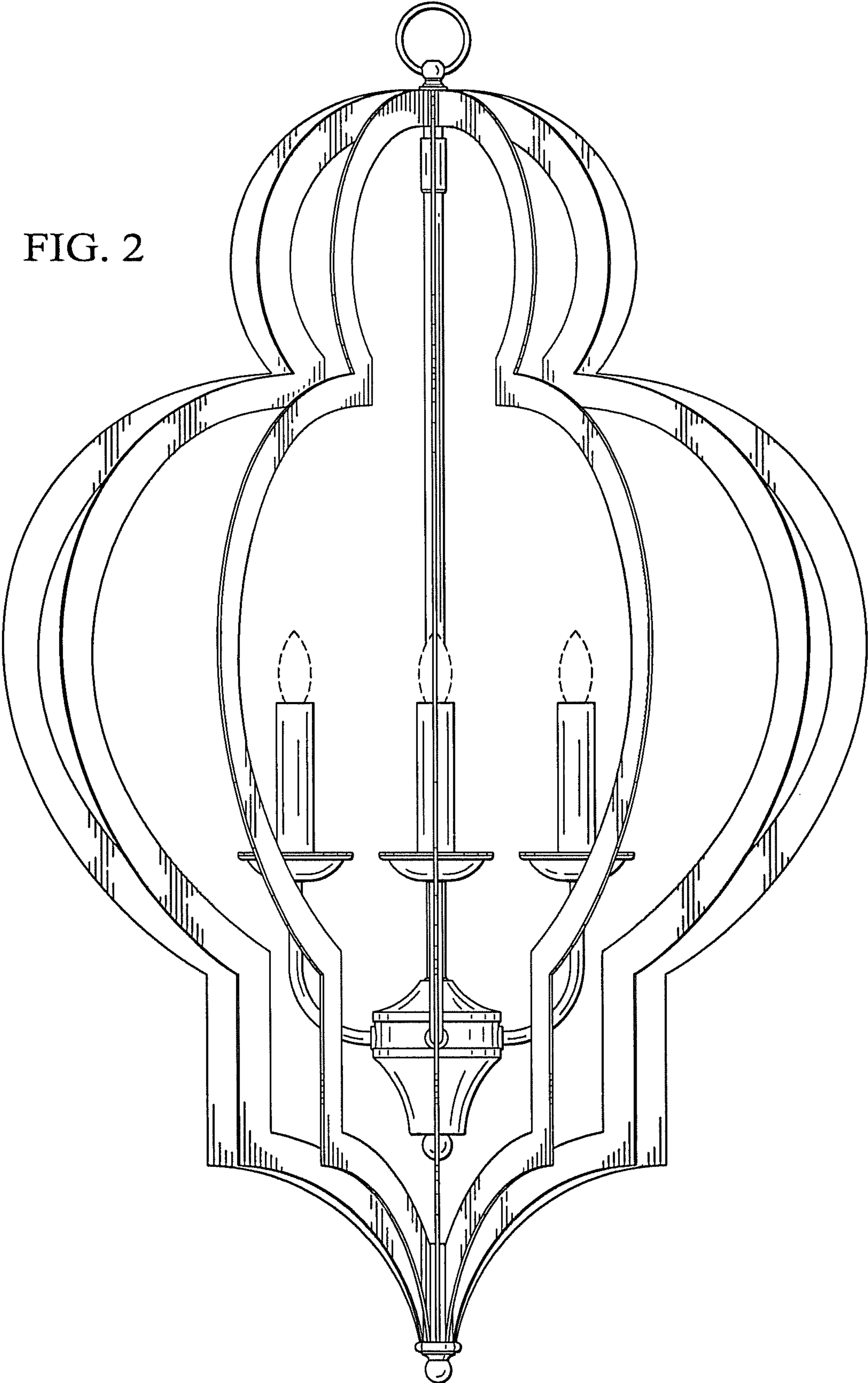

FIG. 3

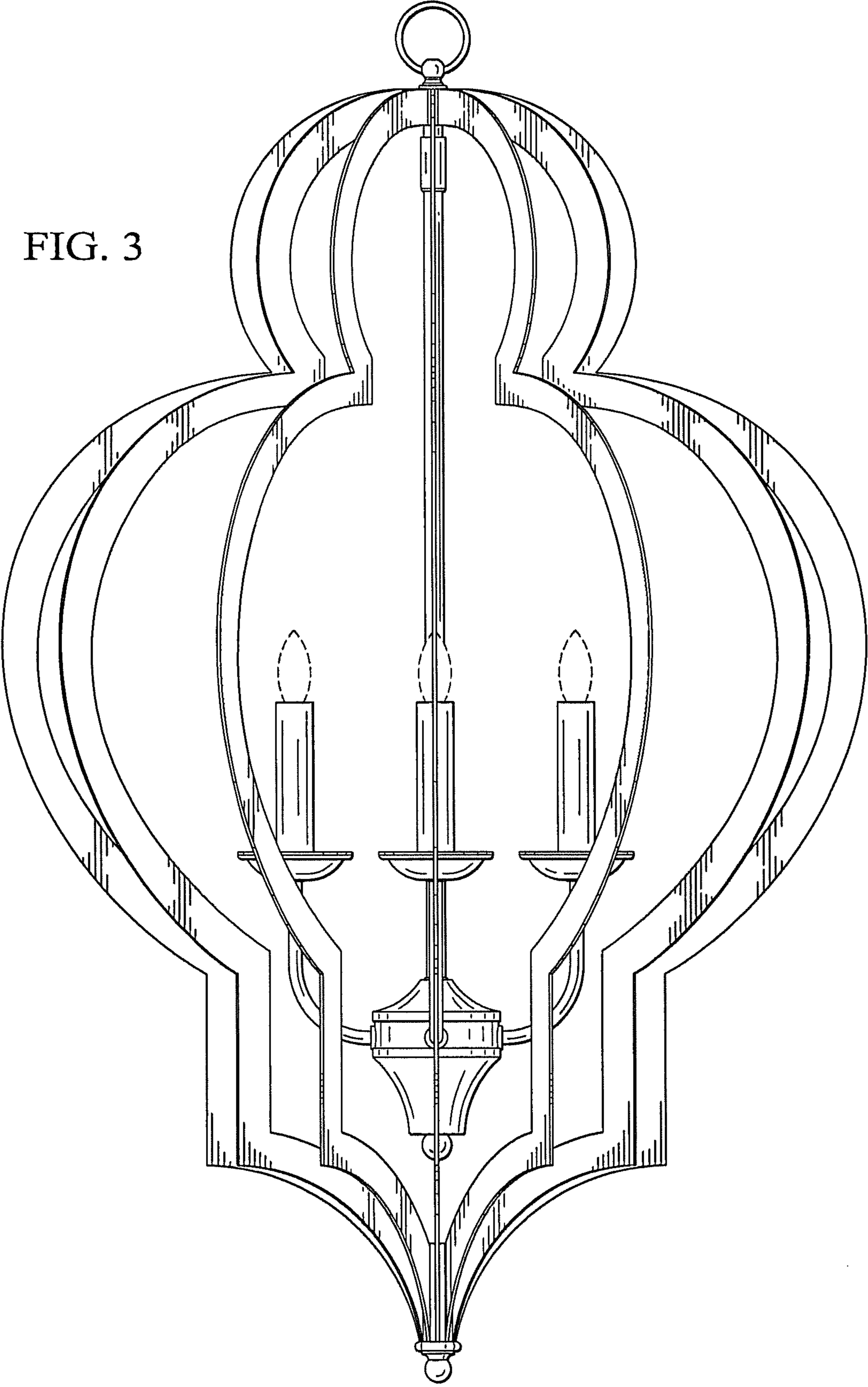

FIG. 4

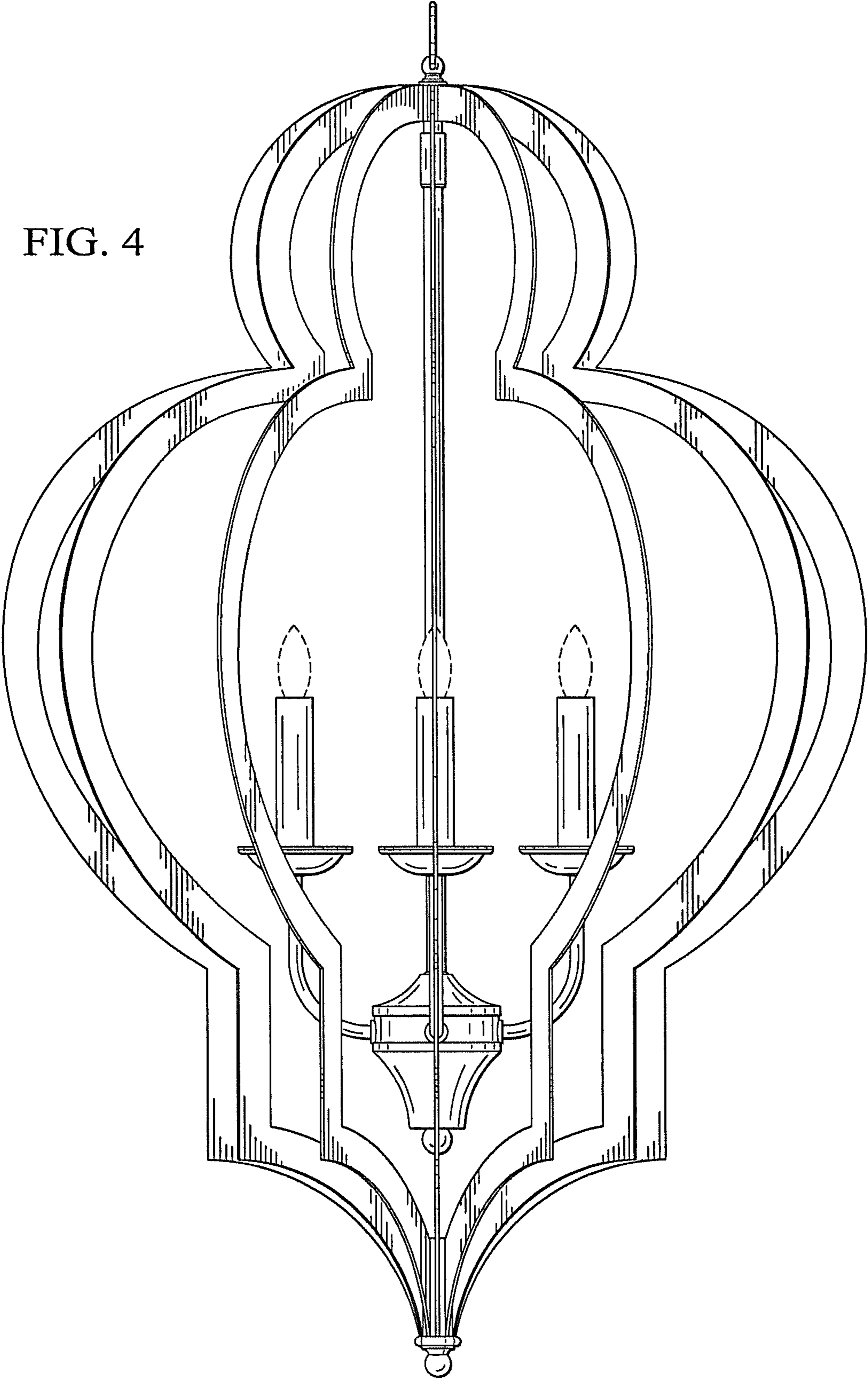

FIG. 5

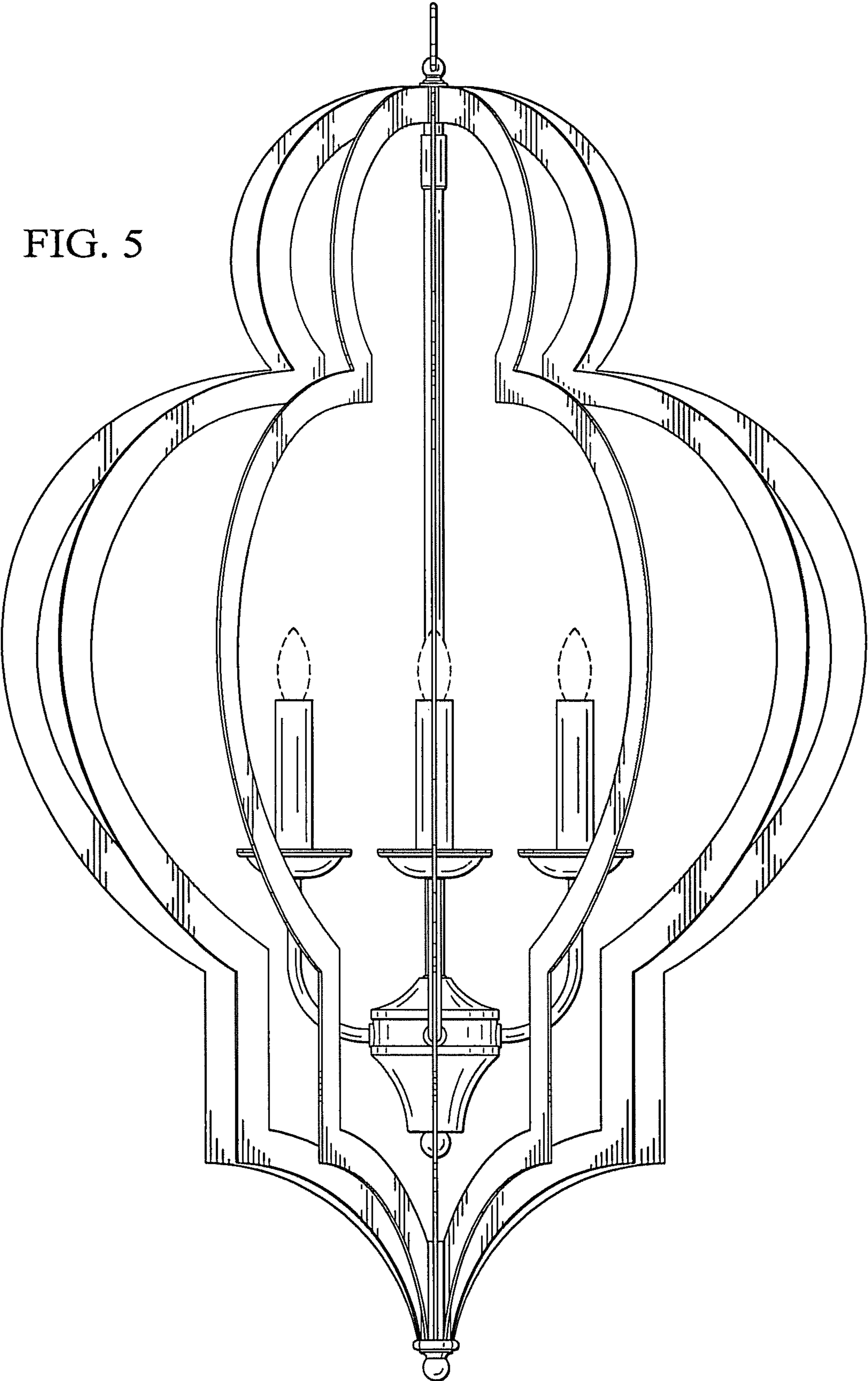

FIG. 6

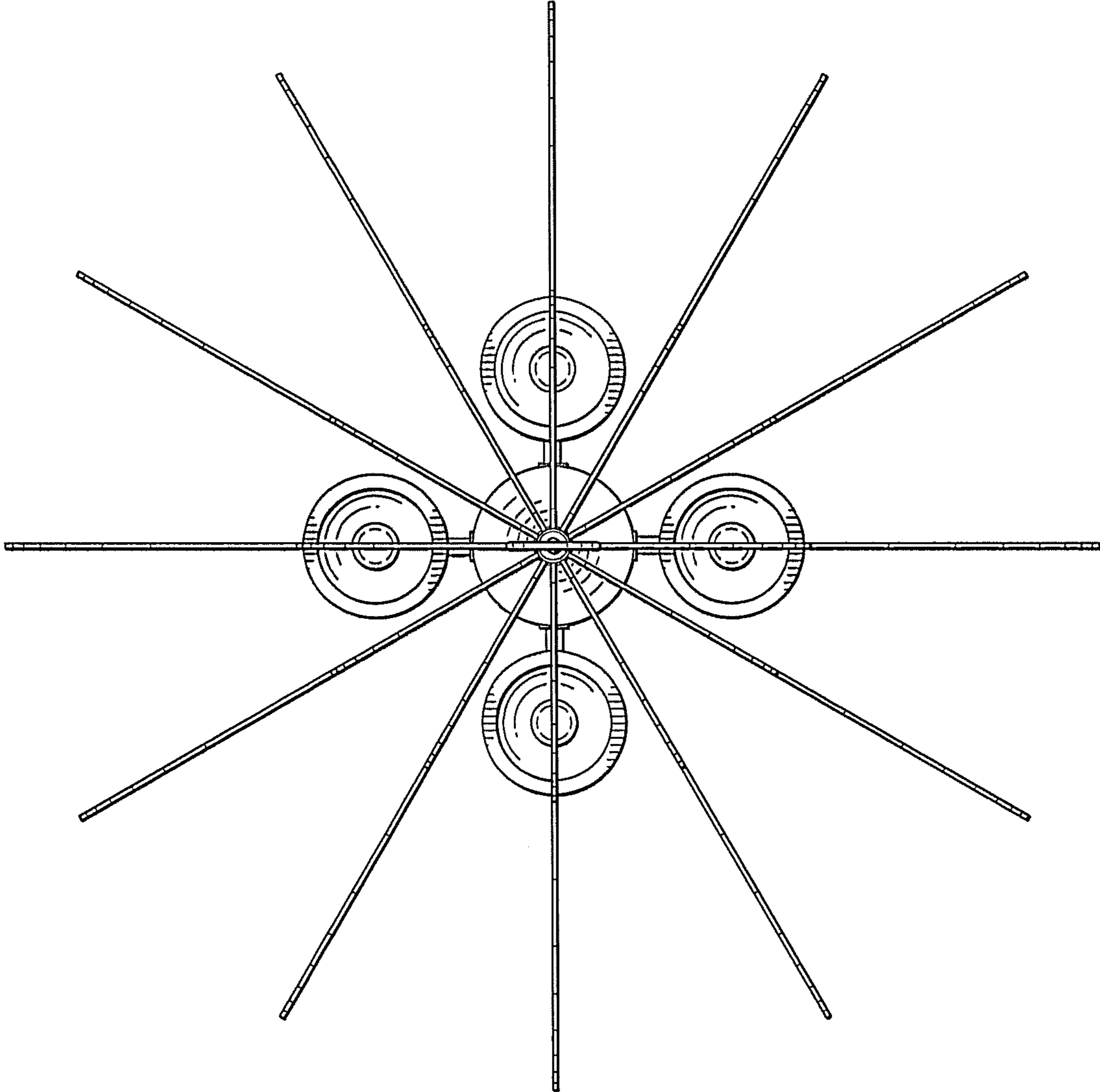

FIG. 7

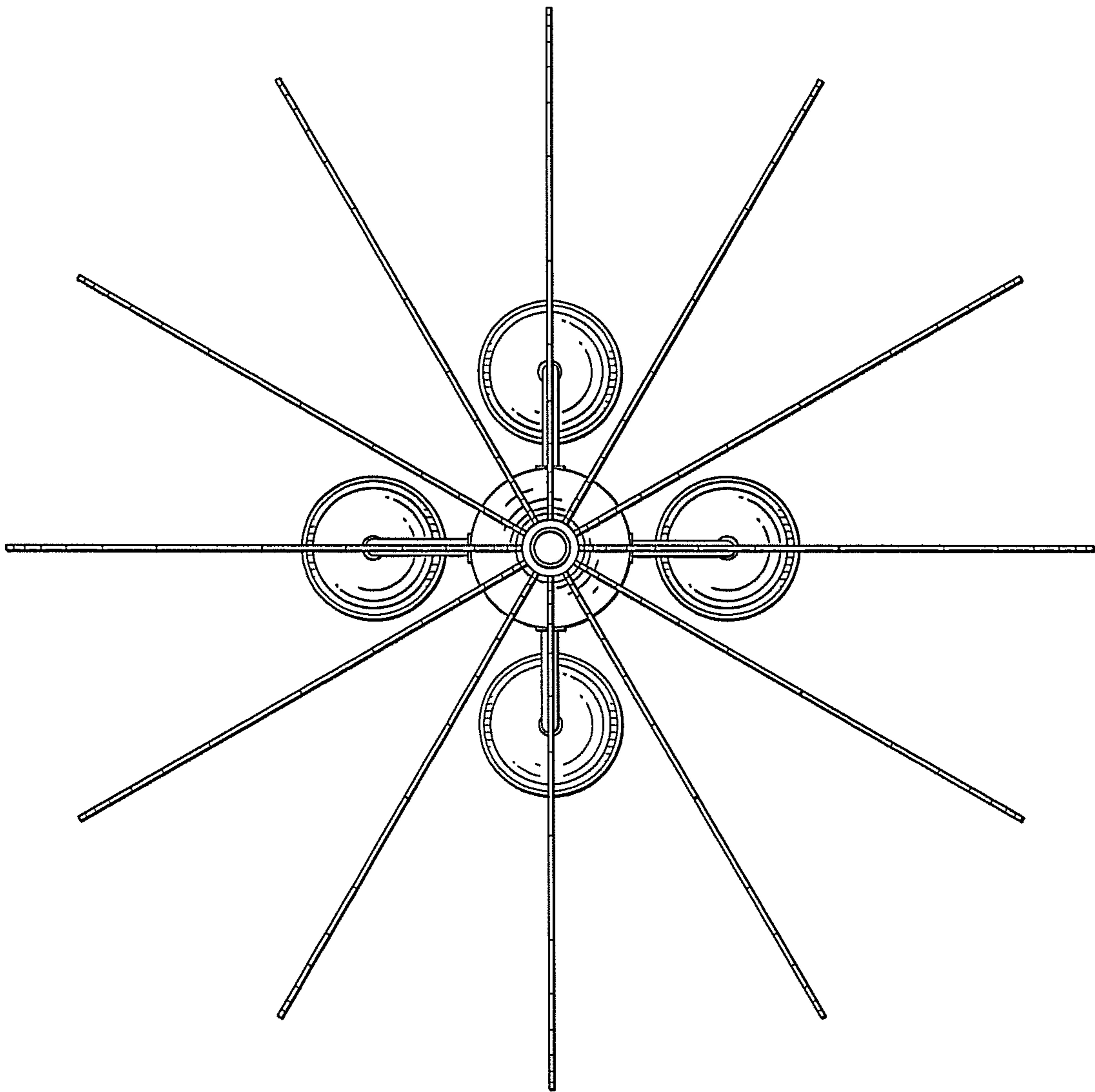

FIG. 8

