



US00D704858S

(12) **United States Design Patent**
Green

(10) **Patent No.:** **US D704,858 S**

(45) **Date of Patent:** **** May 13, 2014**

(54) **WORK PLATFORM**

(71) Applicant: **Lock N Climb, LLC**, Bartlesville, OK
(US)

(72) Inventor: **Jeffrey Alan Green**, Bartlesville, OK
(US)

(73) Assignee: **Lock N Climb, LLC**, Bartlesville, OK
(US)

(**) Term: **14 Years**

(21) Appl. No.: **29/439,796**

(22) Filed: **Dec. 14, 2012**

(51) **LOC (10) Cl.** **25-04**

(52) **U.S. Cl.**
USPC **D25/62**

(58) **Field of Classification Search**
USPC D25/62; 182/179.1, 181.1, 186.9, 222,
182/153

See application file for complete search history.

(56) **References Cited**

U.S. PATENT DOCUMENTS

5,626,205	A *	5/1997	Martin	182/153
5,984,047	A *	11/1999	Rogers	182/153
6,892,860	B2 *	5/2005	Gibson et al.	182/222
D596,317	S *	7/2009	Favell	D25/62
2006/0130715	A1 *	6/2006	Yoo et al.	108/116

* cited by examiner

Primary Examiner — Doris Clark

(74) *Attorney, Agent, or Firm* — Michael Stanley Tomsa;
Katten Muchin Rosenman LLP

(57) **CLAIM**

The ornamental design for the work platform, as shown and described.

DESCRIPTION

FIG. 1 is a top perspective view of the work platform with the legs extended;

FIG. 2 is a bottom perspective view with one leg partially retracted;

FIG. 3 is a left side elevation view with the legs extended;

FIG. 4 is a left side elevation view thereof with legs retracted;

FIG. 5 is a right side elevation view with the legs extended;

FIG. 6 is a right side elevation view thereof with the legs retracted;

FIG. 7 is a right end elevation view with the legs extended;

FIG. 8 is a right end elevation view thereof with the legs retracted;

FIG. 9 is a left end elevation view with the legs extended;

FIG. 10 is a left end elevation view thereof with the legs retracted;

FIG. 11 is a top plan view;

FIG. 12 is a bottom plan view with the legs extended; and,

FIG. 13 is a bottom plan view thereof with the legs retracted.
The broken lines shown in the views are for illustrative purposes only and form no part of the claimed design.

1 Claim, 9 Drawing Sheets

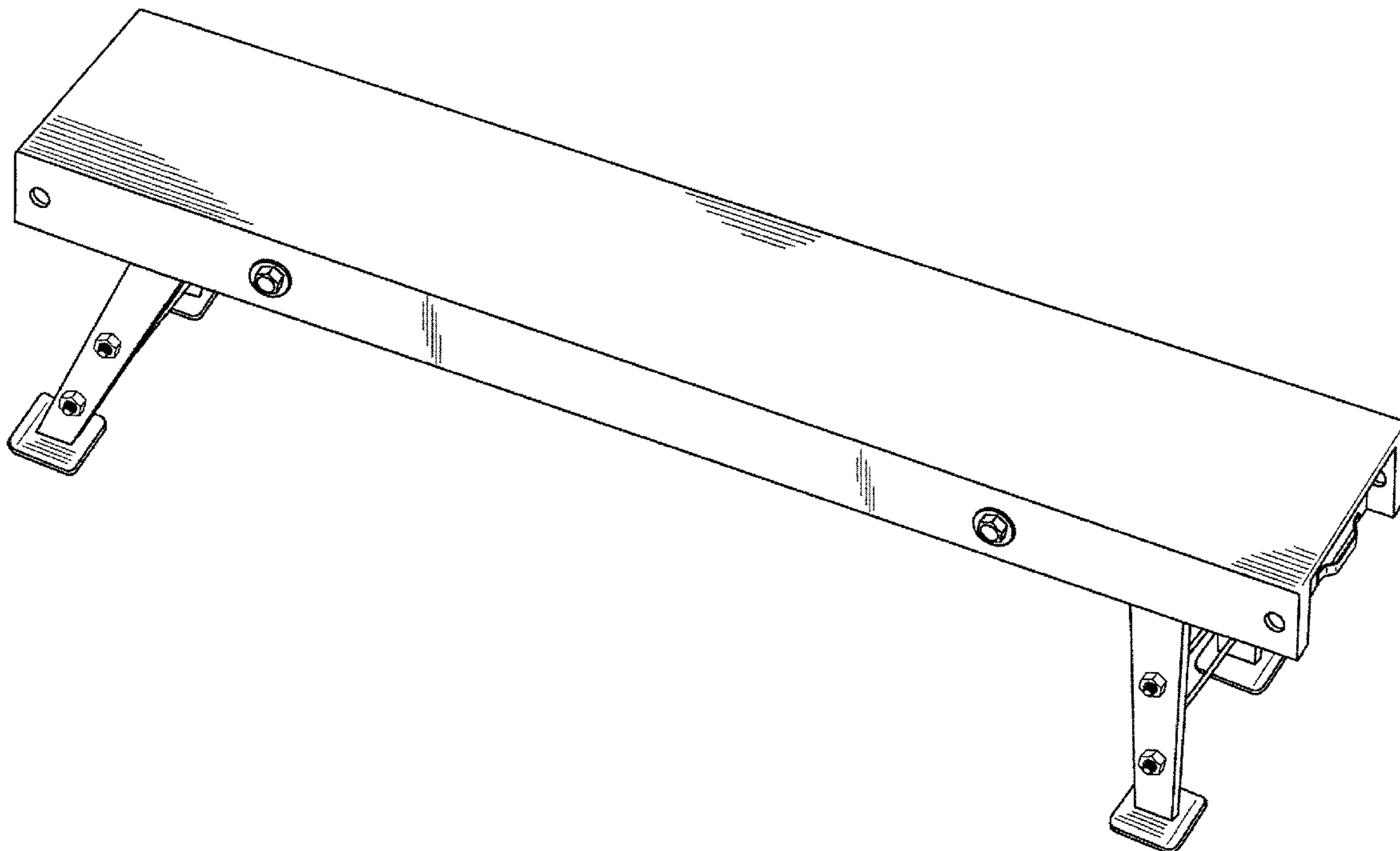

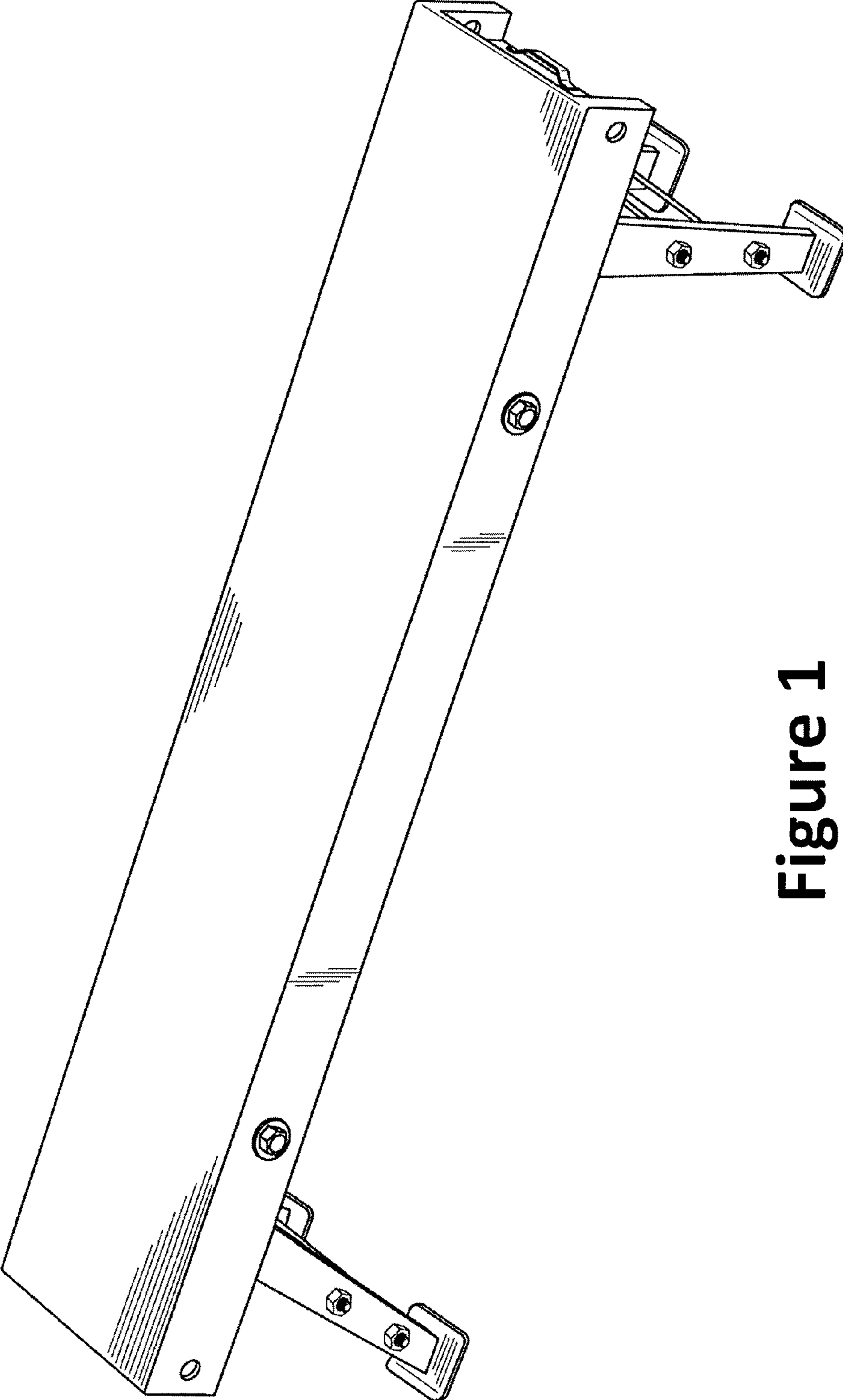

Figure 1

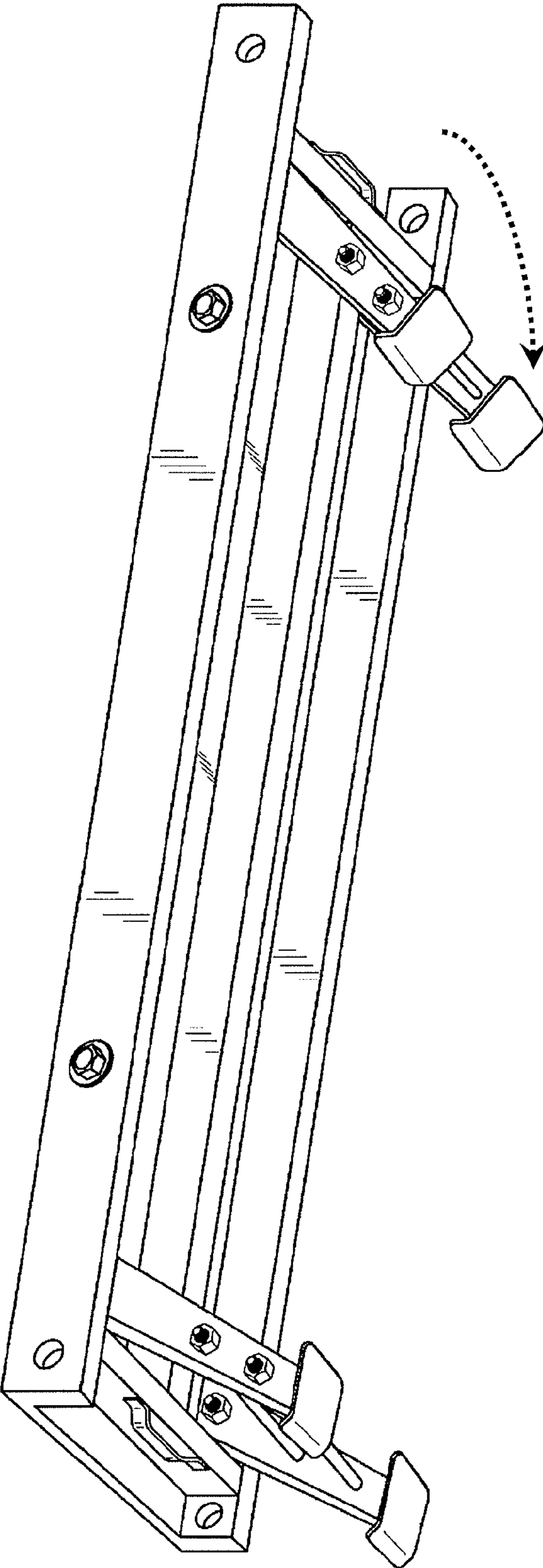

Figure 2

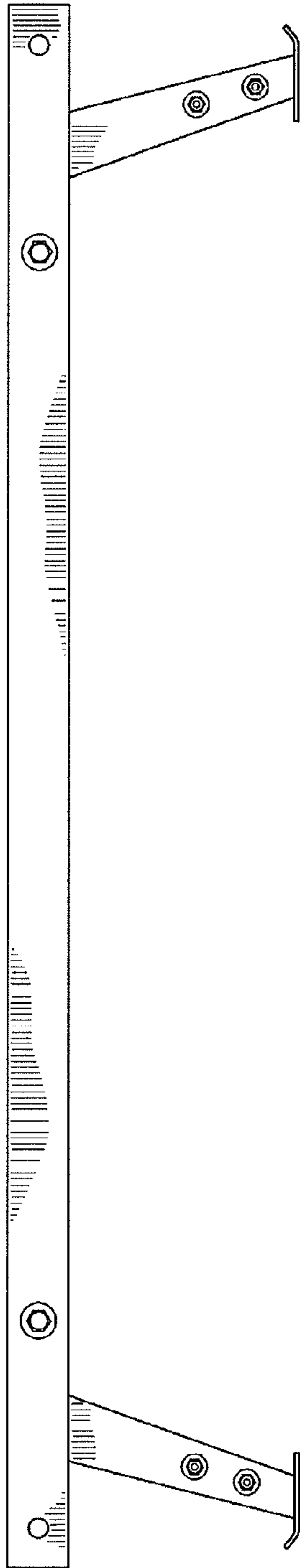

Figure 3



Figure 4

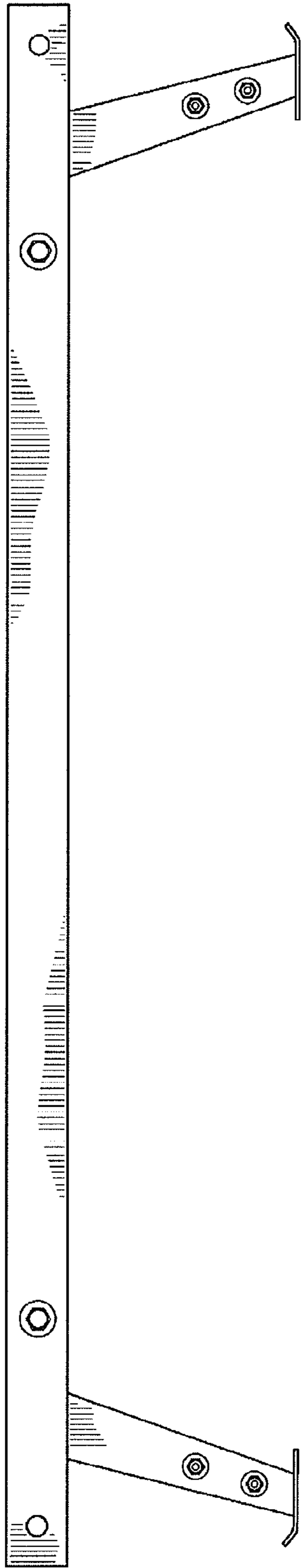

Figure 5



Figure 6

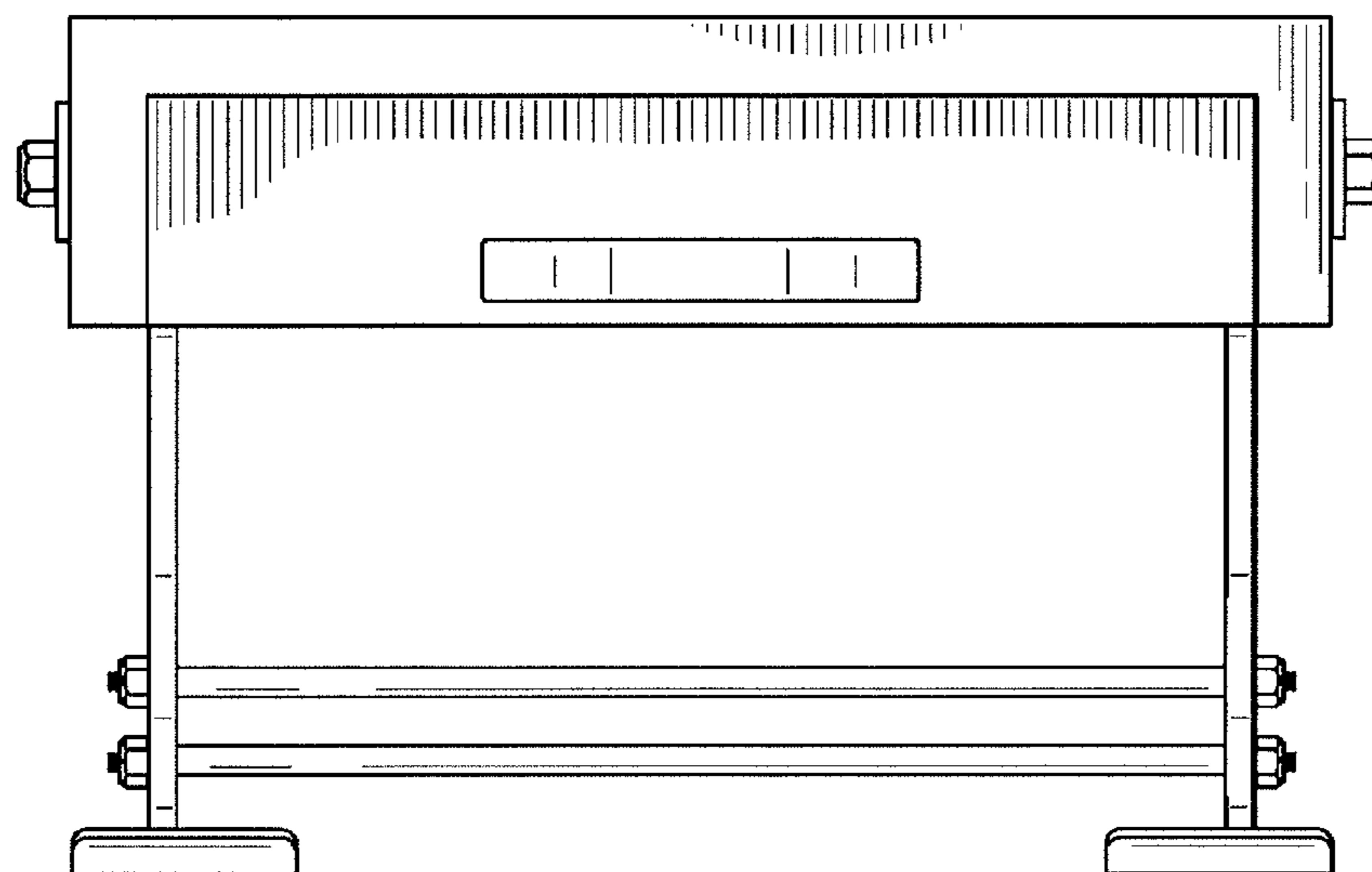

Figure 7

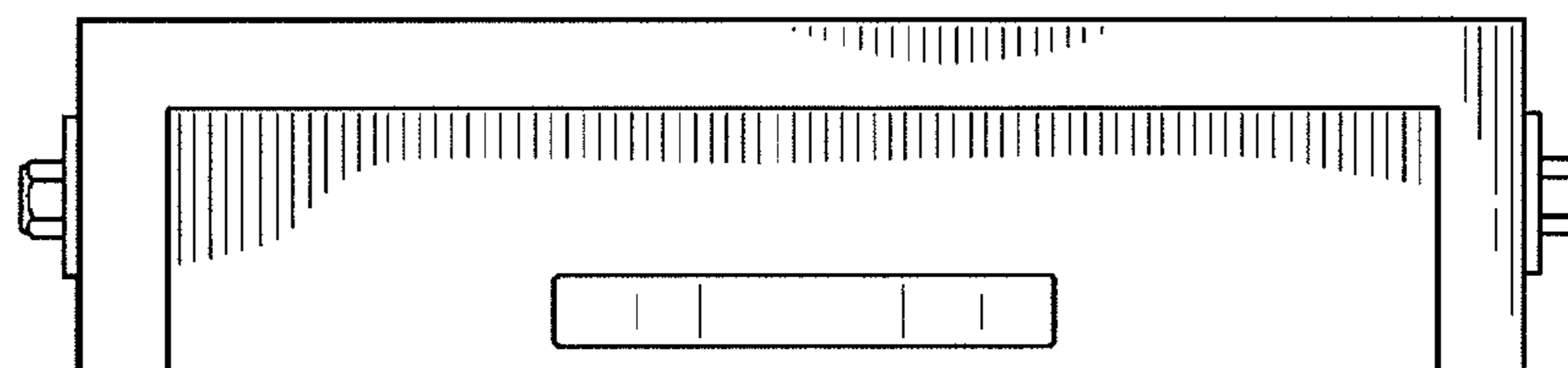

Figure 8

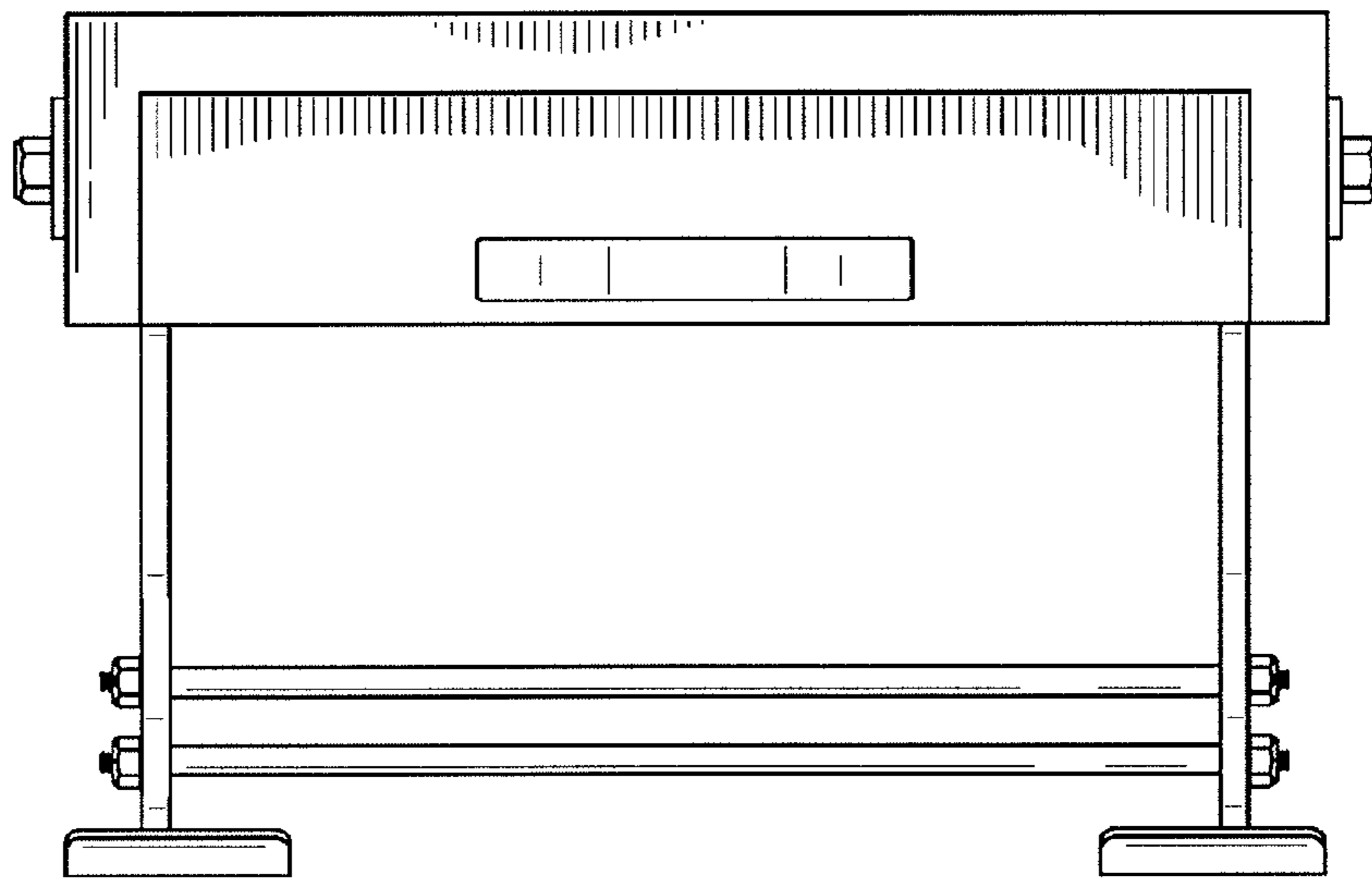

Figure 9

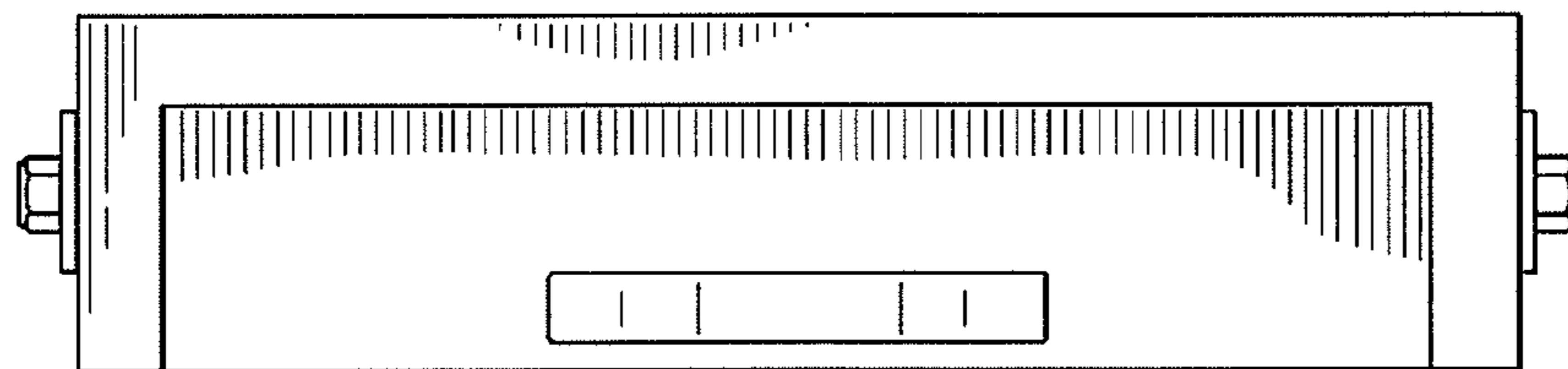

Figure 10

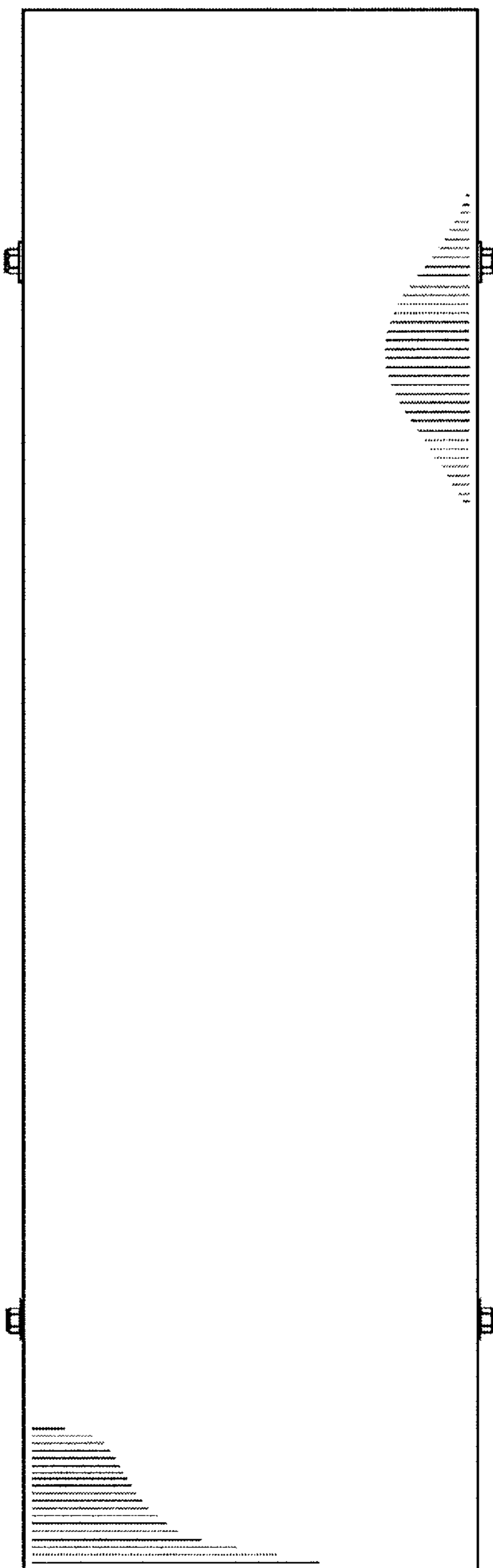

Figure 11

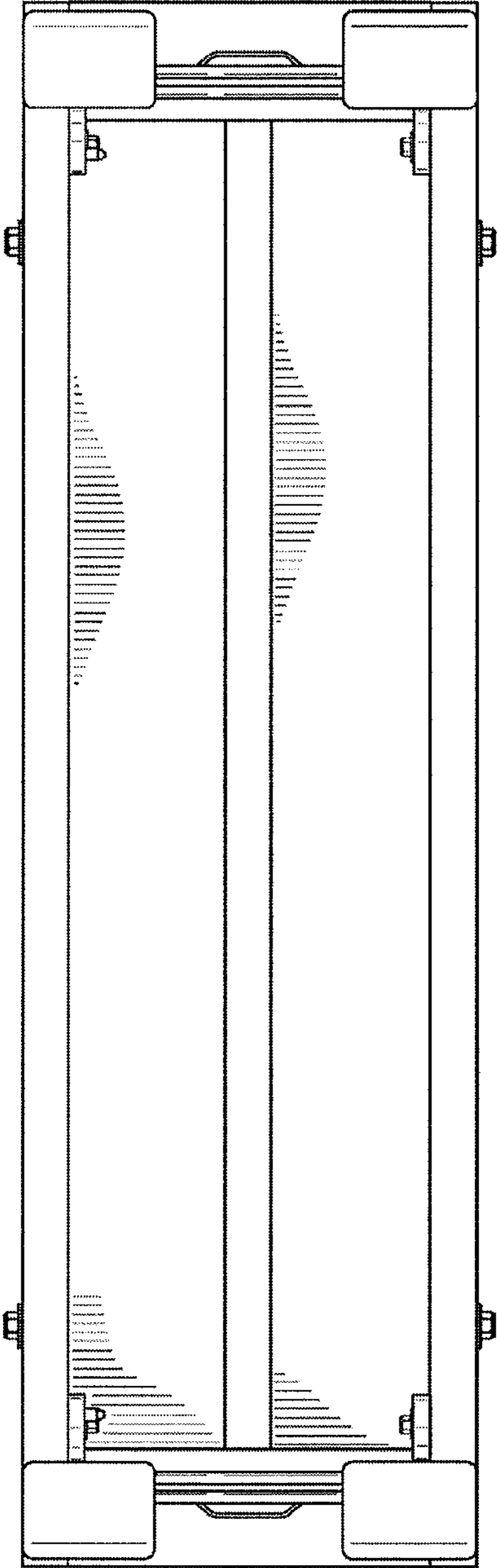

Figure 12

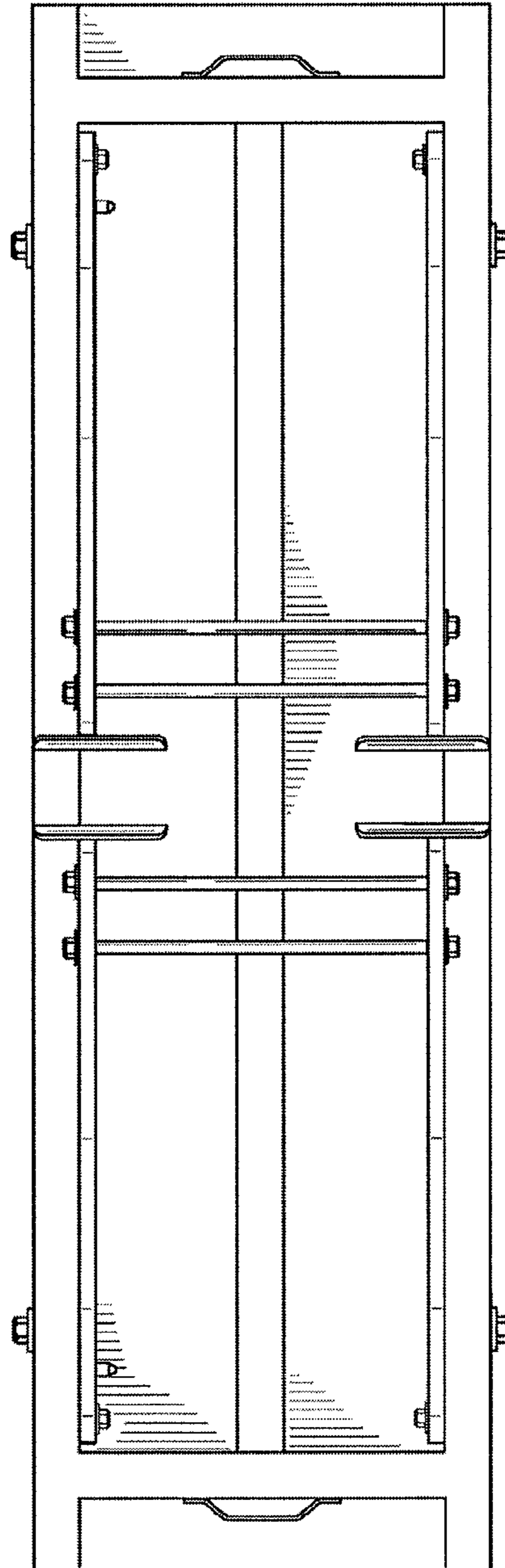

Figure 13