



US00D704842S

(12) **United States Design Patent**
Wood et al.

(10) **Patent No.:** **US D704,842 S**

(45) **Date of Patent:** **** May 13, 2014**

(54) **OPHTHALMOSCOPE**

D635,257 S * 3/2011 Ellman D24/137
7,963,653 B1 * 6/2011 Ellman 351/218
D649,636 S * 11/2011 Bean et al. D24/133

(71) Applicant: **Welch Allyn, Inc.**, Skaneateles Falls, NY
(US)

(72) Inventors: **Robert J. Wood**, Syracuse, NY (US);
Michael McAtamney, Navan (IE);
James J. Shortt, Trim (IE); **Stephen A
Montgomery**, Virginia (IE)

OTHER PUBLICATIONS
[http://www.mystethoscope.com/welch-allyn-halogen-pocketscope-ophthalmoscope-p-153 . . . *](http://www.mystethoscope.com/welch-allyn-halogen-pocketscope-ophthalmoscope-p-153...)
[http://www.zumaxmedical.com/ophthalmoscope_1.htm.*](http://www.zumaxmedical.com/ophthalmoscope_1.htm)
[http://www.medicalexpo.com/prod/rudolf-riester/direct-ophthalmoscopes-69880-517092.h . . . *](http://www.medicalexpo.com/prod/rudolf-riester/direct-ophthalmoscopes-69880-517092.h...)

(73) Assignee: **Welch Allyn, Inc.**, Skaneateles Falls, NY
(US)

* cited by examiner

(**) Term: **14 Years**

Primary Examiner — Robert M Spear

Assistant Examiner — Rhea Shields

(21) Appl. No.: **29/440,342**

(74) *Attorney, Agent, or Firm* — Merchant & Gould P.C.

(22) Filed: **Dec. 20, 2012**

(51) **LOC (10) Cl.** **24-03**

(52) **U.S. Cl.**
USPC **D24/172**

(57) **CLAIM**
The ornamental design for an ophthalmoscope, as shown and described.

(58) **Field of Classification Search**
USPC D24/137, 138, 140, 150, 157, 225, 160,
D24/162, 166, 172, 174, 177, 183, 185, 186,
D24/199, 216, 227, 230, 231, 232, 234,
D24/454; D21/306; 351/200–203, 218, 221,
351/224, 243, 246, 239

DESCRIPTION

See application file for complete search history.

FIG. 1 is a perspective view of the ophthalmoscope;
FIG. 2 is a front view;
FIG. 3 is a back view;
FIG. 4 is a right side view;
FIG. 5 is a left side view;
FIG. 6 is a top view; and,
FIG. 7 is a bottom view.
The broken lines in FIGS. 1-7 illustrate unclaimed features of the ophthalmoscope that form no part of the claimed design.

(56) **References Cited**

U.S. PATENT DOCUMENTS

4,643,546 A * 2/1987 Richards 351/205
5,200,772 A * 4/1993 Perkins et al. 351/213
D429,333 S * 8/2000 Sanders et al. D24/137

1 Claim, 6 Drawing Sheets

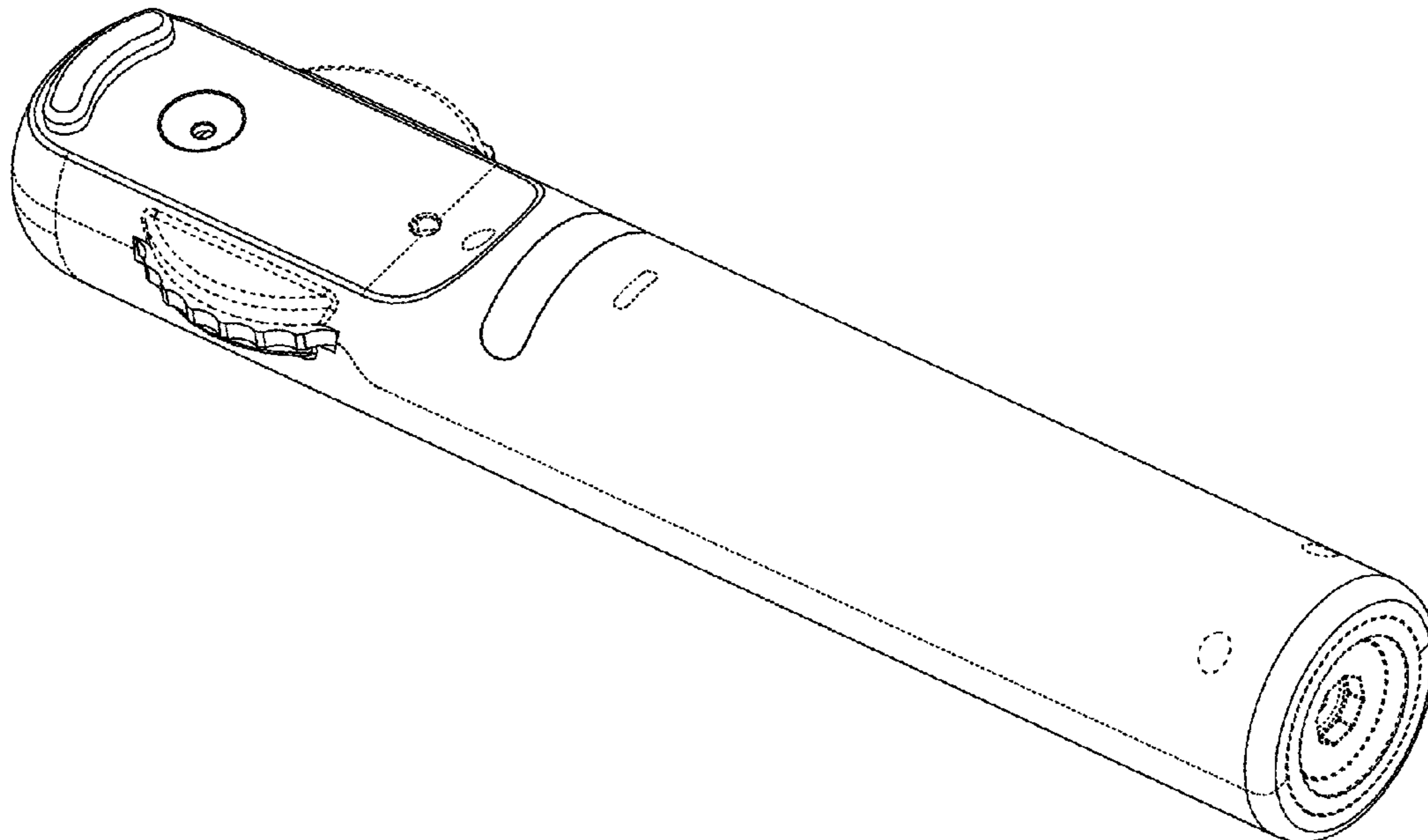

FIG. 1

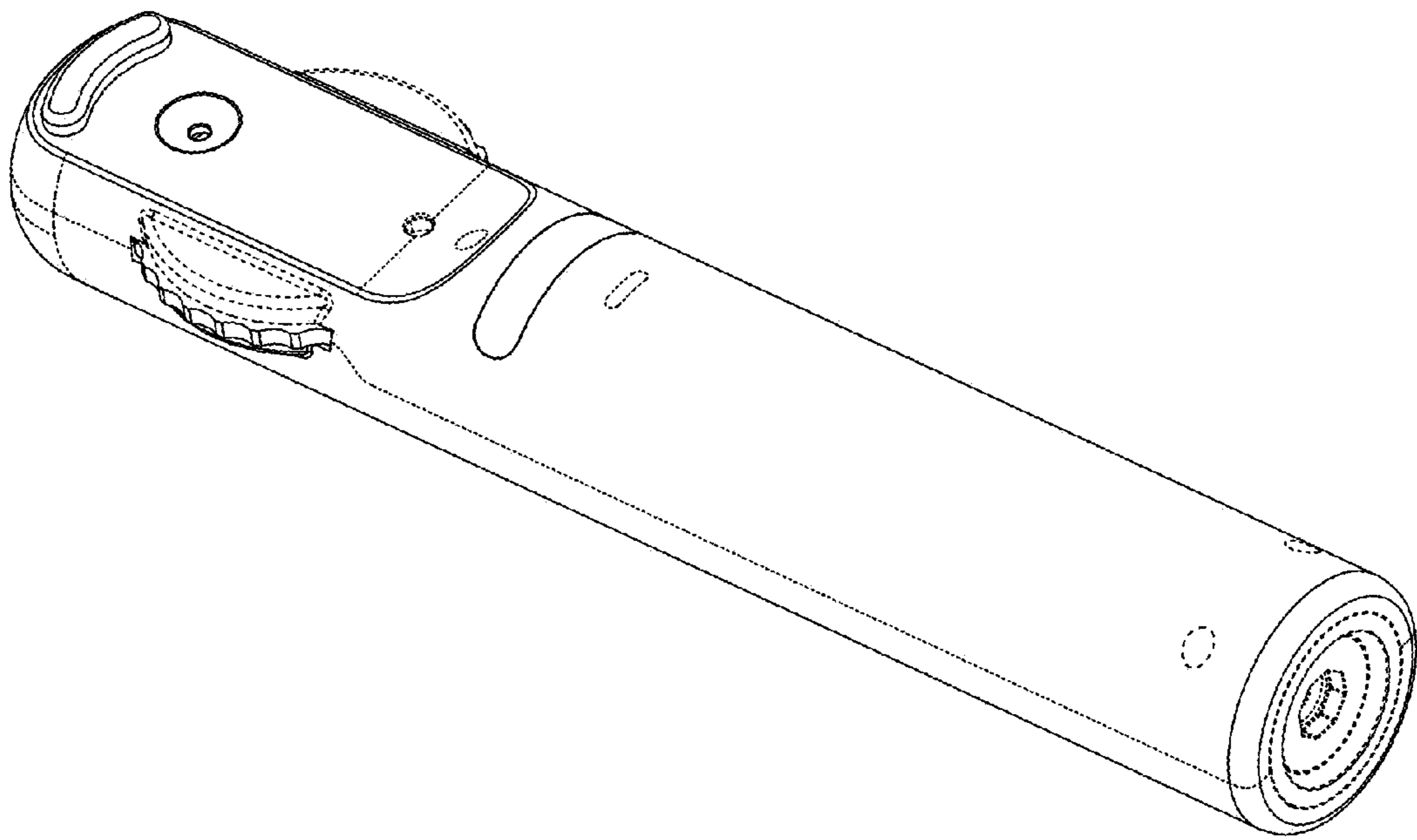

FIG. 2

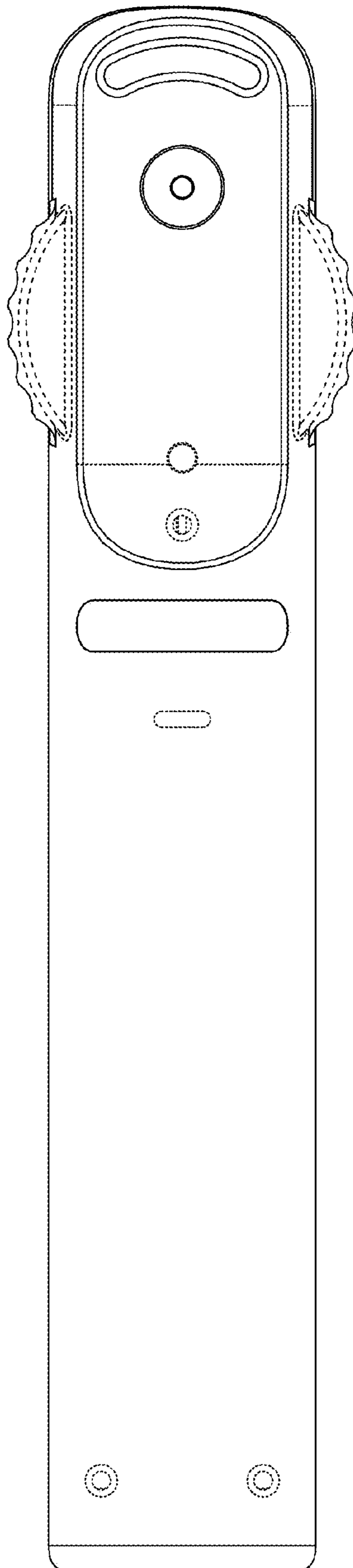

FIG. 3

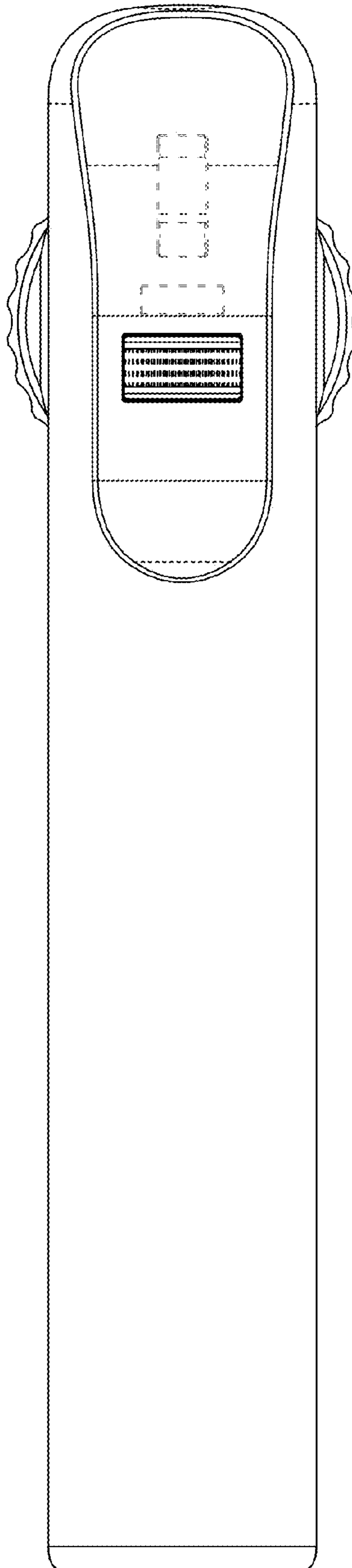

FIG. 4

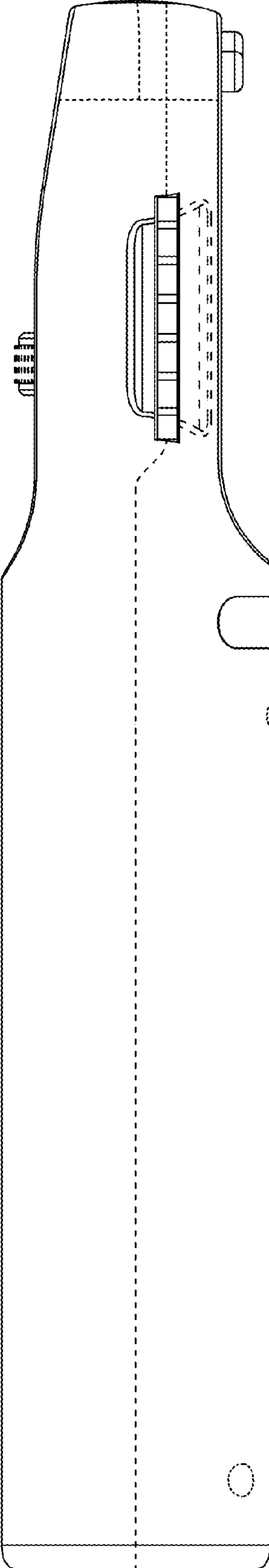

FIG. 5

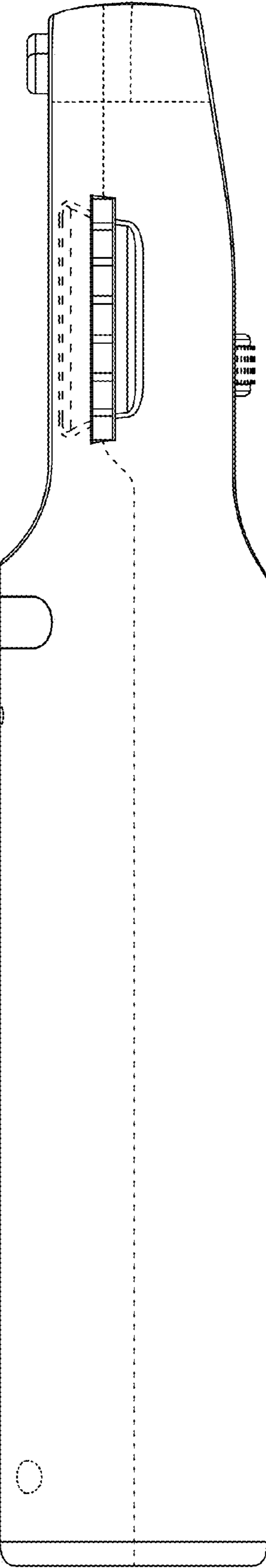

FIG. 6

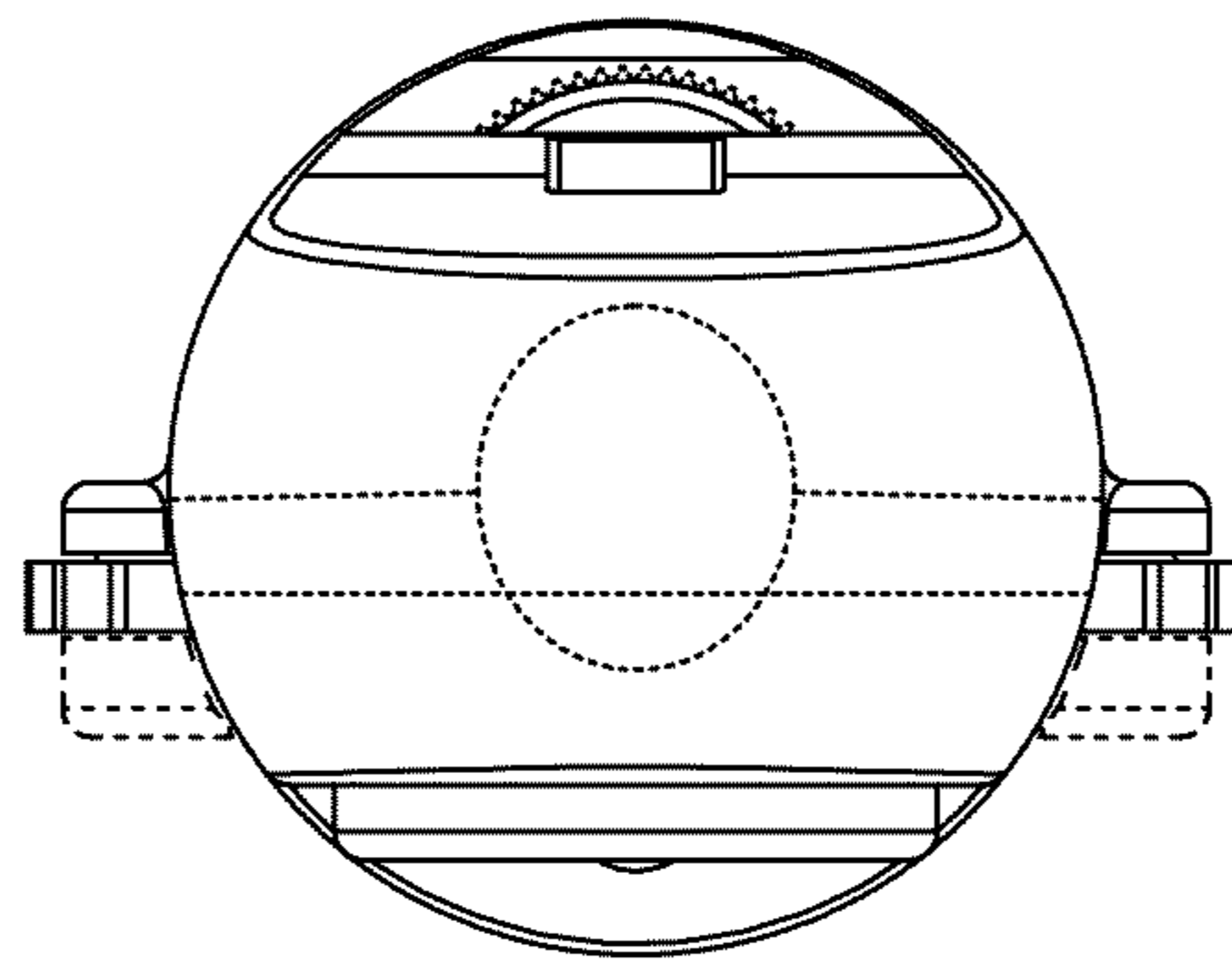

FIG. 7

